

Air-Conditioners For Building Application**INDOOR UNIT****CE****MASTER BC CONTROLLER
CMB-P-V-GA****INSTALLATION MANUAL**

For safe and correct use, please read this installation manual thoroughly before installing the air-conditioner unit.

INSTALLATIONSHANDBUCH

Zum sicheren und ordnungsgemäßen Gebrauch der Klimageräte das Installationshandbuch gründlich durchlesen.

MANUEL D'INSTALLATION

Veillez lire le manuel d'installation en entier avant d'installer ce climatiseur pour éviter tout accident et vous assurer d'une utilisation correcte.

MANUAL DE INSTALACIÓN

Para un uso seguro y correcto, lea detalladamente este manual de instalación antes de montar la unidad de aire acondicionado.

MANUALE DI INSTALLAZIONE

Per un uso sicuro e corretto, leggere attentamente questo manuale di installazione prima di installare il condizionatore d'aria.

INSTALLATIEHANDLEIDING

Voor een veilig en juist gebruik moet u deze installatiehandleiding grondig doorlezen voordat u de airconditioner installeert.

MANUAL DE INSTALAÇÃO

Para segurança e utilização correctas, leia atentamente este manual de instalação antes de instalar a unidade de ar condicionado.

ΕΓΧΕΙΡΙΔΙΟ ΟΔΗΓΙΩΝ ΕΓΚΑΤΑΣΤΑΣΗΣ

Για ασφάλεια και σωστή χρήση, παρακαλείσθε διαβάσετε προσεχτικά αυτό το εγχειρίδιο εγκατάστασης πριν αρχίσετε την εγκατάσταση της μονάδας κλιματισμού.

РУКОВОДСТВО ПО УСТАНОВКЕ

Для осторожного и правильного использования прибора необходимо тщательно ознакомиться с данным руководством по установке до выполнения установки кондиционера.

MONTAJ ELKİTABI

Emniyetli ve doğru biçimde nasıl kullanılacağını öğrenmek için lütfen klima cihazını monte etmeden önce bu elkitabını dikkatle okuyunuz.

安装手册

为了安全和正确使用本空调器，请在安装前仔细阅读本安装手册。

PŘÍRUČKA K INSTALACI

V zájmu bezpečného a správného používání si před instalací klimatizační jednotky důkladně pročtěte tuto příručku k instalaci.

NÁVOD NA INŠTALÁCIU

Pre bezpečné a správne použitie si pred inštalovaním klimatizačnej jednotky, prosím, starostlivo prečítajte tento návod na inštaláciu.

PRIROČNIK ZA NAMESTITEV

Za varno in pravilno uporabo pred namestitvijo klimatske naprave natančno preberite ta Priročnik za namestitev.

TELEPÍTÉSI KÉZIKÖNYV

A biztonságos és helyes használatához, kérjük, olvassa el alaposan ezt a telepítési kézikönyvet, mielőtt telepítené a légkondicionáló egységet.

PODRĘCZNIK INSTALACJI

W celu bezpiecznego i poprawnego korzystania należy przed zainstalowaniem klimatyzatora dokładnie zapoznać się z niniejszym podręcznikiem instalacji.

GB

D

F

E

I

NL

P

GR

RU

TR

中

CZ

SV

SL

HG

PO

2 **2.1** **2.2**

[Fig. 2.1.1]

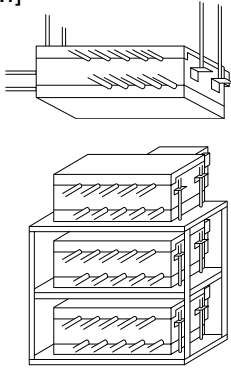

[Fig. 2.2.1]

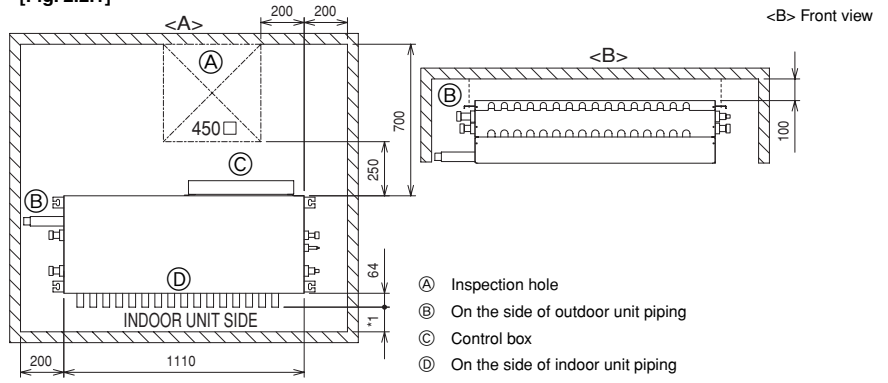

- (A) Inspection hole
 - (B) On the side of outdoor unit piping
 - (C) Control box
 - (D) On the side of indoor unit piping
- *1 Dimensions with which pipe connection can be handled at site

[Fig. 2.2.2]

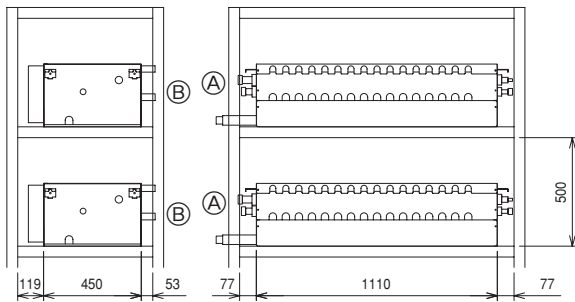

- (A) On the side of outdoor unit piping
- (B) On the side of indoor unit piping

2.3

[Fig. 2.3.1]

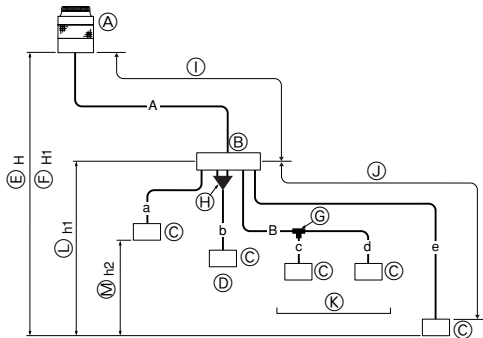

- (A) Outdoor unit
- (B) BC controller
- (C) Indoor unit
- (D) More than 141
- (E) Less than H=50 m (when the outdoor unit is higher than the indoor unit)
- (F) Less than H1=40 m (when the outdoor unit is lower than the indoor unit)
- (G) Branch pipe (for Y Series) CMY-Y102S-G
- (H) Combined pipe (CMY-R160-J: optional)
- (I) Less than 110 m
- (J) Less than 40 m
- (K) Up to three units for 1 branch hole
Total capacity: less than 140 (but same in cooling/heating mode)
- (L) Less than h1=15 m (10 m or less for 125, 140 unit type)
- (M) Less than h2=15 m

(Unit: m)

Item		Piping portion	Allowable value	
Length	Total piping length	A+B+a+b+c+d+e	Below 300*1	
	Longest piping length	A+e	Below 150	
	Between outdoor and BC controllers	A	Below 110	
Difference of elevation	Between indoor and outdoor	e	Below 40*2	
	and outdoor	Above outdoor	H	Below 50
		Below outdoor	H1	Below 40
	Between indoor and BC controllers	h1	Below 15 (Below 10)*3	
	Between indoor and indoor	h2	Below 15 (Below 10)*3	

Notes:

- *1 Please refer to the figure "Allowable Pipe Length" below when the total piping length exceeds 300 m.
- *2 Please refer to the figure "Distance between BC controller and farthest indoor unit" when the distance between BC controller and farthest indoor unit exceeds 40 m.
- *3 10 m or less, with indoor units with model numbers of 125, 140.

Allowable pipe length

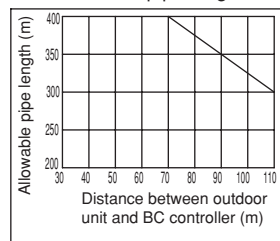

Distance between BC controller and farthest indoor unit

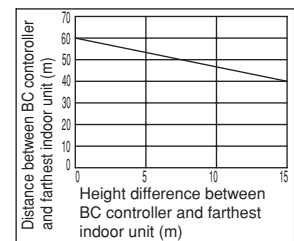

3 **3.2**

[Fig. 3.2.1]

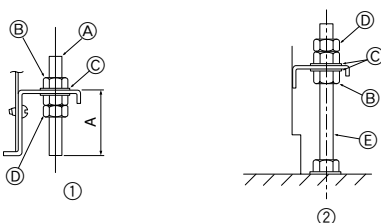

- (1) Hanging method
- (2) Installing-on-the-floor method
- A: Min.30 mm
- (A) Hanging bolt ϕ 10 (field supply)
- (B) Nut (field supply)
- (C) Washer (field supply)
- (D) Double nuts (field supply)
- (E) Anchor bolt M10 (field supply)

[Fig. 4.1.1]

(Unit: mm)

Piping portion		High pressure (liquid) side	Low pressure (gas) side
Item			
Outdoor unit side	PURY-P350	ø19.05 (Brazing)	ø28.58 (Brazing)
	PURY-P400	ø22.2 (Brazing)	
	PURY-P450		
	PURY-P500		
	PURY-P600	ø28.58 (Brazing)	
	PURY-P650		
	Indoor unit side	ø9.52 (Flare)	

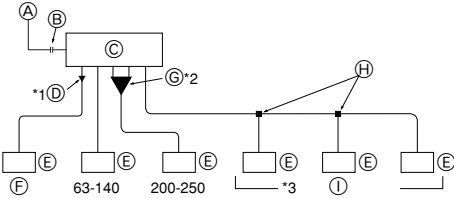

Total capacity of indoor units	Liquid line	Gas line
Below 140	ø9.52	ø15.88
141 to 200		ø19.05
201 to 250		ø22.2

- Ⓐ To outdoor unit
- Ⓑ End connection (brazing)
- Ⓒ BC controller
- Ⓓ Reducer (accessory)
- Ⓔ Indoor unit
- Ⓕ Less than 40
- Ⓖ Combined piping kit (Model name: CMY-R160-J)
- Ⓗ Branch pipe (Model name: CMY-Y102S-G)
- Ⓢ Up to three units for 1 branch hole; total capacity: below 80 (but same in cooling/heating mode)

***1. For connecting 20 to 50 type indoor units**

Connect indoor units using the reducers (specials) supplied with BC controllers.

***2. To connect a unit with a capacity of higher than 141.**

After combining two branches using an optionally available piping kit (CMY-R160-J), connect indoor units.

***3. Connection of plural indoor units with one connection (or joint pipe)**

- Total capacity of connectable indoor units: Less than 140 (Less than 250 with joint pipe)
- Number of connectable indoor units: Maximum 3 Sets
- Branch pipe: Use the branch pipe for CITYMULTIY Series (CMY-Y102S-G)
- Selection of refrigerant piping
Select the size according to the total capacity of indoor units to be installed downstream.

[Fig. 4.1.2]

<A> (high pressure side pipes)

 (low pressure side pipes)

For PURY-P350

For PURY-P400,450,500

For PURY-P550,600,650

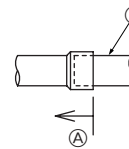
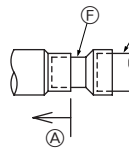
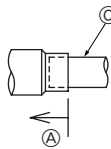
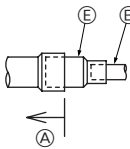

- Ⓐ BC controller
- Ⓑ Locally procured pipe ø19.05
- Ⓒ Locally procured pipe ø22.2
- Ⓓ Locally procured pipe ø28.58
- ⒺⒻ Refrigerant connection pipe (accessory)

4.2

4.3

[Fig. 4.2.1]

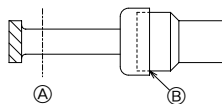

- Ⓐ Cut here
- Ⓑ Remove brazed cap

[Fig. 4.3.1]

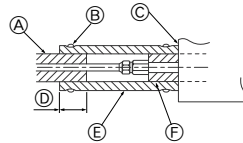

- Ⓐ Locally procured insulating material for pipes
- Ⓑ Bind here using band or tape.
- Ⓒ Do not have any opening.
- Ⓓ Lap margin: more than 40
- Ⓔ Insulating material (field supply)
- Ⓕ Unit side insulating material

4.4

[Fig. 4.4.1]

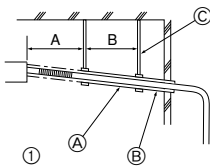

- A: 25 cm B: 1.5 – 2 m
- Ⓐ Downward pitch of more than 1/100
- Ⓑ Insulating material
- Ⓒ Drain discharge port
- Ⓓ Tie band (accessory)

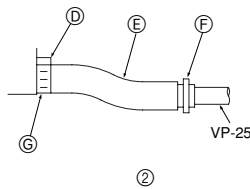

- Ⓒ Supporting bracket
- Ⓓ Drain hose (200 mm long, accessory)
- Ⓔ Hose band (accessory)

[Fig. 4.4.2]

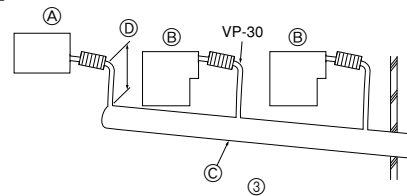

- Ⓐ BC controller
- Ⓑ Indoor unit
- Ⓒ Collecting pipe
- Ⓓ Take as large as possible. About 10 cm.

[Fig. 5.0.1]

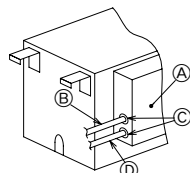

- Ⓐ Control box
- Ⓑ Power source wiring
- Ⓒ ø21 hole (closed rubber bushing)
- Ⓓ Transmission wiring

Contents

1. Safety precautions	4	3. Installing BC controller	6
1.1. Before installation and electric work	4	3.1. Checking the accessories with BC controller	6
1.2. Precautions for devices that use R410A refrigerant	4	3.2. Installing BC controllers	6
1.3. Before getting installed	5	4. Connecting refrigerant pipes and drain pipes	6
1.4. Before getting installed (moved) - electrical work	5	4.1. Connecting refrigerant pipes	6
1.5. Before starting the test run	5	4.2. Refrigerant piping work	7
2. Selecting an installation site	5	4.3. Insulating refrigerant pipes	7
2.1. Installation site	5	4.4. Drain piping work	7
2.2. Securing installation and service space	5	5. Electrical work	8
2.3. Checking the installation site	5	6. Setting addresses and operating units	8
		7. Test run	8

1. Safety precautions

1.1. Before installation and electric work





- ▶ Before installing the unit, make sure you read all the “Safety precautions”.
- ▶ The “Safety precautions” provide very important points regarding safety. Make sure you follow them.
- ▶ Please report to or take consent by the supply authority before connection to the system.

Symbols used in the text

 **Warning:**
Describes precautions that should be observed to prevent danger of injury or death to the user.

 **Caution:**
Describes precautions that should be observed to prevent damage to the unit.

Symbols used in the illustrations

-  : Indicates an action that must be avoided.
-  : Indicates that important instructions must be followed.
-  : Indicates a part which must be grounded.
-  : Beware of electric shock (This symbol is displayed on the main unit label.)
<Color: Yellow>

 **Warning:**
Carefully read the labels affixed to the main unit.

-  **Warning:**
- **Ask the dealer or an authorized technician to install the air conditioner.**
 - Improper installation by the user may result in water leakage, electric shock, or fire.
 - **Install the air unit at a place that can withstand its weight.**
 - Inadequate strength may cause the unit to fall down, resulting in injuries.
 - **Use the specified cables for wiring. Make the connections securely so that the outside force of the cable is not applied to the terminals.**
 - Inadequate connection and fastening may generate heat and cause a fire.
 - **Prepare for earthquakes and install the unit at the specified place.**
 - Improper installation may cause the unit to result in injury.
 - **Always use other accessories specified by Mitsubishi Electric.**
 - Ask an authorized technician to install the accessories. Improper installation by the user may result in water leakage, electric shock, or fire.
 - **Never repair the unit. If the air conditioner must be repaired, consult the dealer.**
 - If the unit is repaired improperly, water leakage, electric shock, or fire may result.
 - **If refrigerant gas leaks during installation work, ventilate the room.**
 - If the refrigerant gas comes into contact with a flame, poisonous gases will be released.
 - **Install the air conditioner according to this Installation Manual.**
 - If the unit is installed improperly, water leakage, electric shock, or fire may result.
 - **Have all electric work done by a licensed electrician according to “Electric Facility Engineering Standard” and “Interior Wire Regulations” and the instructions given in this manual and always use a special circuit.**
 - If the power source capacity is inadequate or electric work is performed improperly, electric shock and fire may result.
 - **Securely install the cover of control box.**
 - If the cover and panel are not installed properly, dust or water may enter the outdoor unit and fire or electric shock may result.
 - **When installing and moving the air conditioner to another site, do not charge it with a refrigerant different from the refrigerant (R410A) specified on the unit.**

- If a different refrigerant or air is mixed with the original refrigerant, the refrigerant cycle may malfunction and the unit may be damaged.
- **If the air conditioner is installed in a small room, measures must be taken to prevent the refrigerant concentration from exceeding the safety limit even if the refrigerant should leak.**
 - Consult the dealer regarding the appropriate measures to prevent the safety limit from being exceeded. Should the refrigerant leak and cause the safety limit to be exceeded, hazards due to lack of oxygen in the room could result.
- **When moving and reinstalling the air conditioner, consult the dealer or an authorized technician.**
 - If the air conditioner is installed improperly, water leakage, electric shock, or fire may result.
- **After completing installation work, make sure that refrigerant gas is not leaking.**
 - If the refrigerant gas leaks and is exposed to a fan heater, stove, oven, or other heat source, it may generate noxious gases.
- **Do not reconstruct or change the settings of the protection devices.**
 - If the pressure switch, thermal switch, or other protection device is shorted and operated forcibly, or parts other than those specified by Mitsubishi Electric are used, fire or explosion may result.

1.2. Precautions for devices that use R410A refrigerant

-  **Caution:**
- **Do not use the existing refrigerant piping.**
 - The old refrigerant and refrigerator oil in the existing piping contains a large amount of chlorine which may cause the refrigerator oil of the new unit to deteriorate.
 - **Use refrigerant piping made of C1220 (Cu-DHP) phosphorus deoxidized copper as specified in the JIS H3300 “Copper and copper alloy seamless pipes and tubes”. In addition, be sure that the inner and outer surfaces of the pipes are clean and free of hazardous sulphur, oxides, dust/dirt, shaving particles, oils, moisture, or any other contaminant.**
 - Contaminants on the inside of the refrigerant piping may cause the refrigerant residual oil to deteriorate.
 - **Store the piping to be used during installation indoors and keep both ends of the piping sealed until just before brazing. (Store elbows and other joints in a plastic bag.)**
 - If dust, dirt, or water enters the refrigerant cycle, deterioration of the oil and compressor trouble may result.
 - **Use ester oil, ether oil or alkylbenzene (small amount) as the refrigerator oil to coat flares and flange connections.**
 - The refrigerator oil will degrade if it is mixed with a large amount of mineral oil.
 - **Use liquid refrigerant to fill the system.**
 - If gas refrigerant is used to seal the system, the composition of the refrigerant in the cylinder will change and performance may drop.
 - **Do not use a refrigerant other than R410A.**
 - If another refrigerant (R22, etc.) is used, the chlorine in the refrigerant may cause the refrigerator oil to deteriorate.
 - **Use a vacuum pump with a reverse flow check valve.**
 - The vacuum pump oil may flow back into the refrigerant cycle and cause the refrigerator oil to deteriorate.
 - **Do not use the following tools that are used with conventional refrigerants. (Gauge manifold, charge hose, gas leak detector, reverse flow check valve, refrigerant charge base, refrigerant recovery equipment)**
 - If the conventional refrigerant and refrigerator oil are mixed in the R410A, the refrigerant may deteriorate.
 - If water is mixed in the R410A, the refrigerator oil may deteriorate.
 - Since R410A does not contain any chlorine, gas leak detectors for conventional refrigerants will not react to it.
 - **Do not use a charging cylinder.**
 - Using a charging cylinder may cause the refrigerant to deteriorate.
 - **Do not use antioxidant or leak-detection additive.**

- **Be especially careful when managing the tools.**
 - If dust, dirt, or water gets in the refrigerant cycle, the refrigerant may deteriorate.

1.3. Before getting installed

⚠ Caution:

- **Do not install the unit where combustible gas may leak.**
 - If the gas leaks and accumulates around the unit, an explosion may result.
- **Do not use the air conditioner where food, pets, plants, precision instruments, or artwork are kept.**
 - The quality of the food, etc. may deteriorate.
- **Do not use the air conditioner in special environments.**
 - Oil, steam, sulfuric smoke, etc. can significantly reduce the performance of the air conditioner or damage its parts.
- **When installing the unit in a hospital, communication station, or similar place, provide sufficient protection against noise.**
 - The inverter equipment, private power generator, high-frequency medical equipment, or radio communication equipment may cause the air conditioner to operate erroneously, or fail to operate. On the other hand, the air conditioner may affect such equipment by creating noise that disturbs medical treatment or image broadcasting.
- **Do not install the unit on a structure that may cause leakage.**
 - When the room humidity exceeds 80 % or when the drain pipe is clogged, condensation may drip from the indoor unit or BC controller. Perform collective drainage work together with the outdoor unit, as required.

1.4. Before getting installed (moved) - electrical work

⚠ Caution:

- **Ground the unit.**
 - Do not connect the ground wire to gas or water pipes, lightning rods, or telephone ground lines. Improper grounding may result in electric shock.
- **Install the power cable so that tension is not applied to the cable.**
 - Tension may cause the cable to break and generate heat and cause a fire.
- **Install a leak circuit breaker, as required.**
 - If a leak circuit breaker is not installed, electric shock may result.
- **Use power line cables of sufficient current carrying capacity and rating.**
 - Cables that are too small may leak, generate heat, and cause a fire.
- **Use only a circuit breaker and fuse of the specified capacity.**
 - A fuse or circuit breaker of a larger capacity, a steel or copper wire may result in a general unit failure or fire.

2. Selecting an installation site

2.1. Installation site

- Place not exposed to rain (BC controller is a special machine for indoor use.)
 - Place with large enough service space
 - Place in which refrigerant pipes can be provided within the limitations
 - Place not exposed to direct radiant heat from other heat sources
 - Do not install the unit in any oily steamy place or near any machine that generates high frequencies. Doing so may cause a risk of fire, erroneous operation or dew drop
 - Place with less noise effect generated from other units
 - Place in which water piping, refrigerant piping and electrical wiring can be done easily
 - Avoid places exposed to the generation, inflow, accumulation or leakage of flammable and sulfuric gases
 - Place in which a downward pitch of more than 1/100 can be taken for drain piping
1. **For hanging from the ceiling [Fig. 2.1.1] (P.2)**
 - Provide a inspection hole 450 mm square to the ceiling surface as shown in [Fig. 2.2.1] (P.2).
 - Above the ceiling of corridor, bath room, etc., where persons are not regularly there (Avoid installing at around center of the room).
 - Place with strength to the degree that hanging bolts can be mounted (that sustains a pull-out load of 60 kg per bolt)
 - Be sure to install BC controllers level.

- **Do not wash the air conditioner units.**
 - Washing them may cause an electric shock.
- **Be careful that the installation base is not damaged by long use.**
 - If the damage is left uncorrected, the unit may fall and cause personal injury or property damage.
- **Install the drain piping according to this Installation Manual to ensure proper drainage. Wrap thermal insulation around the pipes to prevent condensation.**
 - Improper drain piping may cause water leakage causing damage to furniture and other possessions.
- **Be very careful about product transportation.**
 - One person should not carry the product as it weighs more than 20 kg.
 - Some products use PP bands for packaging. Do not use any PP bands as a means of transportation. It is dangerous.
 - Do not touch the heat exchanger fins. Doing so may cut your fingers.
 - When transporting the outdoor unit, support it at the specified positions on the unit base. Also support the outdoor unit at four points so that it cannot slip sideways.
- **Safely dispose of the packing materials.**
 - Packing materials, such as nails and other metal or wooden parts, may cause stabs or other injuries.
 - Tear apart and throw away plastic packaging bags so that children will not play with them. If children play with a plastic bag which was not torn apart, they face the risk of suffocation.

1.5. Before starting the test run

⚠ Caution:

- **Turn on the power at least 12 hours before starting operation.**
 - Starting operation immediately after turning on the main power switch can result irreversible damage to internal parts. Keep the power switch turned on during the operational season.
- **Do not touch the switches with wet fingers.**
 - Touching a switch with wet fingers can cause electric shock.
- **Do not touch the refrigerant pipes during and immediately after operation.**
 - During and immediately after operation, the refrigerant pipes are may be hot and may be cold, depending on the condition of the refrigerant flowing through the refrigerant piping, compressor, and other refrigerant cycle parts. Your hands may suffer burns or frostbite if you touch the refrigerant pipes.
- **Do not operate the air conditioner with the panels and guards removed.**
 - Rotating, hot, or high-voltage parts can cause injuries.
- **Do not turn off the power immediately after stopping operation.**
 - Always wait at least five minutes before turning off the power. Otherwise, water leakage and trouble may occur.

2. For stacking on a rack [Fig. 2.1.1] (P.2)

- Place in which sufficient space can be obtained around a rack
- Place with floor strength that sustains the entire weight

⚠ Warning:

Be sure to install the unit in a place that well sustains the entire weight. If there is a lack of strength, it may cause the unit to fall down, resulting in an injury.

⚠ Caution:

Be sure to install the unit level.

2.2. Securing installation and service space

1. For hanging from the ceiling

(This is a reference view showing the least installation space.)

[Fig. 2.2.1] (P.2)

- | | |
|-------------------|--------------------------------------|
| <A> Top view | Front view |
| Ⓐ Inspection hole | Ⓑ On the side of outdoor unit piping |
| Ⓒ Control box | Ⓓ On the side of indoor unit piping |
- *1 Dimensions with which pipe connection can be handled at site

2. When stacking on a rack

(This is a reference view showing the least installation space.)

[Fig. 2.2.2] (P.2)

- | | |
|--------------------------------------|-------------------------------------|
| Ⓐ On the side of outdoor unit piping | Ⓑ On the side of indoor unit piping |
|--------------------------------------|-------------------------------------|

2.3. Checking the installation site

Check that the difference of elevation between indoor and outdoor units and the length of refrigerant piping are within the following limitations.

[Fig. 2.3.1] (P.2)

- | | |
|----------------|-----------------|
| Ⓐ Outdoor unit | Ⓑ BC controller |
| Ⓒ Indoor unit | Ⓓ More than 141 |

- Ⓔ Less than H=50 m (when the outdoor unit is higher than the indoor unit)
- Ⓕ Less than H1=40 m (when the outdoor unit is lower than the indoor unit)
- Ⓖ Branch pipe (for Y Series) CMY-Y102S-G
- Ⓗ Combined pipe (CMY-R160-J: optional)
- Ⓘ Less than 110 m Ⓚ Less than 40 m
- Ⓚ Up to three units for 1 branch hole
Total capacity: less than 140 (but same in cooling/heating mode)
- Ⓛ Less than h1=15 m (10 m or less for 125, 140 unit type)
- Ⓜ Less than h2=15 m

(Unit: m)

		Item	Piping portion	Allowable value
Length	Total piping length A+B+a+b		Below 300*1 +C+D+e	
	Longest piping length		A+e	Below 150
	Between outdoor unit and BC controller		A	Below 110
	Between indoor units and BC controller		e	Below 40*2
Difference of elevation	Between indoor and outdoor unit	Above outdoor unit	H	Below 50
		Below outdoor unit	H1	Below 40
	Between indoor units and BC controller		h1	Below 15 (Below 10)*3
	Between indoor units		h2	Below 15 (Below 10)*3

Notes:

- *1 Please refer to the figure "Allowable Pipe Length" below when the total piping length exceeds 300 m.
- *2 Please refer to the figure "Distance between BC controller and farthest indoor unit" when the distance between BC controller and farthest indoor unit exceeds 40 m.
- *3 10 m or less, with indoor units with model numbers of 125, 140.

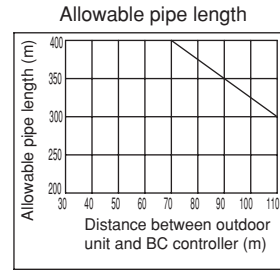

Distance between BC controller and farthest indoor unit

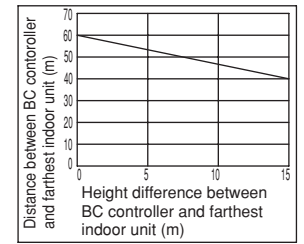

3. Installing BC controller

3.1. Checking the accessories with BC controller

The following items are supplied with each BC controller.

	Item	Qty
①	Drain hose	1
②	Tie band	1
③	Hose band	1
④	Reducer (large & small)	Same number as branch holes
⑤	Refrigerant connection pipe	2

3.2. Installing BC controllers

Installing hanging bolts

Install locally procured hanging bolts (all screws) following the procedure given in the figure. The hanging bolt size is $\phi 10$ (M10 screw).

To hang the unit, use a lifting machine to lift and pass it through the hanging bolts.

[Fig. 3.2.1] (P.2)

- ① Hanging method
- ② Installing-on-the-floor method
- A: Min.30 mm
- Ⓐ Hanging bolt $\phi 10$ (field supply)
- Ⓑ Nut (field supply)
- Ⓒ Washer (field supply)
- Ⓓ Double nuts (field supply)
- Ⓔ Anchor bolt M10 (field supply)

- ▶ Be sure to install the BC controllers level. Installing obliquely may cause a risk of drain leakage. Use a level to check the unit's level. If it is oblique, loosen the fixing nut and make an adjustment.

⚠ Caution:

Be sure to install the unit body level.

4. Connecting refrigerant pipes and drain pipes

4.1. Connecting refrigerant pipes

- Connect the liquid and gas pipes of each indoor unit to the same (correct) end connection numbers as indicated on the indoor unit flare connection section of each BC controller. If connected to wrong end connection numbers, there will be no normal operation.
- List indoor unit model names in the name plate on the BC controller control box (for identification purposes), and BC controller end connection numbers and address numbers in the name plate on the indoor unit side.
- If the number of connected indoor units is less than the number of branch holes, it does not matter which end connections you leave. Seal unused end connections using flare nuts with end caps just as they were capped when shipped from the factory. No end cap will lead to refrigerant leakage.
- When using branch pipes (CMY-Y102S-G), be sure to connect them level.
- Be sure to tighten the flare nuts using a double spanner. Otherwise the refrigerant may leak.
- Be sure to use non-oxidative brazing where necessary. If you do not use non-oxidative brazing, it may clog the pipes.
- After completing pipe connection, support the pipes to ensure that load is not imparted to the BC controller's end connections (particularly to the gas pipes of indoor units).

⚠ Warning:

When installing and moving the unit, do not charge it with refrigerant other than the refrigerant (R410A) specified on the unit.

- Mixing of a different refrigerant, air, etc. may cause the refrigerant cycle to malfunction and result in severe damage.

⚠ Caution:

- Use refrigerant piping made of C1220 (Cu-DHP) phosphorus deoxidized copper as specified in the JIS H3300 "Copper and copper alloy seamless pipes and tubes". In addition, be sure that the inner and outer surfaces of the pipes are clean and free of hazardous sulphur, oxides, dust/dirt, shaving particles, oils, moisture, or any other contaminant.
- Never use existing refrigerant piping.
 - The large amount of chlorine in conventional refrigerant and refrigerant oil in the existing piping will cause the new refrigerant to deteriorate.
- Store the piping to be used during installation indoors and keep both ends of the piping sealed until just before brazing.
 - If dust, dirt, or water gets into the refrigerant cycle, the oil will deteriorate and the compressor may fail.
- Use ester oil, ether oil or alkylbenzene (small amount) as the refrigerant oil to coat flares and flange connections.
 - The refrigerant used in the unit is highly hygroscopic and if it mixes with water it will degrade the refrigerant oil.

1. Size of BC controller's end connection piping

[Fig. 4.1.1] (P.3)

(Unit: mm)

Item	Piping portion	
	High pressure (liquid) side	Low pressure (gas) side
Outdoor unit side	PURY-P350	ø19.05 (Brazing)
	PURY-P400	
	PURY-P450	ø22.2 (Brazing)
	PURY-P500	
	PURY-P550	ø28.58 (Brazing)
	PURY-P600	
PURY-P650		
Indoor unit side	ø9.52 (Flare)	ø15.88 (Flare)

- Ⓐ To outdoor unit
- Ⓑ BC controller
- Ⓒ Indoor unit
- Ⓓ Combined piping kit (Model name: CMY-R160-J)
- Ⓔ Branch pipe (Model name: CMY-Y102S-G)
- ① Up to three units for 1 branch hole; total capacity: below 80 (but same in cooling/heating mode)
- Ⓔ End connection (brazing)
- Ⓕ Reducer (accessory)
- Ⓖ Less than 40

The size of BC controller's branch piping is for 50 to 63 type indoor units. Therefore, if you want to connect indoor units other than the above, do pipe connection following the procedure below.

*1. For connecting 20 to 40 type indoor units

Connect indoor units using the reducers (specials) supplied with BC controllers.

Note:

The flare nuts supplied with BC controllers should be used together.

*2. To connect a unit with a capacity of higher than 141.

After combining two branches using an optionally available piping kit (CMY-R160-J), connect indoor units.

*3. Connection of plural indoor units with one connection (or joint pipe)

- Total capacity of connectable indoor units: Less than 140 (Less than 250 with joint pipe)
- Number of connectable indoor units: Maximum 3 Sets
- Branch pipe: Use the branch pipe for CITYMULTI Y Series (CMY-Y102S-G)
- Selection of refrigerant piping ([Fig. 4.1.2] (P.3))
Select the size according to the total capacity of indoor units to be installed downstream.

Total capacity of indoor units	Liquid line	Gas line
Below 140	ø9.52	ø15.88
141 to 200		ø19.05
201 to 250		ø22.2

2. Connecting to out side pipes

- For PURY-P350, 400, 450, 500, 550, 600, 650

[Fig. 4.1.2] (P.3)

- <A> (high pressure side pipes)
- (low pressure side pipes)
- Ⓐ BC controller
- Ⓑ Locally procured pipe ø19.05
- Ⓒ Locally procured pipe ø22.2
- Ⓓ Locally procured pipe ø28.58
- Ⓔ Refrigerant connection pipe (accessory)

Note:

- Be sure to use non-oxidative brazing.

4.2. Refrigerant piping work

After connecting the refrigerant pipes of all indoor and outdoor units with the outdoor units' stop valves remained fully closed, evacuate vacuum from the outdoor units' stop valve service ports.

After completing the above, open the outdoor units' stop valves. This connects the refrigerant circuit (between outdoor and BC controller) completely. How to handle stop valves is described on each outdoor unit.

Notes:

- Before tightening the flare nut, apply refrigerating machine oil lightly over the valve flare surface and its seating surface.
- Use a double spanner for pipe connection.
- After pipe connection, be sure to check that there is no gas leakage, using a leak detector or soap-and-water solution.
- Before brazing the refrigerant piping, always wrap the piping on the main body, and the thermal insulation piping, with damp cloths to prevent heat shrinkage and burning the thermal insulation tubing. Take care to ensure that the flame does not come into contact with the main body itself.
- Do not use leak-detection additive.

⚠ Warning:

Do not mix anything other than the specified refrigerant (R410A) into the refrigerating cycle when installing or moving. Mixing air may cause the refrigerating cycle to get abnormally high temperature, resulting in a burst.

⚠ Caution:

Cut the tip of the indoor unit piping, remove the gas, and then remove the brazed cap.

[Fig. 4.2.1] (P.3)

- Ⓐ Cut here
- Ⓑ Remove brazed cap

4.3. Insulating refrigerant pipes

Be sure to wind heat-resisting polyethylene form of more than 20 mm in thickness onto both liquid and gas pipes and also put it into the joints between indoor unit and insulating material so that there will be no gap. Incomplete insulation may cause a risk of dew drop. Pay careful attention, particularly when insulating above the ceiling.

[Fig. 4.3.1] (P.3)

- Ⓐ Locally procured insulating material for pipes
- Ⓑ Bind here using band or tape.
- Ⓒ Do not have any opening.
- Ⓓ Lap margin: more than 40
- Ⓔ Insulating material (field supply)
- Ⓕ Unit side insulating material

4.4. Drain piping work

1. Drain piping work

- Ensure that the drain piping is downward (pitch of more than 1/100) to the outdoor (discharge) side. If it is impossible to take any downward pitch, use an optionally available drain-up mechanism to obtain a downward pitch of more than 1/100.
- Ensure that any cross-wise drain piping is less than 20 m. If the drain piping is long, provide metal braces to prevent it from waving. Never provide any air vent pipe. Otherwise drain may be ejected.
- Connect the supplied drain hose to the discharge port on the unit body. Use hard vinyl chloride pipes VP-25 (ø32) for drain piping (Ⓓ). Tighten the supplied drain hose onto the discharge port using the supplied hose band. (For this, do not use any adhesive because the drain hose will be removed for service later.)
- Do not have any odor trap around the discharge port.

[Fig. 4.4.1] (P.3)

- A: 25 cm
- B: 1.5 – 2 m
- Ⓐ Downward pitch of more than 1/100
- Ⓑ Insulating material
- Ⓒ Supporting bracket
- Ⓓ Drain discharge port
- Ⓔ Drain hose (200 mm long, accessory)
- Ⓕ Tie band (accessory)
- Ⓖ Hose band (accessory)

- As shown in Ⓒ, install a collecting pipe about 10 cm below the drain ports and give it a downward pitch of more than 1/100. This collecting pipe should be of VP-30.

- Set the end of drain piping in a place without any risk of odor generation.
- Do not put the end of drain piping into any drain where ionic gases are generated.
- Although it is free to choose to take out piping in any direction, be sure to observe the instructions above.
- When using an optionally available drain-up mechanism, follow its instruction manual for drain piping.

[Fig. 4.4.2] (P.3)

- Ⓐ BC controller
- Ⓑ Indoor unit
- Ⓒ Collecting pipe
- Ⓓ Take as large as possible. About 10 cm.

2. Discharge test

After completing drain piping work, open the BC controller panel, fill water, and test drain discharge. At this moment, check to see that there is no water leakage from the connections.

3. Insulating drain pipes

Provide sufficient insulation onto the drain pipes just as for refrigerant pipes.

⚠ Caution:

Be sure to provide drain piping and heat-insulate it in order to prevent dew condensation. If there is a deficiency in piping work, it may cause a risk of water leakage and so wet your property.

5. Electrical work

- ▶ Consult all related regulations and power companies beforehand.

Warning:

Electrical work should be handled by qualified electric engineers in accordance with all related regulations and attached instruction manuals. Special circuits should also be used. If there is a lack of power capacity or a deficiency in electrical work, it may cause a risk of electric shock or fire.

- ▶ Connect all wires without looseness.

- Fix power source wiring to control box by using buffer bushing for tensile force (PG connection or the like).

[Fig. 5.0.1] (P.3)

- Ⓐ Control box
- Ⓑ Power source wiring
- Ⓒ ø21 hole (closed rubber bushing)
- Ⓓ Transmission wiring

- ▶ Never connect the power cable to the terminal board for control cables. (Otherwise it may be broken.)
- ▶ Be sure to wire between the control wire terminal boards for indoor unit, outdoor unit and BC controller.

Transmission cables are of crossover wiring method by non-polarized 2-wires. Use 2-core shielding cables (CVVS, CPEVS) of more than 1.25 mm² in diameter for transmission cables.

The switch capacity of the main power to BC controllers and the wire size are as follows:

Switch (A)		Molded case circuit breaker	Earth leakage breaker	Wire size
Capacity	Fuse			
15	15	20 A	20 A 30 mA 0.1 s or less	1.5 mm ²

- For other detailed information, refer to the outdoor unit installation manual.
- Power supply cords of appliances shall not be lighter than design 245 IEC 53 or 227 IEC 53.
- A switch with at least 3 mm contact separation in each pole shall be provided by the Air conditioner installation.

Caution:

Do not use anything other than the correct capacity fuse and breaker. Using fuse, conductor or copper wire with too large capacity may cause a risk of malfunction or fire.

Ensure that the outdoor units are put to the ground. Do not connect the earth cable to any gas pipe, water pipe, lightning rod or telephone earth cable. Incomplete grounding may cause a risk of electric shock.

6. Setting addresses and operating units

The address switch of each BC controller is set to "000" when shipped from the factory. Check it.

- Set the address switch to 1 + the address of the outdoor unit.
- ▶ The BC controller address should generally be set to 1 + the address of the outdoor unit. However, if this would result in it having the same address as another outdoor unit, set the address between 51 and 100, making sure that it is different from the address of other controllers.
- Please refer to the outdoor unit installation manual.

7. Test run

Before getting test run checked

- ▶ After installing, piping and wiring the indoor units and BC controllers, check to see again that there is no refrigerant leakage or no slack on power and control cables.
- ▶ Use a 500 V megger to check that there is an insulation resistance of more than 1.0 MΩ between the power terminal bed and the ground. If it is less than 1.0 MΩ, do not get operated.

Caution:

Never measure the insulation resistance of the terminal bed for control cables.

This product is designed and intended for use in the residential, commercial and light-industrial environment.

The product at hand is based on the following EU regulations:

- Low Voltage Directive 73/23/EEC
- Electromagnetic Compatibility Directive 89/336/EEC

Please be sure to put the contact address/telephone number on this manual before handing it to the customer.