



CMB-P108V-GA

Master BC Controller

R410A



At the heart of both the R2 and WR2 Series, the BC Controller makes simultaneous heating and cooling possible. It has the inherent 'intelligence' to be the system's decision-maker.

- **Transfers energy around the system, drawing on energy from the heat source units/outdoor units**
- **Directing energy as requested by the individual indoor units**
- **Instructs the heat source unit/outdoor unit on the amount of refrigerant (liquid or gas) that is required to achieve the requested cooling or heating requirements**
- **Allows unique 2-pipe heat recovery**
- **HIC Circuit for improved efficiency**

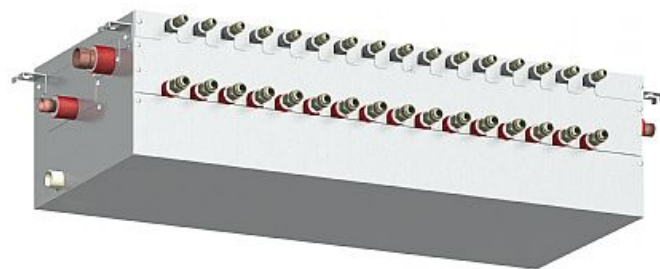

Pictures not to scale

Product Details

CMB-P108V-GA	
Number of Connections	8
Power Input (kW) (Nominal)	0.161
Width - mm	1110
Depth - mm	450 + 70
Height - mm	289
Weight - kg	44
Electrical Supply	220-240v, 50Hz
Phase	Single
Mains Cable No. Cores	3
Running Current (A)	0.68
Fuse Rating (BS88) - HRC (A)	6

Dimensions

CMB-P108V-GA

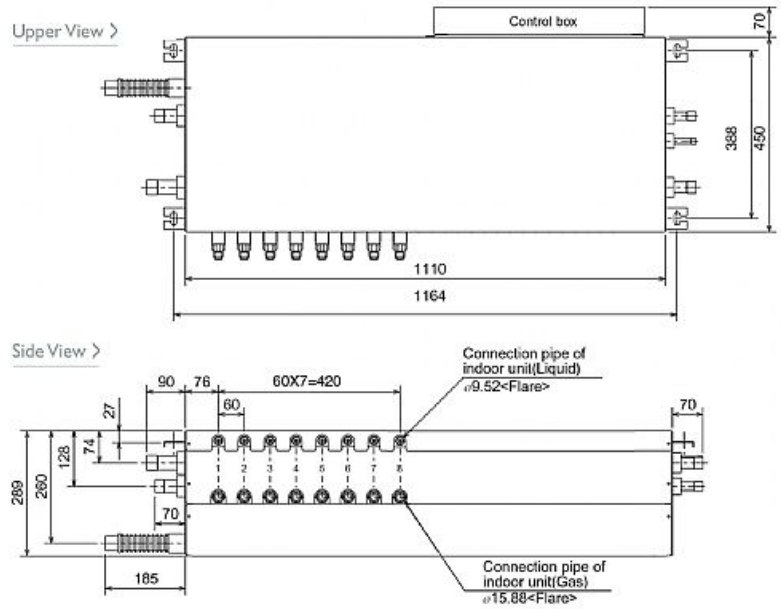

Telephone: 01707 282880

Email: air.conditioning@meuk.mee.com Website: <http://www.mitsubishielectric.co.uk/aircon>

Mitsubishi Electric reserves the right to make any variation in technical specification to the equipment described, or to withdraw or replace products without prior notification or public announcement.

Tel:
Fax:

