

# Air-Conditioners INDOOR UNIT



# PEFY-P-VMS-E

## INSTALLATION MANUAL

For safe and correct use, please read this installation manual thoroughly before installing the air-conditioner unit.

## INSTALLATIONSHANDBUCH

Zum sicheren und ordnungsgemäßen Gebrauch der Klimageräte das Installationshandbuch gründlich durchlesen.

## MANUEL D'INSTALLATION

Veuillez lire le manuel d'installation en entier avant d'installer ce climatiseur pour éviter tout accident et vous assurer d'une utilisation correcte.

## MANUAL DE INSTALACIÓN

Para un uso seguro y correcto, lea detalladamente este manual de instalación antes de montar la unidad de aire acondicionado.

## MANUALE DI INSTALLAZIONE

Per un uso sicuro e corretto, leggere attentamente questo manuale di installazione prima di installare il condizionatore d'aria.

## INSTALLATIEHANDLEIDING

Voor een veilig en juist gebruik moet u deze installatiehandleiding grondig doorlezen voordat u de airconditioner installeert.

## MANUAL DE INSTALAÇÃO

Para segurança e utilização correctas, leia atentamente este manual de instalação antes de instalar a unidade de ar condicionado.

## ΕΓΧΕΙΡΙΔΙΟ ΟΔΗΓΙΩΝ ΕΓΚΑΤΑΣΤΑΣΗΣ

Για ασφάλεια και σωστή χρήση, παρακαλείστε διαβάσετε προσεχτικά αυτό το εγχειρίδιο εγκατάστασης πριν αρχίσετε την εγκατάσταση της μονάδας κλιματισμού.

## РУКОВОДСТВО ПО УСТАНОВКЕ

Для осторожного и правильного использования прибора необходимо тщательно ознакомиться с данным руководством по установке до выполнения установки кондиционера.

## MONTAJ ELKİTABI

Emniyetli ve doğru biçimde nasıl kullanılacağını öğrenmek için lütfen klima cihazını monte etmeden önce bu elkitabını dikkatle okuyunuz.

## 安装手册

为了安全和正确地使用本空调器，请在安装前仔细阅读本安装手册。

## PŘÍRUČKA K INSTALACI

V zájmu bezpečného a správného používání si před instalací klimatizační jednotky důkladně pročtěte tuto příručku k instalaci.

## NÁVOD NA INŠTALÁCIU

Pre bezpečné a správne použitie si pred inštalovaním klimatizačnej jednotky, prosím, starostlivo prečítajte tento návod na inštaláciu.

## TELEPÍTÉSI KÉZIKÖNYV

A biztonságos és helyes használatához, kérjük, olvassa el alaposan ezt a telepítési kézikönyvet, mielőtt telepítené a légkondicionáló egységet.

## PODRĘCZNIK INSTALACJI

W celu bezpiecznego i poprawnego korzystania należy przed zainstalowaniem klimatyzatora dokładnie zapoznać się z niniejszym podręcznikiem instalacji.

## PRIROČNIK ZA NAMESTITEV

Za varno in pravilno uporabo pred namestitvijo klimatske naprave skrbno preberite priročnik za namestitev.

GB

D

F

E

I

NL

P

GR

RU

TR

#

CZ

SV

HG

PO

SL

[Fig. 3.2.1]

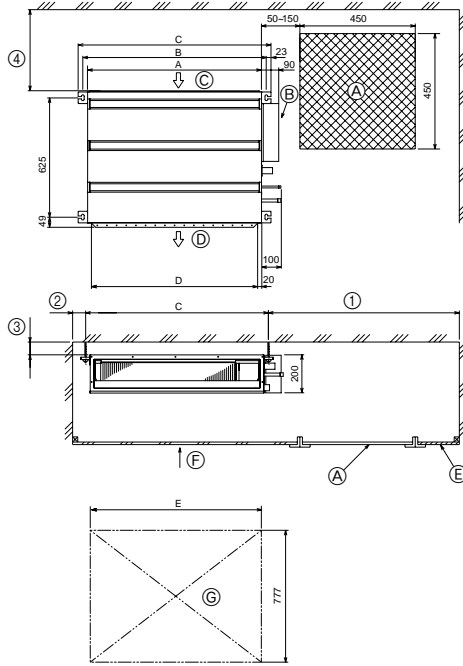

- Ⓐ Access door
- Ⓑ Electrical parts box
- Ⓒ Air inlet
- Ⓓ Air outlet
- Ⓔ Ceiling surface
- Ⓕ Service space (viewed from the side)
- Ⓖ Service space (viewed from the direction of arrow)
- ① 600 mm or more
- ② 100 mm or more
- ③ 20 mm or more
- ④ 300 mm or more

Model	A	B	C	D	E
PEFY-P20,25,32,40VMS-E	900	952	998	860	1000
PEFY-P50VMS-E	1100	1152	1198	1060	1200

(mm)

[Fig. 4.1.1]

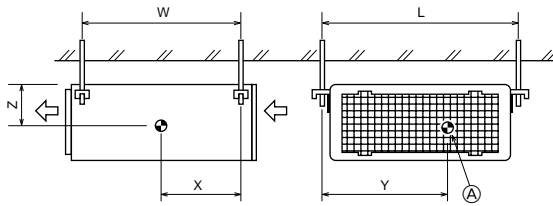

- Ⓐ Center of gravity

[Fig. 5.1.1]

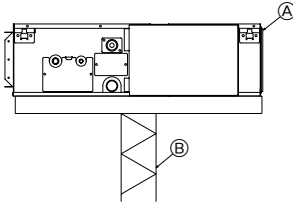

- Ⓐ Unit body
- Ⓑ Lifting machine

[Fig. 5.1.2]

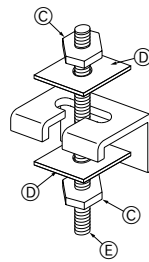

- Ⓒ Nuts (field supply)
- Ⓓ Washers (field supply)
- Ⓔ M10 hanging bolt (field supply)

[Fig. 5.2.1]

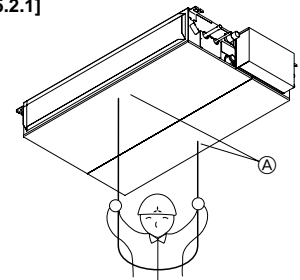

- Ⓐ Indoor unit's bottom surface

[Fig. 6.2.1]

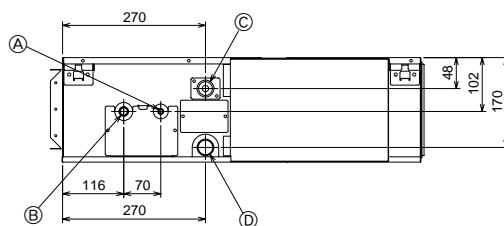

- Ⓐ Refrigerant pipe (liquid pipe): HP
- Ⓑ Refrigerant pipe (gas pipe): LP
- Ⓒ Drain pipe (O.D. ø32)
- Ⓓ Drain pipe (O.D. ø32, spontaneous draining)

[Fig. 7.1.1]

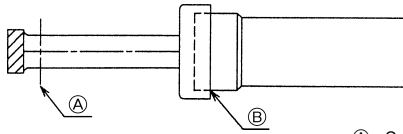

- A Cut here
- B Remove brazed cap

[Fig. 7.1.2]

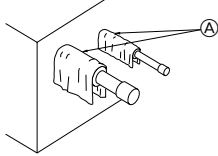

- A Cool by a wet cloth

[Fig. 7.1.3]

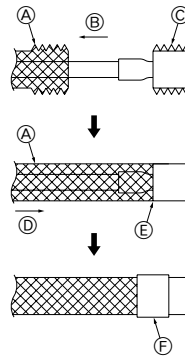

- A Thermal insulation
- B Pull out insulation
- C Wrap with damp cloth
- D Return to original position
- E Ensure that there is no gap here
- F Wrap with insulating tape

7.2

[Fig. 7.2.1]

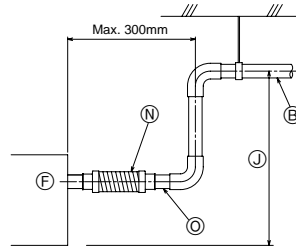
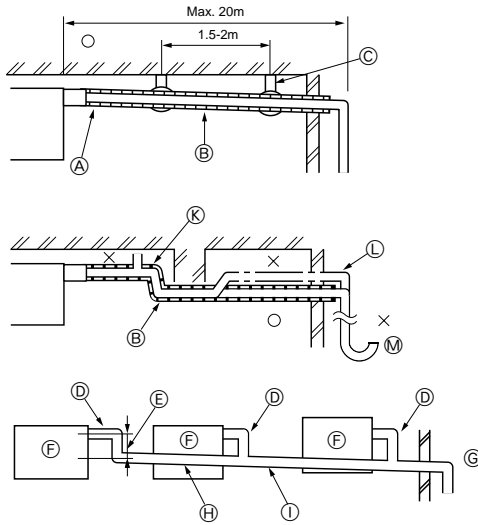

- Correct piping
  - × Wrong piping
  - A Insulation (9 mm or more)
  - B Downward slope (1/100 or more)
  - C Support metal
  - K Air bleeder
  - L Raised
  - M Odor trap
- Grouped piping**
- D O. D. ø32 PVC TUBE
  - E Make it as large as possible. About 10 cm.
  - F Indoor unit
  - G Make the piping size large for grouped piping.
  - H Downward slope (1/100 or more)
  - I O. D. ø38 PVC TUBE for grouped piping. (9 mm or more insulation)
  - J Up to 550 mm
  - N Drain hose (accessory)
  - O Horizontal or slightly upgradient

[Fig. 7.2.2]

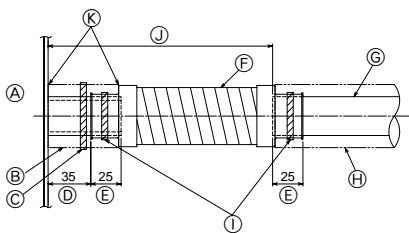

- A Indoor unit
- B Insulation pipe (accessory)
- C Tie band (accessory)
- D Visible part
- E Insertion margin
- F Drain hose (accessory)
- G Drain pipe (O.D. ø32 PVC TUBE, field supply)
- H Insulating material (field supply)
- I Tie band (accessory)
- J Max.180 ± 5mm
- K To be gap free. The joint section of the insulation material meet must be at the top.

## 7.3

[Fig. 7.3.1]

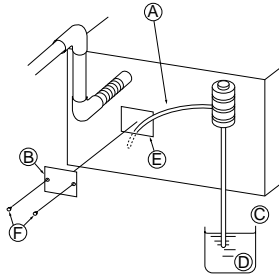

- (A) Insert pump's end 2 to 4 cm.
- (B) Remove the water supply port.
- (C) About 2000 cc
- (D) Water
- (E) Filling port
- (F) Screw

[Fig. 7.3.2]

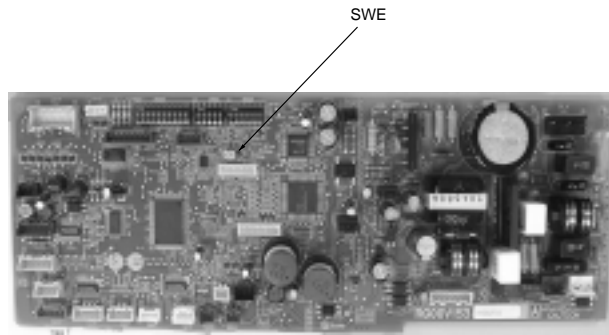

<Indoor board>

## 8

[Fig. 8.0.1]

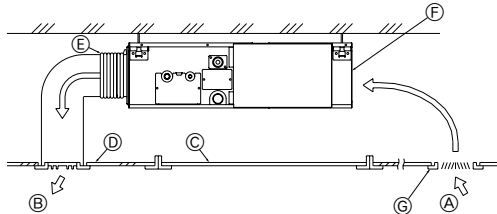

- (A) Air inlet
- (B) Air outlet
- (C) Access door
- (D) Ceiling surface
- (E) Canvas duct
- (F) Air filter
- (G) Inlet grille

## 9

### 9.1

[Fig. 9.1.1]

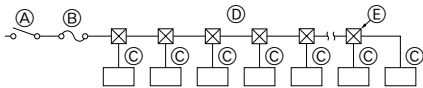

- (A) Switch 16 A
- (B) Overcurrent protection 16 A
- (C) Indoor unit
- (D) Total operating current be less than 16 A
- (E) Pull box

### 9.2

[Fig. 9.2.1]

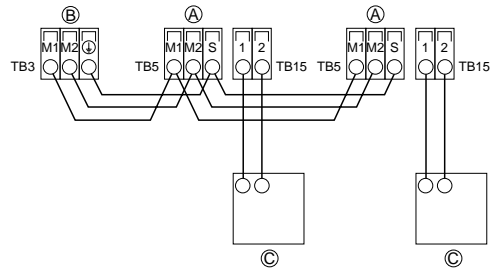

[Fig. 9.2.2]

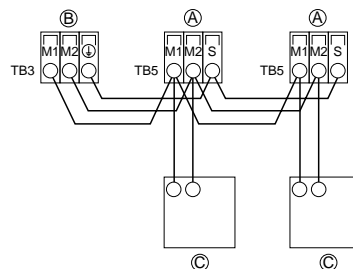

- (A) Terminal block for indoor transmission cable
- (B) Terminal block for outdoor transmission cable
- (C) Remote controller

[Fig. 9.2.3]

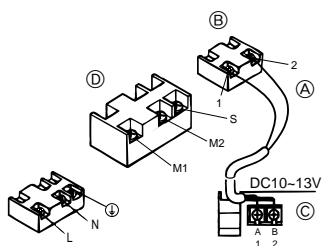

[Fig. 9.2.4]

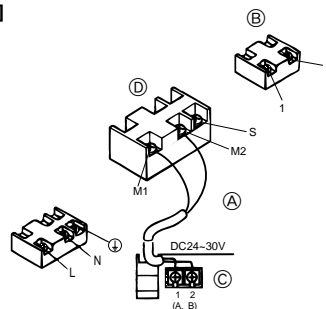

- (A) Non-polarized
- (B) TB15
- (C) Remote Controller
- (D) TB5

## 9.3

[Fig. 9.3.1]

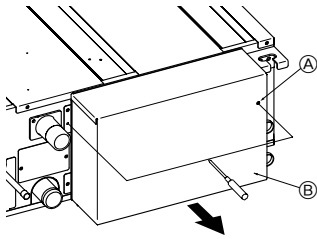

- A Screw holding cover (2pcs)
- B Cover

[Fig. 9.3.2]

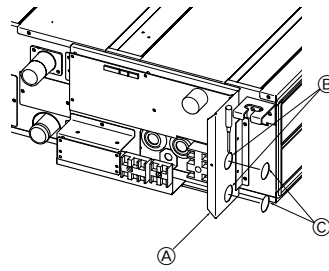

- A Terminal bed box
- B Knockout hole
- C Remove

[Fig. 9.3.3]

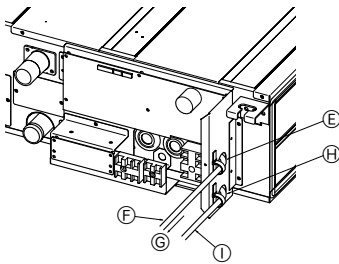

- E Use PG bushing to keep the weight of the cable and external force from being applied to the power supply terminal connector. Use a cable tie to secure the cable.
- F Power source wiring
- G Tensile force
- H Use ordinary bushing
- I Transmission wiring

[Fig. 9.3.4]

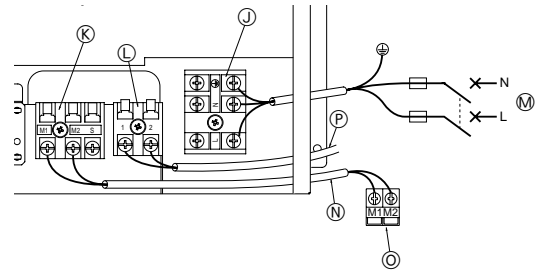

- J Power source terminal bed
- K Terminal bed for indoor transmission
- L Terminal bed for remote controller
- M To 1-phase power source
- N Transmission line DC 30 V
- O Terminal bed for outdoor transmission line (TB3)
- P Transmission line to the remote controller, terminal bed for indoor unit and BC controller

[Fig. 9.3.5]

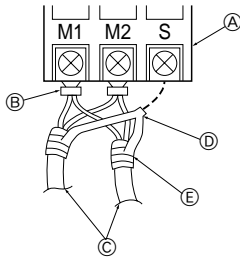

- A Terminal bed
- B Round terminal
- C Shield wire
- D The earth wire from two cables are connected together to the S terminal. (Dead-end connection)
- E Insulation tape (To keep the earth wire of the shielded cable from coming in contact with the transmission terminal)

## 9.5

[Fig. 9.5.1]

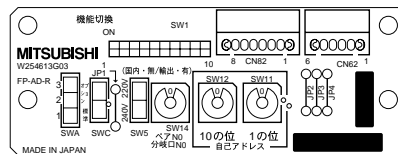

<Address board>

1. Safety precautions .....	6	6. Refrigerant pipe and drain pipe specifications .....	8
1.1. Before installation and electric work .....	6	6.1. Refrigerant pipe and drain pipe specifications .....	9
1.2. Precautions for devices that use R410A or R407C refrigerant .....	6	6.2. Refrigerant pipe, drain pipe .....	9
1.3. Before getting installed .....	7	7. Connecting refrigerant pipes and drain pipes .....	9
1.4. Before getting installed (moved) - electrical work .....	7	7.1. Refrigerant piping work .....	9
1.5. Before starting the test run .....	7	7.2. Drain piping work .....	9
2. Indoor unit accessories .....	7	7.3. Confirming drain discharge .....	10
3. Selecting an installation site .....	7	8. Duct work .....	10
3.1. Install the indoor unit on a ceiling strong enough to sustain its weight .....	8	9. Electrical wiring .....	10
3.2. Securing installation and service space .....	8	9.1. Power supply wiring .....	11
3.3. Combining indoor units with outdoor units .....	8	9.2. Connecting remote controller, indoor and outdoor transmission cables .....	11
4. Fixing hanging bolts .....	8	9.3. Connecting electrical connections .....	11
4.1. Fixing hanging bolts .....	8	9.4. External I/O specifications .....	11
5. Installing the unit .....	8	9.5. Selecting the external static pressure .....	12
5.1. Hanging the unit body .....	8	9.6. Setting addresses .....	12
5.2. Confirming the unit's position and fixing hanging bolts .....	8	9.7. Sensing room temperature with the built-in sensor in a remote controller .....	12

## 1. Safety precautions

### 1.1. Before installation and electric work





- ▶ **Before installing the unit, make sure you read all the “Safety precautions”.**
- ▶ **The “Safety precautions” provide very important points regarding safety. Make sure you follow them.**

#### Symbols used in the text

 **Warning:**  
Describes precautions that should be observed to prevent danger of injury or death to the user.

 **Caution:**  
Describes precautions that should be observed to prevent damage to the unit.

#### Symbols used in the illustrations

-  : Indicates an action that must be avoided.
-  : Indicates that important instructions must be followed.
-  : Indicates a part which must be grounded.
-  : Indicates that caution should be taken with rotating parts. (This symbol is displayed on the main unit label.) <Color: Yellow>
-  : Beware of electric shock (This symbol is displayed on the main unit label.) <Color: Yellow>

-  **Warning:**  
**Carefully read the labels affixed to the main unit.**

-  **Warning:**
  - **Ask the dealer or an authorized technician to install the air conditioner.**
    - Improper installation by the user may result in water leakage, electric shock, or fire.
  - **Install the air unit at a place that can withstand its weight.**
    - Inadequate strength may cause the unit to fall down, resulting in injuries.
  - **Use the specified cables for wiring. Make the connections securely so that the outside force of the cable is not applied to the terminals.**
    - Inadequate connection and fastening may generate heat and cause a fire.
  - **Prepare for typhoons and other strong winds and earthquakes and install the unit at the specified place.**
    - Improper installation may cause the unit to topple and result in injury.
  - **Always use an air cleaner, humidifier, electric heater, and other accessories specified by Mitsubishi Electric.**
    - Ask an authorized technician to install the accessories. Improper installation by the user may result in water leakage, electric shock, or fire.
  - **Never repair the unit. If the air conditioner must be repaired, consult the dealer.**
    - If the unit is repaired improperly, water leakage, electric shock, or fire may result.
  - **Do not touch the heat exchanger fins.**
    - Improper handling may result in injury.
  - **When handling this product, always wear protective equipment.**  
**EG: Gloves, full arm protection namely boiler suit, and safety glasses.**
    - Improper handling may result in injury.
  - **If refrigerant gas leaks during installation work, ventilate the room.**
    - If the refrigerant gas comes into contact with a flame, poisonous gases will be released.

- **Install the air conditioner according to this Installation Manual.**
  - If the unit is installed improperly, water leakage, electric shock, or fire may result.
- **Have all electric work done by a licensed electrician according to “Electric Facility Engineering Standard” and “Interior Wire Regulations” and the instructions given in this manual and always use a special circuit.**
  - If the power source capacity is inadequate or electric work is performed improperly, electric shock and fire may result.
- **Keep the electric parts away from water (washing water etc.).**
  - It might result in electric shock, catching fire or smoke.
- **Securely install the outdoor unit terminal cover (panel).**
  - If the terminal cover (panel) is not installed properly, dust or water may enter the outdoor unit and fire or electric shock may result.
- **When installing and moving the air conditioner to another site, do not charge the it with a refrigerant different from the refrigerant specified on the unit.**
  - If a different refrigerant or air is mixed with the original refrigerant, the refrigerant cycle may malfunction and the unit may be damaged.
- **If the air conditioner is installed in a small room, measures must be taken to prevent the refrigerant concentration from exceeding the safety limit even if the refrigerant should leak.**
  - Consult the dealer regarding the appropriate measures to prevent the safety limit from being exceeded. Should the refrigerant leak and cause the safety limit to be exceeded, hazards due to lack of oxygen in the room could result.
- **When moving and reinstalling the air conditioner, consult the dealer or an authorized technician.**
  - If the air conditioner is installed improperly, water leakage, electric shock, or fire may result.
- **After completing installation work, make sure that refrigerant gas is not leaking.**
  - If the refrigerant gas leaks and is exposed to a fan heater, stove, oven, or other heat source, it may generate noxious gases.
- **Do not reconstruct or change the settings of the protection devices.**
  - If the pressure switch, thermal switch, or other protection device is shorted and operated forcibly, or parts other than those specified by Mitsubishi Electric are used, fire or explosion may result.
- **To dispose of this product, consult your dealer.**
- **Do not use a leak detection additive.**

### 1.2. Precautions for devices that use R410A or R407C refrigerant

-  **Caution:**
  - **Do not use the existing refrigerant piping.**
    - The old refrigerant and refrigerator oil in the existing piping contains a large amount of chlorine which may cause the refrigerator oil of the new unit to deteriorate.
  - **Use refrigerant piping made of C1220 (Cu-DHP) phosphorus deoxidized copper as specified in the JIS H3300 “Copper and copper alloy seamless pipes and tubes”. In addition, be sure that the inner and outer surfaces of the pipes are clean and free of hazardous sulphur, oxides, dust/dirt, shaving particles, oils, moisture, or any other contaminant.**
    - Contaminants on the inside of the refrigerant piping may cause the refrigerant residual oil to deteriorate.
  - **Store the piping to be used during installation indoors and keep both ends of the piping sealed until just before brazing. (Store elbows and other joints in a plastic bag.)**
    - If dust, dirt, or water enters the refrigerant cycle, deterioration of the oil and compressor trouble may result.

- **Use ester oil, ether oil or alkylbenzene (small amount) as the refrigerant oil to coat flares and flange connections.**
  - The refrigerant oil will degrade if it is mixed with a large amount of mineral oil.
- **Use liquid refrigerant to fill the system.**
  - If gas refrigerant is used to seal the system, the composition of the refrigerant in the cylinder will change and performance may drop.
- **Do not use a refrigerant other than R410A or R407C.**
  - If another refrigerant (R22, etc.) is used, the chlorine in the refrigerant may cause the refrigerant oil to deteriorate.
- **Use a vacuum pump with a reverse flow check valve.**
  - The vacuum pump oil may flow back into the refrigerant cycle and cause the refrigerant oil to deteriorate.
- **Do not use the following tools that are used with conventional refrigerants.**

**(Gauge manifold, charge hose, gas leak detector, reverse flow check valve, refrigerant charge base, vacuum gauge, refrigerant recovery equipment)**

  - If the conventional refrigerant and refrigerant oil are mixed in the R410A or R407C, the refrigerant may deteriorate.
  - If water is mixed in the R410A or R407C, the refrigerant oil may deteriorate.
  - Since R410A or R407C does not contain any chlorine, gas leak detectors for conventional refrigerants will not react to it.
- **Do not use a charging cylinder.**
  - Using a charging cylinder may cause the refrigerant to deteriorate.
- **Be especially careful when managing the tools.**
  - If dust, dirt, or water gets in the refrigerant cycle, the refrigerant may deteriorate.

### 1.3. Before getting installed

#### ⚠ Caution:

- **Do not install the unit where combustible gas may leak.**
  - If the gas leaks and accumulates around the unit, an explosion may result.
- **Do not use the air conditioner where food, pets, plants, precision instruments, or artwork are kept.**
  - The quality of the food, etc. may deteriorate.
- **Do not use the air conditioner in special environments.**
  - Oil, steam, sulfuric smoke, etc. can significantly reduce the performance of the air conditioner or damage its parts.
- **When installing the unit in a hospital, communication station, or similar place, provide sufficient protection against noise.**
  - The inverter equipment, private power generator, high-frequency medical equipment, or radio communication equipment may cause the air conditioner to operate erroneously, or fail to operate. On the other hand, the air conditioner may affect such equipment by creating noise that disturbs medical treatment or image broadcasting.
- **Do not install the unit on a structure that may cause leakage.**
  - When the room humidity exceeds 80% or when the drain pipe is clogged, condensation may drip from the indoor unit. Perform collective drainage work together with the outdoor unit, as required.
- **The indoor models should be installed the ceiling over than 2.5 m from floor.**

### 1.4. Before getting installed (moved) - electrical work

#### ⚠ Caution:

- **Ground the unit.**
  - Do not connect the ground wire to gas or water pipes, lightning rods, or telephone ground lines. Improper grounding may result in electric shock.

## 2. Indoor unit accessories

The unit is provided with the following accessories:

Part No.	Accessories	Qty
1	Insulation pipe	1
2	Tie band	3
3	Drain hose	1
4	Washer	8

- **Install the power cable so that tension is not applied to the cable.**
  - Tension may cause the cable to break and generate heat and cause a fire.
- **Install an leak circuit breaker, as required.**
  - If an leak circuit breaker is not installed, electric shock may result.
- **Use power line cables of sufficient current carrying capacity and rating.**
  - Cables that are too small may leak, generate heat, and cause a fire.
- **Use only a circuit breaker and fuse of the specified capacity.**
  - A fuse or circuit breaker of a larger capacity or a steel or copper wire may result in a general unit failure or fire.
- **Do not wash the air conditioner units.**
  - Washing them may cause an electric shock.
- **Be careful that the installation base is not damaged by long use.**
  - If the damage is left uncorrected, the unit may fall and cause personal injury or property damage.
- **Install the drain piping according to this Installation Manual to ensure proper drainage. Wrap thermal insulation around the pipes to prevent condensation.**
  - Improper drain piping may cause water leakage and damage to furniture and other possessions.
- **Be very careful about product transportation.**
  - Only one person should not carry the product if it weighs more than 20 kg.
  - Some products use PP bands for packaging. Do not use any PP bands for a means of transportation. It is dangerous.
  - Do not touch the heat exchanger fins. Doing so may cut your fingers.
  - When transporting the outdoor unit, suspend it at the specified positions on the unit base. Also support the outdoor unit at four points so that it cannot slip sideways.
- **Safely dispose of the packing materials.**
  - Packing materials, such as nails and other metal or wooden parts, may cause stabs or other injuries.
  - Tear apart and throw away plastic packaging bags so that children will not play with them. If children play with a plastic bag which was not torn apart, they face the risk of suffocation.

### 1.5. Before starting the test run

#### ⚠ Caution:

- **Turn on the power at least 12 hours before starting operation.**
  - Starting operation immediately after turning on the main power switch can result in severe damage to internal parts. Keep the power switch turned on during the operational season.
- **Do not touch the switches with wet fingers.**
  - Touching a switch with wet fingers can cause electric shock.
- **Do not touch the refrigerant pipes during and immediately after operation.**
  - During and immediately after operation, the refrigerant pipes are may be hot and may be cold, depending on the condition of the refrigerant flowing through the refrigerant piping, compressor, and other refrigerant cycle parts. Your hands may suffer burns or frostbite if you touch the refrigerant pipes.
- **Do not operate the air conditioner with the panels and guards removed.**
  - Rotating, hot, or high-voltage parts can cause injuries.
- **Do not turn off the power immediately after stopping operation.**
  - Always wait at least five minutes before turning off the power. Otherwise, water leakage and trouble may occur.

## 3. Selecting an installation site

- Select a site with sturdy fixed surface sufficiently durable against the weight of unit.
- Before installing unit, the routing to carry in unit to the installation site should be determined.
- Select a site where the unit is not affected by entering air.
- Select a site where the flow of supply and return air is not blocked.

- Select a site where refrigerant piping can easily be led to the outside.
- Select a site which allows the supply air to be distributed fully in room.
- Do not install unit at a site with oil splashing or steam in much quantity.
- Do not install unit at a site where combustible gas may generate, flow in, stagnate or leak.
- Do not install unit at a site where equipment generating high frequency waves (a high frequency wave welder for example) is provided.

- Do not install unit at a site where fire detector is located at the supply air side. (Fire detector may operate erroneously due to the heated air supplied during heating operation.)
- When special chemical product may scatter around such as site chemical plants and hospitals, full investigation is required before installing unit. (The plastic components may be damaged depending on the chemical product applied.)
- If the unit is run for long hours when the air above the ceiling is at high temperature/high humidity (dew point above 26 °C), dew condensation may be produced in the indoor unit. When operating the units in this condition, add insulation material (10-20 mm) to the entire surface of the indoor unit to avoid dew condensation.

### 3.1. Install the indoor unit on a ceiling strong enough to sustain its weight

#### ⚠ Warning:

The unit must be securely installed on a structure that can sustain its weight. If the unit is mounted on an unstable structure, it may fall down causing injuries.

## 4. Fixing hanging bolts

### 4.1 Fixing hanging bolts

[Fig. 4.1.1] (P.2)

- Ⓐ Center of gravity

(Give site of suspension strong structure.)

#### Hanging structure

- Ceiling: The ceiling structure varies from building to one another. For detailed information, consult your construction company.

#### Center of gravity and Product Weight

Model name	W	L	X	Y	Z	Product Weight (kg)
PEFY-P20VMS-E	625	952	270	420	105	23
PEFY-P25VMS-E	625	952	270	420	105	23
PEFY-P32VMS-E	625	952	270	420	105	23
PEFY-P40VMS-E	625	952	280	422	104	24
PEFY-P50VMS-E	625	952	280	422	104	24
PEFY-P63VMS-E	625	1152	285	511	104	28

## 5. Installing the unit

### 5.1. Hanging the unit body

- ▶ Bring the indoor unit to an installation site as it is packed.
- ▶ To hang the indoor unit, use a lifting machine to lift and pass through the hanging bolts.

[Fig. 5.1.1] (P.2)

- Ⓐ Unit body
- Ⓑ Lifting machine

[Fig. 5.1.2] (P.2)

- Ⓒ Nuts (field supply)
- Ⓓ Washers (field supply)
- Ⓔ M10 hanging bolt (field supply)

### 3.2. Securing installation and service space

- Select the optimum direction of supply airflow according to the configuration of the room and the installation position.
- As the piping and wiring are connected at the bottom and side surfaces, and the maintenance is made at the same surfaces, allow a proper space properly. For the efficient suspension work and safety, provide a space as much as possible.

[Fig. 3.2.1] (P.2)

- Ⓐ Access door
- Ⓑ Electrical parts box
- Ⓒ Air inlet
- Ⓓ Air outlet
- Ⓔ Ceiling surface
- Ⓕ Service space (viewed from the side)
- Ⓖ Service space (viewed from the direction of arrow)
- ① 600 mm or more
- ② 100 mm or more
- ③ 20 mm or more
- ④ 300 mm or more

### 3.3. Combining indoor units with outdoor units

For combining indoor units with outdoor units, refer to the outdoor unit installation manual.

- If necessary, reinforce the hanging bolts with anti-quake supporting members as countermeasures against earthquakes.

\* Use M10 for hanging bolts and anti-quake supporting members (field supply).

### 5.2. Confirming the unit's position and fixing hanging bolts

#### 5.2. Confirming the unit's position and fixing hanging bolts

- ▶ Use the gage supplied with the panel to confirm that the unit body and hanging bolts are positioned in place. If they are not positioned in place, it may result in dew drops due to wind leak. Be sure to check the positional relationship.
- ▶ Use a level to check that the surface indicated by Ⓐ is at level. Ensure that the hanging bolt nuts are tightened to fix the hanging bolts.
- ▶ To ensure that drain is discharged, be sure to hang the unit at level using a level.

[Fig. 5.2.1] (P.2)

- Ⓐ Indoor unit's bottom surface

#### ⚠ Caution:

Install the unit in horizontal position. If the side with drain port is installed higher, water leakage may be caused.

## 6. Refrigerant pipe and drain pipe specifications

To avoid dew drops, provide sufficient antisweating and insulating work to the refrigerant and drain pipes.

When using commercially available refrigerant pipes, be sure to wind commercially available insulating material (with a heat-resisting temperature of more than 100 °C and thickness given below) onto both liquid and gas pipes.

Insulate all indoor pipes with form polyethylene insulation with a minimum density of 0.03 and a thickness as specified in the table below.

- ① Select the thickness of insulating material by pipe size.

Pipe size	Insulating material's thickness
6.4 mm to 25.4 mm	More than 10 mm
28.6 mm to 38.1 mm	More than 15 mm

- ② If the unit is used on the highest story of a building and under conditions of high temperature and humidity, it is necessary to use pipe size and insulating material's thickness more than those given in the table above.
- ③ If there are customer's specifications, simply follow them.



## 6.1. Refrigerant pipe and drain pipe specifications

Item		Model	R410A		R407C or R22	
			20-25-32-40-50	63	20-25-32-40	50-63*
Refrigerant pipe (Braze connection)	Liquid pipe		ø 6.35	ø 9.52	ø 6.35	ø 9.52
	Gas pipe		ø 12.7	ø 15.88	ø 12.7	ø 15.88
Drain pipe			O.D. ø 32		O.D. ø 32	

\* When the Models P50 are used with R22 or R407C, use the supplied short pipes.

## 6.2. Refrigerant pipe, drain pipe

[Fig. 6.2.1] (P.2)

- Ⓐ Refrigerant pipe (liquid pipe): HP
- Ⓑ Refrigerant pipe (gas pipe): LP
- Ⓒ Drain pipe (O.D. ø32)
- Ⓓ Drain pipe (O.D. ø32, spontaneous draining)

## 7. Connecting refrigerant pipes and drain pipes

### 7.1. Refrigerant piping work

This piping work must be done in accordance with the installation manuals for both outdoor unit and BC controller (simultaneous cooling and heating series R2).

- Series R2 is designed to operate in a system that the refrigerant pipe from an outdoor unit is received by BC controller and branches at the BC controller to connect between indoor units.
- For constraints on pipe length and allowable difference of elevation, refer to the outdoor unit manual.
- The method of pipe connection is brazing connection.

#### ⚠ Caution:

- **Install the refrigerant piping for the indoor unit in accordance with the following.**

1. Cut the tip of the indoor unit piping, remove the gas, and then remove the brazed cap.

[Fig. 7.1.1] (P.3)

- Ⓐ Cut here
- Ⓑ Remove brazed cap

2. Pull out the thermal insulation on the site refrigerant piping, braze the unit piping, and replace the insulation in its original position. Wrap the piping with insulating tape.

#### Note:

- **When blazing the refrigerant pipes, be sure to blaze, after covering a wet cloth to the pipes of the units in order to prevent it from burning and shrinking by heat.**

[Fig. 7.1.2] (P.3)

- Ⓐ Cool by a wet cloth

- **Pay strict attention when wrapping the copper piping since wrapping the piping may cause condensation instead of preventing it.**

[Fig. 7.1.3] (P.3)

- Ⓐ Thermal insulation
- Ⓑ Pull out insulation
- Ⓒ Wrap with damp cloth
- Ⓓ Return to original position
- Ⓔ Ensure that there is no gap here
- Ⓕ Wrap with insulating tape

### Cautions On Refrigerant Piping

- ▶ **Be sure to use non-oxidative brazing for brazing to ensure that no foreign matter or moisture enter into the pipe.**
- ▶ **Be sure to apply refrigerating machine oil over the flare connection seating surface and tighten the connection using a double spanner.**
- ▶ **Provide a metal brace to support the refrigerant pipe so that no load is imparted to the indoor unit end pipe. This metal brace should be provided 50 cm away from the indoor unit's flare connection.**

#### ⚠ Warning:

**When installing and moving the unit, do not charge it with refrigerant other than the refrigerant specified on the unit.**

- Mixing of a different refrigerant, air, etc. may cause the refrigerant cycle to malfunction and result in severe damage.

#### ⚠ Caution:

- **Use refrigerant piping made of C1220 (Cu-DHP) phosphorus deoxidized copper as specified in the JIS H3300 "Copper and copper alloy seamless pipes and tubes". In addition, be sure that the inner and outer surfaces of the pipes are clean and free of hazardous sulphur, oxides, dust/dirt, shaving particles, oils, moisture, or any other contaminant.**
- **Never use existing refrigerant piping.**
  - The large amount of chlorine in conventional refrigerant and refrigerant oil in the existing piping will cause the new refrigerant to deteriorate.

- **Store the piping to be used during installation indoors and keep both ends of the piping sealed until just before brazing.**
  - If dust, dirt, or water gets into the refrigerant cycle, the oil will deteriorate and the compressor may fail.
- **Use Suniso 4GS or 3GS (small amount) refrigerator oil to coat the flare and flange connection part. (For models using R22)**
- **Use ester oil, ether oil or alkylbenzene (small amount) as the refrigerator oil to coat flares and flange connections. (For models using R410A or R407C)**
  - The refrigerant used in the unit is highly hygroscopic and mixes with water and will degrade the refrigerator oil.

### 7.2. Drain piping work

- Ensure that the drain piping is downward (pitch of more than 1/100) to the outdoor (discharge) side. Do not provide any trap or irregularity on the way.
- Ensure that any cross-wise drain piping is less than 20 m (excluding the difference of elevation). If the drain piping is long, provide metal braces to prevent it from waving. Never provide any air vent pipe. Otherwise drain may be ejected.
- Use a hard vinyl chloride pipe VP-25 (with an external diameter of 32 mm) for drain piping.
- Ensure that collected pipes are 10 cm lower than the unit body's drain port.
- Do not provide any odor trap at the drain discharge port.
- Put the end of the drain piping in a position where no odor is generated.
- Do not put the end of the drain piping in any drain where ionic gases are generated.

[Fig. 7.2.1] (P.3)

- Correct piping
- × Wrong piping
- Ⓐ Insulation (9 mm or more)
- Ⓑ Downward slope (1/100 or more)
- Ⓒ Support metal
- Ⓓ Air bleeder
- Ⓔ Raised
- Ⓜ Odor trap

#### Grouped piping

- Ⓓ O. D. ø32 PVC TUBE
- Ⓔ Make it as large as possible. About 10 cm.
- Ⓜ Indoor unit
- Ⓒ Make the piping size large for grouped piping.
- Ⓜ Downward slope (1/100 or more)
- Ⓜ O. D. ø38 PVC TUBE for grouped piping. (9 mm or more insulation)
- Ⓜ Up to 550 mm
- Ⓜ Drain hose (accessory)
- Ⓜ Horizontal or slightly upgradient

1. Insert the drain hose (accessory) into the drain port (insertion margin: 25mm). (The drain hose must not be bent more than 45° to prevent the hose from breaking or clogging.) (Attach the hose with glue, and fix it with the band (small, accessory).)
2. Attach the drain pipe (O.D. ø32 PVC TUBE PV-25, field supply). (Attach the pipe with glue, and fix it with the band (small, accessory).)
3. Perform insulation work on the drain pipe (O.D. ø32 PVC TUBE PV-25) and on the socket (including elbow).
4. Check the drainage. (Refer to [Fig. 7.3.1])
5. Attach the insulating material (accessory), and fix it with the band (large, accessory) to insulate the drain port.

**[Fig. 7.2.2] (P.3)**

- Ⓐ Indoor unit
- Ⓑ Insulation pipe (accessory)
- Ⓒ Tie band (accessory)
- Ⓓ Visible part
- Ⓔ Insertion margin
- Ⓕ Drain hose (accessory)
- Ⓖ Drain pipe (O.D. ø32 PVC TUBE, field supply)
- Ⓗ Insulating material (field supply)
- Ⓛ Tie band (accessory)
- Ⓜ Max.180 ± 5mm
- Ⓝ To be gap free. The joint section of the insulation material meet must be at the top.

**7.3. Confirming drain discharge**

► **Make sure that the drain-up mechanism operates normally for discharge and that there is no water leakage from the connections.**

- Be sure to confirm the above in a period of heating operation.
  - Be sure to confirm the above before ceiling work is done in the case of a new construction.
1. Remove the water supply port cover on the same side as the indoor unit piping.

2. Fill water into the feed water pump using a feed water tank. In filling, be sure to put the end of the pump or tank in a drain pan. (If the insertion is incomplete, water may flow over the machine.)
3. Perform the test run in cooling mode, or turn on the switch SWE on the controller circuit board. (The drain pump and the fan are forced to operate without any remote controller operation.) Make sure using a transparent hose that drain is discharged.

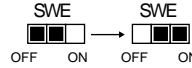

4. After confirmation, cancel the test run mode, and turn off the main power. When the switch SWE has been turned on, turn it off, and attach the water supply port cover into its original position.

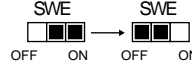

**[Fig. 7.3.1] (P.4)**

- Ⓐ Insert pump's end 2 to 4 cm.
- Ⓑ Remove the water supply port.
- Ⓒ About 2000 cc
- Ⓓ Water
- Ⓔ Filling port
- Ⓕ Screw

**[Fig. 7.3.2] (P.4)**

<Indoor board>

**8. Duct work**

- When connecting ducts, insert a canvas duct between the main body and the duct.
- Use non-combustible duct components.
- Install sufficient thermal insulation to prevent condensation forming on outlet duct flanges and outlet ducts.

**⚠ Caution:**

- **Keep the distance between the inlet grille and the fan over 850 mm. If it is less than 850 mm, install a safety guard not to touch the fan.**

**[Fig. 8.0.1] (P.4)**

- Ⓐ Air inlet
- Ⓑ Air outlet
- Ⓒ Access door
- Ⓓ Ceiling surface
- Ⓔ Canvas duct
- Ⓕ Air filter
- Ⓖ Inlet grille

**9. Electrical wiring**

**Precautions on electrical wiring**

**⚠ Warning:**

**Electrical work should be done by qualified electrical engineers in accordance with "Engineering Standards For Electrical Installation" and supplied installation manuals. Special circuits should also be used. If the power circuit lacks capacity or has an installation failure, it may cause a risk of electric shock or fire.**

1. Be sure to install an earth leakage breaker to the power.
2. Install the unit to prevent that any of the control circuit cables (remote controller, transmission cables) is brought in direct contact with the power cable outside the unit.
3. Ensure that there is no slack on all wire connections.
4. Some cables (power, remote controller, transmission cables) above the ceiling may be bitten by mice. Use as many metal pipes as possible to insert the cables into them for protection.
5. Never connect the power cable to leads for the transmission cables. Otherwise the cables would be broken.

6. Be sure to connect control cables to the indoor unit, remote controller, and the outdoor unit.
7. Put the unit to the ground on the outdoor unit side.
8. Select control cables from the conditions given in page 11.

**⚠ Caution:**

**Be sure to put the unit to the ground on the outdoor unit side. Do not connect the earth cable to any gas pipe, water pipe, lightning rod, or telephone earth cable. Incomplete grounding may cause a risk of electric shock.**

**Types of control cables**

**1. Wiring transmission cables**

- Types of transmission cables  
Design wiring in accordance with the following table <Table 1>.
- Cable diameter  
More than 1.25 mm<sup>2</sup>

**<Table 1>**

System configuration	For a single-refrigerant system		For a multi-refrigerant system
Transmission cable length	Less than 120 m		More than 120 m
Facility example (for noise judgment)	Residence or independent store without noise	Building, clinic, hospital or communications station without noise supposedly generated from inverter equipment, private power generator, high-frequency medical equipment, radio-used communications equipment and so on	Regardless of length
Types of transmission cables	VCTF, VCTFK, CVV, CVS, VVR, VVF, VCT or shielding wire CVVS or CPEVS		
Length	Less than 120 m		Less than 200 m
			All facilities
	Shielding wire CVVS or CPEVS		

## 2. Remote controller cables

	MA remote controller	M-NET remote controller
Types of cables	Sheathed 2-core cable (unshielded) CVV	Sheathed 2-core cable (unshielded) CVV
Cable diameter	0.3 to 1.25 mm <sup>2</sup>	0.3 to 1.25 mm <sup>2</sup>
Length	Less than 200 m	Add any portion in excess of 10 m to within the longest allowable transmission cable length 200 m (Shielding portion is more than 1.25 mm <sup>2</sup> )

### 9.1. Power supply wiring

- Power supply cords of appliances shall not be lighter than design 245 IEC 57 or 227 IEC 57.
- A switch with at least 3 mm contact separation in each pole shall be provided by the Air conditioner installation.

**Power cable size: more than 1.5 mm<sup>2</sup>**

**[Fig. 9.1.1] (P.4)**

- Ⓐ Switch 16 A
- Ⓑ Overcurrent protection 16 A
- Ⓒ Indoor unit
- Ⓓ Total operating current be less than 16 A
- Ⓔ Pull box

**[Selecting non-fuse breaker (NF) or earth leakage breaker (NV)]**

To select NF or NV instead of a combination of Class B fuse with switch, use the following:

- In the case of Class B fuse rated 15 A or 20 A,  
**NF model name (MITSUBISHI): NF30-CS (15 A) (20 A)**  
**NV model name (MITSUBISHI): NV30-CA (15 A) (20 A)**

Use an earth leakage breaker with a sensitivity of less than 30 mA 0.1 s.

#### **⚠ Caution:**

**Do not use anything other than the correct capacity breaker and fuse. Using fuse, wire or copper wire with too large capacity may cause a risk of malfunction or fire.**

### 9.2. Connecting remote controller, indoor and outdoor transmission cables

- Connect indoor unit TB5 and outdoor unit TB3. (Non-polarized 2-wire)  
 The "S" on indoor unit TB5 is a shielding wire connection. For specifications about the connecting cables, refer to the outdoor unit installation manual.
- Install a remote controller following the manual supplied with the remote controller.
- Connect the "1" and "2" on indoor unit TB15 to a MA remote controller. (Non-polarized 2-wire)
- Connect the "M1" and "M2" on indoor unit TB5 to a M-NET remote controller. (Non-polarized 2-wire)
- Connect the remote controller's transmission cable within 10 m using a 0.75 mm<sup>2</sup> core cable. If the distance is more than 10 m, use a 1.25 mm<sup>2</sup> junction cable.

**[Fig. 9.2.1] (P.4) MA Remote controller**

**[Fig. 9.2.2] (P.4) M-NET Remote controller**

- Ⓐ Terminal block for indoor transmission cable
- Ⓑ Terminal block for outdoor transmission cable
- Ⓒ Remote controller

- DC 9 to 13 V between 1 and 2 (MA remote controller)

- DC 24 to 30 V between M1 and M2 (M-NET remote controller)

**[Fig. 9.2.3] (P.4) MA Remote controller**

**[Fig. 9.2.4] (P.4) M-NET Remote controller**

- Ⓐ Non-polarized
- Ⓑ TB15
- Ⓒ Remote Controller
- Ⓓ TB5

- The MA remote controller and the M-NET remote controller cannot be used at the same time or interchangeably.

#### **⚠ Caution:**

**Install wiring so that it is not tight and under tension. Wiring under tension may break, or overheat and burn.**

### 9.3. Connecting electrical connections

Please identify the model name of the operation manual attached on the terminal bed box cover with that shown on the rating name plate.

- Remove the screw (2pcs) holding the cover to dismount the cover.

**[Fig. 9.3.1] (P.5)**

- Ⓐ Screw holding cover (2pcs)
- Ⓑ Cover

- Open knockout holes

(Recommend to use a screwdriver or the like for this work.)

**[Fig. 9.3.2] (P.5)**

- Ⓐ Terminal bed box
- Ⓑ Knockout hole
- Ⓒ Remove

- Fix power source wiring to terminal bed box by using buffer bushing for tensile force. (PG connection or the like.) Connect transmission wiring to transmission terminal bed through the knockout hole of terminal bed box using ordinary bushing.

**[Fig. 9.3.3] (P.5)**

- Ⓔ Use PG bushing to keep the weight of the cable and external force from being applied to the power supply terminal connector. Use a cable tie to secure the cable.
- Ⓕ Power source wiring
- Ⓖ Tensile force
- Ⓖ Use ordinary bushing
- Ⓗ Transmission wiring

- Connect the power source, Earth, transmission and remote controller wiring. The dismounting of the terminal bed box is not needed.

**[Fig. 9.3.4] (P.5)**

- Ⓙ Power source terminal bed
- Ⓚ Terminal bed for indoor transmission
- Ⓛ Terminal bed for remote controller
- Ⓜ To 1-phase power source
- Ⓝ Transmission line DC 30 V
- Ⓞ Terminal bed for outdoor transmission line (TB3)
- Ⓟ Transmission line to the remote controller, terminal bed for indoor unit and BC controller

**[Shield wire connection]**

**[Fig. 9.3.5] (P.5)**

- Ⓐ Terminal bed
- Ⓑ Round terminal
- Ⓒ Shield wire
- Ⓓ The earth wire from two cables are connected together to the S terminal. (Dead-end connection)
- Ⓔ Insulation tape (To keep the earth wire of the shielded cable from coming in contact with the transmission terminal)

- After wiring is complete, make sure again that there is no slack on the connections, and attach the cover onto the terminal bed box in the reverse order of removal.

**Notes:**

- Do not pinch the cables or wires when attaching the terminal bed box cover. Doing so may cause a risk of disconnection.**
- When accommodating the terminal bed box, make sure that the connectors on the box side are not removed. If removed, it cannot operate normally.**

### 9.4. External I/O specifications

#### **⚠ Caution:**

- Wiring should be covered by insulation tube with supplementary insulation.**
- Use relays or switches with IEC or equivalent standard.**
- The electric strength between accessible parts and control circuit should have 2750 V or more.**

## 9.5. Selecting the external static pressure

As the factory setting is for use under an external static pressure of 15 Pa, no switch operation is needed when using under the standard condition.

External static pressure	Switch operation
5 Pa	
15 Pa	
35 Pa	
50 Pa	

[Fig. 9.5.1] (P.5)

<Address board>

## 9.6. Setting addresses

(Be sure to operate with the main power turned OFF.)

[Fig. 9.5.1] (P.5)

<Address board>

- There are two types of rotary switch setting available: setting addresses 1 to 9 and over 10, and setting branch numbers.
  - ① How to set addresses  
Example: If Address is "3", remain SW12 (for over 10) at "0", and match SW11 (for 1 to 9) with "3".
  - ② How to set branch numbers SW14 (Series R2 only)  
The branch number assigned to each indoor unit is the port number of the BC controller to which the indoor unit is connected.  
Leave it to "0" on the non-R2 series of units.
- The rotary switches are all set to "0" when shipped from the factory. These switches can be used to set unit addresses and branch numbers at will.
- The determination of indoor unit addresses varies with the system at site. Set them referring to the Data Book.

## 9.7. Sensing room temperature with the built-in sensor in a remote controller

If you want to sense room temperature with the built-in sensor in a remote controller, set SW1-1 on the control board to "ON". The setting of SW1-7 and SW1-8 as necessary also makes it possible to adjust the air flow at a time when the heating thermometer is OFF.

---

This product is designed and intended for use in the residential, commercial and light-industrial environment.

The product at hand is based on the following EU regulations:

- Low Voltage Directive 73/23/EEC
- Electromagnetic Compatibility Directive 89/336/EEC

Please be sure to put the contact address/telephone number on this manual before handing it to the customer.