

**PEFY-P-VMR-E-L/R  
PEFY-P-VMS1(L)-E  
PEFY-P-VMH-E**

1. SPECIFICATIONS	1 - 4
2. EXTERNAL DIMENSIONS	1 - 10
3. CENTER OF GRAVITY	1 - 15
4. ELECTRICAL WIRING DIAGRAMS	1 - 16
5. SOUND LEVELS	
5-1. Sound levels	1 - 20
5-2. NC curves	1 - 21
5-3. Fan characteristics curves	1 - 28
6. Optional parts for PEFY-P-VMS1L-E,VMH-E	1 - 36

# 1. SPECIFICATIONS

R410A Data G8

PEFY

Model		PEFY-P20VMR-E-L/R	PEFY-P25VMR-E-L/R	PEFY-P32VMR-E-L/R	
Power source		1-phase 220-240V 50Hz / 220-230V 60Hz			
Cooling capacity (Nominal)	*:1 kW	2.2	2.8	3.6	
	*:1 kcal / h	1,900	2,400	3,100	
	*:1 Btu / h	7,500	9,600	12,300	
	*:2 kcal / h	2,000	2,500	3,150	
	*:4 Power input kW	0.06 / 0.06	0.06 / 0.06	0.07 / 0.08	
*:4 Current input A	0.29 / 0.29 (220V)	0.29 / 0.29 (220V)	0.34 / 0.38 (220V)		
Heating capacity (Nominal)	*:3 kW	2.5	3.2	4.0	
	*:3 kcal / h	2,200	2,800	3,400	
	*:3 Btu / h	8,500	10,900	13,600	
	*:4 Power input kW	0.06 / 0.06	0.06 / 0.06	0.07 / 0.08	
	*:4 Current input A	0.29 / 0.29 (220V)	0.29 / 0.29 (220V)	0.34 / 0.38 (220V)	
External finish		Galvanized			
External dimension H x W x D		mm	292 x 640 x 580	292 x 640 x 580	292 x 640 x 580
		in.	11-1/2 x 25-1/4 x 22-7/8	11-1/2 x 25-1/4 x 22-7/8	11-1/2 x 25-1/4 x 22-7/8
Net weight		kg (lb)	18 (40)	18 (40)	18 (40)
Heat exchanger		Cross fin (Aluminum fin and copper tube)			
FAN	Type x Quantity		Sirocco fan x 1	Sirocco fan x 1	Sirocco fan x 1
	External (220V) static press.	Pa	5	5	5
		mmH <sub>2</sub> O	0.5	0.5	0.5
	(230, 240V)	Pa	5	5	5
		mmH <sub>2</sub> O	0.5	0.5	0.5
	Motor type		1-phase induction motor		
	Motor output kW		0.018	0.018	0.023
	Driving mechanism		Direct-driven by motor		
	Airflow rate (Low-Mid-High)	m <sup>3</sup> / min	4.8 - 5.8 - 7.9	4.8 - 5.8 - 7.9	4.8 - 5.8 - 9.3
		L / s	80 - 97 - 132	80 - 97 - 132	80 - 97 - 155
cfm		170 - 205 - 279	170 - 205 - 279	170 - 205 - 328	
Sound pressure level (Low-Mid-High) (measured in anechoic room)	dB <A>	20 - 25 - 30 * (220V)	20 - 25 - 30 * (220V)	20 - 25 - 33 * (220V)	
		21 - 26 - 32 * (230V)	21 - 26 - 32 * (230V)	21 - 26 - 35 * (230V)	
	*:4 dB <A>	22 - 27 - 30 * (240V)	22 - 27 - 30 * (240V)	22 - 27 - 33 * (240V)	
Insulation material		Polystyrene foam, Polyethylene foam, Urethane foam			
Air filter		PP Honeycomb fabric (washable)			
Protection device		Fuse			
Refrigerant control device		LEV			
Connectable outdoor unit		R410A CITY MULTI			
Diameter of refrigerant pipe	Liquid (R410A)	mm (in.)	ø6.35 (ø1/4) Brazed	ø6.35 (ø1/4) Brazed	ø6.35 (ø1/4) Brazed
	Gas (R410A)	mm (in.)	ø12.7 (ø1/2) Brazed	ø12.7 (ø1/2) Brazed	ø12.7 (ø1/2) Brazed
Field drain pipe size		mm (in.)	O.D. 26mm (1)		
Drawing	External		IU-KB94-C854	IU-KB94-C854	IU-KB94-C854
	Wiring		IU-KB94-C858	IU-KB94-C858	IU-KB94-C858
	Refrigerant cycle		-	-	-
Standard attachment	Document		Installation Manual, Instruction Book		
	Accessory		Drain hose I.D. 26mm (1) (flexible joint)		
Remark		* Above sound pressure level is tested in rear air inlet case. It will be a little higher in bottom air inlet case.			
Installation		Details on foundation work, duct work, insulation work, electrical wiring, power source switch, and other items shall be referred to the Installation Manual.			
Note :		*:1 Nominal cooling conditions	*:2 Nominal cooling conditions	*:3 Nominal heating conditions	Unit converter
		Indoor : 27°CDB/19°CWB (81°FDB/66°FWB)	27°CDB/19.5°CWB (81°FDB/67°FWB)	20°CDB (68°FDB)	kcal/h = kW x 860
		Outdoor : 35°CDB (95°FDB)	35°CDB (95°FDB)	7°CDB/6°CWB (45°FDB/43°FWB)	Btu/h = kW x 3,412
		Pipe length : 7.5 m (24-9/16 ft)	5 m (16-3/8 ft)	7.5 m (24-9/16 ft)	cfm = m <sup>3</sup> /min x 35.31
		Level difference : 0 m (0 ft)	0 m (0 ft)	0 m (0 ft)	lb = kg / 0.4536
		* Nominal conditions *:1, *:3 are subject to JIS B8615-1.			*Above specification data is subject to rounding variation.
		* Due to continuing improvement, above specification may be subject to change without notice.			
		*:4 The values are measured at the rated external static pressure.			
		*:5 The figure in < > indicates the value when external static pressure is changed.			

Ref.: Spec\_PEFY-P-VMR-E-L/R

# 1. SPECIFICATIONS

Model			PEFY-P15VMS1(L)-E	PEFY-P20VMS1(L)-E	PEFY-P25VMS1(L)-E	PEFY-P32VMS1(L)-E	
Power source			220-240V (50/60Hz)				
Cooling capacity (Nominal)	*1	kW	1.7	2.2	2.8	3.6	
		kcal / h	1,450	1,900	2,400	3,100	
		Btu / h	5,800	7,500	9,600	12,300	
	*2	kcal / h	1,500	2,000	2,500	3,150	
		Power input	kW	0.05<0.03>	0.05<0.03>	0.06<0.04>	0.07<0.05>
*4	Current input	A	0.42<0.31>	0.47<0.36>	0.50<0.39>	0.50<0.39>	
Heating capacity (Nominal )	*3	kW	1.9	2.5	3.2	4.0	
		kcal / h	1,600	2,200	2,800	3,400	
		Btu / h	6,500	8,500	10,900	13,600	
	*4	Power input	kW	0.03<0.03>	0.03<0.03>	0.04<0.04>	0.05<0.05>
		Current input	A	0.31<0.31>	0.36<0.36>	0.39<0.39>	0.39<0.39>
External finish			Galvanized				
External dimension H x W x D		mm	200 x 790 x 700	200 x 790 x 700	200 x 790 x 700	200 x 790 x 700	
		in.	7-7/8 x 31-1/8 x 27-9/16	7-7/8 x 31-1/8 x 27-9/16	7-7/8 x 31-1/8 x 27-9/16	7-7/8 x 31-1/8 x 27-9/16	
Net weight		kg (lb)	19(42)<18(40)>	19(42)<18(40)>	19(42)<18(40)>	20(44)<19(42)>	
Heat exchanger			Cross fin (Aluminum fin and copper tube)				
FAN	Type x Quantity		Sirocco fan x 2				
	External (220V) static press. (230, 240V)	Pa	<5> - 15 - <35> - <50>	<5> - 15 - <35> - <50>	<5> - 15 - <35> - <50>	<5> - 15 - <35> - <50>	
		mmH <sub>2</sub> O	<0.5> - 1.5 - <3.6> - <5.1>	<0.5> - 1.5 - <3.6> - <5.1>	<0.5> - 1.5 - <3.6> - <5.1>	<0.5> - 1.5 - <3.6> - <5.1>	
		Pa	<5> - 15 - <35> - <50>	<5> - 15 - <35> - <50>	<5> - 15 - <35> - <50>	<5> - 15 - <35> - <50>	
	*5	mmH <sub>2</sub> O	<0.5> - 1.5 - <3.6> - <5.1>	<0.5> - 1.5 - <3.6> - <5.1>	<0.5> - 1.5 - <3.6> - <5.1>	<0.5> - 1.5 - <3.6> - <5.1>	
	Motor type		DC brushless motor				
	Motor output		kW	0.096	0.096	0.096	0.096
	Driving mechanism		Direct-driven				
	Airflow rate (Low-Mid-High)	m <sup>3</sup> / min		5 - 6 - 7	5.5 - 6.5 - 8	5.5 - 7 - 9	6 - 8 - 10
		L / s		83 - 100 - 117	91 - 108 - 133	91 - 117 - 150	100 - 133 - 167
cfm		176 - 212 - 247	194 - 229 - 282	194 - 247 - 317	212 - 282 - 353		
Sound pressure level (Low-Mid-High) (measured in anechoic room)		*4 dB <A>	22 - 24 - 28(15Pa,220-240V)	23 - 25 - 29(15Pa,220-240V)	24 - 26 - 30(15Pa,220-240V)	24 - 27 - 32(15Pa,220-240V)	
Insulation material			Polystyrene foam, Polyethylene foam, Urethane foam				
Air filter			PP Honeycomb fabric (washable)				
Protection device			Fuse				
Refrigerant control device			LEV				
Connectable outdoor unit			R410A CITY MULTI PURY-P-Y(S)JM-A, PUHY-P-Y(S)JM-A PUMY-P100-140VHMB, PUMY-P100-140YHMB PQRY-P-Y(S)HM-A, PQHY-P-Y(S)HM-A				
Diameter of refrigerant pipe	Liquid (R410A)	mm (in.)	ø6.35 (ø1/4) Brazed	ø6.35 (ø1/4) Brazed	ø6.35 (ø1/4) Brazed	ø6.35 (ø1/4) Brazed	
	Gas (R410A)	mm (in.)	ø12.7 (ø1/2) Brazed	ø12.7 (ø1/2) Brazed	ø12.7 (ø1/2) Brazed	ø12.7 (ø1/2) Brazed	
Field drain pipe size		mm (in.)	O.D. 32mm (1-1/4)				
Drawing	External		IU-KB94-G728<IU-KB94-G731>	IU-KB94-G728<IU-KB94-G731>	IU-KB94-G728<IU-KB94-G731>	IU-KB94-G728<IU-KB94-G731>	
	Wiring		IU-KB94-G668	IU-KB94-G668	IU-KB94-G668	IU-KB94-G668	
	Refrigerant cycle		-	-	-	-	
Standard attachment	Document		Installation Manual, Instruction Book				
	Accessory		Drain hose (flexible joint)				
Remark	Optional parts						
	Drain pump		<PAC-KE07DM-E>	<PAC-KE07DM-E>	<PAC-KE07DM-E>	<PAC-KE07DM-E>	
	Control Box Replace kit		<PAC-KE70HS-E>	<PAC-KE70HS-E>	<PAC-KE70HS-E>	<PAC-KE70HS-E>	
	Installation		Details on foundation work, duct work, insulation work, electrical wiring, power source switch, and other items shall be referred to the Installation Manual.				
<b>Note :</b>			*1 Nominal cooling conditions	*2 Nominal cooling conditions	*3 Nominal heating conditions	Unit converter	
Indoor :			27°CDB/19°CWB (81°FDB/66°FWB)	27°CDB/19.5°CWB (81°FDB/67°FWB)	20°CDB (68°FDB)	kcal/h = kW x 860	
Outdoor :			35°CDB (95°FDB)	35°CDB (95°FDB)	7°CDB/6°CWB (45°FDB/43°FWB)	Btu/h = kW x 3,412	
Pipe length :			7.5 m (24-9/16 ft)	5 m (16-3/8 ft)	7.5 m (24-9/16 ft)	cfm = m <sup>3</sup> /min x 35.31	
Level difference :			0 m (0 ft)	0 m (0 ft)	0 m (0 ft)	lb = kg / 0.4536	
* Nominal conditions *1, *3 are subject to JIS B8615-1.			* The external static pressure is set to 15 Pa at factory shipment.			*Above specification data is subject to rounding variation.	
* Due to continuing improvement, above specification may be subject to change without notice.			* < > is in case of PEFY-P-VMS1L-E model.				
*4 The values are measured at the rated external static pressure.							
*5 The figure in < > indicates the value when external static pressure is changed.							

# 1. SPECIFICATIONS

R410A Data G8

PEFY

Model		PEFY-P40VMS1(L)-E	PEFY-P50VMS1(L)-E	PEFY-P63VMS1(L)-E		
Power source		220-240V (50/60Hz)				
Cooling capacity (Nominal)	*1	kW	4.5	5.6	7.1	
	*1	kcal / h	3,900	4,800	6,100	
		Btu / h	15,400	19,100	24,200	
	*2	kcal / h	4,000	5,000	6,300	
	*4	Power input	kW	0.07<0.05>	0.09<0.07>	0.09<0.07>
	*4	Current input	A	0.56<0.45>	0.67<0.56>	0.72<0.61>
Heating capacity (Nominal)	*3	kW	5.0	6.3	8.0	
		kcal / h	4,300	5,400	6,900	
		Btu / h	17,100	21,500	27,300	
	*4	Power input	kW	0.05<0.05>	0.07<0.07>	0.07<0.07>
		*4	Current input	A	0.45<0.45>	0.56<0.56>
External finish		Galvanized				
External dimension H x W x D		mm	200 x 990 x 700	200 x 990 x 700	200 x 1190 x 700	
		in.	7-7/8 x 39 x 27-9/16	7-7/8 x 39 x 27-9/16	7-7/8 x 46-7/8 x 27-9/16	
Net weight		kg (lb)	24(53)<23(51)>	24(53)<23(51)>	28(62)<27(60)>	
Heat exchanger		Cross fin (Aluminum fin and copper tube)				
FAN	Type x Quantity		Sirocco fan x 3	Sirocco fan x 3	Sirocco fan x 4	
	External (220V)	Pa	<5> - 15 - <35> - <50>	<5> - 15 - <35> - <50>	<5> - 15 - <35> - <50>	
		static press. mmH <sub>2</sub> O	<0.5> - 1.5 - <3.6> - <5.1>	<0.5> - 1.5 - <3.6> - <5.1>	<0.5> - 1.5 - <3.6> - <5.1>	
	(230, 240V)	Pa	<5> - 15 - <35> - <50>	<5> - 15 - <35> - <50>	<5> - 15 - <35> - <50>	
		*5 mmH <sub>2</sub> O	<0.5> - 1.5 - <3.6> - <5.1>	<0.5> - 1.5 - <3.6> - <5.1>	<0.5> - 1.5 - <3.6> - <5.1>	
	Motor type		DC brushless motor			
	Motor output		kW	0.096	0.096	0.096
	Driving mechanism		Direct-driven			
	Airflow rate (Low-Mid-High)	m <sup>3</sup> / min		8 - 9.5 - 11	9.5 - 11 - 13	12 - 14 - 16.5
		L / s		133 - 158 - 183	158 - 183 - 217	200 - 233 - 275
cfm		282 - 335 - 388	335 - 388 - 459	424 - 494 - 583		
Sound pressure level (Low-Mid-High) (measured in anechoic room)		*4 dB <A>	28 - 30 - 33 (15Pa,220-240V)	30 - 32 - 35 (15Pa,220-240V)	30 - 33 - 36 (15Pa,220-240V)	
Insulation material		Polystyrene foam, Polyethylene foam, Urethane foam				
Air filter		PP Honeycomb fabric (washable)				
Protection device		Fuse				
Refrigerant control device		LEV				
Connectable outdoor unit		R410A CITY MULTI				
Diameter of refrigerant pipe	Liquid (R410A)	mm (in.)	ø6.35 (ø1/4) Brazed	ø6.35 (ø1/4) Brazed	ø9.52 (ø3/8) Brazed	
	Gas (R410A)	mm (in.)	ø12.7 (ø1/2) Brazed	ø12.7 (ø1/2) Brazed	ø15.88 (ø5/8) Brazed	
Field drain pipe size		mm (in.)	O.D. 32mm (1-1/4)			
Drawing	External		IU-KB94-G728(IU-KB94-G731)	IU-KB94-G728(IU-KB94-G731)	IU-KB94-G728(IU-KB94-G731)	
	Wiring		IU-KB94-G668	IU-KB94-G668	IU-KB94-G668	
	Refrigerant cycle		-	-	-	
Standard attachment	Document		Installation Manual, Instruction Book			
	Accessory		Drain hose (flexible joint)			
Remark	Optional parts					
	Drain pump		<PAC-KE07DM-E>	<PAC-KE07DM-E>	<PAC-KE07DM-E>	
	Control Box Replace kit		<PAC-KE70HS-E>	<PAC-KE70HS-E>	<PAC-KE70HS-E>	
	Installation		Details on foundation work, duct work, insulation work, electrical wiring, power source switch, and other items shall be referred to the Installation Manual.			
<b>Note :</b>		*1 Nominal cooling conditions	*2 Nominal cooling conditions	*3 Nominal heating conditions	Unit converter	
Indoor :		27°CDB/19°CWB (81°FDB/66°FWB)	27°CDB/19.5°CWB (81°FDB/67°FWB)	20°CDB (68°FDB)	kcal/h = kW x 860	
Outdoor :		35°CDB (95°FDB)	35°CDB (95°FDB)	7°CDB/6°CWB (45°FDB/43°FWB)	Btu/h = kW x 3,412	
Pipe length :		7.5 m (24-9/16 ft)	5 m (16-3/8 ft)	7.5 m (24-9/16 ft)	cfm = m <sup>3</sup> /min x 35.31	
Level difference :		0 m (0 ft)	0 m (0 ft)	0 m (0 ft)	lb = kg / 0.4536	
* Nominal conditions *1, *3 are subject to JIS B8615-1.				* The external static pressure is set to 15 Pa at factory shipment.	*Above specification data is subject to rounding variation.	
* Due to continuing improvement, above specification may be subject to change without notice.				* < > is in case of PEFY-P-VMS1L-E model.		
*4 The values are measured at the rated external static pressure.						
*5 The figure in < > indicates the value when external static pressure is changed.						

Ref.: Spec\_PEFY-P-VMS-E\_1

# 1. SPECIFICATIONS

Model			PEFY-P40VMH-E	PEFY-P50VMH-E	PEFY-P63VMH-E	PEFY-P71VMH-E																				
Power source			1-phase 220-240V 50Hz/60Hz																							
Cooling capacity (Nominal)	*:1	kW	4.5	5.6	7.1	8.0																				
	*:1	kcal / h	3,900	4,800	6,100	6,900																				
	*:1	Btu / h	15,400	19,100	24,200	27,300																				
	*:2	kcal / h	4,000	5,000	6,300	7,100																				
	*:4	Power input	kW	0.19 / 0.23	0.19 / 0.23	0.24 / 0.30	0.26 / 0.33																			
	*:4	Current input	A	0.88 / 1.06	0.88 / 1.06	1.12 / 1.38	1.20 / 1.51																			
Heating capacity (Nominal )	*:3	kW	5.0	6.3	8.0	9.0																				
	*:3	kcal / h	4,300	5,400	6,900	7,700																				
	*:3	Btu / h	17,100	21,500	27,300	30,700																				
	*:4	Power input	kW	0.19 / 0.23	0.19 / 0.23	0.24 / 0.30	0.26 / 0.33																			
	*:4	Current input	A	0.88 / 1.06	0.88 / 1.06	1.12 / 1.38	1.20 / 1.51																			
External finish			Galvanized																							
External dimension H x W x D		mm	380 x 750 x 900	380 x 750 x 900	380 x 750 x 900	380 x 1,000 x 900																				
		in.	15 x 29-9/16 x 35-7/16	15 x 29-9/16 x 35-7/16	15 x 29-9/16 x 35-7/16	15 x 39-3/8 x 35-7/16																				
Net weight		kg (lb)	44 (98)	45 (100)	45 (100)	50 (111)																				
Heat exchanger			Cross fin (Aluminum fin and copper tube)																							
FAN	Type x Quantity		Sirocco fan x 1	Sirocco fan x 1	Sirocco fan x 1	Sirocco fan x 1																				
	External (220V) static press.	Pa	<50> - 100 - <200>	<50> - 100 - <200>	<50> - 100 - <200>	<50> - 100 - <200>																				
		mmHzO	<5.1> - 10.2 - <20.4>	<5.1> - 10.2 - <20.4>	<5.1> - 10.2 - <20.4>	<5.1> - 10.2 - <20.4>																				
	(230, 240V)	Pa	<100> - 150 - <200>	<100> - 150 - <200>	<100> - 150 - <200>	<100> - 150 - <200>																				
		mmHzO	<10.2> - 15.3 - <20.4>	<10.2> - 15.3 - <20.4>	<10.2> - 15.3 - <20.4>	<10.2> - 15.3 - <20.4>																				
	Motor type		1-phase induction motor																							
	Motor output		kW	0.080	0.080	0.120	0.140																			
	Driving mechanism		Direct-driven by motor																							
	Airflow rate (Low-Mid-High)	m <sup>3</sup> / min		10.0 - 14.0	10.0 - 14.0	13.5 - 19.0	15.5 - 22.0																			
		L / s		167 - 233	167 - 233	225 - 317	258 - 367																			
cfm		353 - 494	353 - 494	477 - 671	547 - 777																					
Sound pressure level (Low-Mid-High) (measured in anechoic room)		dB <A>	27 - 34 (220V)	27 - 34 (220V)	32 - 38 (220V)	32 - 39 (220V)																				
		*:4 dB <A>	31 - 37 (230, 240V)	31 - 37 (230, 240V)	36 - 41 (230, 240V)	35 - 41 (230, 240V)																				
Insulation material			Polystyrene foam, Polyethylene foam, Urethane foam																							
Air filter			Optional long life filter (Synthetic fiber unwoven cloth filter) and filter box are recommended.																							
Protection device			Fuse																							
Refrigerant control device			LEV																							
Connectable outdoor unit			R410A CITY MULTI																							
Diameter of refrigerant pipe	Liquid (R410A)	mm (in.)	ø6.35 (ø1/4) Flare	ø6.35 (ø1/4) Flare	ø9.52 (ø3/8) Flare	ø9.52 (ø3/8) Flare																				
	Gas (R410A)	mm (in.)	ø12.7 (ø1/2) Flare	ø12.7 (ø1/2) Flare	ø15.88 (ø5/8) Flare	ø15.88 (ø5/8) Flare																				
Field drain pipe size		mm (in.)	O.D. 32mm (1-1/4)																							
Drawing	External		IU-W27-5924																							
	Wiring		IU-W65-3956																							
	Refrigerant cycle		-																							
Standard attachment	Document		Installation Manual, Instruction Book																							
	Accessory		Drain hose I.D. 32mm (1-1/4) (flexible joint)																							
Remark	Optional parts																									
	Long life filter		PAC-KE86LAF	PAC-KE86LAF	PAC-KE86LAF	PAC-KE88LAF																				
	Filter box		PAC-KE63TB-F	PAC-KE63TB-F	PAC-KE63TB-F	PAC-KE80TB-F																				
	Drain pump		PAC-KE04DM-F	PAC-KE04DM-F	PAC-KE04DM-F	PAC-KE04DM-F																				
Installation		Details on foundation work, duct work, insulation work, electrical wiring, power source switch, and other items shall be referred to the Installation Manual.																								
<p><b>Note :</b></p> <table border="0"> <tr> <td>*:1 Nominal cooling conditions</td> <td>*:2 Nominal cooling conditions</td> <td>*:3 Nominal heating conditions</td> <td>Unit converter</td> </tr> <tr> <td>Indoor : 27°CDB/19°CWB (81°FDB/66°FWB)</td> <td>27°CDB/19.5°CWB (81°FDB/67°FWB)</td> <td>20°CDB (68°FDB)</td> <td>kcal/h = kW x 860</td> </tr> <tr> <td>Outdoor : 35°CDB (95°FDB)</td> <td>35°CDB (95°FDB)</td> <td>7°CDB/6°CWB (45°FDB/43°FWB)</td> <td>Btu/h = kW x 3,412</td> </tr> <tr> <td>Pipe length : 7.5 m (24-9/16 ft)</td> <td>5 m (16-3/8 ft)</td> <td>7.5 m (24-9/16 ft)</td> <td>cfm = m<sup>3</sup>/min x 35.31</td> </tr> <tr> <td>Level difference : 0 m (0 ft)</td> <td>0 m (0 ft)</td> <td>0 m (0 ft)</td> <td>lb = kg / 0.4536</td> </tr> </table> <p>* Nominal conditions *:1, *:3 are subject to JIS B8615-1.          * Due to continuing improvement, above specification may be subject to change without notice.          *:4 The values are measured at the rated external static pressure.          *:5 The figure in &lt; &gt; indicates the value when external static pressure is changed.</p>							*:1 Nominal cooling conditions	*:2 Nominal cooling conditions	*:3 Nominal heating conditions	Unit converter	Indoor : 27°CDB/19°CWB (81°FDB/66°FWB)	27°CDB/19.5°CWB (81°FDB/67°FWB)	20°CDB (68°FDB)	kcal/h = kW x 860	Outdoor : 35°CDB (95°FDB)	35°CDB (95°FDB)	7°CDB/6°CWB (45°FDB/43°FWB)	Btu/h = kW x 3,412	Pipe length : 7.5 m (24-9/16 ft)	5 m (16-3/8 ft)	7.5 m (24-9/16 ft)	cfm = m <sup>3</sup> /min x 35.31	Level difference : 0 m (0 ft)	0 m (0 ft)	0 m (0 ft)	lb = kg / 0.4536
*:1 Nominal cooling conditions	*:2 Nominal cooling conditions	*:3 Nominal heating conditions	Unit converter																							
Indoor : 27°CDB/19°CWB (81°FDB/66°FWB)	27°CDB/19.5°CWB (81°FDB/67°FWB)	20°CDB (68°FDB)	kcal/h = kW x 860																							
Outdoor : 35°CDB (95°FDB)	35°CDB (95°FDB)	7°CDB/6°CWB (45°FDB/43°FWB)	Btu/h = kW x 3,412																							
Pipe length : 7.5 m (24-9/16 ft)	5 m (16-3/8 ft)	7.5 m (24-9/16 ft)	cfm = m <sup>3</sup> /min x 35.31																							
Level difference : 0 m (0 ft)	0 m (0 ft)	0 m (0 ft)	lb = kg / 0.4536																							
<p>*Above specification data is subject to rounding variation.</p>																										

# 1. SPECIFICATIONS

R410A Data G8

PEFY

Model		PEFY-P80VMH-E	PEFY-P100VMH-E	PEFY-P125VMH-E	PEFY-P140VMH-E		
Power source		1-phase 220-240V 50Hz/60Hz					
Cooling capacity (Nominal)	*1	kW	9.0	11.2	14.0	16.0	
	*1	kcal / h	7,700	9,600	12,000	13,800	
	*1	Btu / h	30,700	38,200	47,800	54,600	
	*2	kcal / h	8,000	10,000	12,500	14,000	
	*4	Power input	kW	0.32 / 0.40	0.48 / 0.58	0.48 / 0.58	0.48 / 0.59
*4	Current input	A	1.47 / 1.83	2.34 / 2.66	2.34 / 2.66	2.35 / 2.70	
Heating capacity (Nominal )	*3	kW	10.0	12.5	16.0	18.0	
	*3	kcal / h	8,600	10,800	13,800	15,500	
	*3	Btu / h	34,100	42,700	54,600	61,400	
	*4	Power input	kW	0.32 / 0.40	0.48 / 0.58	0.48 / 0.58	0.48 / 0.59
	*4	Current input	A	1.47 / 1.83	2.34 / 2.66	2.34 / 2.66	2.35 / 2.70
External finish		Galvanized					
External dimension H x W x D		mm	380 x 1,000 x 900	380 x 1,200 x 900	380 x 1,200 x 900	380 x 1,200 x 900	
		in.	15 x 39-3/8 x 35-7/16	15 x 47-1/4 x 35-7/16	15 x 47-1/4 x 35-7/16	15 x 47-1/4 x 35-7/16	
Net weight		kg (lb)	50 (111)	70 (155)	70 (155)	70 (155)	
Heat exchanger		Cross fin (Aluminum fin and copper tube)					
FAN	Type x Quantity		Sirocco fan x 1	Sirocco fan x 2	Sirocco fan x 2	Sirocco fan x 2	
	External (220V) static press.	Pa	<50> - 100 - <200>	<50> - 100 - <200>	<50> - 100 - <200>	<50> - 100 - <200>	
		mmH <sub>2</sub> O	<5.1> - 10.2 - <20.4>	<5.1> - 10.2 - <20.4>	<5.1> - 10.2 - <20.4>	<5.1> - 10.2 - <20.4>	
	(230, 240V)	Pa	<100> - 150 - <200>	<100> - 150 - <200>	<100> - 150 - <200>	<100> - 150 - <200>	
		mmH <sub>2</sub> O	<10.2> - 15.3 - <20.4>	<10.2> - 15.3 - <20.4>	<10.2> - 15.3 - <20.4>	<10.2> - 15.3 - <20.4>	
	Motor type		1-phase induction motor				
	Motor output		kW	0.180	0.260	0.260	0.260
	Driving mechanism		Direct-driven by motor				
	Airflow rate (Low-Mid-High)	m <sup>3</sup> / min		18.0 - 25.0	26.5 - 38.0	26.5 - 38.0	28.0 - 40.0
		L / s		300 - 417	442 - 633	442 - 633	467 - 667
cfm		636 - 883	936 - 1,342	936 - 1,342	989 - 1,413		
Sound pressure level (Low-Mid-High) (measured in anechoic room)		*4	dB <A>	35 - 41 (220V)	34 - 42 (220V)	34 - 42 (220V)	34 - 42 (220V)
		dB <A>	38 - 43 (230, 240V)	38 - 44 (230, 240V)	38 - 44 (230, 240V)	38 - 44 (230, 240V)	
Insulation material		Polystyrene foam, Polyethylene foam, Urethane foam					
Air filter		Option : Synthetic fiber unwoven cloth filter (long life)					
Protection device		Fuse					
Refrigerant control device		LEV					
Connectable outdoor unit		R410A CITY MULTI					
Diameter of refrigerant pipe	Liquid (R410A)	mm (in.)	ø9.52 (ø3/8) Flare	ø9.52 (ø3/8) Flare	ø9.52 (ø3/8) Flare	ø9.52 (ø3/8) Flare	
	Gas (R410A)	mm (in.)	ø15.88 (ø5/8) Flare	ø15.88 (ø5/8) Flare	ø15.88 (ø5/8) Flare	ø15.88 (ø5/8) Flare	
Field drain pipe size		mm (in.)	O.D. 32mm (1-1/4)				
Drawing	External		IU-W27-5924				
	Wiring		IU-W65-3956				
	Refrigerant cycle		-				
Standard attachment	Document		Installation Manual, Instruction Book				
	Accessory		Drain hose I.D. 32mm (1-1/4) (flexible joint)				
Remark	Optional parts						
	Long life filter		PAC-KE88LAF	PAC-KE89LAF	PAC-KE89LAF	PAC-KE89LAF	
	Filter box		PAC-KE80TB-F	PAC-KE140TB-F	PAC-KE140TB-F	PAC-KE140TB-F	
	Drain pump		PAC-KE04DM-F	PAC-KE04DM-F	PAC-KE04DM-F	PAC-KE04DM-F	
Installation		Details on foundation work, duct work, insulation work, electrical wiring, power source switch, and other items shall be referred to the Installation Manual.					
<b>Note :</b>		*1 Nominal cooling conditions	*2 Nominal cooling conditions	*3 Nominal heating conditions	Unit converter		
Indoor :		27°CDB/19°CWB (81°FDB/66°FWB)	27°CDB/19.5°CWB (81°FDB/67°FWB)	20°CDB (68°FDB)	kcal/h = kW x 860		
Outdoor :		35°CDB (95°FDB)	35°CDB (95°FDB)	7°CDB/6°CWB (45°FDB/43°FWB)	Btu/h = kW x 3,412		
Pipe length :		7.5 m (24-9/16 ft)	5 m (16-3/8 ft)	7.5 m (24-9/16 ft)	cfm = m <sup>3</sup> /min x 35.31		
Level difference :		0 m (0 ft)	0 m (0 ft)	0 m (0 ft)	lb = kg / 0.4536		
* Nominal conditions *1, *3 are subject to JIS B8615-1.						*Above specification data is subject to rounding variation.	
* Due to continuing improvement, above specification may be subject to change without notice.							
*4 The values are measured at the rated external static pressure.							
*5 The figure in < > indicates the value when external static pressure is changed.							

Ref.: Spec\_PEFY-P-VMH-E\_2

# 1. SPECIFICATIONS

Model		PEFY-P200VMH-E	PEFY-P250VMH-E			
Power source		3-phase, 4-wire, 380-415V 50/60Hz				
Cooling capacity (Nominal)	*:1	kW	22.4	28.0		
	*:1	kcal / h	19,300	24,100		
	*:1	Btu / h	76,400	95,500		
	*:2	kcal / h	20,000	25,000		
	*:4	Power input	kW	0.99 / 1.14	1.23 / 1.41	
*:4	Current input	A	1.62 / 1.86	2.0 / 2.3		
Heating capacity (Nominal )	*:3	kW	25.0	31.5		
	*:3	kcal / h	21,500	27,100		
	*:3	Btu / h	85,300	107,500		
	*:4	Power input	kW	0.99 / 1.14	1.23 / 1.41	
	*:4	Current input	A	1.62 / 1.86	2.0 / 2.3	
External finish		Galvanized				
External dimension H x W x D		mm	470 X 1,250 X 1,120	470 X 1,250 X 1,120		
		in.	18-9/16 x 49-1/4 x 44-1/8	18-9/16 x 49-1/4 x 44-1/8		
Net weight		kg (lb)	100 (221)	100 (221)		
Heat exchanger		Cross fin (Aluminum fin and copper tube)				
FAN	Type x Quantity		Sirocco fan x 2	Sirocco fan x 2		
	External (380V) static press. (400, 415V)	Pa	110- 220	110- 220		
		mmH <sub>2</sub> O	11.2- 22.4	11.2- 22.4		
		Pa	130- 260	130- 260		
		*:5 mmH <sub>2</sub> O	13.3- 26.5	13.3- 26.5		
	Motor type		3-phase induction motor			
	Motor output		kW	0.760	1.080	
	Driving mechanism		Direct-driven by motor			
	Airflow rate (Low-Mid-High)	m <sup>3</sup> / min	58	72		
		L / s	967	1,200		
cfm		2,048	2,543			
Sound pressure level (Low-Mid-High) (measured in anechoic room)	dB <A>	42 / 45 (380V)	50 / 52 (220V)			
	*:4 dB <A>	44 / 47 (400, 415V)	52 / 54 (230, 240V)			
Insulation material		Polystyrene foam, Polyethylene foam, Urethane foam				
Air filter		Option : Synthetic fiber unwoven cloth filter (long life)				
Protection device		Fuse				
Refrigerant control device		LEV				
Connectable outdoor unit		R410A CITY MULTI				
Diameter of refrigerant pipe	Liquid (R410A)	mm (in.)	ø9.52 (ø3/8) Brazed	ø9.52 (ø3/8) Brazed		
	Gas (R410A)	mm (in.)	ø19.05 (ø3/4) Brazed	ø22.2 (ø7/8) Brazed		
Field drain pipe size		mm (in.)	O.D. 32mm (1-1/4)			
Drawing	External		IU-W27-5925			
	Wiring		IU-W65-3957			
	Refrigerant cycle		-			
Standard attachment	Document		Installation Manual, Instruction Book			
	Accessory		Drain hose I.D. 32mm (1-1/4) (flexible joint)			
Remark	Optional parts					
	Long life filter		PAC-KE85LAF	PAC-KE85LAF		
	Filter box		PAC-KE250TB-F	PAC-KE250TB-F		
	Drain pump		PAC-KE04DM-F	PAC-KE04DM-F		
	Installation		Details on foundation work, duct work, insulation work, electrical wiring, power source switch, and other items shall be referred to the Installation Manual.			
<b>Note :</b>		*:1 Nominal cooling conditions	*:2 Nominal cooling conditions	*:3 Nominal heating conditions	Unit converter	
Indoor :		27°CDB/19°CWB (81°FDB/66°FWB)	27°CDB/19.5°CWB (81°FDB/67°FWB)	20°CDB (68°FDB)	kcal/h = kW x 860	
Outdoor :		35°CDB (95°FDB)	35°CDB (95°FDB)	7°CDB/6°CWB (45°FDB/43°FWB)	Btu/h = kW x 3,412	
Pipe length :		7.5 m (24-9/16 ft)	5 m (16-3/8 ft)	7.5 m (24-9/16 ft)	cfm = m <sup>3</sup> /min x 35.31	
Level difference :		0 m (0 ft)	0 m (0 ft)	0 m (0 ft)	lb = kg / 0.4536	
* Nominal conditions *:1, *:3 are subject to JIS B8615-1.						
* Due to continuing improvement, above specification may be subject to change without notice.						
*:4 The values are measured at the rated external static pressure.						
*:5 The figure in < > indicates the value when external static pressure is changed.						
		*Above specification data is subject to rounding variation.				

PEFY

## PEFY-P20,25,32VMR-E-L/R

Drw. : IU-KB94-C854  
Unit : mm

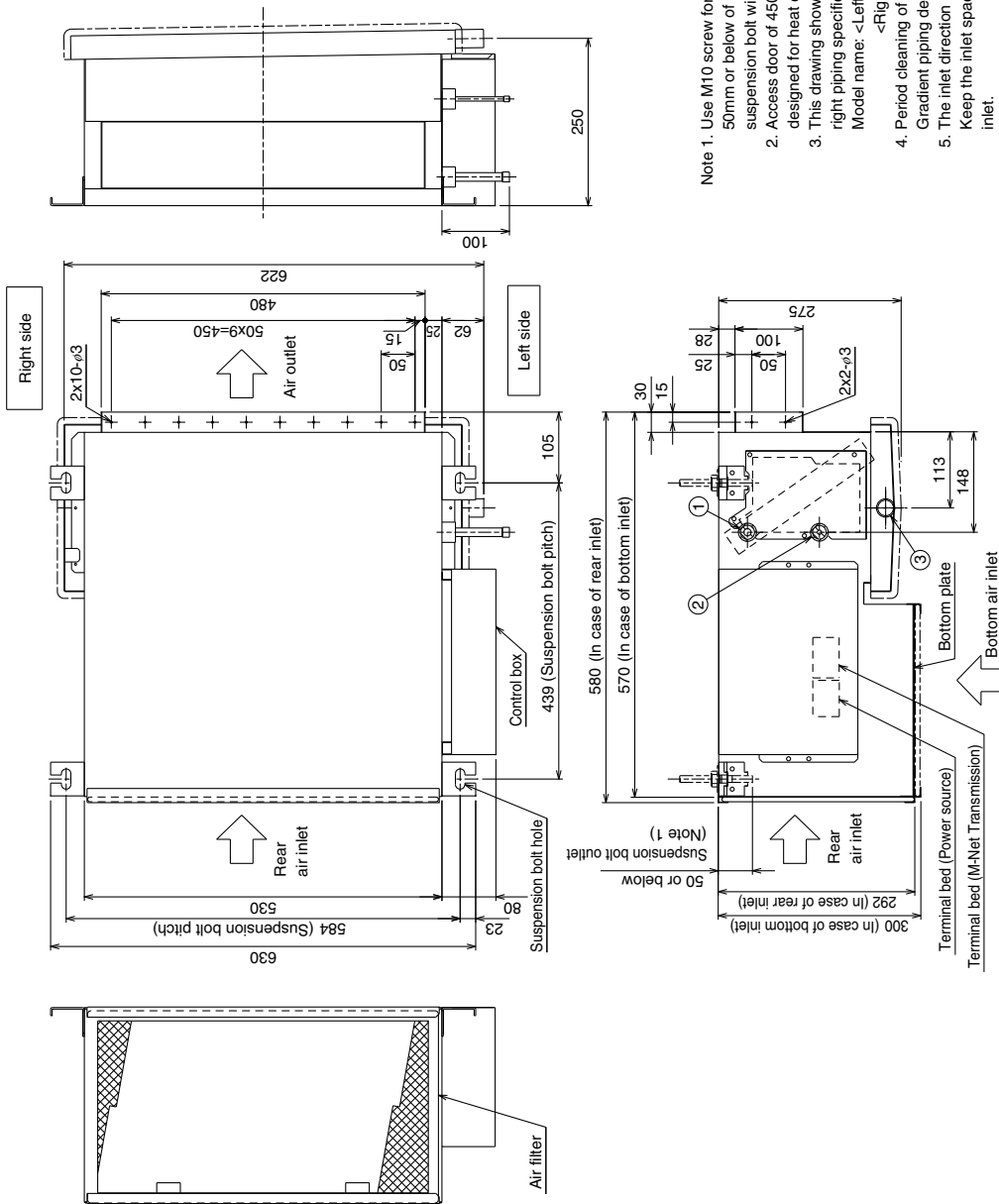

- Note 1.** Use M10 screw for the suspension bolt (field supply).  
50mm or below of clearance between the indoor unit top and the end of the suspension bolt will make maintenance of the indoor heat exchanger easier.
- 2.** Access door of 450mmx450mm at the ceiling under the drain pan should be designed for heat exchanger cleaning and maintenance.
- 3.** This drawing shows the left piping specification. The symmetry shows the right piping specification.  
Model name: <Left piping> PEFY-P20 · 25 · 32VMR-E-L  
<Right piping> PEFY-P20 · 25 · 32VMR-E-R
- 4.** Period cleaning of drain pan will prevent water overflowing.  
Gradient piping design is needed for water draining.
- 5.** The inlet direction can be changed between rear inlet and bottom inlet.  
Keep the inlet space between the ceiling and the unit in case of bottom inlet.

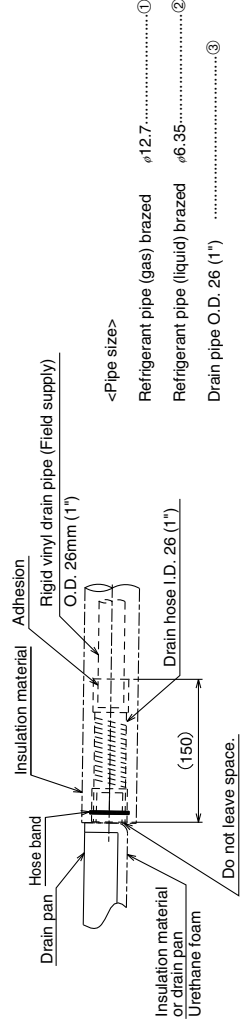

- <Pipe size>
- Refrigerant pipe (gas) brazed  $\phi 12.7$ .....①
  - Refrigerant pipe (liquid) brazed  $\phi 6.35$ .....②
  - Drain pipe O.D. 26 (1") .....③









PEFY-P200, 250VMH-E

Drw. : IU-W27-5925

Unit : mm

- Note : 1. Use M10 screw for the lifting bolt (field supply).  
 2. Keep the service space for the maintenance from the bottom when the heat exchanger is cleaned.  
 3. Make sure to install the air filter (field supply) on the air intake side. In case field supplied air filter is used, attach it where the filter service is easily done.

Model	A	B
P200VMH-E	φ19.05	φ9.52
P250VMH-E	φ22.2	φ9.52

- Refrigerant piping brazing connection  
 (gas A copper tube)   ...①  
 Refrigerant piping brazing connection  
 (liquid B copper tube)   ...②  
 Drain hose I.D. 32 (1-1/4")  
 <flexible joint 200mm>(accessory)   ...③

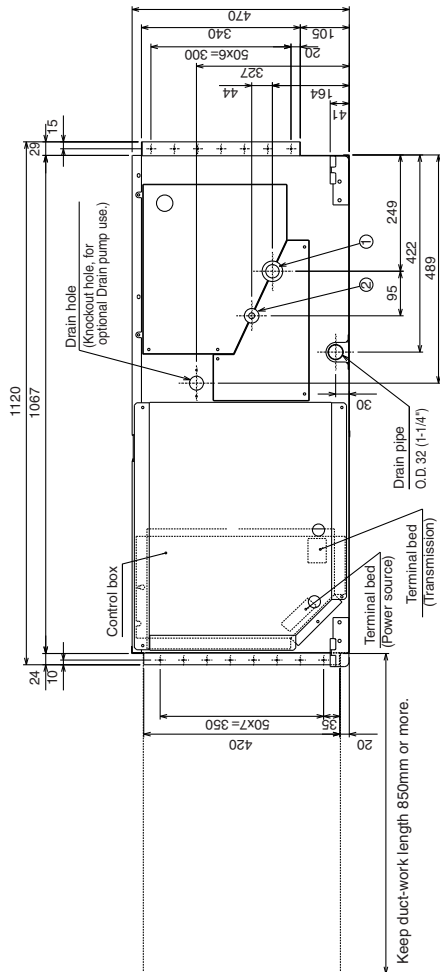
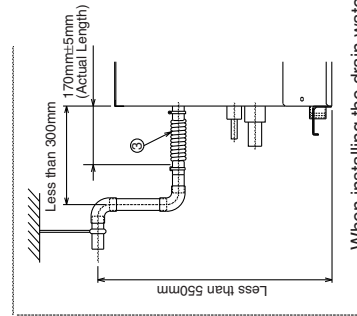
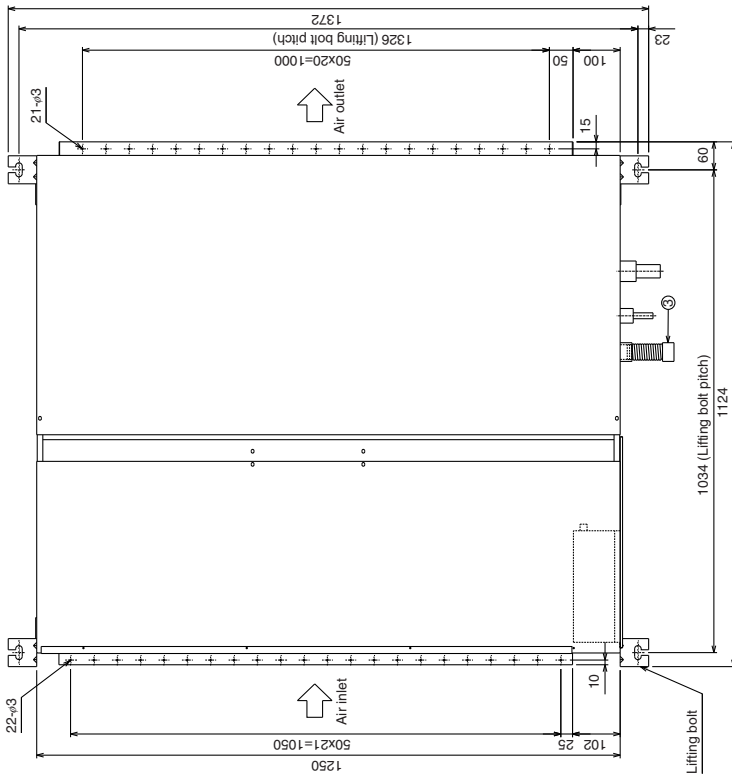
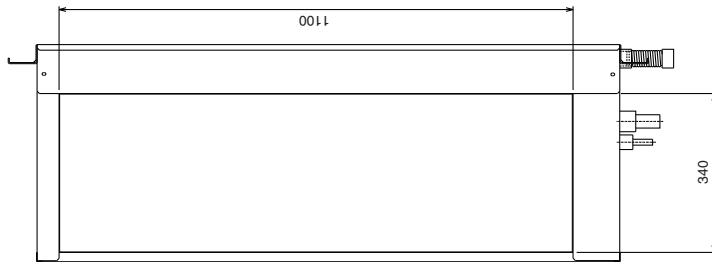

When installing the drain water lifting-up mech(option).

Keep duct-work length 850mm or more.

PEFY-P20, 25, 32VMR-E-L/R

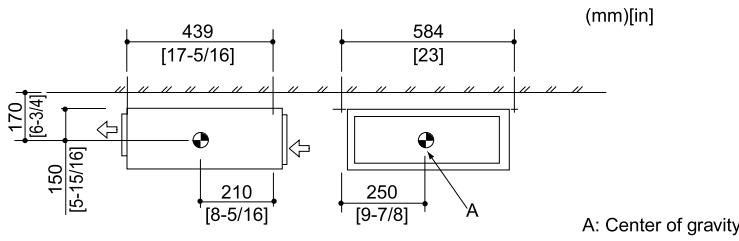

PEFY-P15,20,25,32,40,50,63VMS1(L)-E

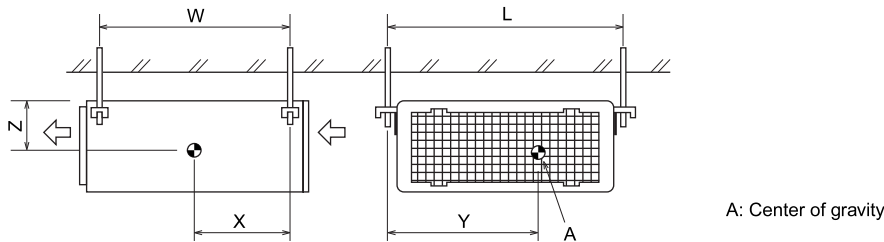

(mm)[in]

Model name	W	L	X	Y	Z
PEFY-P15VMS1(L)-E	625 [24-5/8]	752 [29-5/8]	263 [10-3/8]	338 [13-5/16]	105 [4-5/32]
PEFY-P20VMS1(L)-E	625 [24-5/8]	752 [29-5/8]	263 [10-3/8]	338 [13-5/16]	105 [4-5/32]
PEFY-P25VMS1(L)-E	625 [24-5/8]	752 [29-5/8]	263 [10-3/8]	338 [13-5/16]	105 [4-5/32]
PEFY-P32VMS1(L)-E	625 [24-5/8]	752 [29-5/8]	275 [10-27/32]	340 [13-13/32]	104 [4-1/8]
PEFY-P40VMS1(L)-E	625 [24-5/8]	952 [37-1/2]	280 [11-1/32]	422 [16-5/8]	104 [4-1/8]
PEFY-P50VMS1(L)-E	625 [24-5/8]	952 [37-1/2]	280 [11-1/32]	422 [16-5/8]	104 [4-1/8]
PEFY-P63VMS1(L)-E	625 [24-5/8]	1152 [45-3/8]	285 [11-1/4]	511 [20-1/8]	104 [4-1/8]

PEFY-P40,50,63,71,80,100,125,140,200,250VMH-E

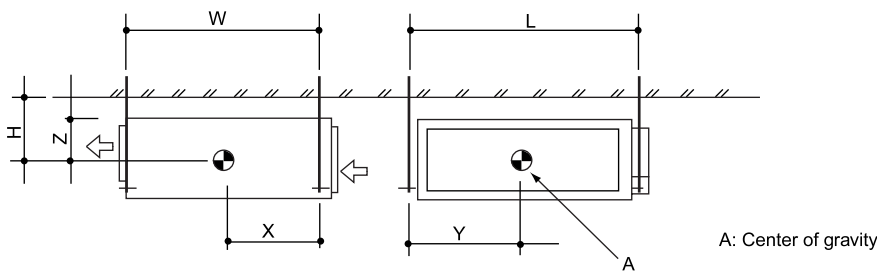

(mm)[in]

Model name	W	L	H	X	Y	Z
PEFY-P40VMH-E	814 [32-1/16]	754 [29-11/16]	210 [8-9/32]	374 [14-3/4]	440 [17-11/32]	190 [7-1/2]
PEFY-P50VMH-E	814 [32-1/16]	754 [29-11/16]	210 [8-9/32]	374 [14-3/4]	440 [17-11/32]	190 [7-1/2]
PEFY-P63VMH-E	814 [32-1/16]	754 [29-11/16]	210 [8-9/32]	374 [14-3/4]	440 [17-11/32]	190 [7-1/2]
PEFY-P71VMH-E	814 [32-1/16]	1004 [39-17/32]	210 [8-9/32]	394 [15-17/32]	584 [22-32/32]	190 [7-1/2]
PEFY-P80VMH-E	814 [32-1/16]	1004 [39-17/32]	210 [8-9/32]	394 [15-17/32]	584 [22-32/32]	190 [7-1/2]
PEFY-P100VMH-E	814 [32-1/16]	1204 [47-13/32]	210 [8-9/32]	364 [14-11/32]	649 [25-9/16]	190 [7-1/2]
PEFY-P125VMH-E	814 [32-1/16]	1204 [47-13/32]	210 [8-9/32]	364 [14-11/32]	649 [25-9/16]	190 [7-1/2]
PEFY-P140VMH-E	814 [32-1/16]	1204 [47-13/32]	210 [8-9/32]	364 [14-11/32]	649 [25-9/16]	190 [7-1/2]
PEFY-P200VMH-E	1034 [40-23/32]	1326 [52-7/32]	255 [10-1/16]	462 [18-7/32]	660 [25-32/32]	235 [9-9/32]
PEFY-P250VMH-E	1034 [40-23/32]	1326 [52-7/32]	255 [10-1/16]	462 [18-7/32]	660 [25-32/32]	235 [9-9/32]

PEFY-P20,25,32VMR-E-L/R

Drw. : IU-KB94-C858

INSIDE SECTION OF CONTROL BOX

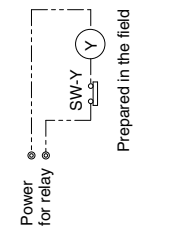
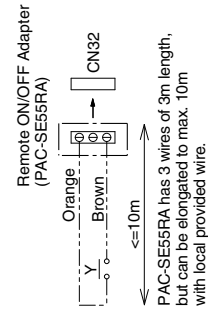
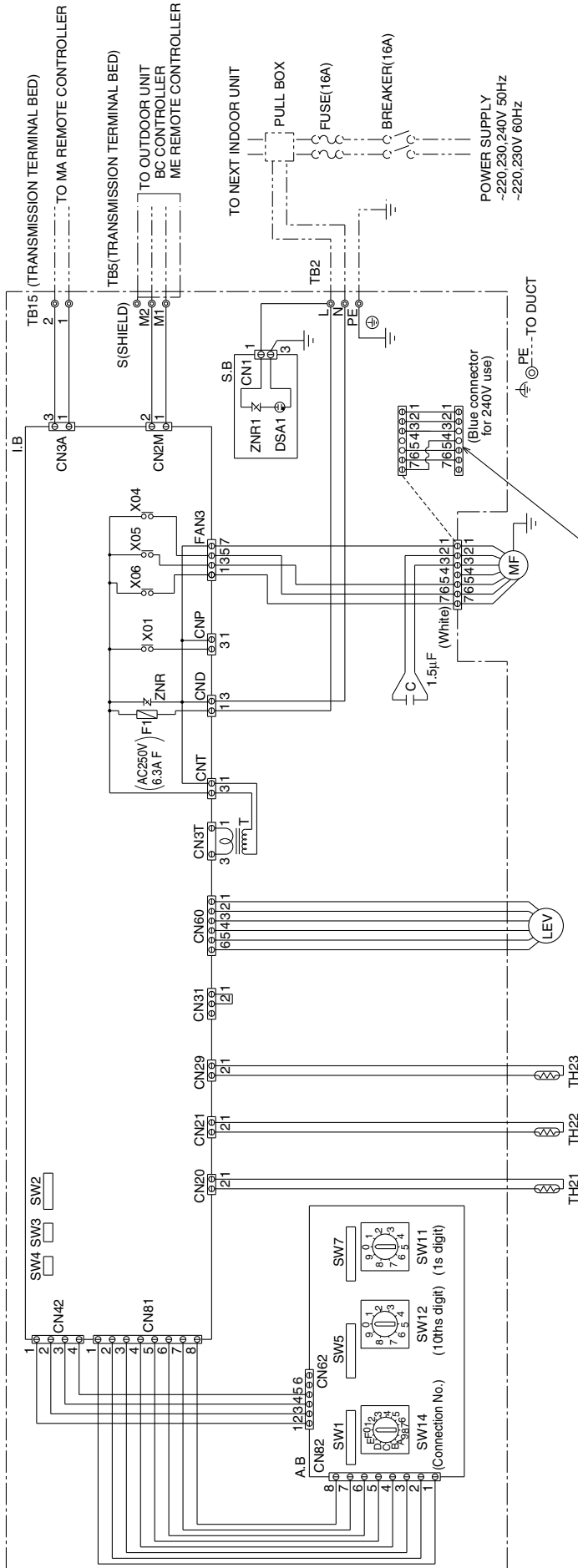

At factory shipment, the motor connector is connected for 220-230V power. If 240V power is used, insert the attached Blue connector between the Motor connector and White connector from Indoor board.  
 Connector color: for power source  
 White: 220V,230V  
 Blue: 240V

SW-Y	Status	Display and operation at Local Remote Controller
OFF	Obey to local remote controller (Allowed)	Operation permitted
ON	Remote - OFF	"Central control" displayed. Local Remote Controller operation prohibited (not functioning)

Y: Aux. relay (Load >= 12VDC 1mA)

NOTE: 1. The wirings to TB2, TB5 shown in dotted line are field work.  
 2. Mark ⊕ indicates terminal bed, ⊙ connector, ⊠ board insertion connector or fastening connector of control board.

SYMBOL EXPLANATION

SYMBOL	NAME	SYMBOL	NAME
MF	Fan motor	TH21	Thermistor (inlet temp. detection)
C	Capacitor (for MF)	TH22	Thermistor (piping temp. detection/liquid)
I.B	Indoor controller board	TH23	Thermistor (piping temp. detection/gas)
A.B	Address board	SW11(A,B)	Switch (1s digit address set)
TB2	Power source terminal bed	SW12(A,B)	Switch (10ths digit address set)
TB5	Transmission terminal bed	SW14(A,B)	Switch (connection No. set)
TB15	Transmission terminal bed	SW1(A,B)	Switch (for mode selection)
F1	Fuse AC250V 6.3A F	SW2(I,B)	Switch (for capacity code)
T	Transformer	SW3(I,B)	Switch (for model selection)
LEV	Electronic linear expans. valve	SW4(I,B)	Switch (for model selection)
S.B	Surge absorber board	SW5(A,B)	Switch (for voltage selection)
X04~X06	Aux. relay	SW7(A,B)	Switch (for mode selection)

PEFY-P15,20,25,32,40,50,63VMS1(L)-E

Drw. : IU-KB94-G668

INSIDE SECTION OF CONTROL BOX

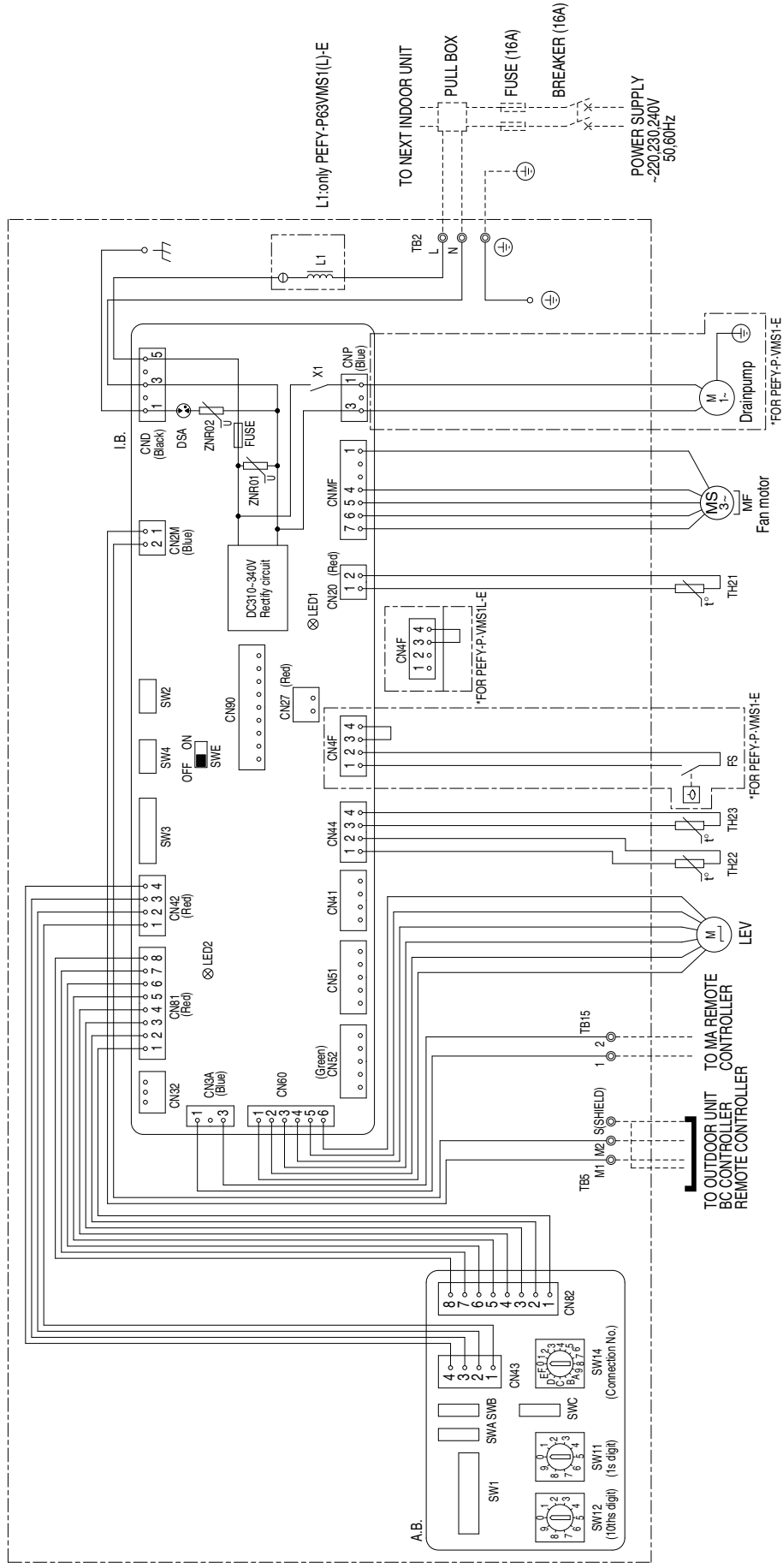

SYMBOL EXPLANATION

SYMBOL	NAME	SYMBOL	NAME	SYMBOL	NAME
I.B.	Indoor controller board	SW4(L.B.)	Switch (for model selection)		
A.B.	Address board	SWE(L.B.)	Connector (emergency operation)		
TB2	Power source terminal bed	SW1(A.B.)	Switch (for mode selection)		
TB5	Transmission terminal bed	SW11(A.B.)	Switch (1s digit address set)		
TB15	Transmission terminal bed	SW12(A.B.)	Switch (10ths digit address set)		
FUSE	Fuse AC250V 6.3A	SW14(A.B.)	Switch (connection No.set)		
ZNR01.02	Varistor	SWA(A.B.)	Switch (for static pressure selection)		
DSA	Arrester	SWB(A.B.)	Switch (for model selection)		
X1	Aux. relay	SWC(A.B.)	Switch (for static pressure selection)		
L1	AC reactor (Power factor improvement)	SW2(L.B.)	Switch (for capacity code)		
CN87	Connector (Damper)	SW3(L.B.)	Switch (for mode selection)		

NOTE:1. The wirings to TB2, TB5, TB15 shown in dotted line are field work.  
2. Mark ⊕ indicates terminal bed, ⊕ connector.

PEFY-P40,50,63,71,80,100,125,140VMH-E

Draw. : IU-W65-3956

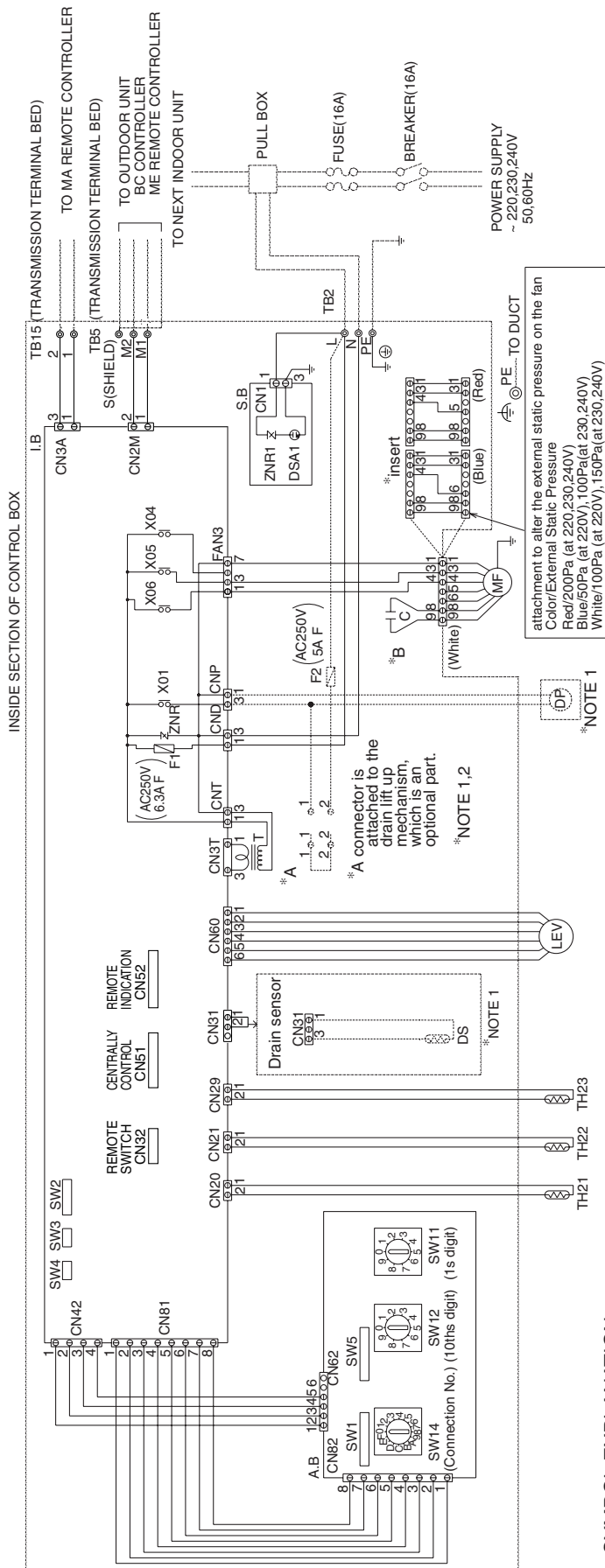

NOTE : 1. The part of the broken line indicates the circuit for optional parts.  
 2. \*A in the chart is the connector for a drain pump test run operation.  
 (The Drain Pump operates continuously if the connector is inserted and the power is supplied.)  
 After the test run, make sure to remove the \*A connector.  
 3. The wirings to TB2, TB5 (shown in dotted line) are field work.  
 4. Mark (C) indicates terminal bed, (R) connector, (S) board insertion connector or fastening connector of control board.

SYMBOL EXPLANATION

SYMBOL	NAME	SYMBOL	NAME
MF	Fan motor	S.B	Surge absorber board
C	*B Capacitor (for MF)	TH21	Thermistor (inlet temp.detection)
I.B	Indoor controller board	TH22	Thermistor (piping temp.detection/liquid)
A.B	Address board	TH23	Thermistor (piping temp.detection/gas)
TB2	Power source terminal bed	SW11(A,B)	Switch (1s digit address set)
TB5	Transmission terminal bed	SW12(A,B)	Switch (10ths digit address set)
TB15	Transmission terminal bed	SW14(A,B)	Switch (connection No.set)
F1	Fuse AC250V 6.3A F	SW11(A,B)	Switch(for mode selection)
<F2>	Fuse AC250V 5A F	SW2(L,B)	Switch(for capacity code)
T	Transformer	SW3(L,B)	Switch(for mode selection)
<DP>	Drain Pump	SW4(L,B)	Switch(for model selection)
LEV	Electronic linear expans. valve	SW5(A,B)	Switch(for voltage selection)
<DS>	Drain sensor	X04-X06	Aux. relay

inside < > is the optional parts

\*B Capacitor  
 MODELS 40/50 3.0μF  
 MODEL 63 4.0μF  
 MODELS 71/80 5.0μF  
 MODELS 100/125/140 7.0μF

\*A connector is attached to the drain lift up mechanism, which is an optional part.  
 \*NOTE 1.2

attachment to alter the external static pressure on the fan  
 Color/External Static Pressure  
 Red/200Pa (at 220,230,240V)  
 Blue/50Pa (at 220V), 100Pa(at 230,240V)  
 White/100Pa (at 220V), 150Pa(at 230,240V)



PEFY-P200,250VMH-E

Drw. : IU-W65-3957

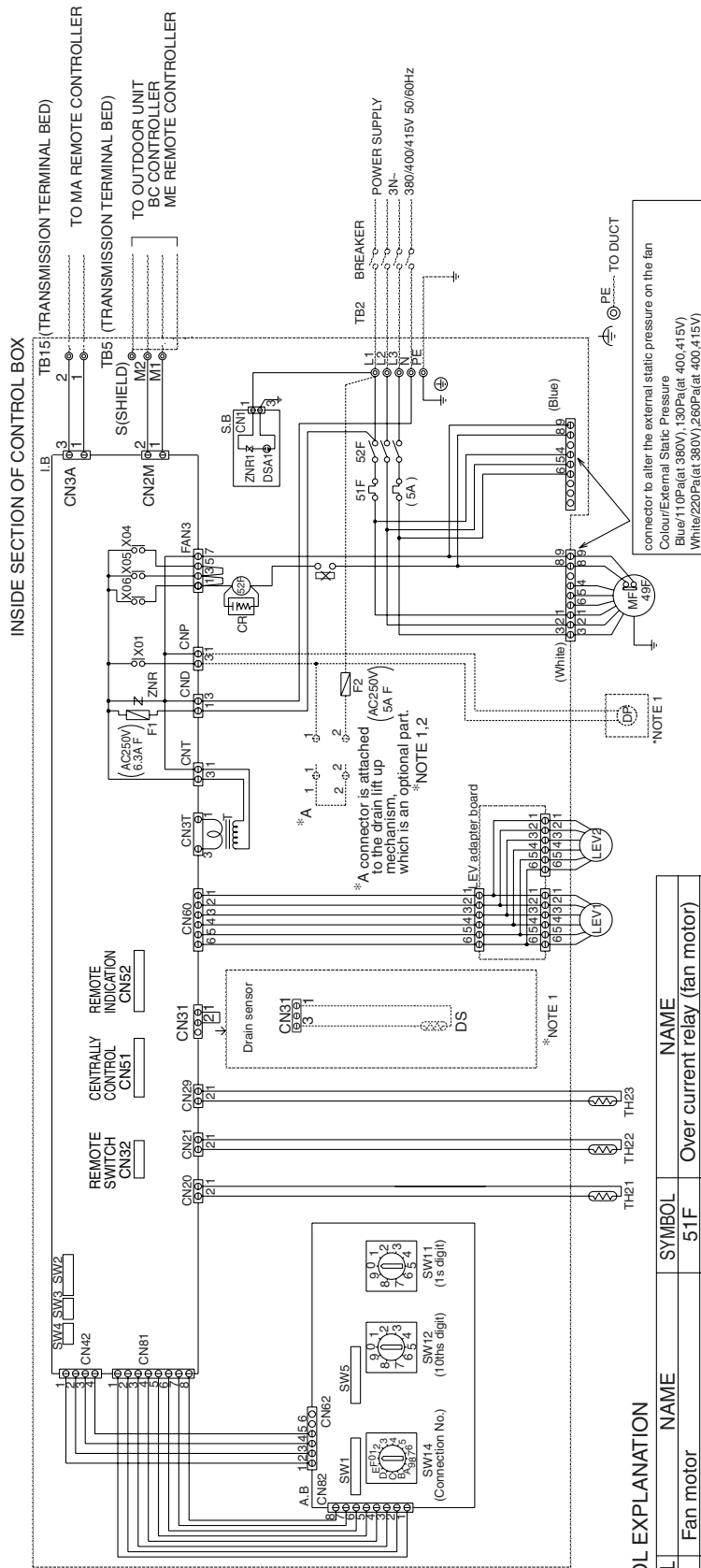

CAUTION : 1. To protect Fan motor from abnormal current, Over current relays-51F-> is installed. Therefore, do not change factory set value of Over current relays.

- NOTE : 1. The part of the broken line indicates the circuit for optional parts.  
 2. 'A' in the chart is the connector for a drain pump test run operation. (The Drain Pump operates continuously if the connector is inserted and the power is supplied.)  
 After the test run, make sure to remove the 'A' connector.  
 3. The wirings to TB2, TB5 shown in dotted line are field work.  
 4. Mark ⊙ indicates terminal bed, ⊕ connector, ⊞ board insertion connector or fastening connector of control board.

SYMBOL EXPLANATION

SYMBOL	NAME	SYMBOL	NAME
MF	Fan motor	51F	Over current relay (fan motor)
I.B	Indoor controller board	TH21	Thermistor (inlet temp.detection)
A.B	Address board	TH22	Thermistor (piping temp.detection/liquid)
TB2	Power source terminal bed	TH23	Thermistor (piping temp.detection/gas)
TB5	Transmission terminal bed	SW11(A.B)	Switch (1s digit address set)
TB15	Transmission terminal bed	SW12(A.B)	Switch (10ths digit address set)
F-1	Fuse AC250V 6.3A F	SW14(A.B)	Switch (connection No.set)
<F2>	Fuse AC250V 5A F	SW1(A.B)	Switch (for mode selection)
T	Transformer	SW2(L.B)	Switch (for capacity code)
<DP>	Drain Pump	SW3(L.B)	Switch (for mode selection)
LEV1,LEV2	Electronic linear expan. valve	SW4(L.B)	Switch (for model selection)
<DS>	Drain sensor	SW5(A.B)	Switch (for voltage selection)
S.B	Surge absorber board	X04-X06	Aux. relay
52F	Contactora (fan motor)	49F	Inner thermostat

inside < > is the optional parts

# 5. SOUND LEVELS

## 5-1. Sound levels

PEFY

PEFY-P-VMR-E-L/R, VMS1(L)-E, VMH-E

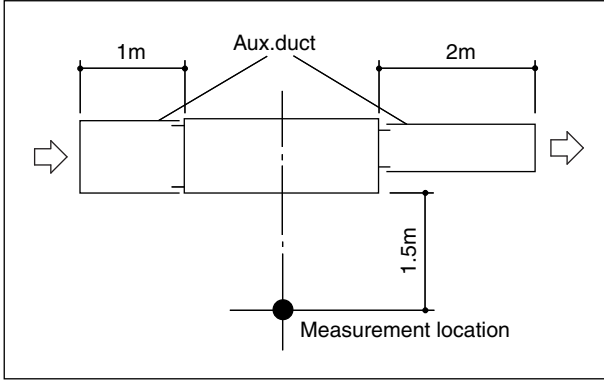

\* Measured in anechoic room.

Sound level at anechoic room : Low-Mid-High

		Sound level dB (A)	
PEFY-P20VMR-E-L/R	220V	20-25-30	
	230V	21-26-32	
	240V	22-27-30	
PEFY-P25VMR-E-L/R	220V	20-25-30	
	230V	21-26-32	
	240V	22-27-30	
PEFY-P32VMR-E-L/R	220V	20-25-33	
	230V	21-26-35	
	240V	22-27-33	

Sound level at anechoic room : Low-Mid-High

		Sound level dB (A)			
		5Pa	15Pa	35Pa	50Pa
PEFY-P15VMS1(L)-E	220-240V	22-24-26	22-24-28	23-26-29	23-27-30
PEFY-P20VMS1(L)-E	220-240V	22-25-28	23-25-29	24-27-30	25-28-32
PEFY-P25VMS1(L)-E	220-240V	22-25-29	23-26-30	24-28-31	25-29-33
PEFY-P32VMS1(L)-E	220-240V	23-27-30	23-27-32	24-28-33	25-29-34
PEFY-P40VMS1(L)-E	220-240V	26-28-30	28-30-33	30-32-35	31-33-36
PEFY-P50VMS1(L)-E	220-240V	29-31-34	30-32-35	31-34-37	32-34-38
PEFY-P63VMS1(L)-E	220-240V	29-32-35	30-33-36	31-35-39	32-36-40

Sound level at anechoic room : Low-High

		Sound level dB (A)		
		Low*	Mid*	High*
PEFY-P40VMH-E	220V	25-30	27-34	30-40
PEFY-P50VMH-E	230, 240V	30-34	31-37	31-41
PEFY-P63VMH-E	220V	31-36	32-38	36-43
	230, 240V	35-39	36-41	38-44
PEFY-P71VMH-E	220V	30-36	32-39	35-43
	230, 240V	34-39	35-41	37-44
PEFY-P80VMH-E	220V	32-39	35-41	37-43
PEFY-P80VMH-E	230, 240V	37-41	38-43	39-45
	220V	32-40	34-42	36-46
PEFY-P100,125VMH-E	220V	32-40	34-42	36-46
PEFY-P140VMH-E	230, 240V	36-42	38-44	38-47
PEFY-P200VMH-E	380V	42	-	45
	400, 415V	44	-	47
PEFY-P250VMH-E	380V	50	-	52
	400, 415V	52	-	54

\* External static pressure of PEFY-P40-140VMH-E  
 Low : 50Pa at 220V, 100Pa at 230, 240V  
 Mid : 100Pa at 220V, 150Pa at 230, 240V  
 High : 200Pa at 220V, 200Pa at 230, 240V

\* External static pressure of PEFY-P200-250VMH-E  
 Low : 110Pa at 380V, 130Pa at 400,415V  
 High : 220Pa at 380V, 260Pa at 400,415V

5-2. NC curves

PEFY

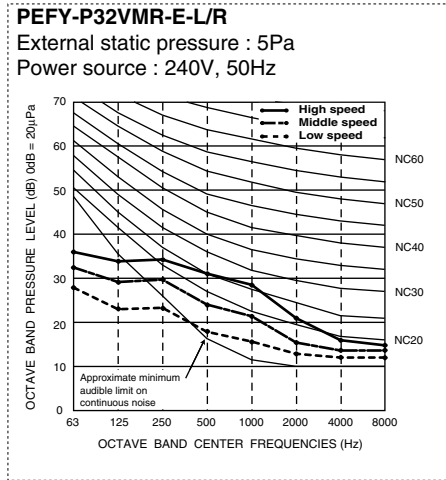
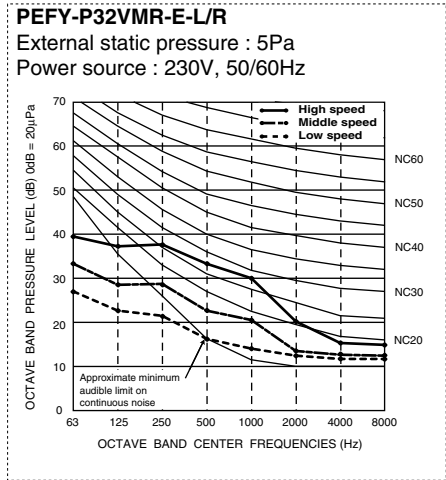
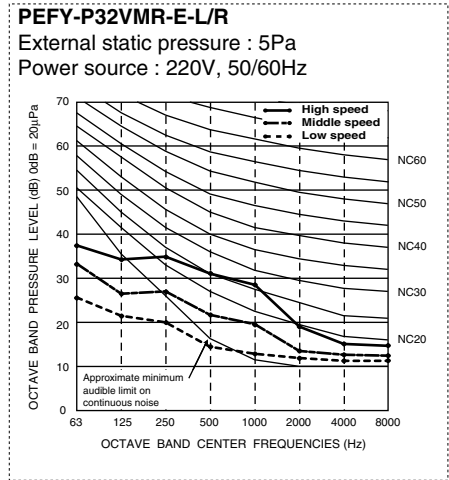
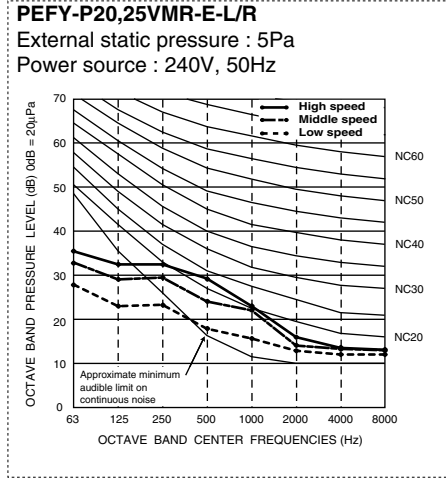
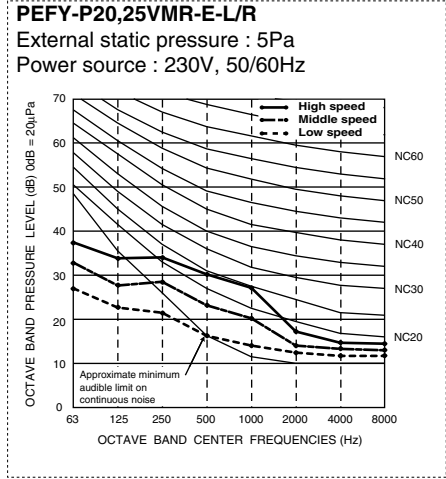
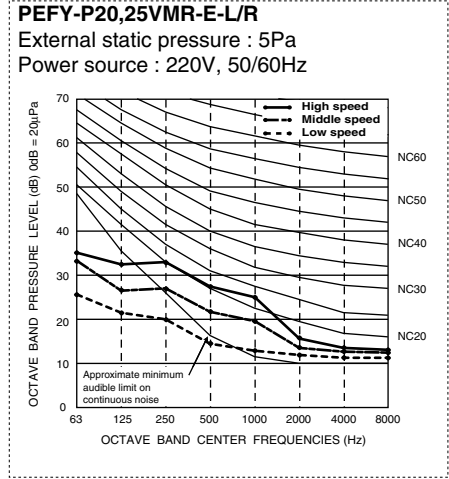

## 5-2. NC curves

PEFY

### PEFY-P15VMS1(L)-E

External static pressure : 5Pa  
Power source : 220,230,240V, 50/60Hz

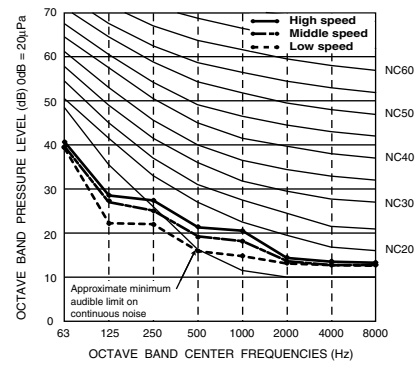

### PEFY-P15VMS1(L)-E

External static pressure : 15Pa  
Power source : 220,230,240V, 50/60Hz

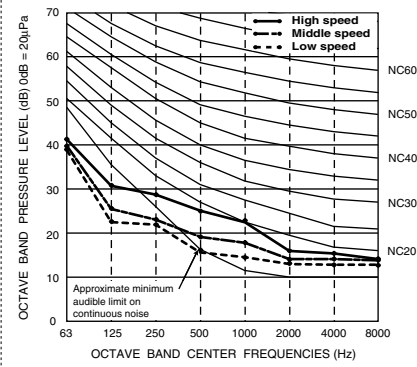

### PEFY-P15VMS1(L)-E

External static pressure : 35Pa  
Power source : 220,230,240V, 50/60Hz

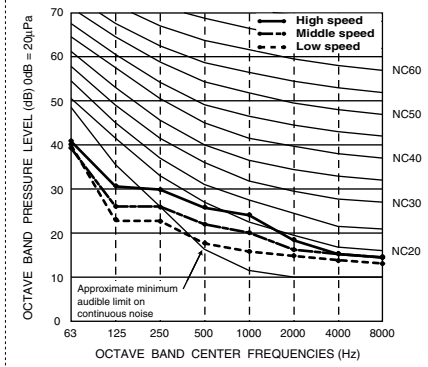

### PEFY-P15VMS1(L)-E

External static pressure : 50Pa  
Power source : 220,230,240V, 50/60Hz

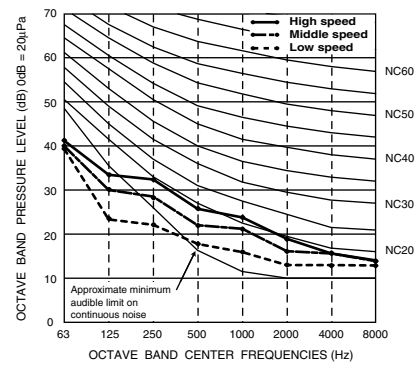

### PEFY-P20VMS1(L)-E

External static pressure : 5Pa  
Power source : 220,230,240V, 50/60Hz

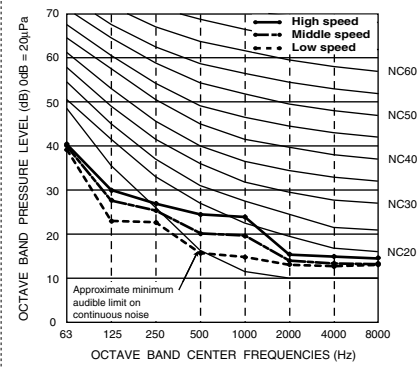

### PEFY-P20VMS1(L)-E

External static pressure : 15Pa  
Power source : 220,230,240V, 50/60Hz

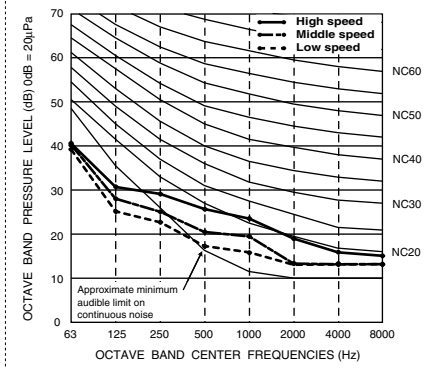

### PEFY-P20VMS1(L)-E

External static pressure : 35Pa  
Power source : 220,230,240V, 50/60Hz

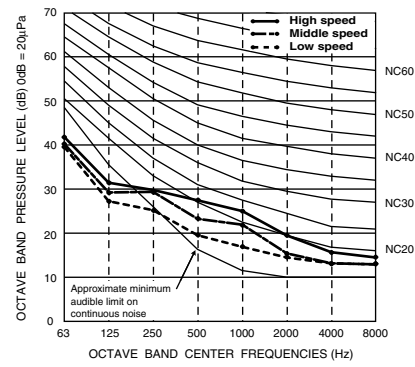

### PEFY-P20VMS1(L)-E

External static pressure : 50Pa  
Power source : 220,230,240V, 50/60Hz

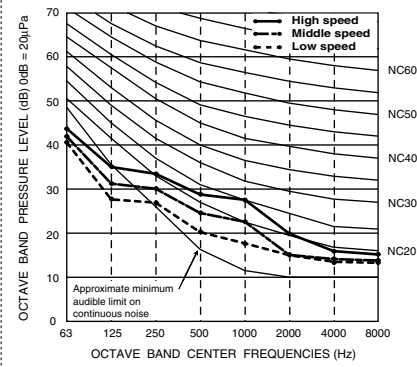

### PEFY-P25VMS1(L)-E

External static pressure : 5Pa  
Power source : 220,230,240V, 50/60Hz

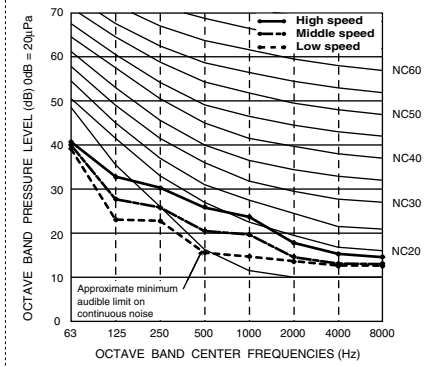

### PEFY-P25VMS1(L)-E

External static pressure : 15Pa  
Power source : 220,230,240V, 50/60Hz

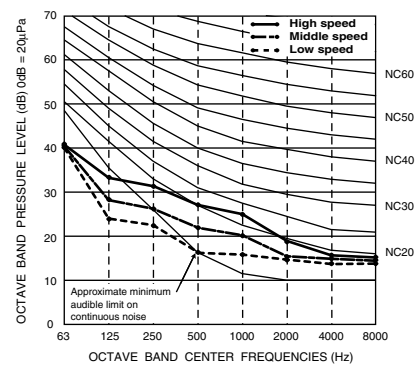

### PEFY-P25VMS1(L)-E

External static pressure : 35Pa  
Power source : 220,230,240V, 50/60Hz

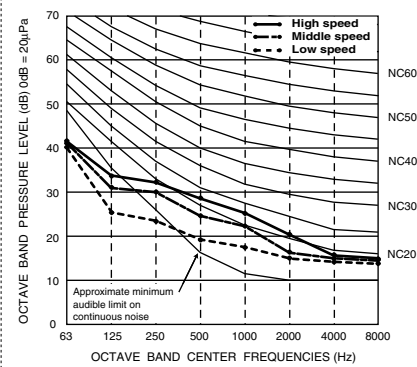

### PEFY-P25VMS1(L)-E

External static pressure : 50Pa  
Power source : 220,230,240V, 50/60Hz

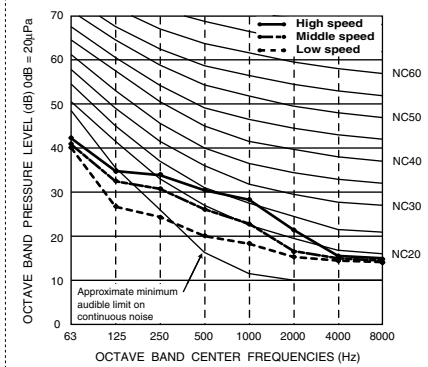

5-2. NC curves

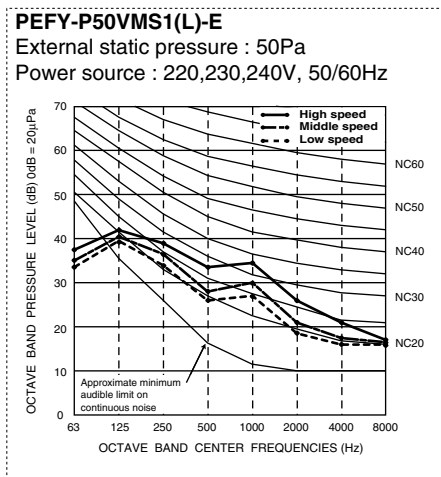
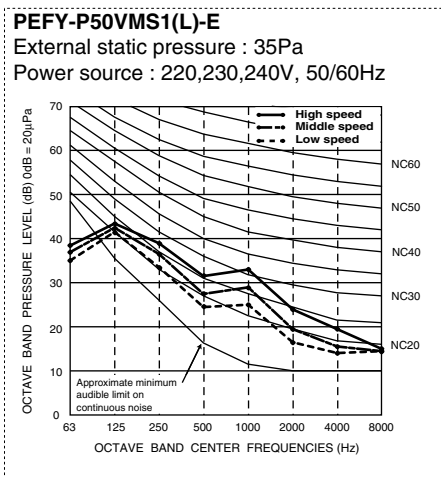
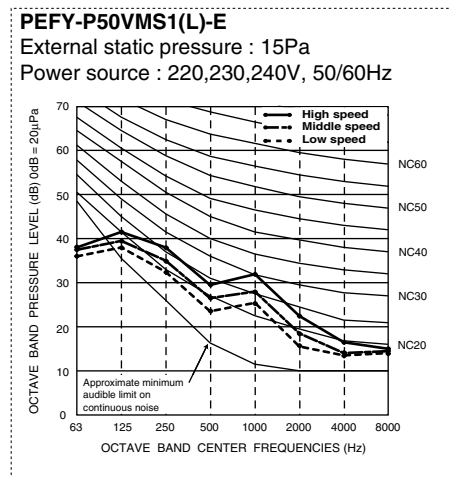
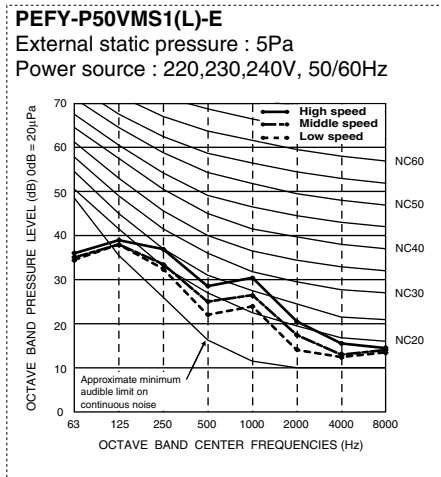
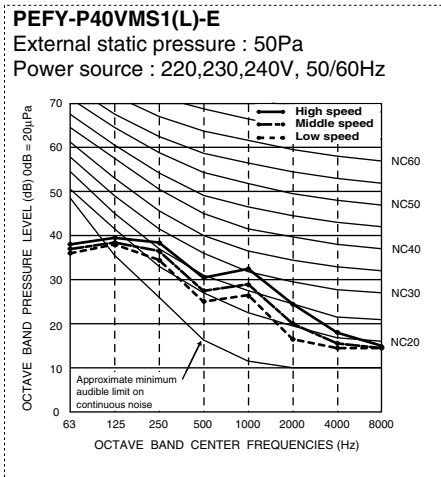
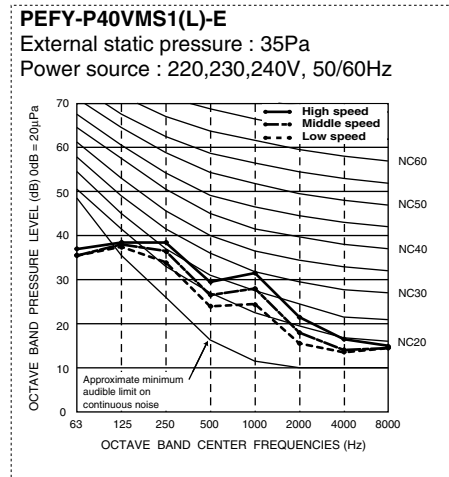
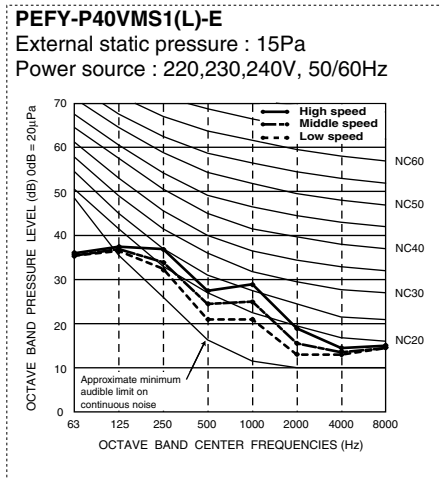
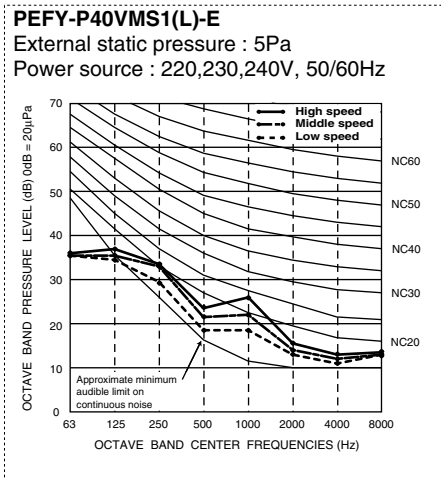
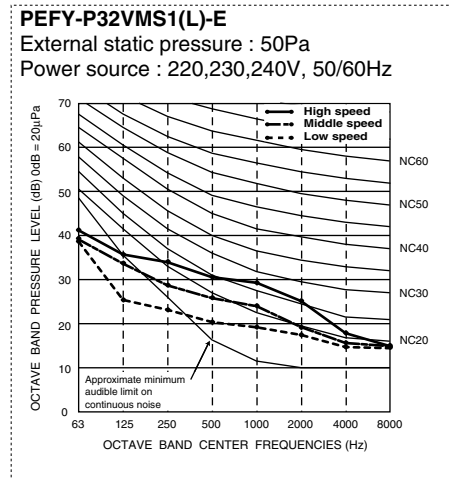
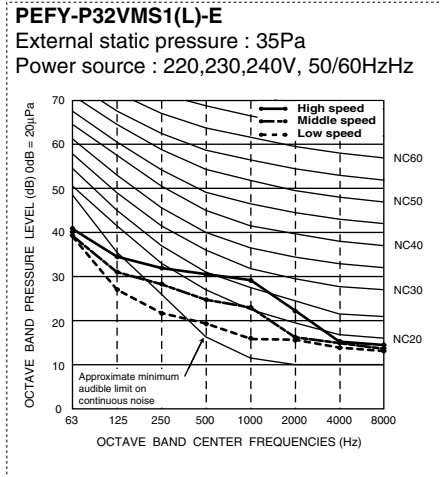
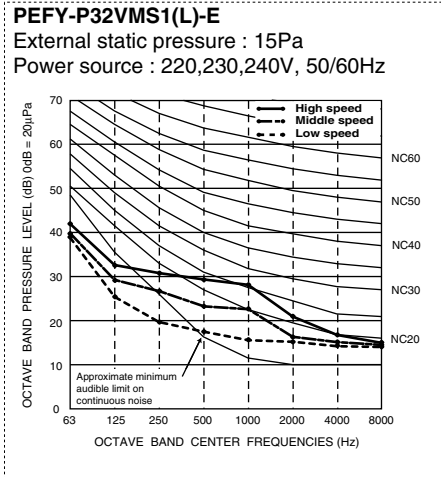
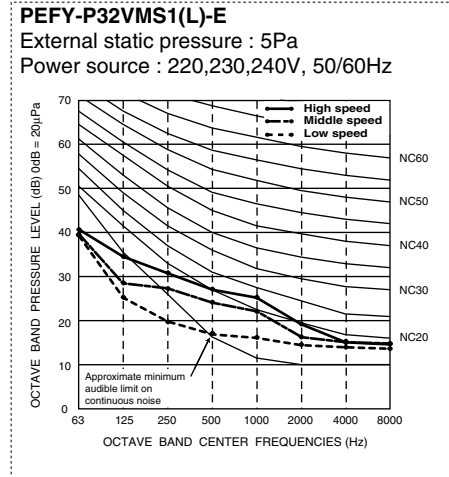

PEFY



## 5-2. NC curves

PEFY

### PEFY-P63VMS1(L)-E

External static pressure : 5Pa  
Power source : 220,230,240V, 50/60Hz

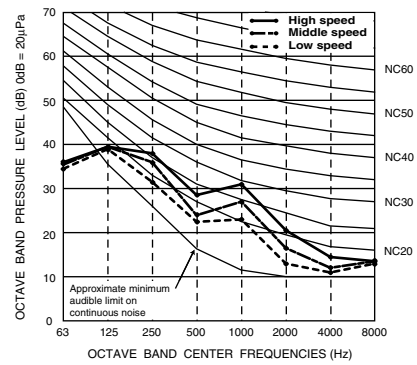

### PEFY-P63VMS1(L)-E

External static pressure : 15Pa  
Power source : 220,230,240V, 50/60Hz

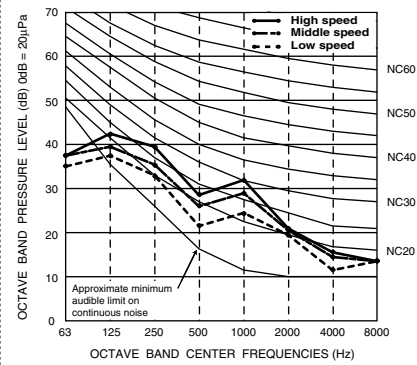

### PEFY-P63VMS1(L)-E

External static pressure : 35Pa  
Power source : 220,230,240V, 50/60Hz

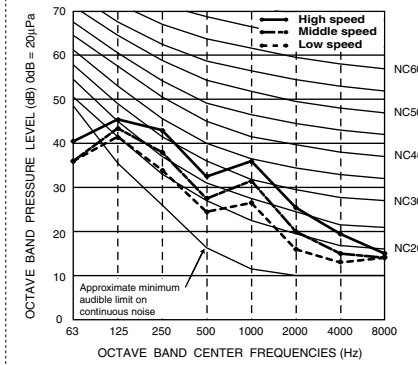

### PEFY-P63VMS1(L)-E

External static pressure : 50Pa  
Power source : 220,230,240V, 50/60Hz

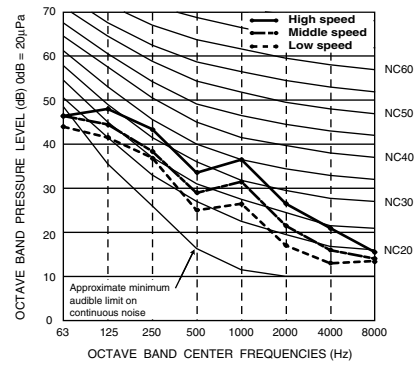

### PEFY-P40,50VMH-E

External static pressure : 100Pa  
Power source : 220V, 50/60Hz

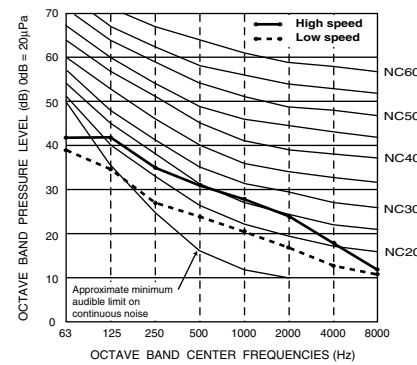

### PEFY-P40,50VMH-E

External static pressure : 200Pa  
Power source : 220V, 50/60Hz

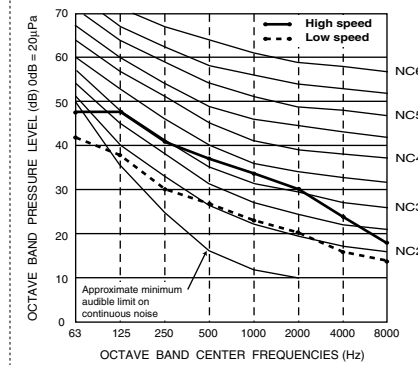

### PEFY-P63VMH-E

External static pressure : 50Pa  
Power source : 220V, 50/60Hz

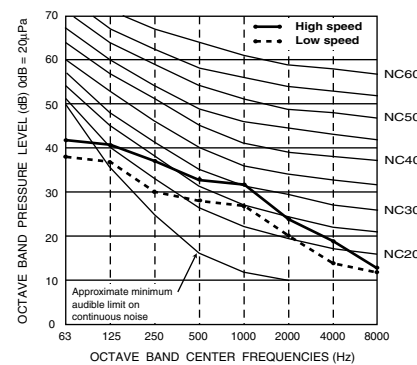

### PEFY-P63VMH-E

External static pressure : 100Pa  
Power source : 220V, 50/60Hz

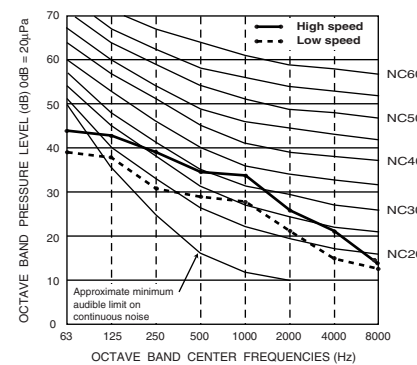

### PEFY-P63VMH-E

External static pressure : 200Pa  
Power source : 220V, 50/60Hz

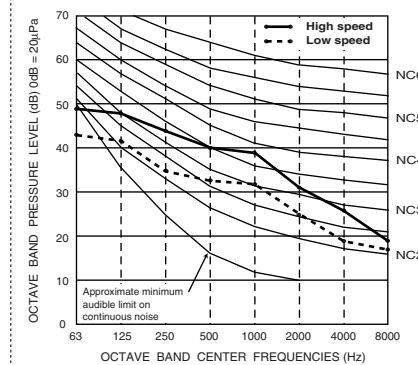

## 5-2. NC curves

PEFY

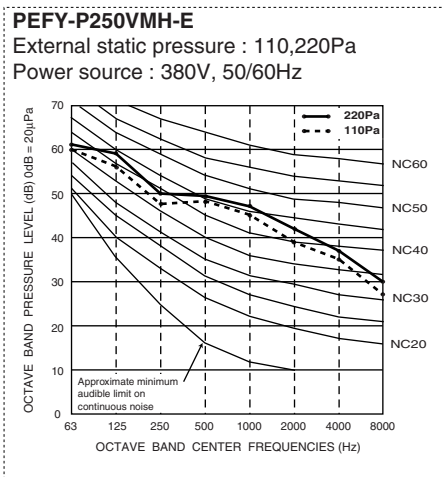
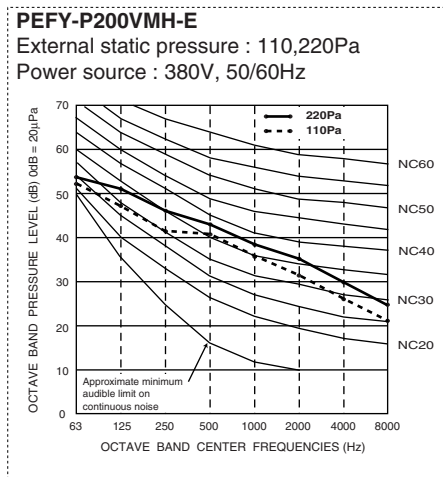
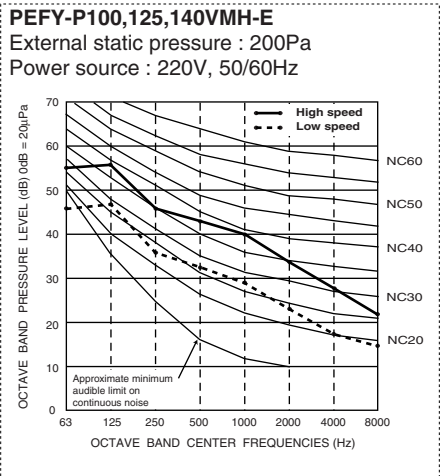
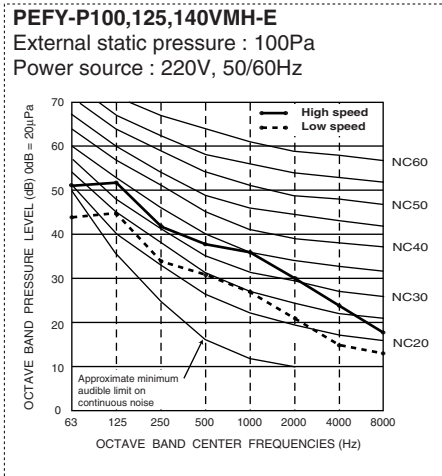
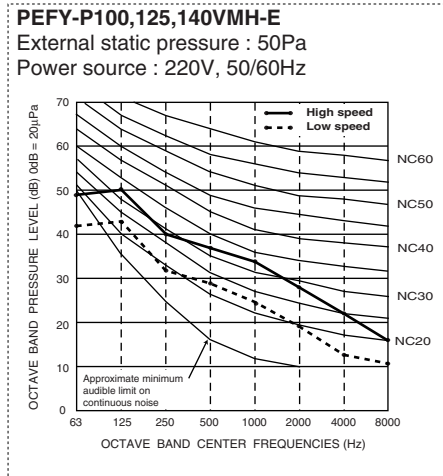
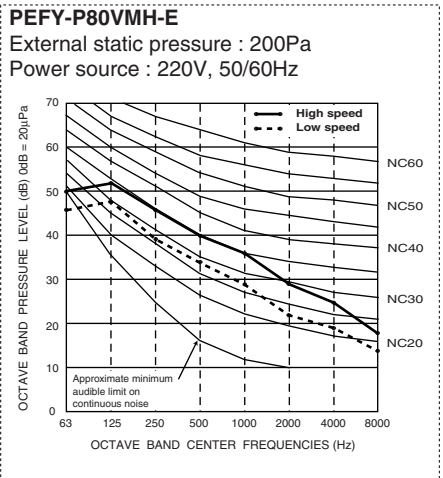
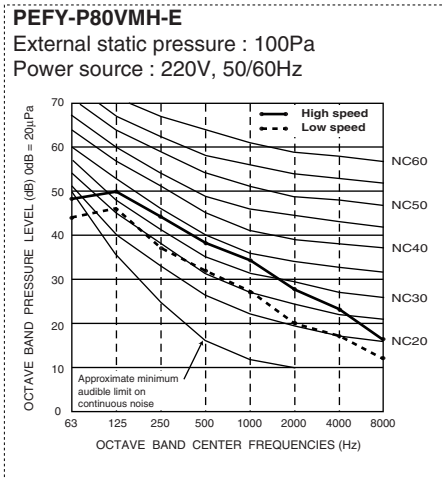
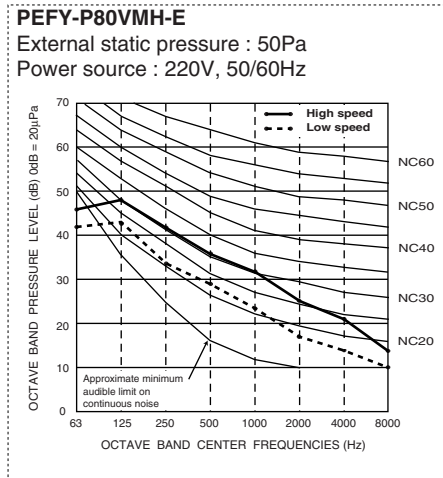
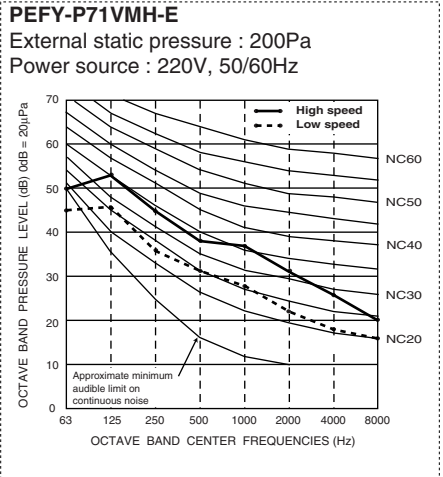
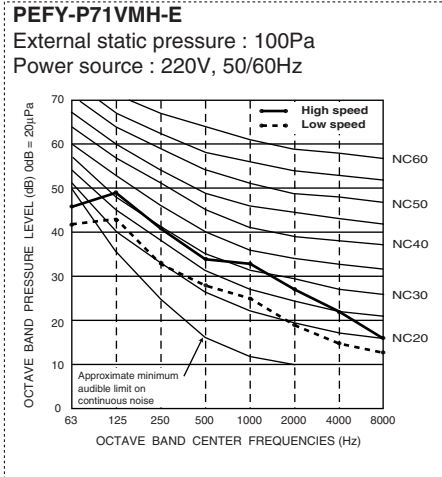
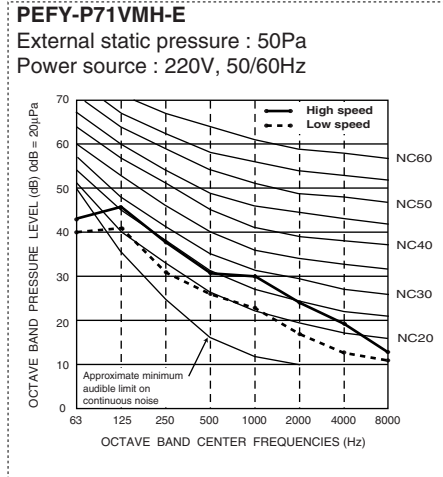

## 5-2. NC curves

PEFY

### PEFY-P40,50VMH-E

External static pressure : 100Pa  
Power source : 230,240V, 50/60Hz

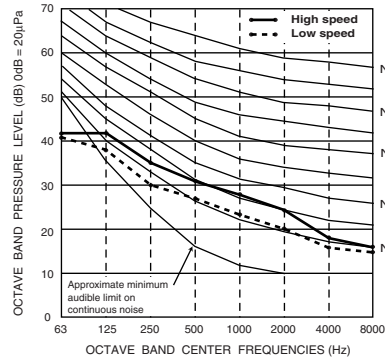

### PEFY-P40,50VMH-E

External static pressure : 150Pa  
Power source : 230,240V, 50/60Hz

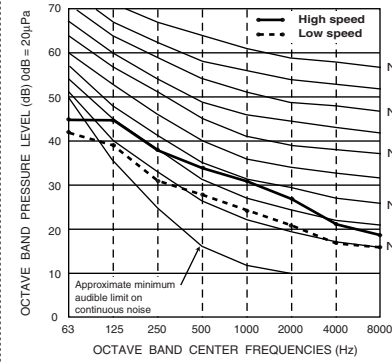

### PEFY-P40,50VMH-E

External static pressure : 200Pa  
Power source : 230,240V, 50/60Hz

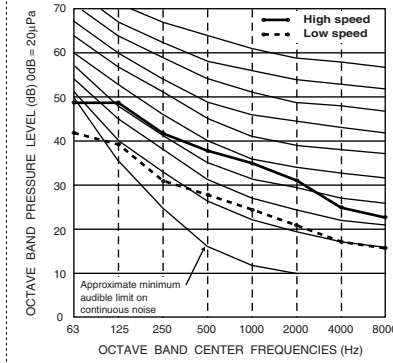

### PEFY-P63VMH-E

External static pressure : 100Pa  
Power source : 230,240V, 50/60Hz

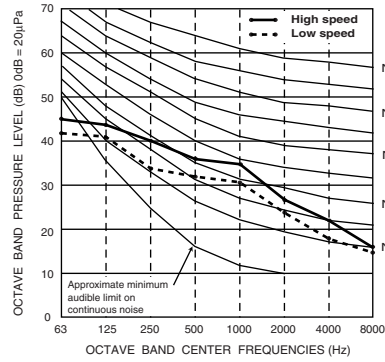

### PEFY-P63VMH-E

External static pressure : 150Pa  
Power source : 230,240V, 50/60Hz

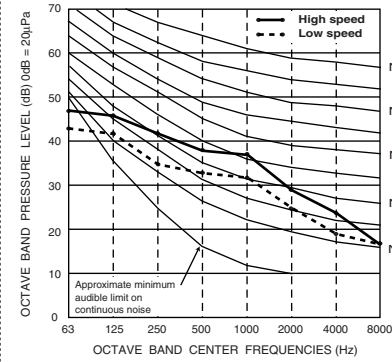

### PEFY-P63VMH-E

External static pressure : 200Pa  
Power source : 230,240V, 50/60Hz

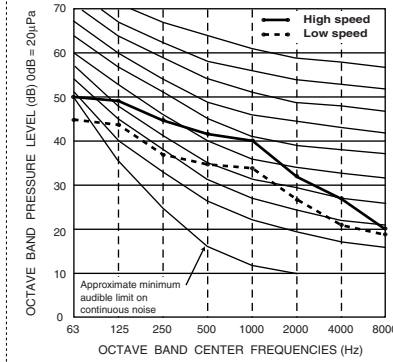

### PEFY-P71VMH-E

External static pressure : 100Pa  
Power source : 230,240V, 50/60Hz

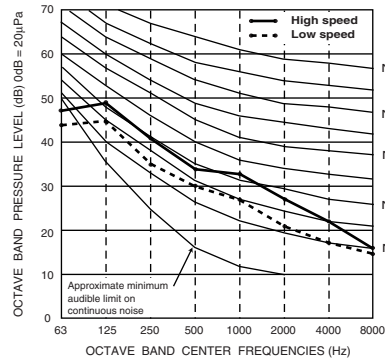

### PEFY-P71VMH-E

External static pressure : 150Pa  
Power source : 230,240V, 50/60Hz

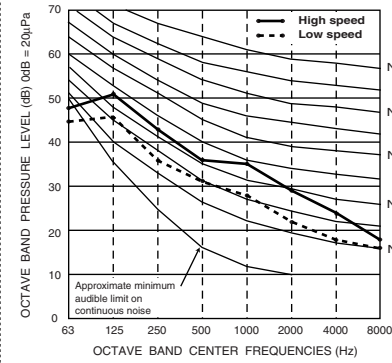

### PEFY-P71VMH-E

External static pressure : 200Pa  
Power source : 230,240V, 50/60Hz

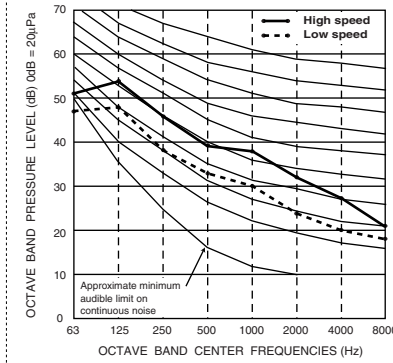

### PEFY-P80VMH-E

External static pressure : 100Pa  
Power source : 230,240V, 50/60Hz

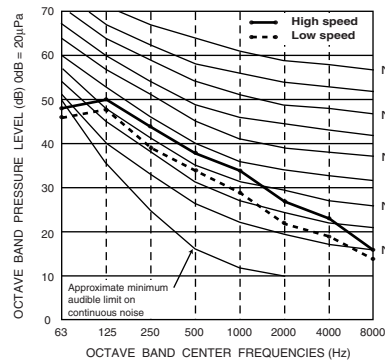

### PEFY-P80VMH-E

External static pressure : 150Pa  
Power source : 230,240V, 50/60Hz

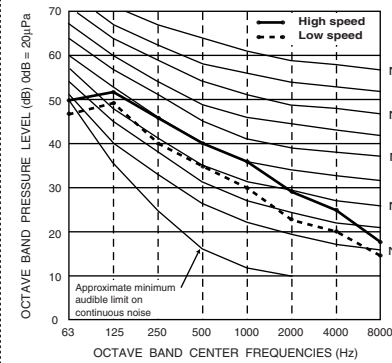

### PEFY-P80VMH-E

External static pressure : 200Pa  
Power source : 230,240V, 50/60Hz

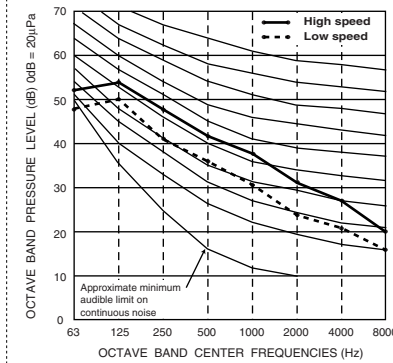



## 5-2. NC curves

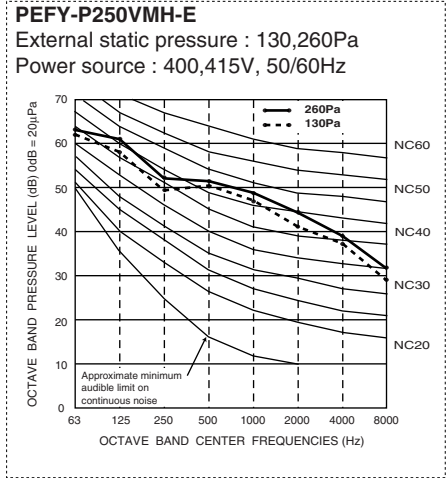
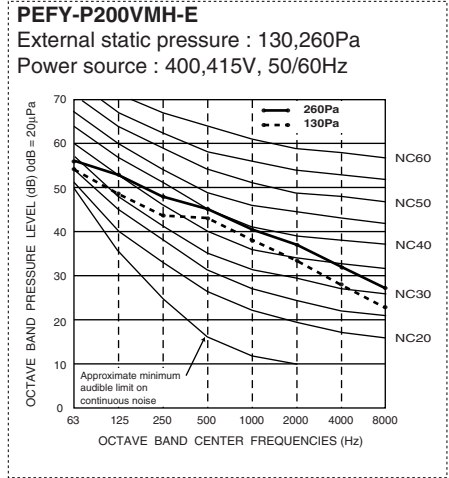
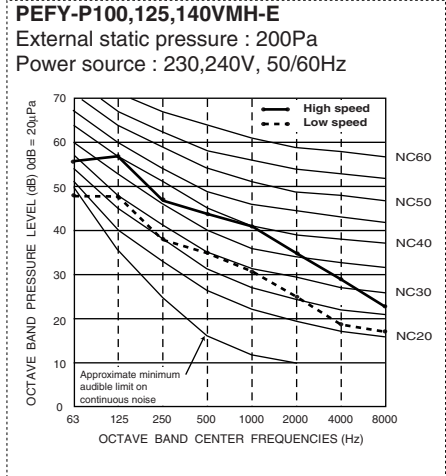
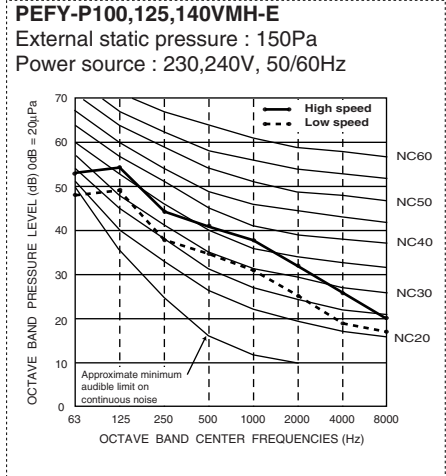
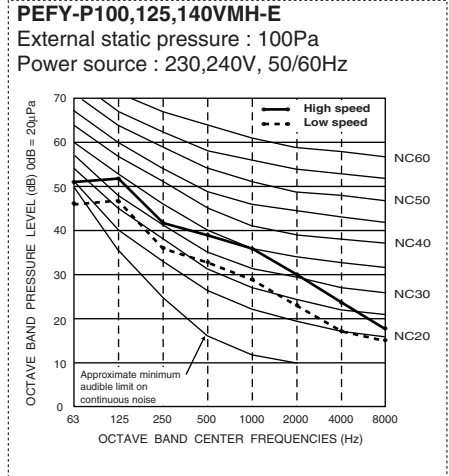

PEFY

# 5. SOUND LEVELS

PEFY

## 5-3. Fan characteristics curves

### PEFY-P20,25VMR-E-L/R

External static pressure : 5Pa  
Power source : 220,230,240V

Suction : Back inlet  
— 50Hz  
- - - 60Hz

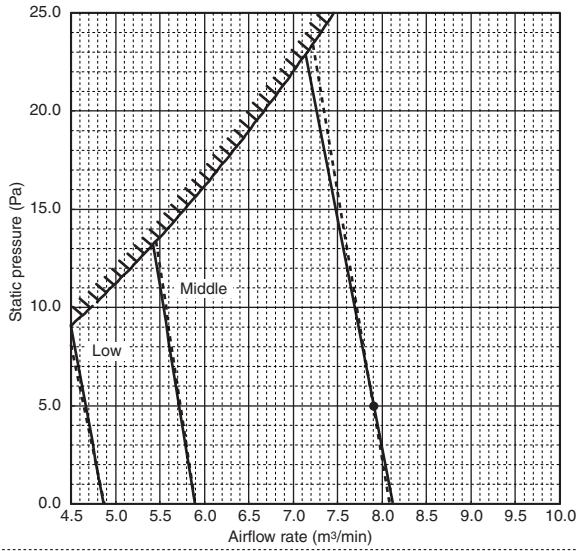

### PEFY-P32VMR-E-L/R

External static pressure : 5Pa  
Power source : 220,230,240V

Suction : Back inlet  
— 50Hz  
- - - 60Hz

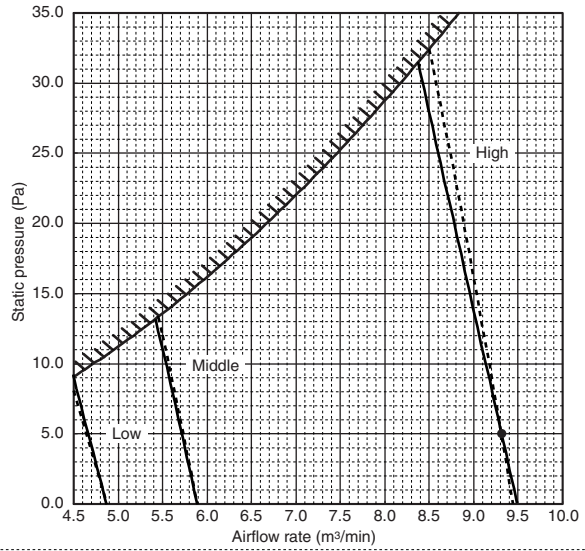

### PEFY-P15VMS1(L)-E

External static pressure : 5Pa  
Power source : 220,230,240V, 50/60Hz

Suction : Back inlet

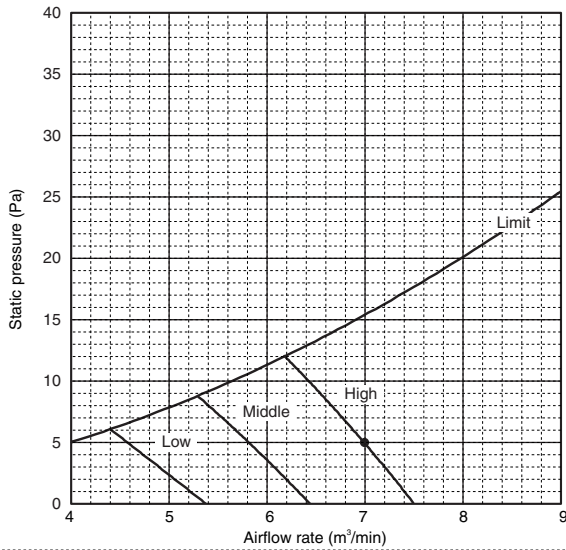

### PEFY-P15VMS1(L)-E

External static pressure : 15Pa  
Power source : 220,230,240V, 50/60Hz

Suction : Back inlet

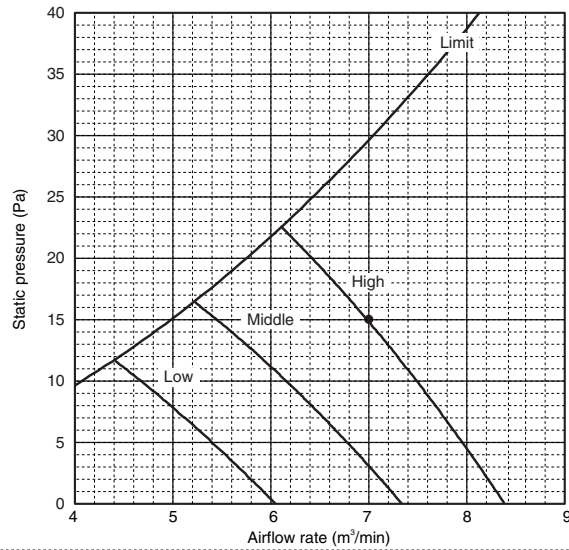

# 5. SOUND LEVELS

PEFY

## 5-3. Fan characteristics curves

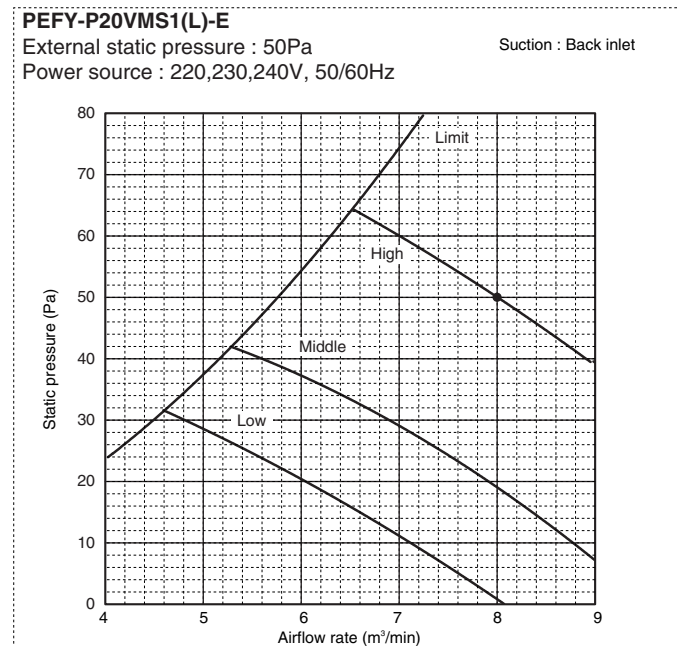
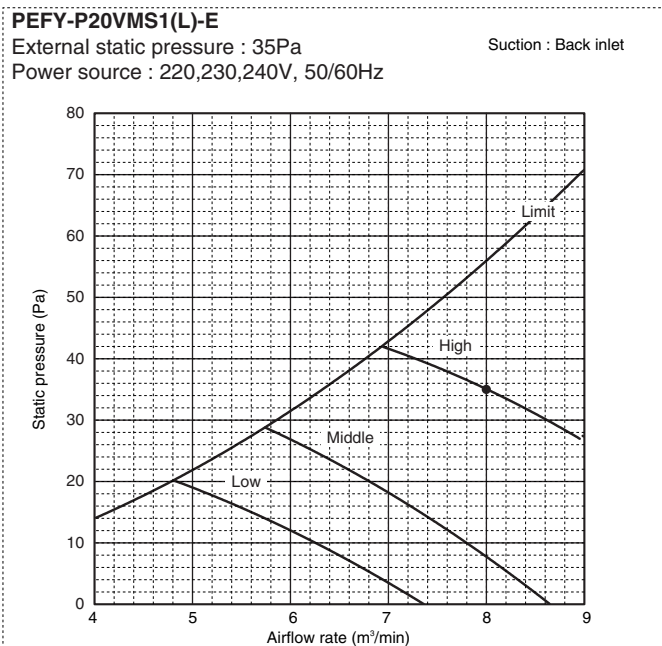
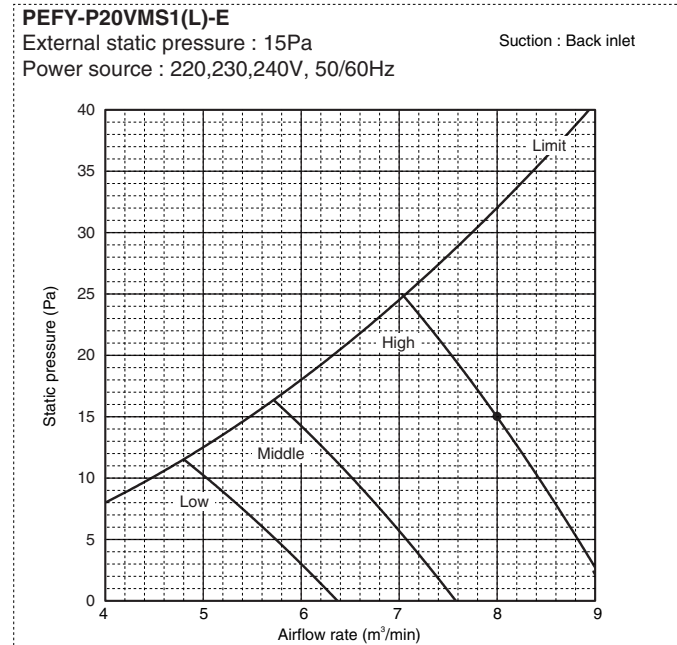
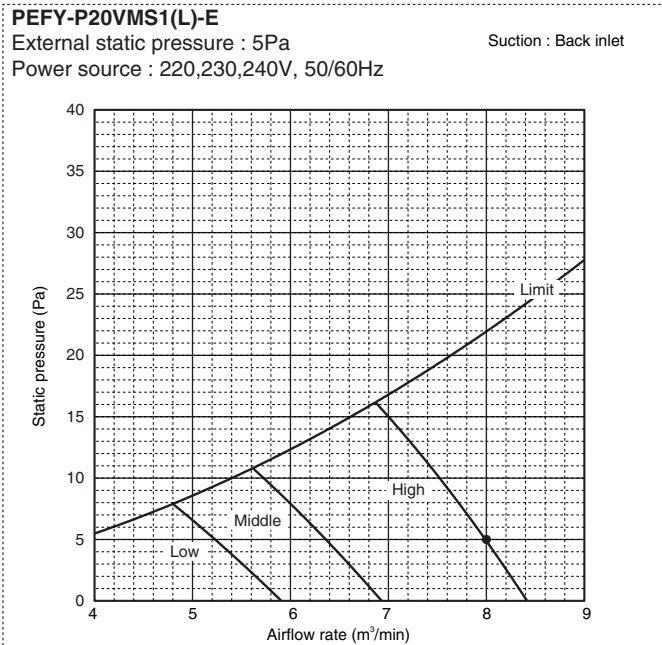
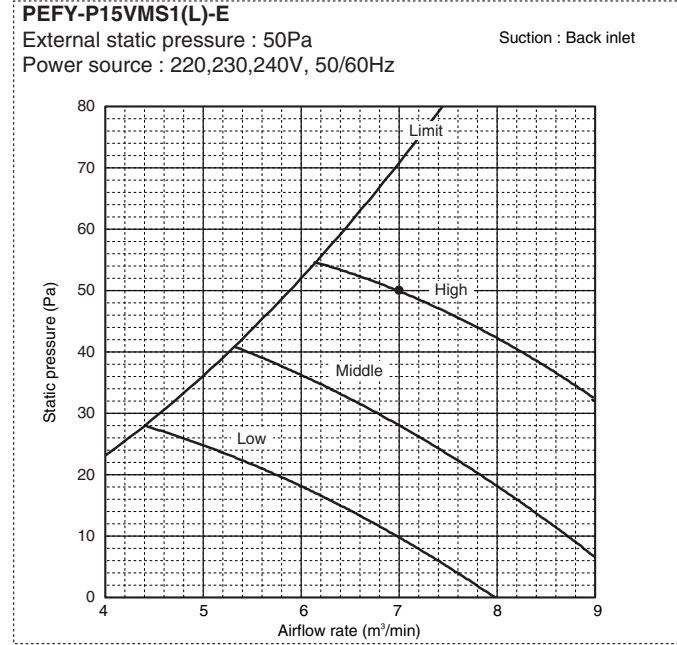
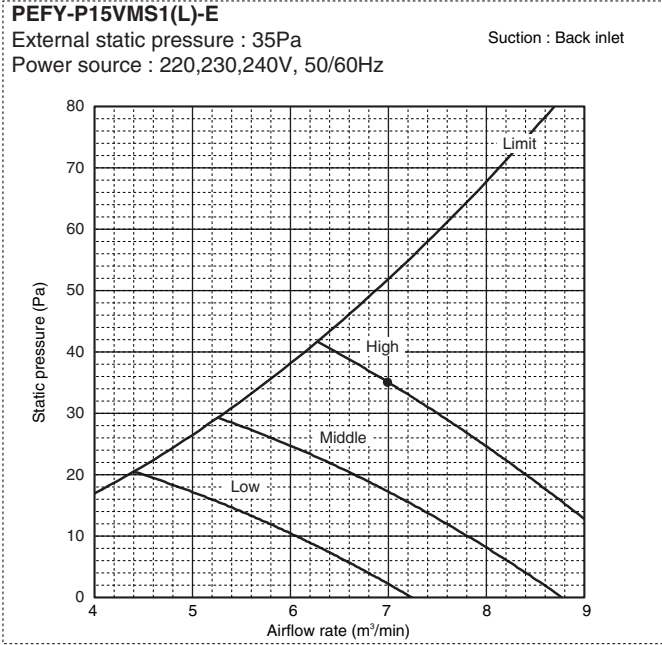

# 5. SOUND LEVELS

PEFY

## 5-3. Fan characteristics curves

### PEFY-P25VMS1(L)-E

External static pressure : 5Pa  
Power source : 220,230,240V, 50/60Hz

Suction : Back inlet

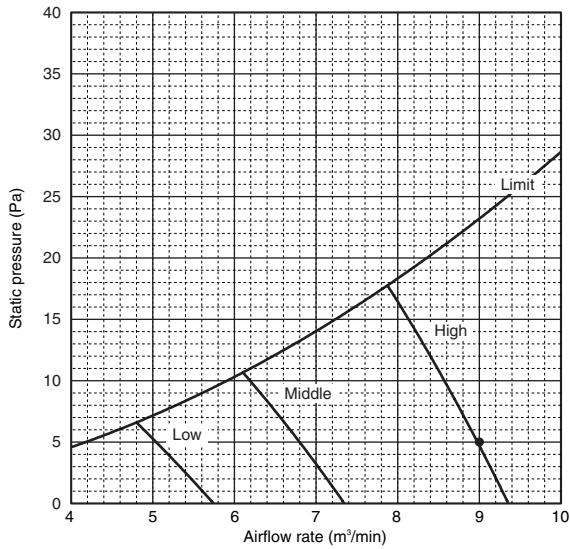

### PEFY-P25VMS1(L)-E

External static pressure : 15Pa  
Power source : 220,230,240V, 50/60Hz

Suction : Back inlet

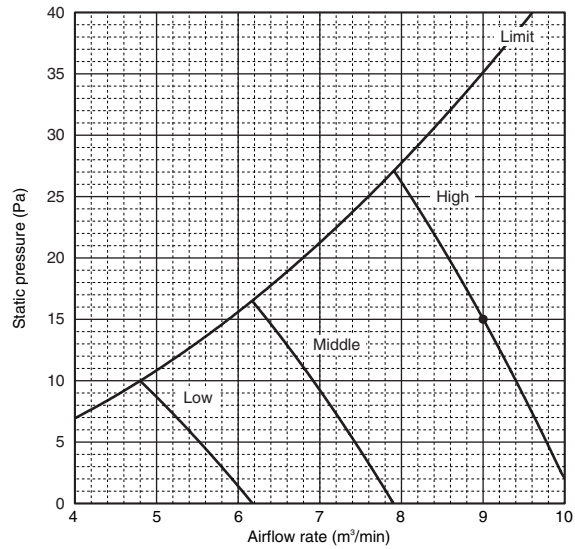

### PEFY-P25VMS1(L)-E

External static pressure : 35Pa  
Power source : 220,230,240V, 50/60Hz

Suction : Back inlet

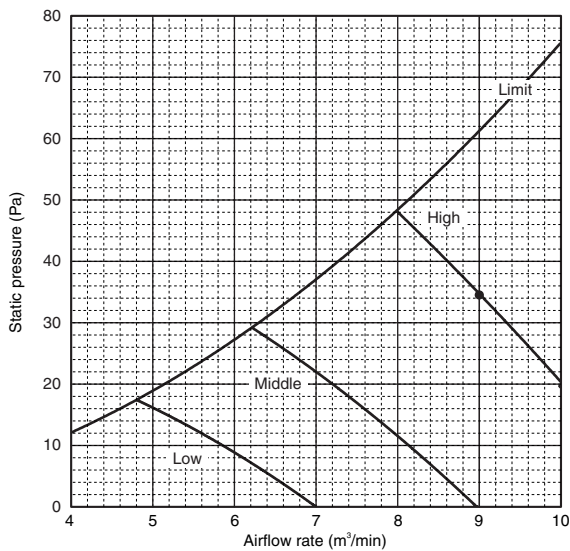

### PEFY-P25VMS1(L)-E

External static pressure : 50Pa  
Power source : 220,230,240V, 50/60Hz

Suction : Back inlet

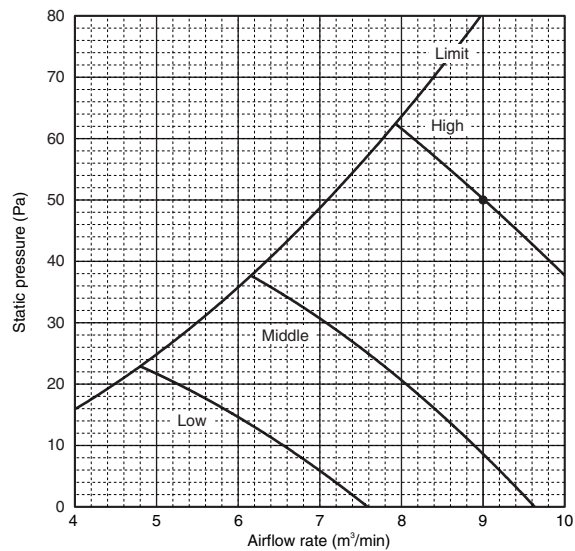

### PEFY-P32VMS1(L)-E

External static pressure : 5Pa  
Power source : 220,230,240V, 50/60Hz

Suction : Back inlet

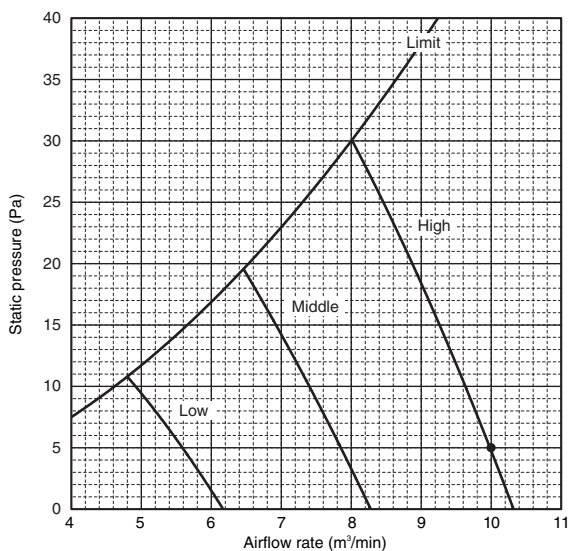

### PEFY-P32VMS1(L)-E

External static pressure : 15Pa  
Power source : 220,230,240V, 50/60Hz

Suction : Back inlet

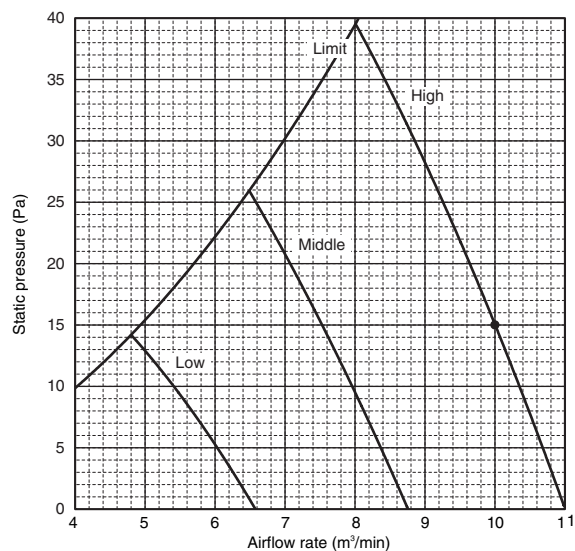



## 5-3. Fan characteristics curves

**PEFY-P32VMS1(L)-E**  
 External static pressure : 35Pa Suction : Back inlet  
 Power source : 220,230,240V, 50/60Hz

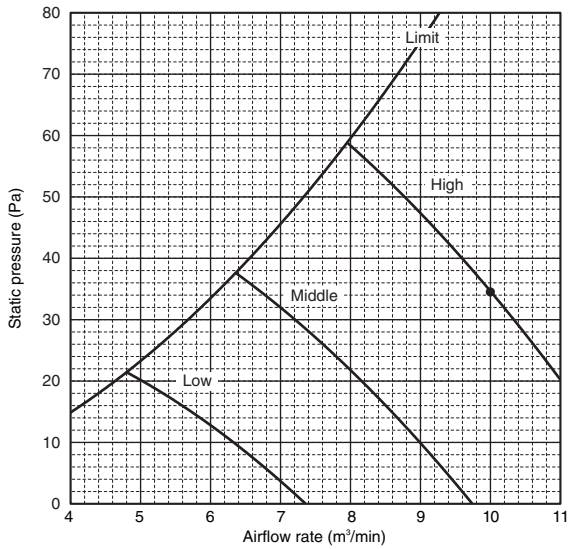

**PEFY-P32VMS(L)-E**  
 External static pressure : 50Pa Suction : Back inlet  
 Power source : 220,230,240V, 50/60Hz

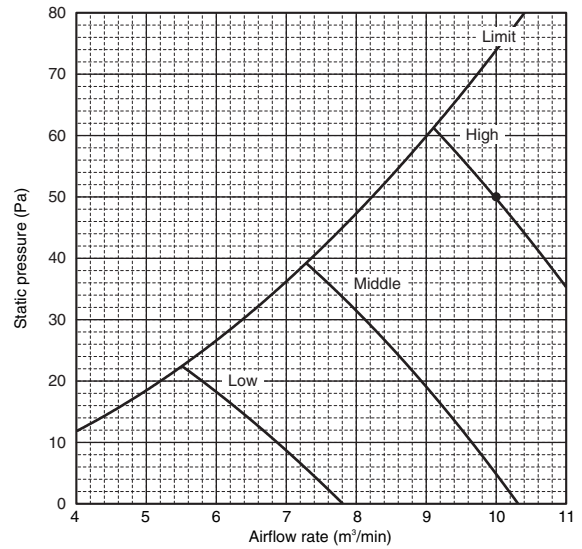

**PEFY-P40VMS1(L)-E**  
 External static pressure : 5Pa Suction : Back inlet  
 Power source : 220,230,240V, 50/60Hz

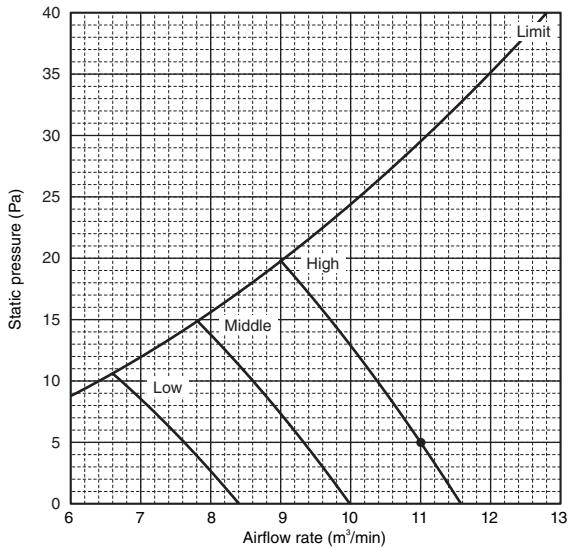

**PEFY-P40VMS1(L)-E**  
 External static pressure : 15Pa Suction : Back inlet  
 Power source : 220,230,240V, 50/60Hz

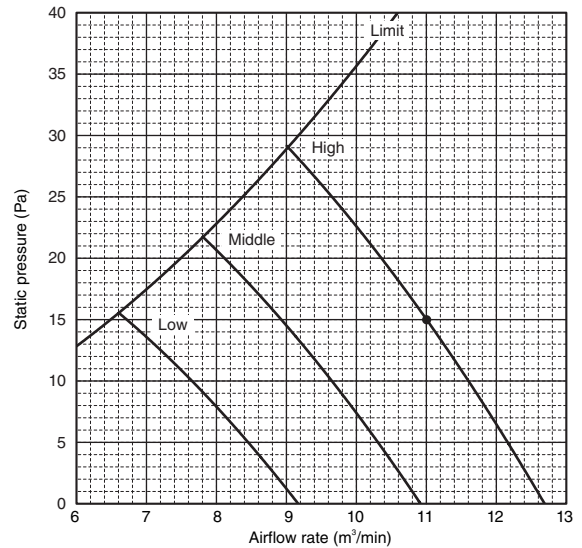

**PEFY-P40VMS1(L)-E**  
 External static pressure : 35Pa Suction : Back inlet  
 Power source : 220,230,240V, 50/60Hz

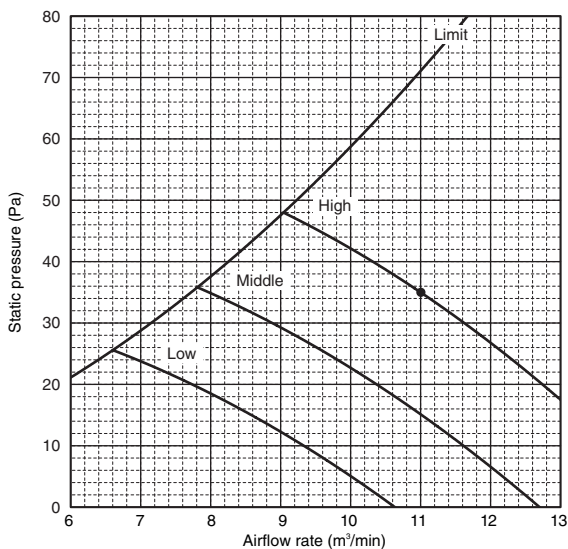

**PEFY-P40VMS1(L)-E**  
 External static pressure : 50Pa Suction : Back inlet  
 Power source : 220,230,240V, 50/60Hz

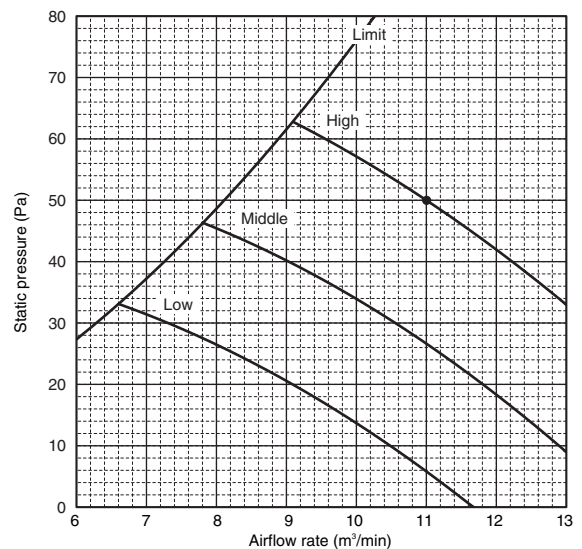

# 5. SOUND LEVELS

PEFY

## 5-3. Fan characteristics curves

### PEFY-P50VMS1(L)-E

External static pressure : 5Pa  
Power source : 220,230,240V, 50/60Hz

Suction : Back inlet

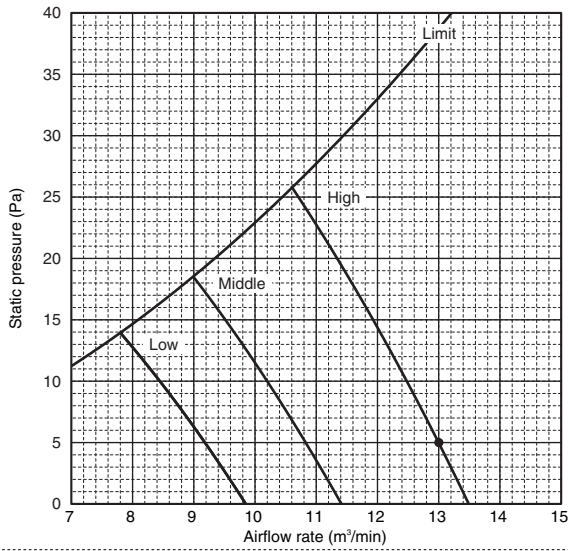

### PEFY-P50VMS1(L)-E

External static pressure : 15Pa  
Power source : 220,230,240V, 50/60Hz

Suction : Back inlet

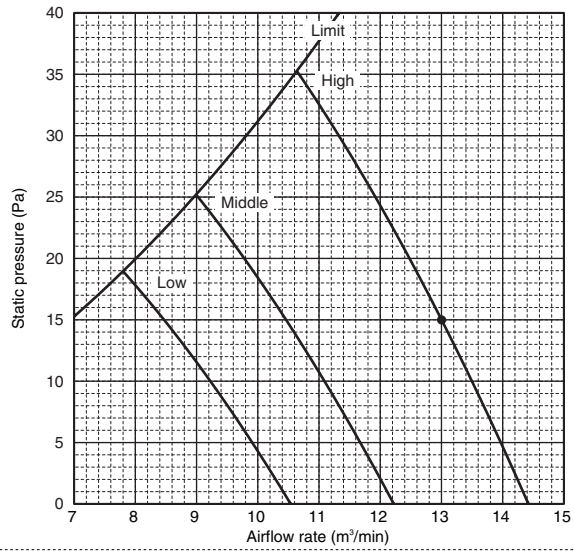

### PEFY-P50VMS1(L)-E

External static pressure : 35Pa  
Power source : 220,230,240V, 50/60Hz

Suction : Back inlet

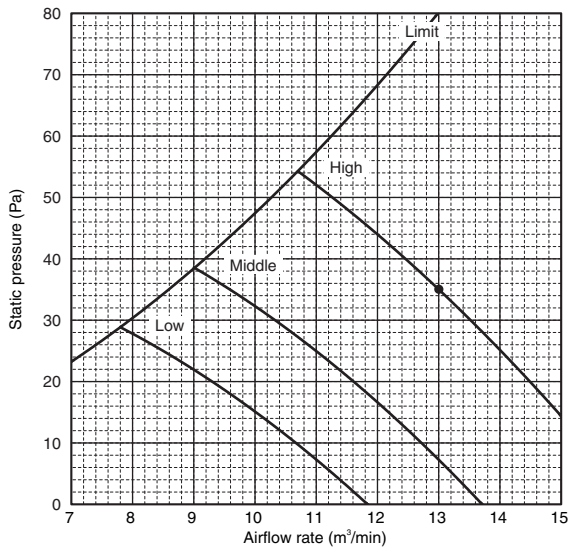

### PEFY-P50VMS1(L)-E

External static pressure : 50Pa  
Power source : 220,230,240V, 50/60Hz

Suction : Back inlet

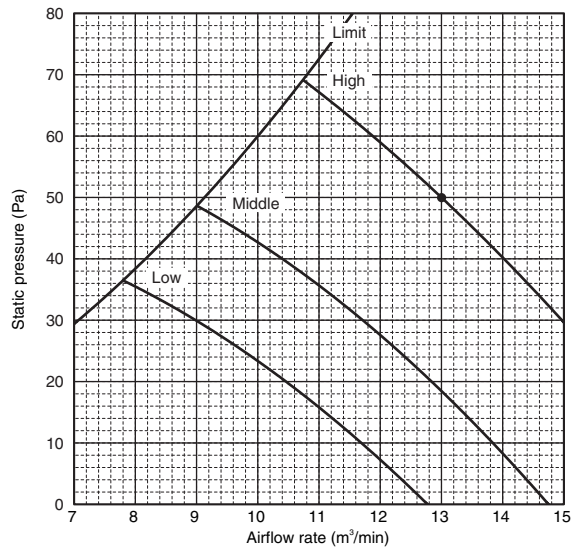

### PEFY-P63VMS1(L)-E

External static pressure : 5Pa  
Power source : 220,230,240V, 50/60Hz

Suction : Back inlet

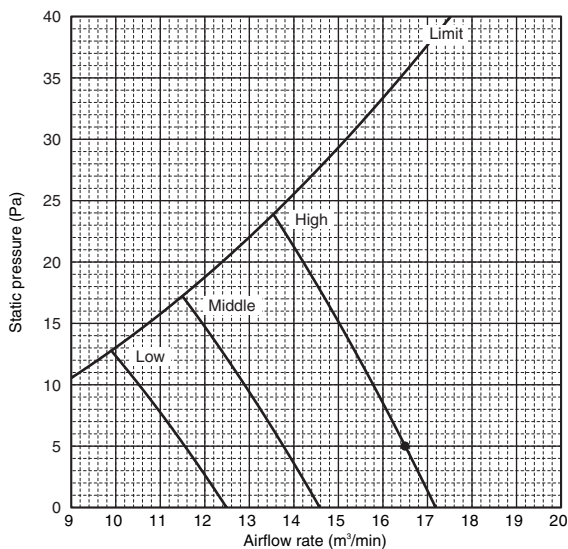

### PEFY-P63VMS1(L)-E

External static pressure : 15Pa  
Power source : 220,230,240V, 50/60Hz

Suction : Back inlet

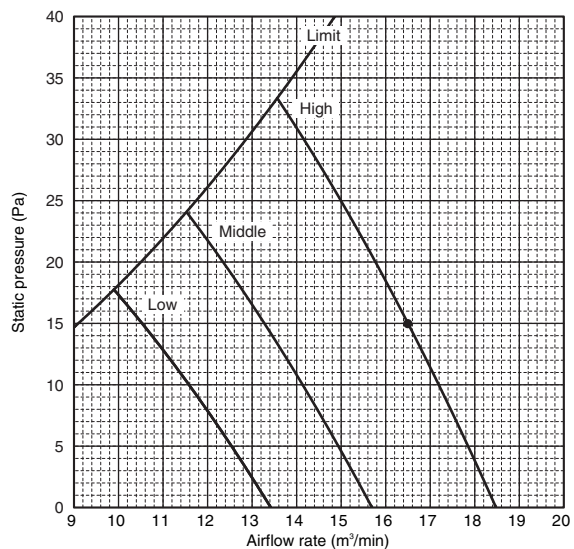

## 5-3. Fan characteristics curves

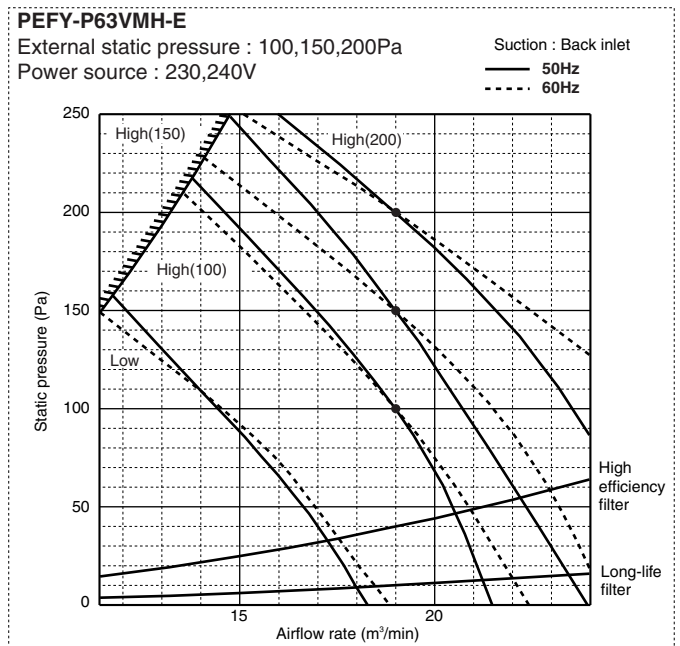
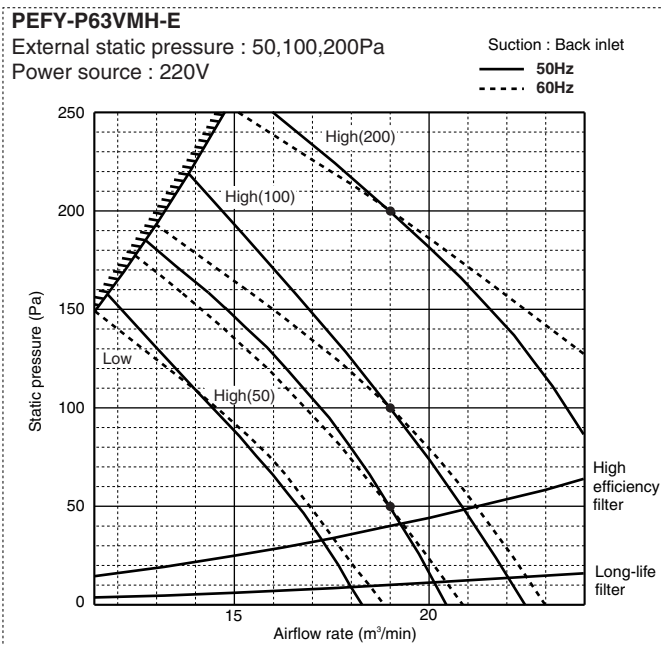
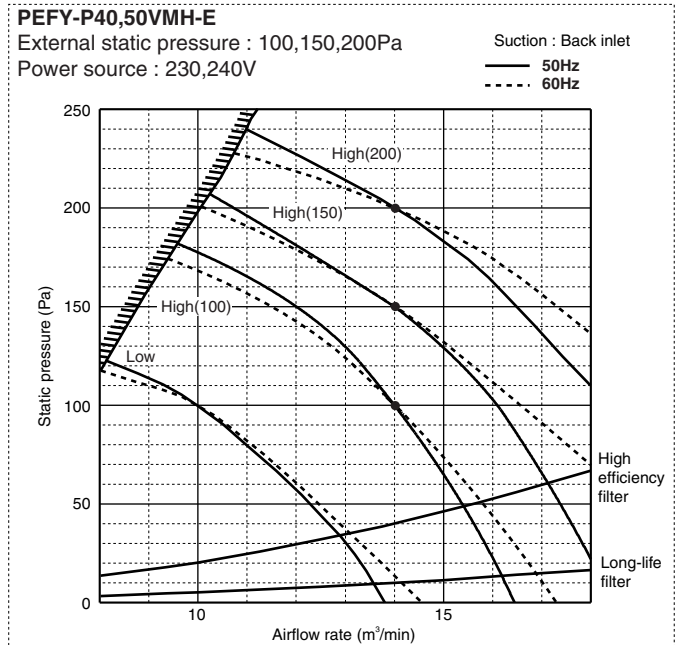
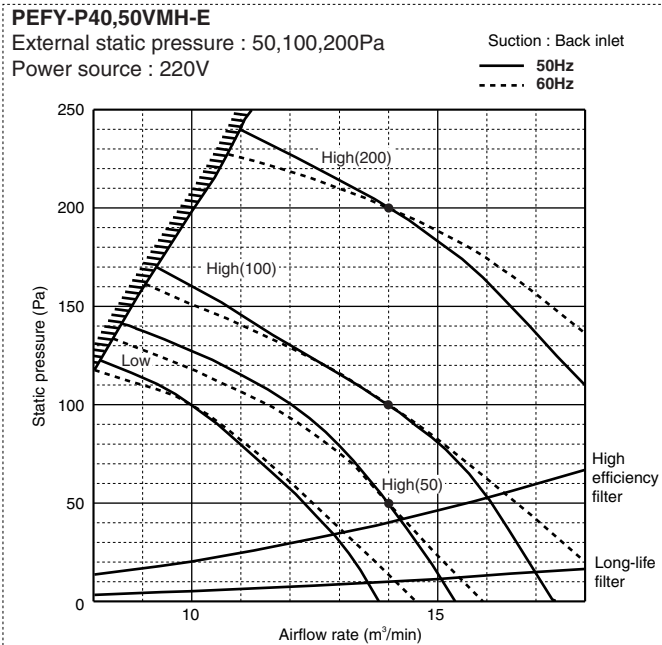
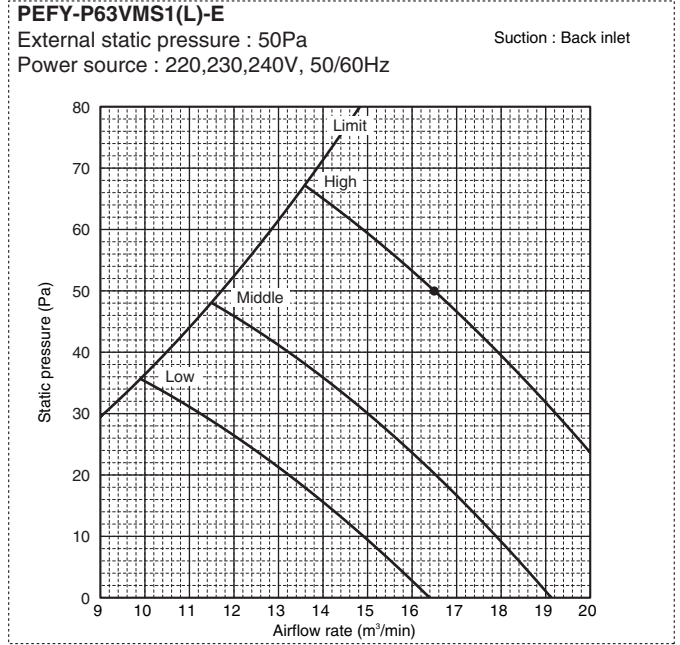
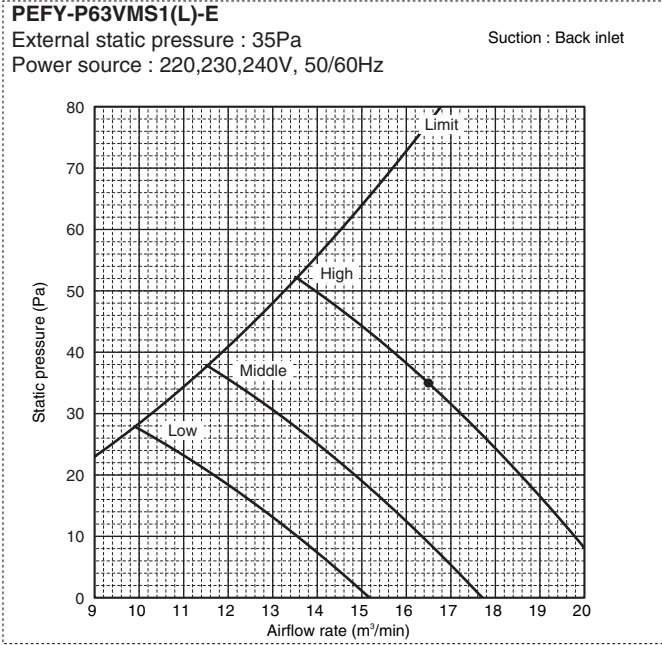



5-3. Fan characteristics curves

PEFY-P71VMH-E

External static pressure : 50,100,200Pa  
Power source : 220V

Suction : Back inlet  
— 50Hz  
- - - 60Hz

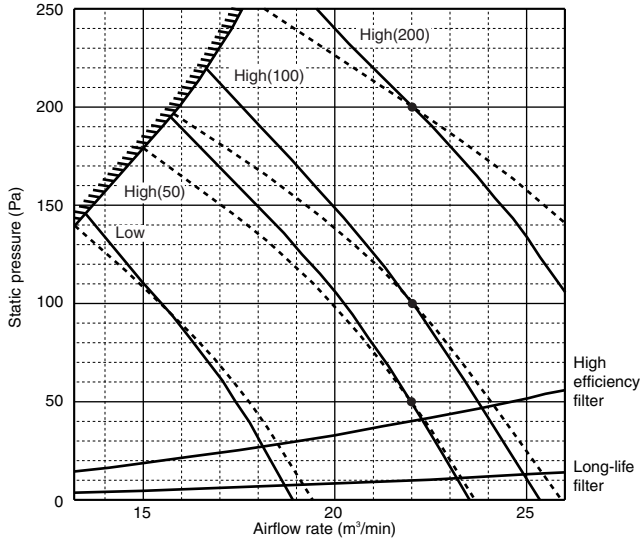

PEFY-P71VMH-E

External static pressure : 100,150,200Pa  
Power source : 230,240V

Suction : Back inlet  
— 50Hz  
- - - 60Hz

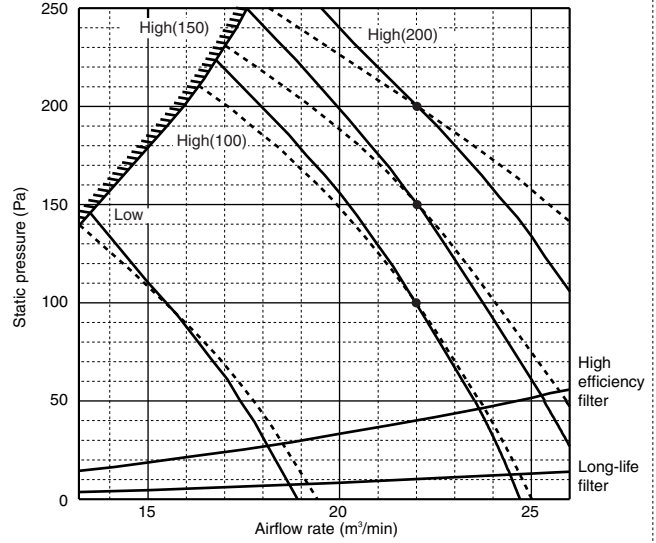

PEFY-P80VMH-E

External static pressure : 50,100,200Pa  
Power source : 220V

Suction : Back inlet  
— 50Hz  
- - - 60Hz

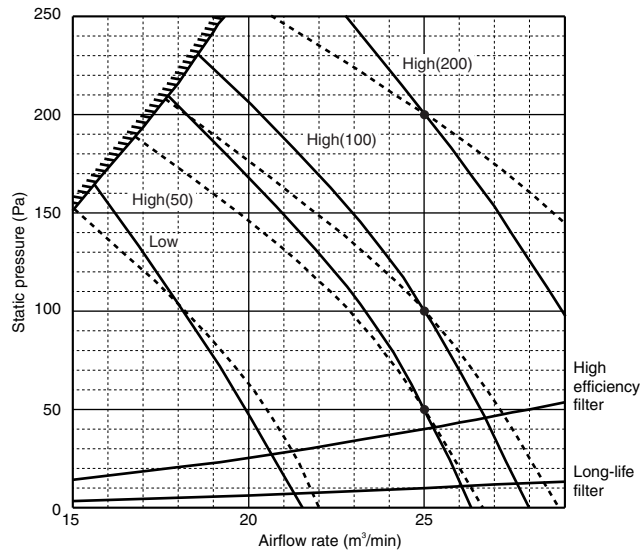

PEFY-P80VMH-E

External static pressure : 100,150,200Pa  
Power source : 230,240V

Suction : Back inlet  
— 50Hz  
- - - 60Hz

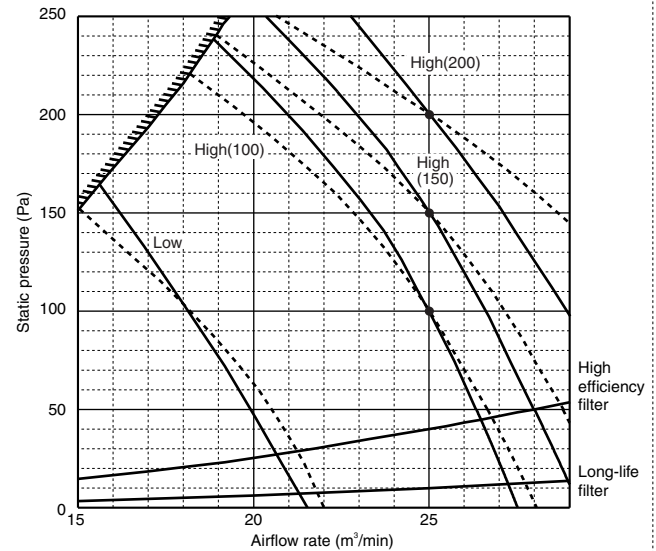

PEFY-P100,125VMH-E

External static pressure : 50,100,200Pa  
Power source : 220V

Suction : Back inlet  
— 50Hz  
- - - 60Hz

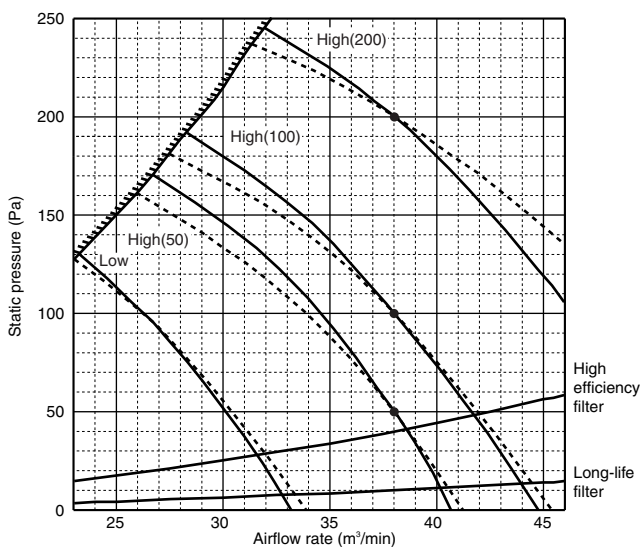

PEFY-P100,125VMH-E

External static pressure : 100,150,200Pa  
Power source : 230,240V

Suction : Back inlet  
— 50Hz  
- - - 60Hz

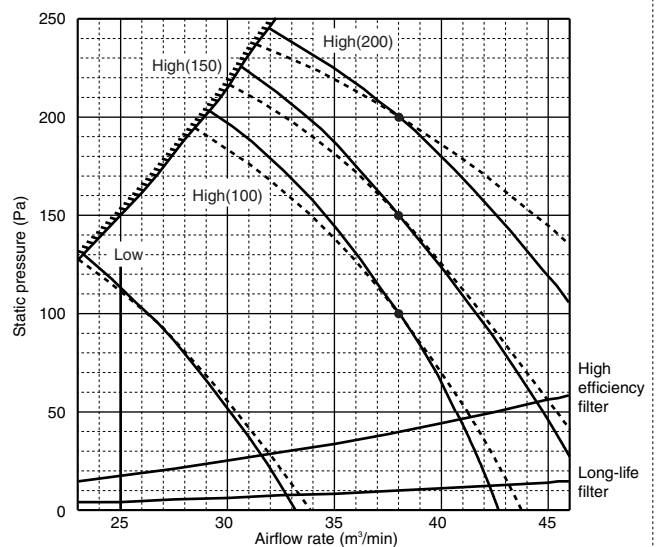



5-3. Fan characteristics curves

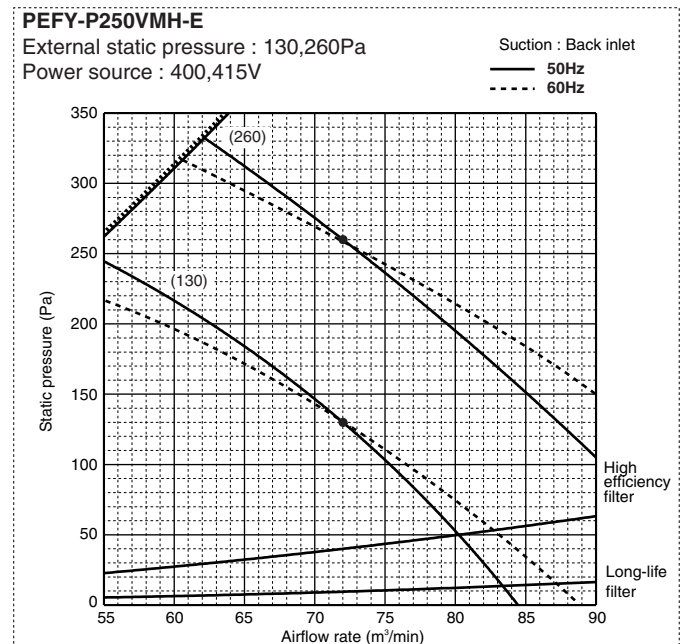
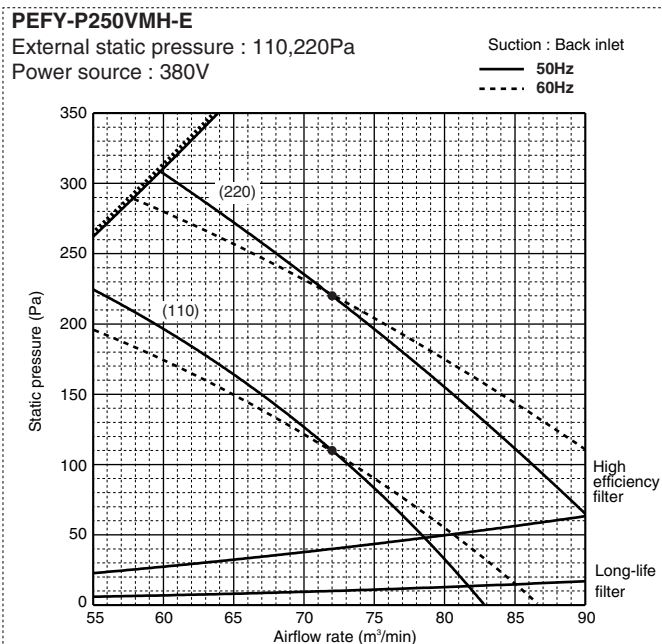
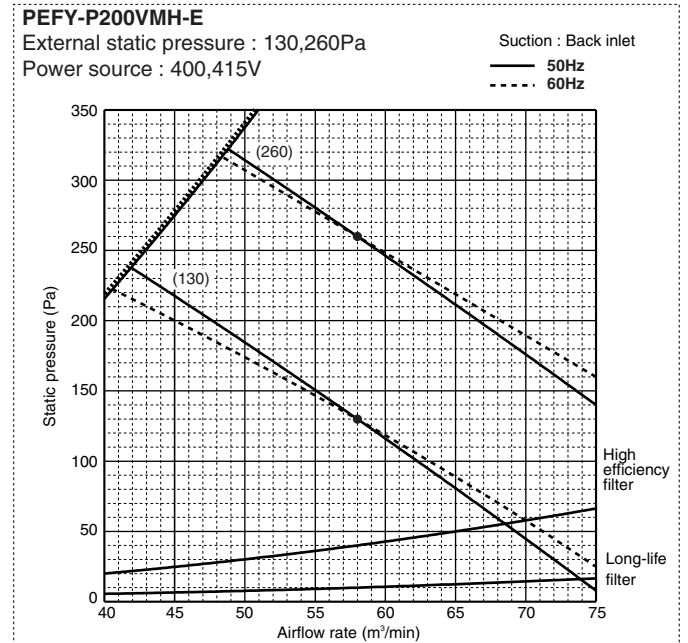
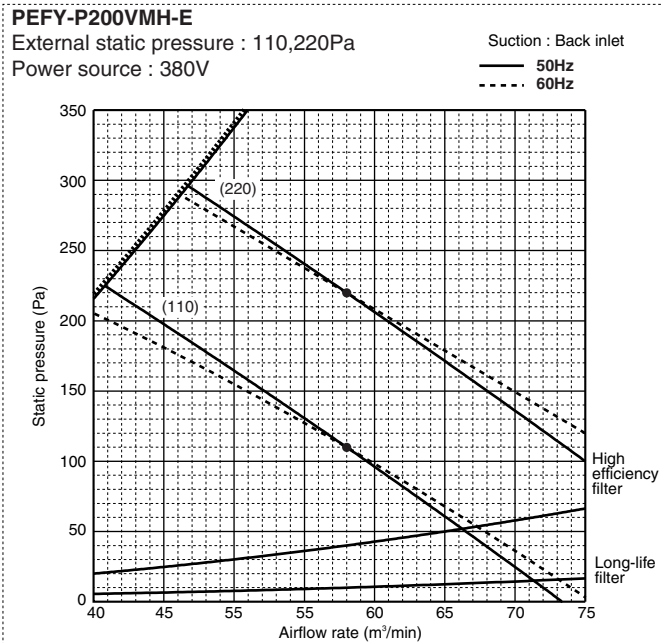
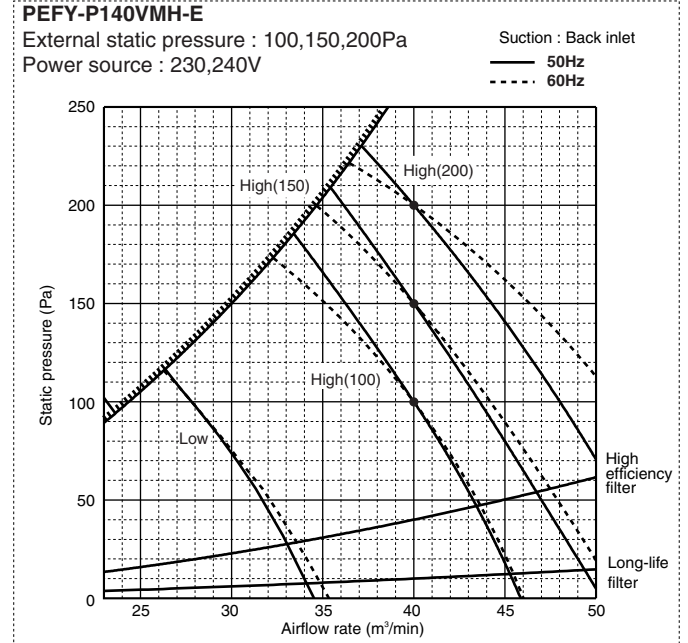
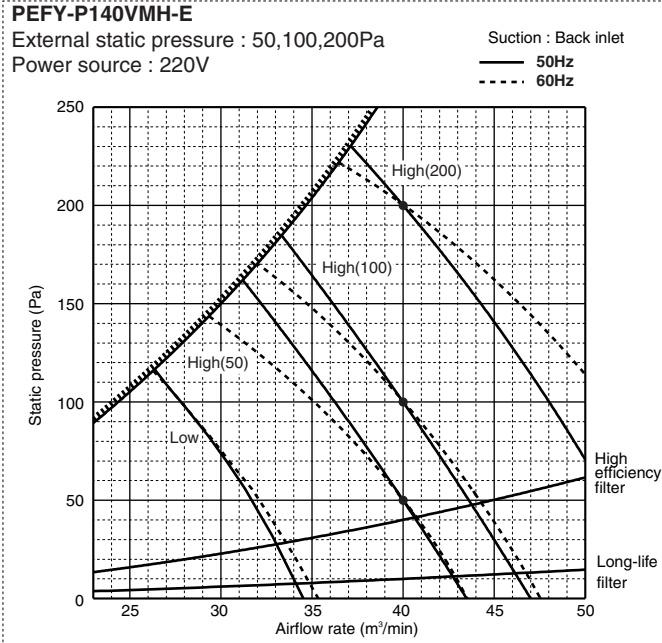

## Optional parts line up for the Indoor unit

	Drain pump	Control box replace kit
PEFY-P15,20,25,32,40,50,63VMS1-E	-	PAC-KE70HS-E
PEFY-P15,20,25,32,40,50,63VMS1L-E	PAC-KE07DM-E	PAC-KE70HS-E

## PEFY-P-VMS1 (L) -E

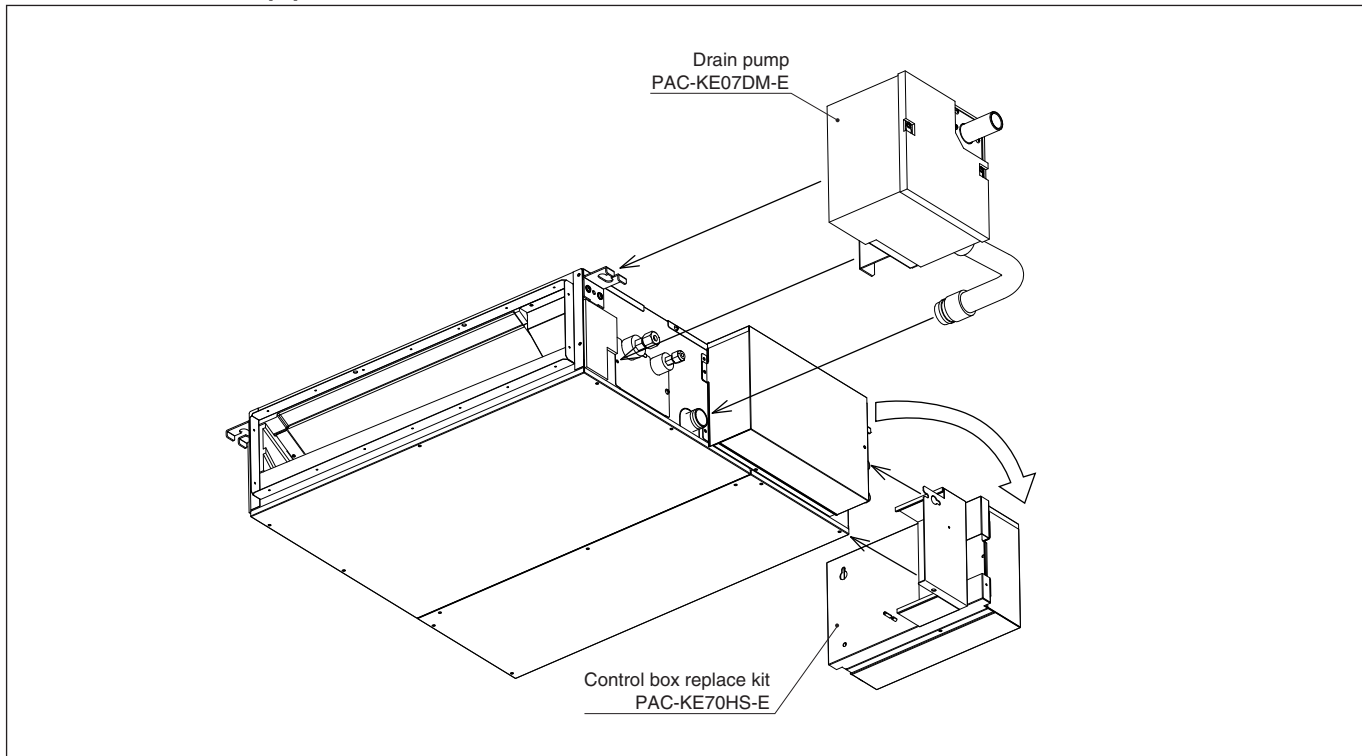







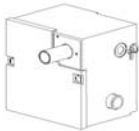

## Optional parts line up for the Indoor unit



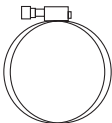

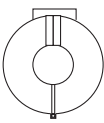
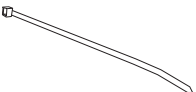

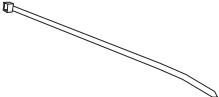



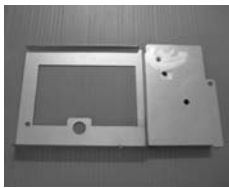



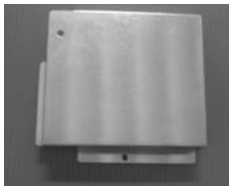



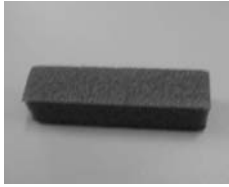

	Drain pump	Control box replace kit
PEFY-P15,20,25,32,40,50,63VMS1-E	-	PAC-KE70HS-E
PEFY-P15,20,25,32,40,50,63VMS1L-E	PAC-KE07DM-E	PAC-KE70HS-E

## Drain pump PAC-KE07DM-E

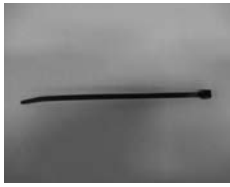
Drain pump is an optional part for VMS1L, and a standard for VMS1. When using drain pump, PAC-KE07DM-E (mounting type) is required.

Item	① Drain pump	② Attachment	③ Drain hose 1 (385mm)	④ Pipe cover 1 (255mm)	⑤ Pipe cover 2 (200mm)
Quantity	1	1	1	1	1
Shape					
Item	⑥ Hose band	⑦ Screw	⑧ Clamp	⑨ Ferrite clamp	⑩ Band 1 (100mm)
Quantity	1	3	3	1	2
Shape					
Item	⑪ Drain hose 2 (175mm)	⑫ Pipe cover 3	⑬ Band 2 (380mm)		
Quantity	1	1	6		
Shape					

■ Control box replace kit PAC-KE70HS-E

Parts	① PLATE A	② PLATE B	③ PLATE C	④ COVER A
Q'ty	1	1	1	1
Shape				
Parts	⑤ COVER B	⑥ LEAD WIRE MOTOR	⑦ LEAD WIRE LEV	⑧ LEAD WIRE THM A
Q'ty	1	1	1	1
Shape		 White 7-pin connector	 White 6-pin connector	 White 4-pin connector
Parts	⑨ LEAD WIRE THM B	⑩ LEAD WIRE EARTH	⑪ LEAD WIRE PUMP	⑫ LEAD WIRE FS
Q'ty	1	1	1	1
Shape	 Red 2-pin connector	 Ring terminal on both ends	 Blue 3-pin connector	 White 4-pin connector
Parts	⑬ INSULATOR	⑭ Connecting terminals	⑮ BAND	⑯ CLAMP
Q'ty	3	4	6	4
Shape				
Parts	⑰ SCREW 1	⑱ SCREW 2	⑲ SCREW 3	⑳ FERRITE CORE
Q'ty	2	4	5	1
Shape	 4X10	 4X10 with a washer	 5X10 with a washer	

When installing the control box replace kit on the air inlet on the unit, ⑫LEAD WIRE FS is not used.

## ■ Optional parts line up for the Indoor unit

	Long-life filter	Filter box	Drain pump
PEFY-P40,50,63VMH-E	PAC-KE86LAF	PAC-KE63TB-F	PAC-KE04DM-F
PEFY-P71,80VMH-E	PAC-KE88LAF	PAC-KE80TB-F	PAC-KE04DM-F
PEFY-P100,125,140VMH-E	PAC-KE89LAF	PAC-KE140TB-F	PAC-KE04DM-F
PEFY-P200,250VMH-E	PAC-KE85LAF	PAC-KE250TB-F	PAC-KE04DM-F

### ● PEFY-P-VMH-E

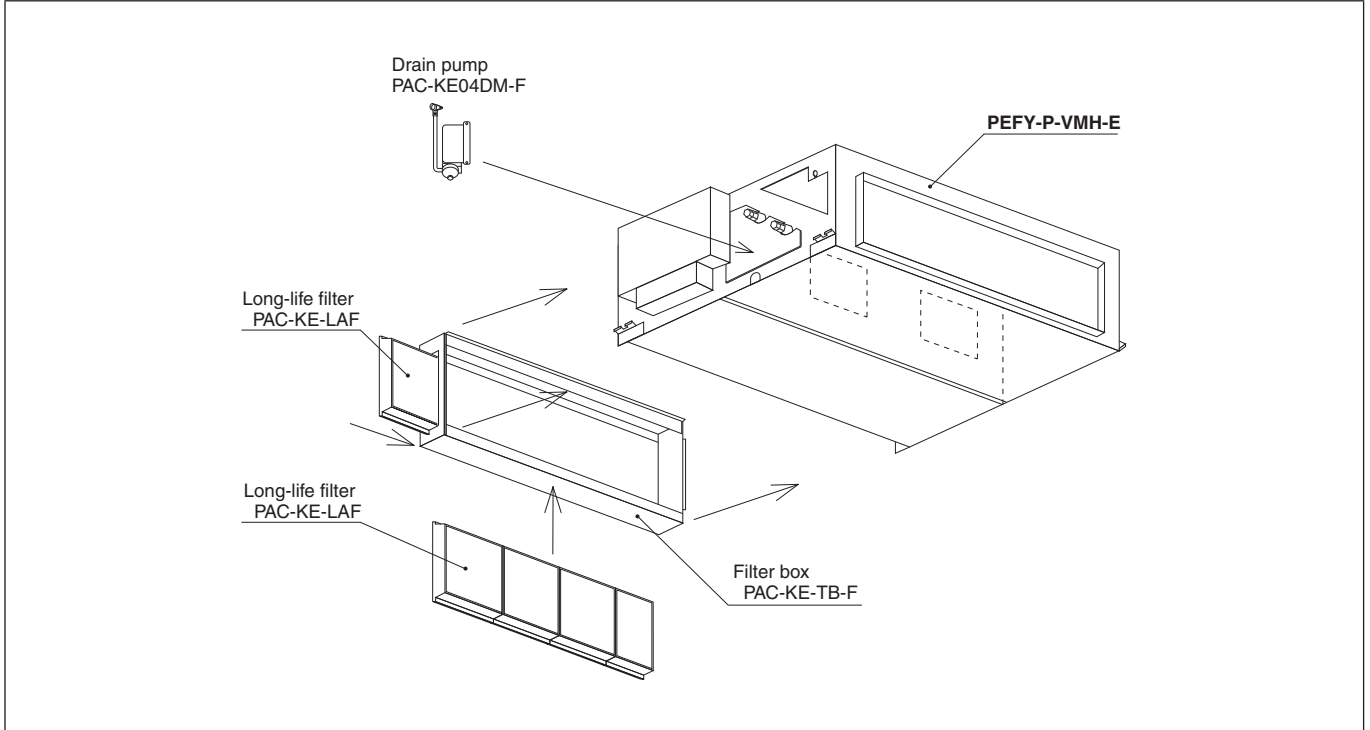

## Optional parts line up for the Indoor unit

	Long-life filter	Filter box	Drain pump
PEFY-P40,50,63VMH-E	PAC-KE86LAF	PAC-KE63TB-F	PAC-KE04DM-F
PEFY-P71,80VMH-E	PAC-KE88LAF	PAC-KE80TB-F	PAC-KE04DM-F
PEFY-P100,125,140VMH-E	PAC-KE89LAF	PAC-KE140TB-F	PAC-KE04DM-F
PEFY-P200,250VMH-E	PAC-KE85LAF	PAC-KE250TB-F	PAC-KE04DM-F

## Long-life filter PAC-KE-LAF and filter box PAC-KE-TB-F for PEFY-P-VMH-E

Life span: 2,500 hr (Dust concentration 0.15mg/m<sup>3</sup>)  
 \*. The actual dust situation affects the filter life span, which should be considered at the applying site.  
 Material: Synthetic fiber unwoven cloth filter  
 Static pressure loss is referred to 5-3 "Fan characteristics curves".  
 Long-life filter should be used together with filter box PAC-KE-TB-F.

**PAC-KE-LAF**

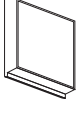
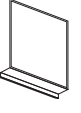
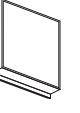
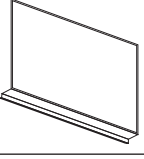
Item	PAC-KE86LAF	PAC-KE88LAF	PAC-KE89LAF	PAC-KE85LAF
Quantity	2	3	3	2
Shape	(298X300) 	(298X300) 	(298X300) 	(411X600) 

Detailed installation information should be referred to its Installation Manual (WT02574X06)



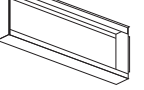
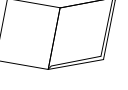



**PAC-KE-TB-F**

Item	① Screw	② Filter box	③ Installation manual	
Quantity	10/12*	1	1	
Shape				*PAC-KE250TB has 12 pieces of screw.

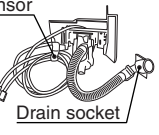
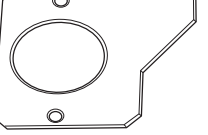
Detailed installation information should be referred to its Installation Manual (WT03018X03, WT03019X03)

## Drain pump PAC-KE04DM-F

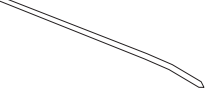
If drain water can not flow out the Indoor unit by gravity and gradient, a Drain-pump for draining is needed.  
 Drain pump PAC-KE04DM-F can pump water up to 550mm high from the drain pan.

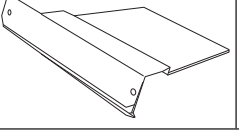
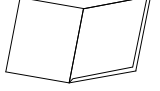
Item	① Drain pump ass'y	② Separator	③ Rubber plug	④ Connector	⑤ Dummy connector
Quantity	1	1	2	1	1
Shape					
Item	⑥ Rubber bushing	⑦ Band	⑧ PTT screw 4X10	⑨ Fixing plate	⑩ Installation manual
Quantity	1	2	6+1 (spare)	1	1
Shape					

Detailed installation information should be referred to its Installation Manual (WT03312X07)