

TECHNICAL & SERVICE MANUAL

Series PKFY Wall Mounted R410A / R407C / R22

Indoor unit
[Model names]

[Service Ref.]

PKFY-P63VKM-E

PKFY-P63VKM-E.TH

PKFY-P100VKM-E

PKFY-P100VKM-E.TH

Note:

- This manual describes only service data of the indoor units.
- RoHS compliant products have <G> mark on the spec name plate.

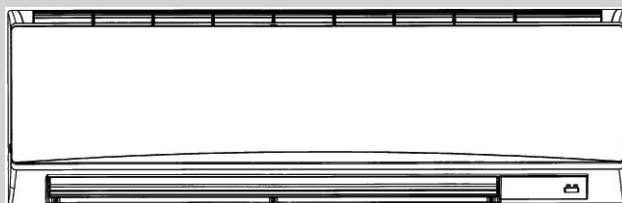

INDOOR UNIT

CONTENTS

1. SAFETY PRECAUTION.....	2
2. PART NAMES AND FUNCTIONS	5
3. SPECIFICATION	8
4. OUTLINES AND DIMENSIONS.....	10
5. WIRING DIAGRAM	11
6. REFRIGERANT SYSTEM DIAGRAM.....	12
7. TROUBLESHOOTING	12
8. DISASSEMBLY PROCEDURE	20

PARTS CATALOG (OCB447)

CAUTIONS RELATED TO NEW REFRIGERANT**Cautions for units utilizing refrigerant R407C****Do not use the existing refrigerant piping.**

The old refrigerant and lubricant in the existing piping contain a large amount of chlorine which may cause the lubricant deterioration of the new unit.

Use liquid refrigerant to charge the system.

If gas refrigerant is used to seal the system, the composition of the refrigerant in the cylinder will change and performance may drop.

Use “low residual oil piping”

If there is a large amount of residual oil (hydraulic oil, etc.) inside the piping and joints, deterioration of the lubricant will result.

Do not use a refrigerant other than R407C.

If another refrigerant (R22, etc.) is used, the chlorine in the refrigerant may cause the lubricant deterioration.

**Store the piping to be used indoors during installation and both ends sealed until just before brazing.
(Store elbows and other joints in a plastic bag.)**

If dust, dirt, or water enters the refrigerant cycle, deterioration of the oil and compressor trouble may result.

Use a vacuum pump with a reverse flow check valve.

The vacuum pump oil may flow back into the refrigerant cycle and cause the lubricant deterioration.

Use ESTR , ETHER or HAB as the lubricant to coat flares and flange connection parts.

If large amount of mineral oil enters, that can cause deterioration of refrigerant oil etc.

Ventilate the room if refrigerant leaks during operation. If refrigerant comes into contact with a flame, poisonous gases will be released.**[1] Cautions for service**

- After recovering the all refrigerant in the unit, proceed to working.
- Do not release refrigerant in the air.
- After completing the repair service, recharge the cycle with the specified amount of liquid refrigerant.

[2] Refrigerant recharging

(1) Refrigerant recharging process

① Direct charging from the cylinder.

- R407C cylinder available on the market has a syphon pipe.
 - Leave the syphon pipe cylinder standing and recharge it.
- (By liquid refrigerant)

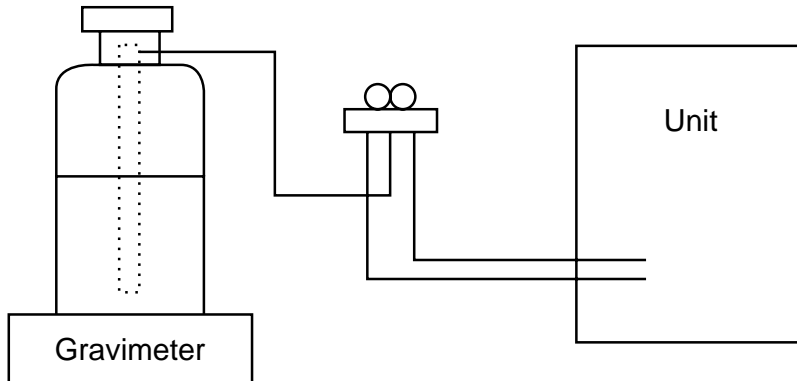

(2) Recharge in refrigerant leakage case

- After recovering the all refrigerant in the unit, proceed to working.
- Do not release the refrigerant in the air.
- After completing the repair service, recharge the cycle with the specified amount of liquid refrigerant.

[3] Service tools

Use the below service tools as exclusive tools for R407C refrigerant.

No.	Tool name	Specifications
①	Gauge manifold	·Only for R407C
		·Use the existing fitting SPECIFICATIONS. (UNF7/16)
		·Use high-tension side pressure of 3.43MPa·G or over.
②	Charge hose	·Only for R407C
		·Use pressure performance of 5.10MPa·G or over.
③	Electronic scale	_____
④	Gas leak detector	·Use the detector for R134a or R407C.
⑤	Adapter for reverse flow check	·Attach to vacuum pump.
⑥	Refrigerant charge base	_____
⑦	Refrigerant cylinder	·For R407C
		·Top of cylinder (Brown) ·Cylinder with syphon
⑧	Refrigerant recovery equipment	_____

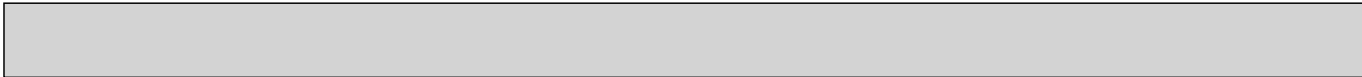

Cautions for units utilizing refrigerant R410A

Do not use the existing refrigerant piping.
The old refrigerant and lubricant in the existing piping contains a large amount of chlorine which may cause the lubricant deterioration of the new unit.

Use “low residual oil piping”
If there is a large amount of residual oil (hydraulic oil, etc.) inside the piping and joints, deterioration of the lubricant will result.

Store the piping to be used indoors during installation and both ends of the piping sealed until just before brazing. (Leave elbow joints, etc. in their packaging.)
If dirt, dust or moisture enters into refrigerant cycle, that can cause deterioration of refrigerant oil or malfunction of compressor.

Use ester oil, ether oil or alkylbenzene oil (small amount) as the refrigerant oil applied to flares and flange connections.
If large amount of mineral oil enters, that can cause deterioration of refrigerant oil etc.

Charge refrigerant from liquid phase of gas cylinder.
If the refrigerant is charged from gas phase, composition change may occur in refrigerant and the efficiency will be lowered.

Do not use refrigerant other than R410A.
If other refrigerant (R22 etc.) is used, chlorine in refrigerant can cause deterioration of refrigerant oil etc.

Use a vacuum pump with a reverse flow check valve.
Vacuum pump oil may flow back into refrigerant cycle and that can cause deterioration of refrigerant oil etc.

Use the following tools specifically designed for use with R410A refrigerant.
The following tools are necessary to use R410A refrigerant.

Tools for R410A	
Gauge manifold	Flare tool
Charge hose	Size adjustment gauge
Gas leak detector	Vacuum pump adaptor
Torque wrench	Electronic refrigerant charging scale

Handle tools with care.
If dirt, dust or moisture enters into refrigerant cycle, that can cause deterioration of refrigerant oil or malfunction of compressor.

Do not use a charging cylinder.
If a charging cylinder is used, the composition of refrigerant will change and the efficiency will be lowered.

Ventilate the room if refrigerant leaks during operation. If refrigerant comes into contact with a flame, poisonous gases will be released.

[1] Cautions for service

- (1) Perform service after recovering the refrigerant left in unit completely.
- (2) Do not release refrigerant in the air.
- (3) After completing service, charge the cycle with specified amount of refrigerant.
- (4) When performing service, install a filter drier simultaneously.
Be sure to use a filter drier for new refrigerant.

[2] Additional refrigerant charge

When charging directly from cylinder

- Check that cylinder for R410A on the market is syphon type.
- Charging should be performed with the cylinder of syphon stood vertically. (Refrigerant is charged from liquid phase.)

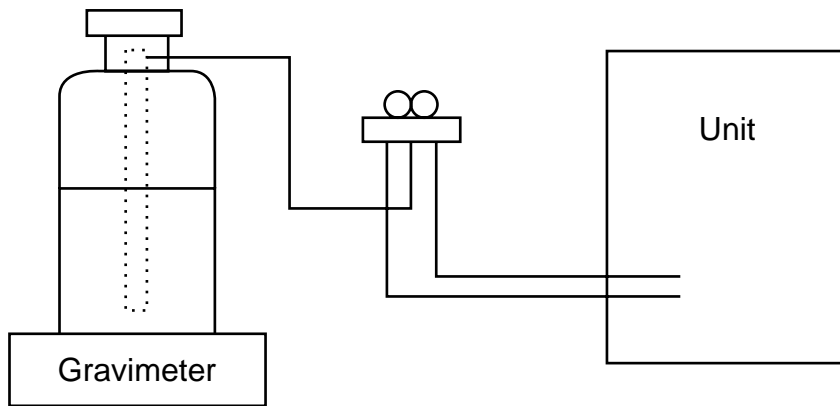

[3] Service tools

Use the below service tools as exclusive tools for R410A refrigerant.

No.	Tool name	Specifications
①	Gauge manifold	·Only for R410A
		·Use the existing fitting specifications. (UNF1/2)
		·Use high-tension side pressure of 5.3MPa-G or over.
②	Charge hose	·Only for R410A
		·Use pressure performance of 5.09MPa-G or over.
③	Electronic scale	—
④	Gas leak detector	·Use the detector for R134a, R407C or R410A.
⑤	Adaptor for reverse flow check	·Attach to vacuum pump.
⑥	Refrigerant charge base	—
⑦	Refrigerant cylinder	·Only for R410A
		·Top of cylinder (Pink) ·Cylinder with syphon
⑧	Refrigerant recovery equipment	—

2

PART NAMES AND FUNCTIONS

• Indoor unit

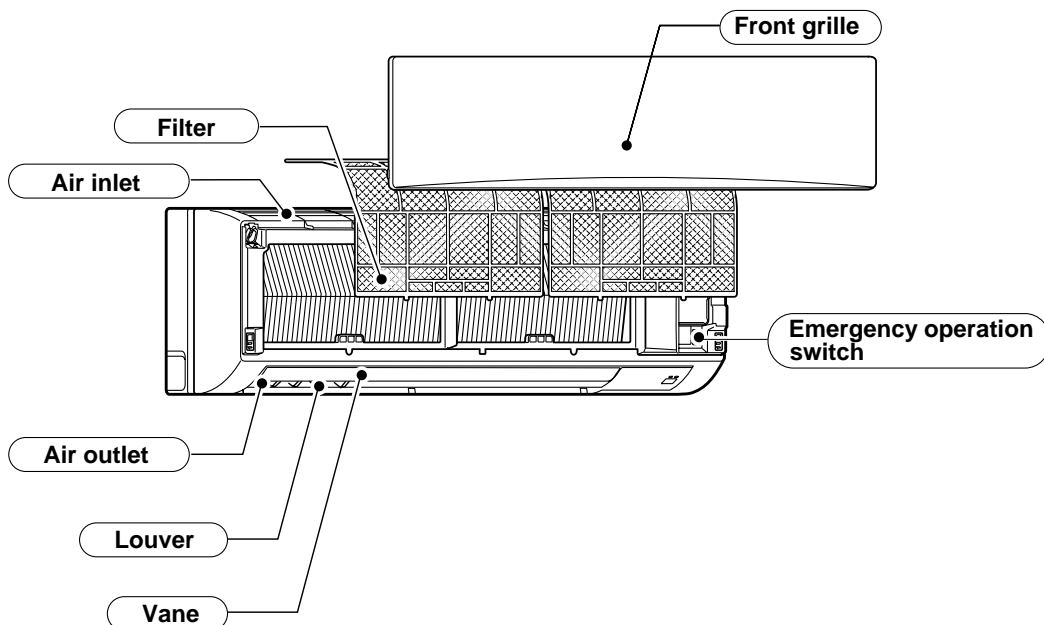

• Wired remote controller

Display Section

For purposes of this explanation, all parts of the display are shown as lit. During actual operation, only the relevant items will be lit.

Identifies the current operation
Shows the operating mode, etc.
*Multilanguage display is available.

"Centrally Controlled" indicator
Indicates that operation from the remote controller has been prohibited by a master controller.

"Timer is Off" indicator
Indicates that the timer is off.

Temperature Setting
Shows the target temperature.

Day-of-Week
Shows the current day of the week.

Time/Timer Display
Shows the current time, unless the simple or Auto Off timer is set.
If the simple or Auto Off timer is set, the time to be switched off is shown.

Up/Down Air Direction indicator
The indicator \ shows the direction of the outgoing airflow.

"One Hour Only" indicator
Displayed if the airflow is set to Low or downward during COOL or DRY mode. (Operation varies according to model.)
The indicator goes off in one hour, at which time the airflow direction also changes.

Room Temperature display
Shows the room temperature. The room temperature display range is 8–39°C. The display blinks if the temperature is less than 8°C or 39°C or more.

Louver display
Indicates the action of the swing louver. Does not appear if the louver is not running.

(Power On indicator)
Indicates that the power is on.

"Sensor" indication
Displayed when the remote controller sensor is used.

"Locked" indicator
Indicates that remote controller buttons have been locked.

"Clean The Filter" indicator
To be displayed on when it is time to clean the filter.

Timer indicators
The indicator comes on if the corresponding timer is set.

Fan Speed indicator
Shows the selected fan speed.

Ventilation indicator
Appears when the unit is running in Ventilation mode.

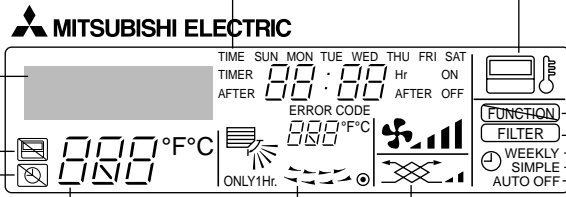

Operation Section

Temperature setting buttons

- ▽ Down
- △ Up

Timer Menu button (Monitor/Set button)

Mode button (Return button)

Set Time buttons

- ▽ Back
- △ Ahead

Timer On/Off button (Set Day button)

ON/OFF button

Fan Speed button

Filter button (<Enter> button)

Test Run button

Check button (Clear button)

Airflow Up/Down button

Louver button (▽ Operation button)

▽ To return operation number

Ventilation button (△ Operation button)

△ To go to next operation number

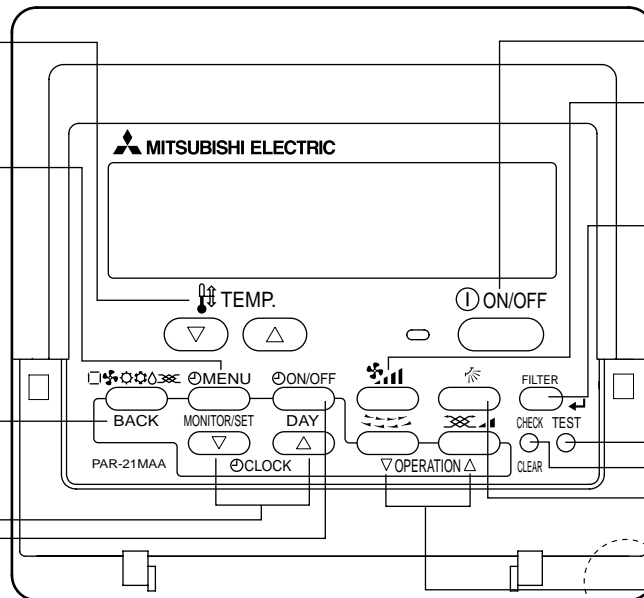

Built-in temperature sensor

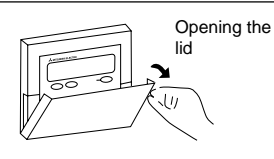

Note:

- "PLEASE WAIT" message
This message is displayed for approximately 3 minutes when power is supplied to the indoor unit or when the unit is recovering from a power failure.
- "NOT AVAILABLE" message
This message is displayed if an invalid button is pressed (to operate a function that the indoor unit does not have).
If a single remote controller is used to operate multiple indoor units simultaneously that are different types, this message will not be displayed as far as any of the indoor units is equipped with the function.

● **Wireless remote controller**

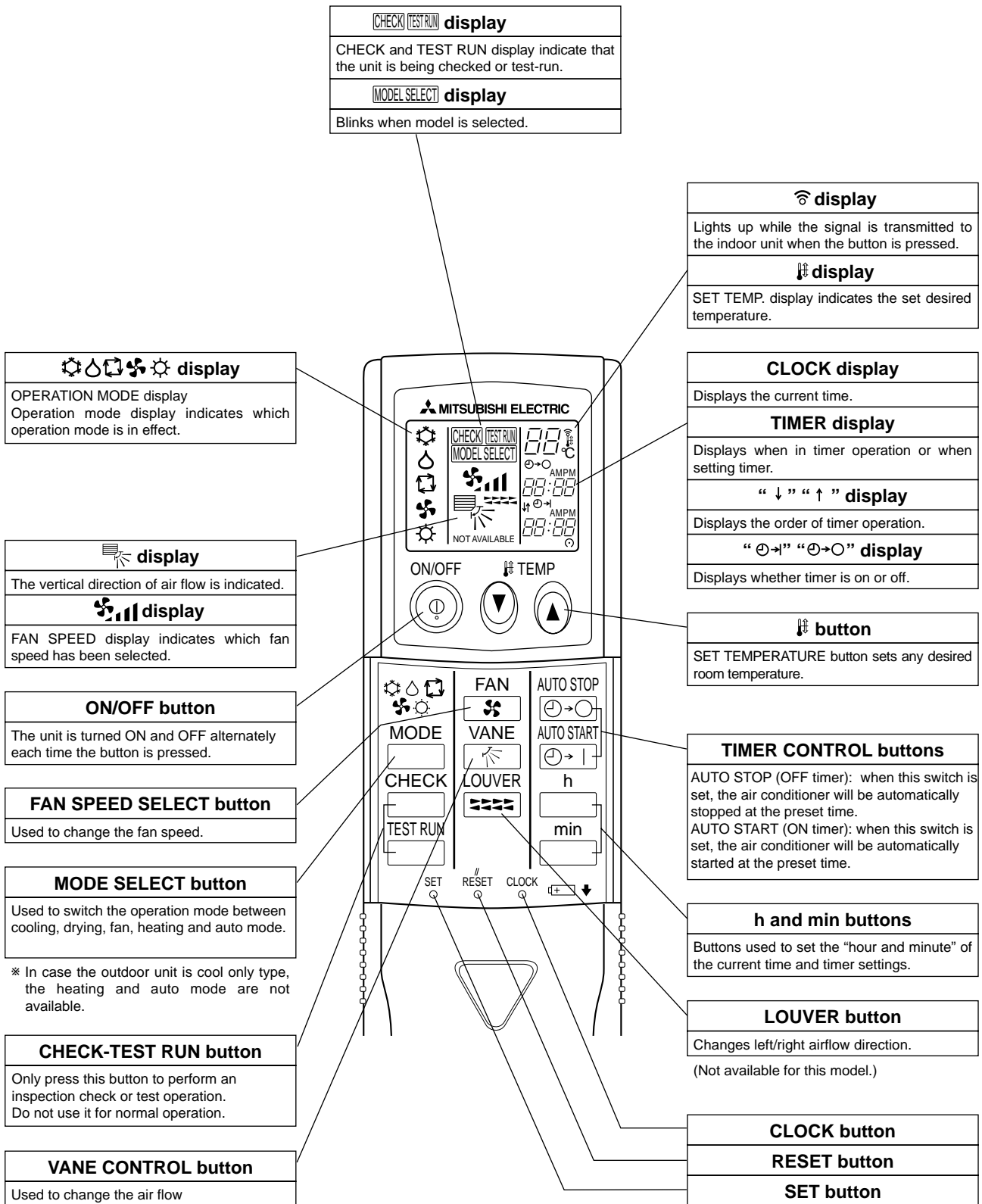

3-1. Specifications

Model		PKFY-P63VKM-E		PKFY-P100VKM-E		
Power source		1-phase 220-240V 50Hz, 1-phase 220V 60Hz				
Cooling capacity (Nominal)	*1	kW	7.1		11.2	
	*1	kcal/h	6,100		9,600	
	*1	Btu/h	24,200		38,200	
	*2	kcal/h	6,300		10,000	
		*4	kW	0.05		0.08
		*4	A	0.37	0.58	
Heating capacity (Nominal)	*3	kW	8.0		12.5	
	*3	kcal/h	6,900		10,800	
	*3	Btu/h	27,300		42,600	
		Power input	kW	0.04		0.07
		Current input	A	0.30		0.51
External finish		Plastic, MUNSELL (1.0Y 9.2/0.2)				
External dimension H x W x D		mm 365 x 1170 x 295 in. 14-3/8" x 46-1/16" x 11-5/8"				
Net weight		kg (lb) 21 (46)				
Heat exchanger		Cross fin (Aluminum fin and copper tube)				
Fan	Type x Quantity		Line flow fan x 1			
	External static press.	Pa	0			
		mmH ₂ O	0			
	Motor type		DC motor			
	Motor output		kW 0.056			
	Driving mechanism		Direct-drive			
	Airflow rate (Low-High)	m ³ /min		16 - 20	20 - 26	
L/s		267 - 333	333 - 433			
cfm		565 - 706	706 - 918			
Noise level (Low-High) (measured in anechoic room)		dB <A> 39 - 45		41 - 49		
Insulation material		Polyethylene sheet				
Air filter		PP honeycomb				
Protection device		Fuse				
Refrigerant control device		LEV				
Connectable outdoor unit		R410A, R407C, R22 CITY MULTI				
Diameter of refrigerant pipe	Liquid (R410A) (R22, R407C)	mm (in.)	ø9.52 (ø3/8") Flare	ø9.52 (ø3/8") Flare		
			ø9.52 (ø3/8") Flare	ø9.52 (ø3/8") Flare		
	Gas (R410A) (R22, R407C)	mm (in.)	ø15.88 (ø5/8") Flare	ø15.88 (ø5/8") Flare		
			ø15.88 (ø5/8") Flare	ø19.03 (ø3/4") Flare		
Field drain pipe size		mm (in.) I.D. 16mm (5/8")				
Standard attachment		Document Accessory Installation Manual, Instruction Book				
Optional parts		Drain pump kit PAC-SH94DM-E				
Remark						
Installation		Details on foundation work, insulation work, electrical wiring, power source switch, and other items shall be referred to the Installation Manual.				
Note :		*1 Nominal cooling conditions	*2 Nominal cooling conditions	*3 Nominal heating conditions	Unit converter	
Indoor :		27°CDB/19°CWB (81°FDB/66°FWB)	27°CDB/19.5°CWB (81°FDB/67°FWB)	20°CDB (68°FDB)	kcal/h = kW x 860	
Outdoor :		35°CDB (95°FDB)	35°CDB (95°FDB)	7°CDB/6°CWB (45°FDB/43°FWB)	Btu/h = kW x 3,412	
Pipe length :		7.5 m (24-9/16 ft)	5 m (16-3/8 ft)	7.5 m (24-9/16 ft)	cfm = m ³ /min x 35.31	
Level difference :		0 m (0 ft)	0 m (0 ft)	0 m (0 ft)	lb = kg/0.4536	
					*Above specification data is subject to rounding variation.	
*4 Electrical characteristic of cooling are included optional drain - pump.						
* Nominal conditions *1, *3 are subject to JIS B8615-1.						
* Due to continuing improvement, above specification may be subject to change without notice.						



3-2. Electrical parts specifications

Service Ref. Parts name	Symbol	PKFY-P63VKM-E.TH	PKFY-P100VKM-E.TH
Room temperature thermistor	TH21	Resistance 0°C/15kΩ, 10°C/9.6kΩ, 20°C/6.3kΩ, 25°C/5.4kΩ, 30°C/4.3kΩ, 40°C/3.0kΩ	
Liquid pipe thermistor	TH22	Resistance 0°C/15kΩ, 10°C/9.6kΩ, 20°C/6.3kΩ, 25°C/5.4kΩ, 30°C/4.3kΩ, 40°C/3.0kΩ	
Gas pipe thermistor	TH23 TH24	Resistance 0°C/15kΩ, 10°C/9.6kΩ, 20°C/6.3kΩ, 25°C/5.4kΩ, 30°C/4.3kΩ, 40°C/3.0kΩ	
Fuse (Indoor controller board)	FUSE	250V 3.15A	
Fan motor	MF	8-Pole Output 56W / RCOJ56-AC	
Vane motor	MV	MSBPC20 DC12V	
Linear expansion valve	LEV	EFM-40YGME DC 12 V	EFM-80YGME DC 12 V
Power supply terminal block	TB2	(L, N, ⊕) 250V 20A	
Transmission terminal block	TB5	(M1, M2, S) 250V 20A	
MA remote controller terminal block	TB15	(1, 2) 250V 10A	

3-3. Sound levels

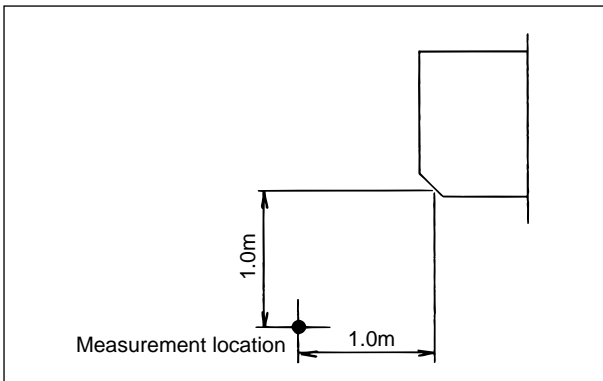

Sound level at anechoic room : Low-High

	Sound level dB (A)
PKFY-P63VKM-E	39 - 45
PKFY-P100VKM-E	41 - 49

* Measured in anechoic room.

3-4. NC curves

PKFY-P63VKM-E

External static pressure : 0Pa

Power source : 220, 230, 240V, 50Hz/220V, 60Hz

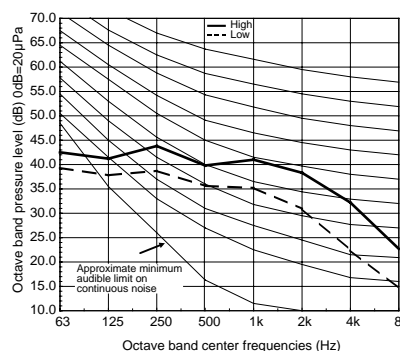

PKFY-P100VKM-E

External static pressure : 0Pa

Power source : 220, 230, 240V, 50Hz/220V, 60Hz

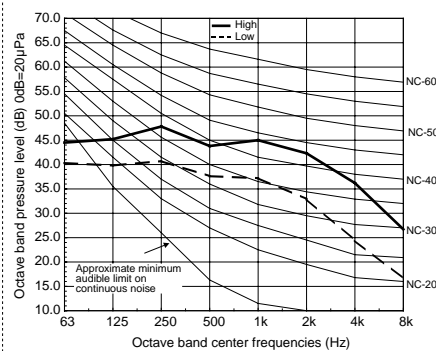

PKFY-P63VKM-E.TH PKYF-P100VKM-E.TH

Unit : mm

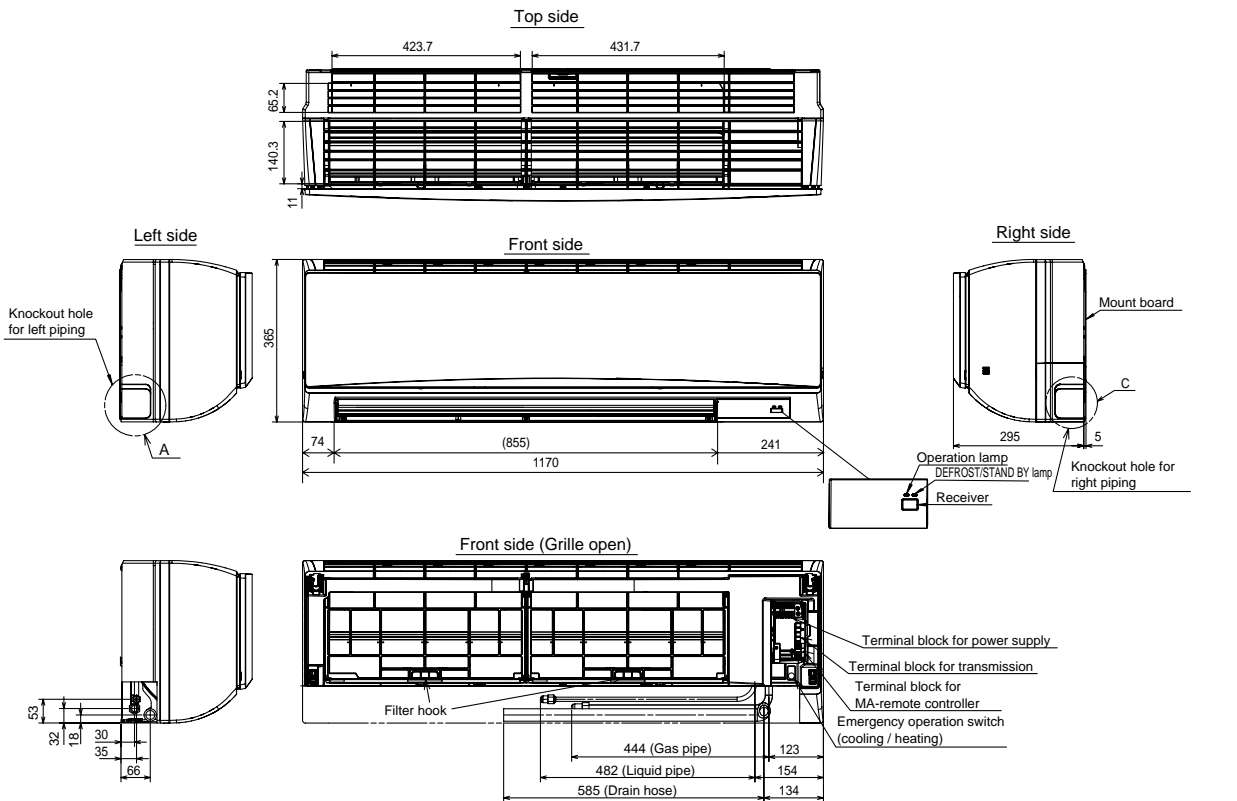

Piping connection department

① Liquid pipe	Refrigerant pipe : $\phi 9.52$ Flared connection : 3/8F
② Gas pipe	Refrigerant pipe : $\phi 15.88$ Flared connection : 5/8F
③ Drain hose	$\phi 16$ O.D

Sleeve (purchased locally)	Through hole
$\phi 75$	$\phi 75 \sim \phi 80$

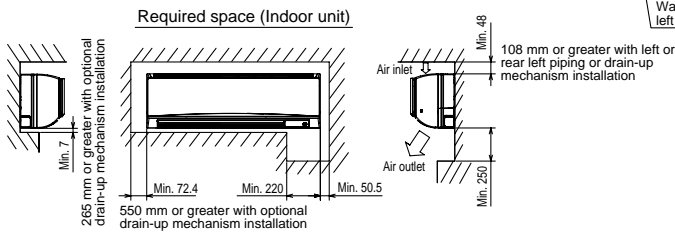
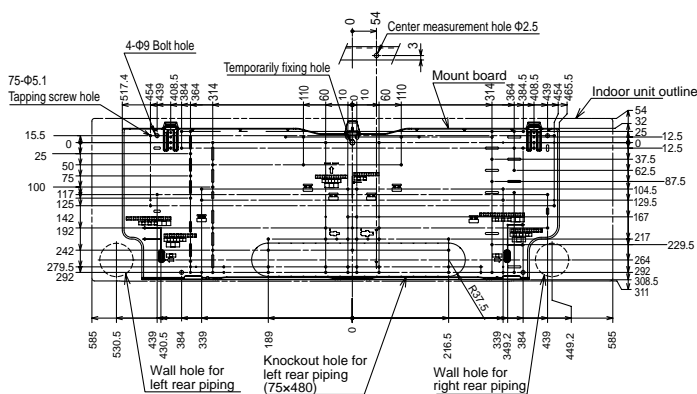
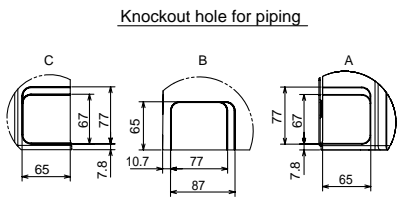
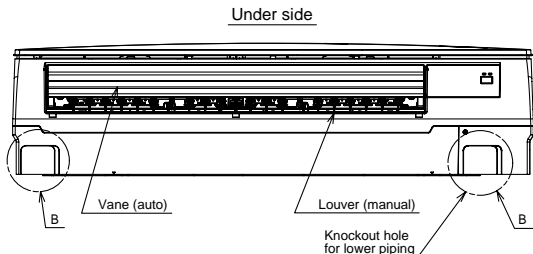

PKFY-P63VKM-E.TH PKYF-P100VKM-E.TH

SYMBOL	NAME	SYMBOL	NAME
I.B	INDOOR CONTROLLER BOARD	TH21	THERMISTOR ROOM TEMP. DETECTION (0°C/15kΩ, 25°C/5.4kΩ)
CN32	CONNECTOR REMOTE SWITCH	TH22	PIPE TEMP. DETECTION/LIQUID (0°C/15kΩ, 25°C/5.4kΩ)
CN51	CENTRALLY CONTROL	TH23	PIPE TEMP. DETECTION/GAS1 (0°C/15kΩ, 25°C/5.4kΩ)
CN52	REMOTE INDICATION	TH24	PIPE TEMP. DETECTION/GAS2 (0°C/15kΩ, 25°C/5.4kΩ)
BZ	BUZZER	A.B	ADDRESS BOARD
DSA	SURGE ABSORBER	SWA	SWITCH FAN SPEED SELECTOR
FUSE	FUSE (T3.15AL 250V)	SW1	MODE SELECTION
LED1	POWER SUPPLY (I.B)	SW11	ADDRESS SETTING 1s DIGIT
LED2	POWER SUPPLY (I.B)	SW12	ADDRESS SETTING 10ths DIGIT
SW2	SWITCH CAPACITY CODE	SW14	BRANCH No.
SW3	MODE SELECTION	S.B	SWITCH BOARD
SW4	MODEL SELECTION	SWE1	EMERGENCY OPERATION (HEAT)
SWE	DRAIN PUMP (TEST MODE)	SWE2	EMERGENCY OPERATION (COOL)
X1	AUX.RELAY DRAIN PUMP (OPTION)	W.B	PCB FOR WIRELESS REMOTE CONTROLLER
MOV 01.02	VARISTOR	LED1	LED (OPERATION INDICATOR: GREEN)
LEV	LINEAR EXPANSION VALVE	LED2	LED (OPERATION FOR HEATING: ORANGE)
MF	FAN MOTOR	RU	RECEIVING UNIT
MV	VANE MOTOR	DP	DRAIN PUMP (OPTION)
TB2	TERMINAL POWER SUPPLY	FS	DRAIN FLOAT SWITCH (OPTION)
TB5	BLOCK TRANSMISSION		
TB15	BLOCK MA-REMOTE CONTROLLER		

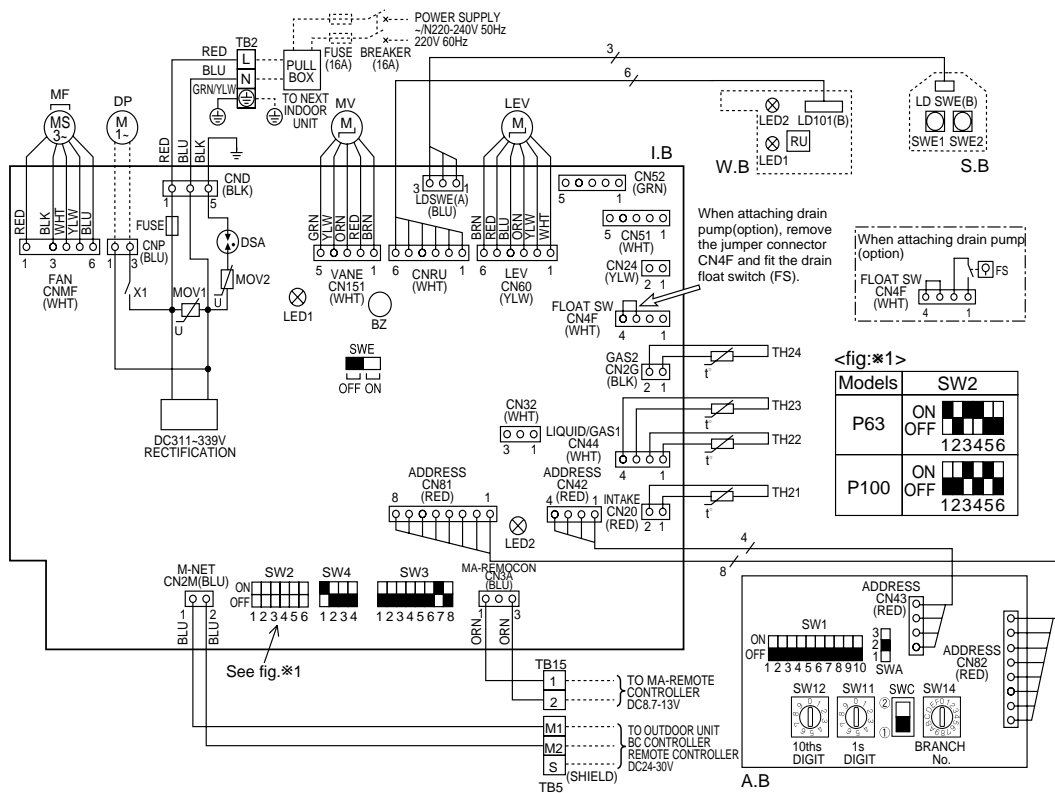

LED on indoor board for service

Mark	Meaning	Function
LED1	Main power supply	Main power supply (Indoor unit:220-240V) Power on → lamp is lit
LED2	Power supply for MA-Remote controller	Power supply for MA-Remote controller on → lamp is lit

NOTES:

- At servicing for outdoor unit, always follow the wiring diagram of outdoor unit.
- In case of using MA-Remote controller, please connect to TB15. (Remote controller wire is non-polar.)
- In case of using M-NET, please connect to TB5. (Transmission line is non-polar.)
- Symbol [S] of TB5 is the shield wire connection.
- Symbols used in wiring diagram above are, : terminal block, :connector.
- The setting of the SW2 dip switches differs in the capacity. For the detail, refer to fig.*1.

6

REFRIGERANT SYSTEM DIAGRAM

PKFY-P63VKM-E.TH
PKFY-P100VKM-E.TH

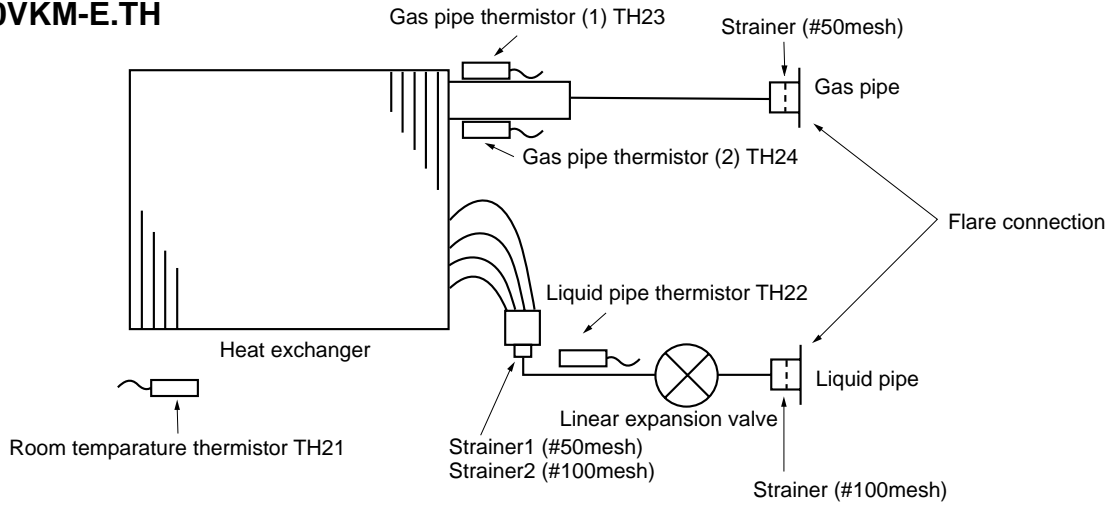

Unit : mm (inch)

Item \ Model	PKFY-P63VKM-E	PKFY-P100VKM-E
Gas pipe	φ15.88 (5/8)	φ15.88 (5/8)
Liquid pipe	φ9.52 (3/8)	φ9.52 (3/8)

7

TROUBLESHOOTING

7-1. HOW TO CHECK THE PARTS

PKFY-P63VKM-E.TH PKFY-P100VKM-E.TH

Parts name	Check points														
Room temperature thermistor (TH21) Liquid pipe temperature thermistor (TH22) Gas pipe temperature thermistor (TH23, 24)	Disconnect the connector then measure the resistance using a tester. (At the ambient temperature 10°C ~30°C) <table border="1" style="margin-left: 20px;"> <thead> <tr> <th>Normal</th> <th>Abnormal</th> </tr> </thead> <tbody> <tr> <td>4.3kΩ~9.6kΩ</td> <td>Open or short</td> </tr> </tbody> </table> Refer to the next page for the details.	Normal	Abnormal	4.3kΩ~9.6kΩ	Open or short										
Normal	Abnormal														
4.3kΩ~9.6kΩ	Open or short														
Vane motor (MV)	Measure the resistance between the terminals using a tester. (Coil temperature 20°C) <table border="1" style="margin-left: 20px;"> <thead> <tr> <th colspan="4">Normal</th> <th>Abnormal</th> </tr> </thead> <tbody> <tr> <td>①-② Brown-Red</td> <td>①-③ Brown-Orange</td> <td>①-④ Brown-Yellow</td> <td>①-⑤ Brown-Green</td> <td rowspan="2">Open or short</td> </tr> <tr> <td colspan="4" style="text-align: center;">250Ω ± 7%</td> </tr> </tbody> </table>	Normal				Abnormal	①-② Brown-Red	①-③ Brown-Orange	①-④ Brown-Yellow	①-⑤ Brown-Green	Open or short	250Ω ± 7%			
Normal				Abnormal											
①-② Brown-Red	①-③ Brown-Orange	①-④ Brown-Yellow	①-⑤ Brown-Green	Open or short											
250Ω ± 7%															
Fan motor (MF)	Refer to 7-1-3.														
Linear expansion valve (LEV)	Disconnect the connector then measure the resistance valve using a tester. (Coil temperature 20°C) <table border="1" style="margin-left: 20px;"> <thead> <tr> <th colspan="4">Normal</th> <th>Abnormal</th> </tr> </thead> <tbody> <tr> <td>(1)-(5) White-Red</td> <td>(2)-(6) Yellow-Brown</td> <td>(3)-(5) Orange-Red</td> <td>(4)-(6) Blue-Brown</td> <td rowspan="2">Open or short</td> </tr> <tr> <td colspan="4" style="text-align: center;">200Ω ± 10%</td> </tr> </tbody> </table>	Normal				Abnormal	(1)-(5) White-Red	(2)-(6) Yellow-Brown	(3)-(5) Orange-Red	(4)-(6) Blue-Brown	Open or short	200Ω ± 10%			
Normal				Abnormal											
(1)-(5) White-Red	(2)-(6) Yellow-Brown	(3)-(5) Orange-Red	(4)-(6) Blue-Brown	Open or short											
200Ω ± 10%															

7-1-1. Thermistor

<Thermistor Characteristic graph>

Thermistor for lower temperature

Room temperature thermistor (TH21)
Liquid pipe temperature thermistor (TH22)
Gas pipe temperature thermistor (TH23)
(TH24)

Thermistor $R_0=15k\Omega \pm 3\%$
Fixed number of $B=3480 \pm 2\%$

$$R_t = 15 \exp \left\{ 3480 \left(\frac{1}{273+t} - \frac{1}{273} \right) \right\}$$

0°C	15kΩ
10°C	9.6kΩ
20°C	6.3kΩ
25°C	5.4kΩ
30°C	4.3kΩ
40°C	3.0kΩ

< Thermistor for lower temperature >

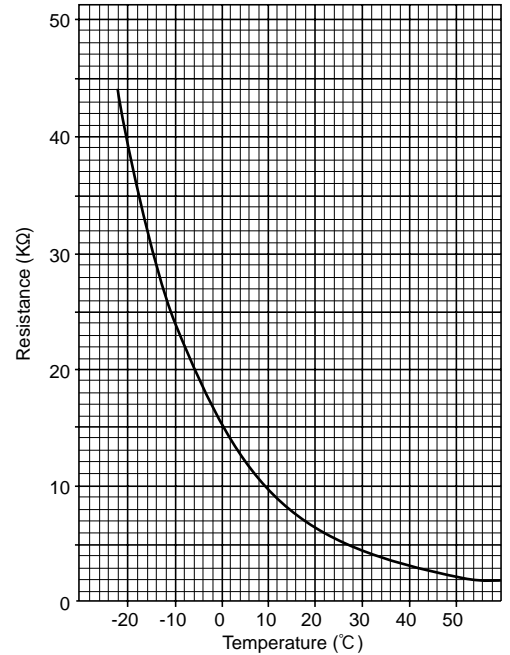

7-1-2. Linear expansion valve

① Operation summary of the linear expansion valve

- Linear expansion valve opens/closes through stepping motor after receiving the pulse signal from the indoor controller board.
- Valve position can be changed in proportion to the number of pulse signal.

<Connection between the indoor controller board and the linear expansion valve>

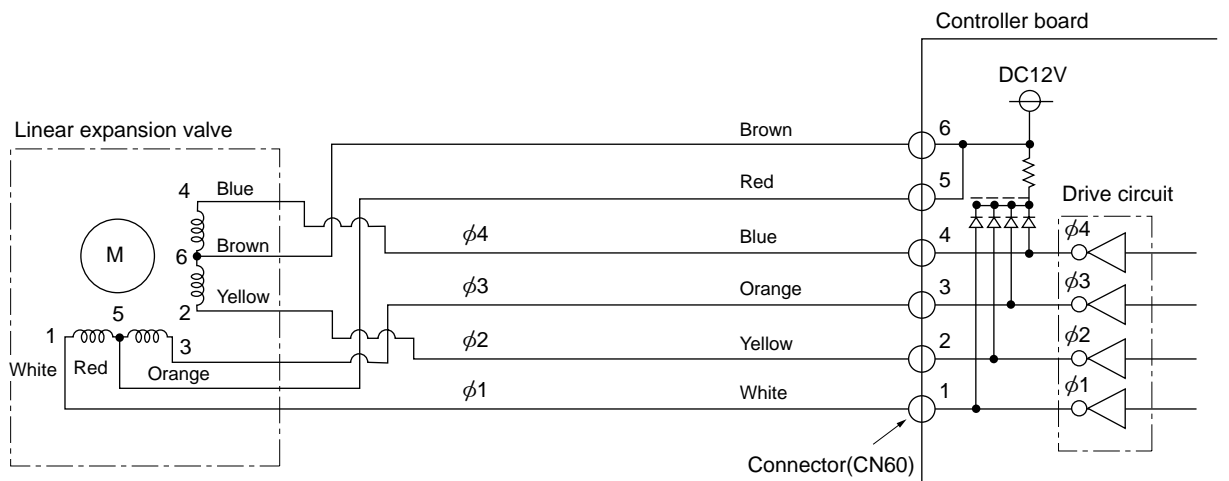

Note : Since the number of the connector at the controller board side and the relay connector are different, follow the color of the lead wire.

<Output pulse signal and the valve operation>

Output (Phase)	Output			
	1	2	3	4
φ1	ON	OFF	OFF	ON
φ2	ON	ON	OFF	OFF
φ3	OFF	ON	ON	OFF
φ4	OFF	OFF	ON	ON

Closing a valve : 1 → 2 → 3 → 4 → 1
 Opening a valve : 4 → 3 → 2 → 1 → 4
 The output pulse shifts in above order.

- When linear expansion valve operation stops, all output phase become OFF.
- At phase interruption or when phase does not shift in order, motor does not rotate smoothly and motor will lock and vibrate.
- When the switch is turned on, 2200 pulse closing valve signal will be sent till it goes to point ㉞ in order to define the valve position.
- When the valve moves smoothly, there is no noise or vibration occurring from the linear expansion valves : however, when the pulse number moves from ㉞ to ㉞ or when the valve is locked, more noise can be heard than in a normal situation.
- Noise can be detected by placing the ear against the screw driver handle while putting the screw driver tip to the linear expansion valve.

② Linear expansion valve operation

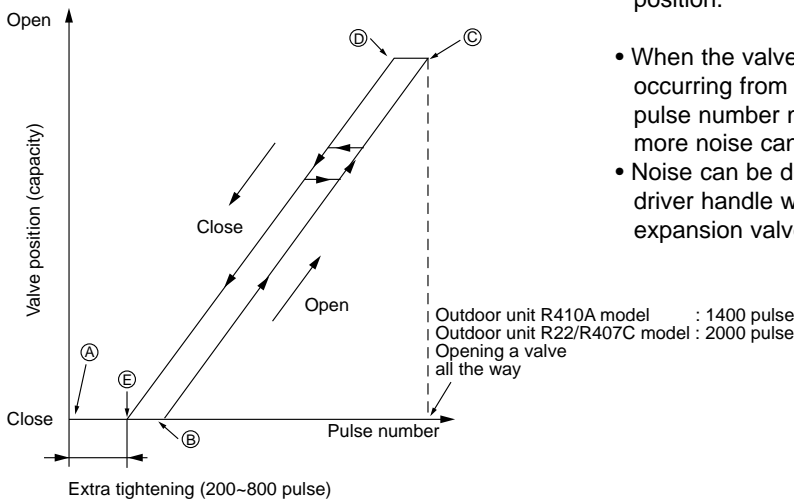

③ Trouble shooting

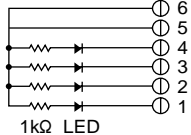
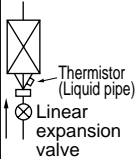
Symptom	Check points	Countermeasures
Operation circuit failure of the micro processor	Disconnect the connector on the controller board, then connect LED for checking.  When power is turned on, pulse signals will output for 10 seconds. There must be some defects in the operation circuit if the LED does not light while the signals are output or keeps lighting even after the signals stop.	Exchange the indoor controller board in case of drive circuit failure.
Linear expansion valve mechanism is locked.	Motor will idle and make a ticking noise when the motor is operated while the linear expansion valve is locked. This ticking sound is the sign of the abnormality.	Exchange the linear expansion valve.
Short or breakage of the motor coil of the linear expansion valve	Measure the resistance between each coil (white-red, yellow-brown, orange-red, blue-brown) using a tester. It is normal if the resistance is in the range of 200Ω ±10%.	Exchange the linear expansion valve.
Valve does not close completely.	To check the linear expansion valve, operate the indoor unit in fan mode and at the same time operate other indoor units in cooling mode, then check the pipe temperature <liquid pipe temperature> of the indoor unit by the outdoor multi controller board operation monitor. During fan operation, linear expansion valve is closed completely and if there is any leaking, detecting temperature of the thermistor will go lower. If the detected temperature is much lower than the temperature indicated in the remote controller, it means the valve is not closed all the way.  It is not necessary to exchange the linear expansion valve, if the leakage is small and not affecting normal operation.	If large amount of refrigerant is leaked, exchange the linear expansion valve.
Wrong connection of the connector or contact failure	Check the color of lead wire and missing terminal of the connector.	Disconnect the connector at the controller board, then check the continuity.



7-1-3. DC Fan motor (fan motor/indoor controller circuit board)

Check method of DC fan motor (fan motor/indoor controller circuit board)

① Notes

- High voltage is applied to the connector (CNMF) for the fan motor. Pay attention to the service.
- Do not pull out the connector (CNMF) for the motor with the power supply on.
(It causes trouble of the indoor controller circuit board and fan motor.)

② Self check

Symptom : The indoor fan cannot turn around.

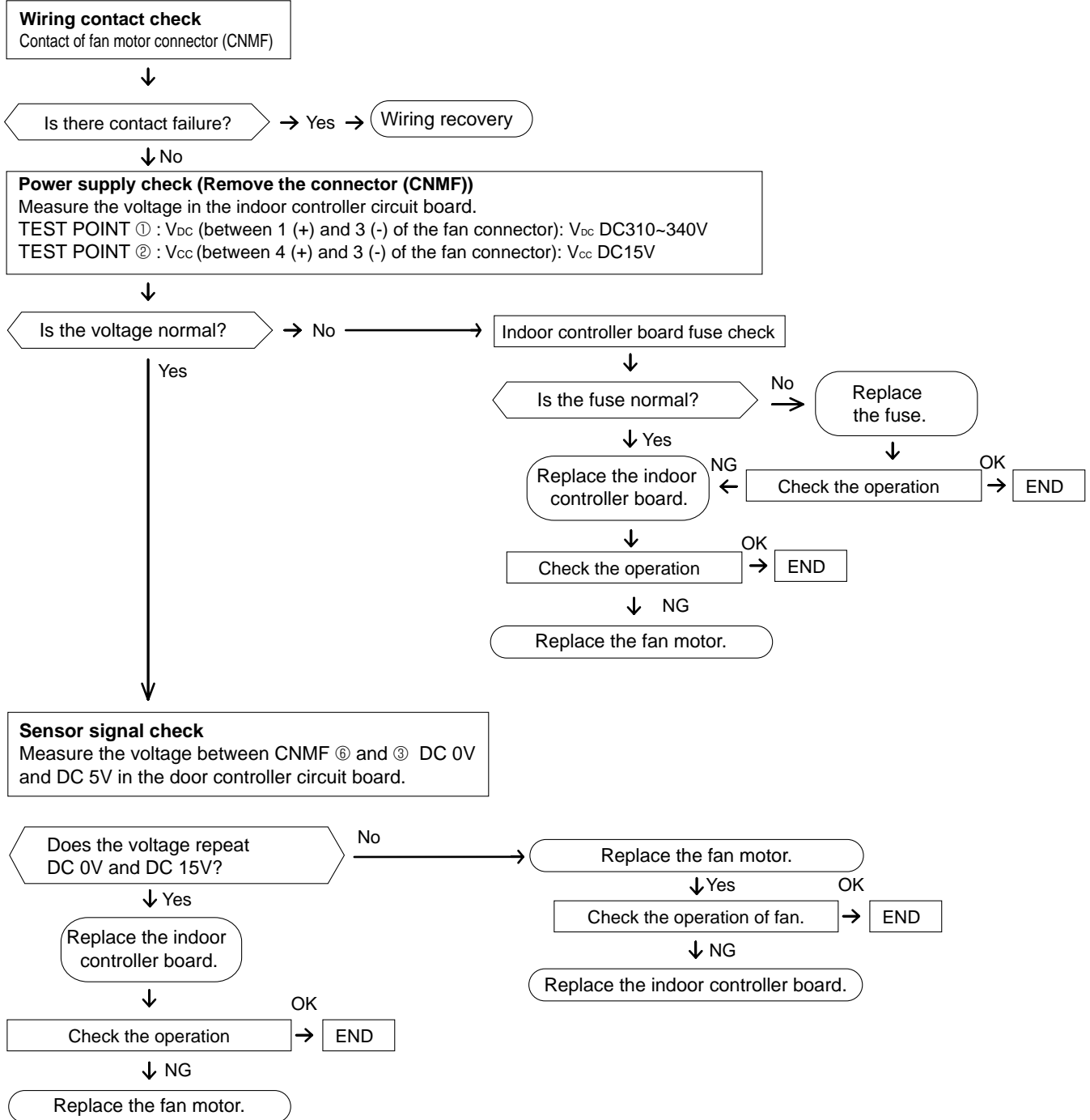

7-2. Function of Dip switch

PKFY-P63VKM-E.TH PKFY-P100VKM-E.TH

Switch	Pole	Function	Operation by switch		Effective timing	Remarks															
			ON	OFF																	
SW1 Mode selection	1	Thermistor<Room temperature> position	Built-in remote controller	Indoor unit	Under suspension	<div style="border: 1px solid black; padding: 5px; margin-bottom: 5px;">Address board</div> <div style="margin-bottom: 5px;"><Initial setting></div> <div style="margin-bottom: 5px;"> </div> <div style="margin-bottom: 5px;">NOTE: *1</div> <table border="1" style="font-size: small; border-collapse: collapse; width: 100%;"> <tr> <td>SW1-7</td> <td>SW1-8</td> <td>Fan speed</td> </tr> <tr> <td>OFF</td> <td>OFF</td> <td>Extra low</td> </tr> <tr> <td>ON</td> <td>OFF</td> <td>Low</td> </tr> <tr> <td>OFF</td> <td>ON</td> <td>Setting air flow</td> </tr> <tr> <td>ON</td> <td>ON</td> <td>Stop</td> </tr> </table> <div style="margin-top: 5px;">*2 It is impossible to intake the fresh air.</div>	SW1-7	SW1-8	Fan speed	OFF	OFF	Extra low	ON	OFF	Low	OFF	ON	Setting air flow	ON	ON	Stop
	SW1-7	SW1-8	Fan speed																		
	OFF	OFF	Extra low																		
	ON	OFF	Low																		
	OFF	ON	Setting air flow																		
	ON	ON	Stop																		
	2	Filter clogging detection	Provide	Not provide																	
	3	Filter cleaning sign	2,500 hr	100 hr																	
	4	Frashair intake *2	Not effective	Not effective																	
	5	Switching remote controller display	Thermo ON signal indication	Fan output indication																	
6	Humidifier control	Fan operation at Heating mode	Thermo ON operation at heating mode																		
7	Air flow set in case of heat thermo OFF	Low *1	Extra low *1																		
8		Setting air flow *1	Depends on SW1-7																		
9	Auto restart function	Effective	Not effective																		
10	Power ON/OFF by breaker	Effective	Not effective																		
SW2 Capacity code switch	1~6			Before power supply ON	<div style="border: 1px solid black; padding: 5px; margin-bottom: 5px;">Indoor controller board</div> <div style="margin-bottom: 5px;"><Initial setting></div> <div style="margin-bottom: 5px;">Set for each capacity</div>																
SW3 Function selection	1	Heat pump/Cool only	Cooling only	Heat pump	Under suspension	<div style="border: 1px solid black; padding: 5px; margin-bottom: 5px;">Indoor controller board</div> <div style="margin-bottom: 5px;"><Initial setting></div> <div style="margin-bottom: 5px;"> </div> <div style="margin-bottom: 5px;">*1 Second setting is same as first setting. *2 Please do not use SW3-7,8 as trouble might be caused by the usage condition.</div>															
	2	Not used	—	—																	
	3	Not used	—	—																	
	4	Vane horizontal angle	Second setting *1	First setting																	
	5	Changing the opening of linear expansion valve during thermo OFF	Effective	Not effective																	
	6	Heating 4 degree up	Not effective	Effective																	
	7	Target superheat setting*2	—	—																	
	8	Target subcool *2	—	—																	
SW4 Model Select	1~4	ON OFF		Before power supply ON	<div style="border: 1px solid black; padding: 5px; margin-bottom: 5px;">Indoor controller board</div>																
SW11 1s digit address setting SW12 10ths digit address setting	Rotary switch	<p>How to set addresses Example : If address is "3", remain SW12 (for over 10) at "0", and match SW11 (for 1 to 9) with "3".</p>		Before power supply ON	<div style="border: 1px solid black; padding: 5px; margin-bottom: 5px;">Address board</div> <div style="margin-bottom: 5px;"><Initial setting></div> <div style="margin-bottom: 5px;"> </div>																
SW14 Branch No. Setting	Rotary switch	<p>How to set branch numbers SW14 (Series R2 only) Match the indoor unit's refrigerant pipe with the BC controller's end connection number. Remain other than series R2 at "0".</p>			<div style="border: 1px solid black; padding: 5px; margin-bottom: 5px;">Address board</div> <div style="margin-bottom: 5px;"><Initial setting></div> <div style="margin-bottom: 5px;"> </div>																

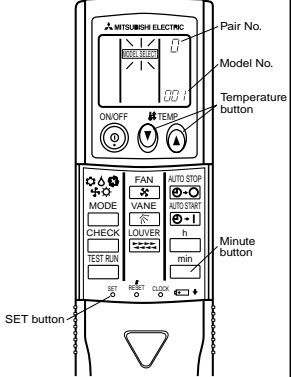
Switch	Operation by switch	Effective timing	Remarks																											
J41, J42 Wireless remote controller Pair No.	<p style="text-align: center;">Jumper</p> <ul style="list-style-type: none"> To operate each indoor unit by each remote controller when installed 2 indoor units or more are near, Pair No. setting is necessary. <ul style="list-style-type: none"> Pair No. setting is available with the 4 patterns (Setting patterns A to D). Make setting for J41, J42 of indoor controller board and the Pair No. of wireless remote controller. You may not set it when operating it by one remote controller. <ul style="list-style-type: none"> Setting for indoor unit <ul style="list-style-type: none"> Cut jumper wire J41, J42 on the indoor controller board according to the table below. Wireless remote controller pair number: <ul style="list-style-type: none"> Setting operation <ol style="list-style-type: none"> Press the SET button (using a pointed implement). Check that the remote controller's display has stopped before continuing. MODEL SELECT flashes, and the model No. (3 digits) appears (steadily-lit). Press the MINUTE button twice. The pair number appears flashing. Press the temperature (M) (A) buttons to select the pair number to set. Press the SET button (using a pointed implement). The set pair number is displayed (steadily-lit) for 3 seconds, then disappears. <table border="1" data-bbox="352 797 1034 999" style="width: 100%; border-collapse: collapse; text-align: center;"> <thead> <tr> <th rowspan="2">Setting pattern</th> <th colspan="2">Indoor controller jumper wire</th> <th rowspan="2">Pair No. of wireless remote controller*</th> <th rowspan="2"></th> </tr> <tr> <th>J41</th> <th>J42</th> </tr> </thead> <tbody> <tr> <td>A</td> <td>—</td> <td>—</td> <td>0</td> <td>Initial setting</td> </tr> <tr> <td>B</td> <td>Cut</td> <td>—</td> <td>1</td> <td>—</td> </tr> <tr> <td>C</td> <td>—</td> <td>Cut</td> <td>2</td> <td>—</td> </tr> <tr> <td>D</td> <td>Cut</td> <td>Cut</td> <td>3</td> <td>—</td> </tr> </tbody> </table> <p style="font-size: small;">* Pair No.4-9 of wireless remote controller is setting pattern D.</p>	Setting pattern	Indoor controller jumper wire		Pair No. of wireless remote controller*		J41	J42	A	—	—	0	Initial setting	B	Cut	—	1	—	C	—	Cut	2	—	D	Cut	Cut	3	—	Under operation or suspension	<p style="text-align: center;"><Initial setting> Pattern A</p>  <p>The diagram shows a Mitsubishi Electric remote controller. Labels point to the following features: Pair No. (displayed as '00'), Model No. (displayed as '000'), Temperature button (M and A symbols), Minute button (MINUTE), and SET button (bottom center).</p>
Setting pattern	Indoor controller jumper wire		Pair No. of wireless remote controller*																											
	J41	J42																												
A	—	—	0	Initial setting																										
B	Cut	—	1	—																										
C	—	Cut	2	—																										
D	Cut	Cut	3	—																										

7-3. TEST POINT DIAGRAM

7-3-1. Indoor controller board

PKFY-P63VKM-E.TH

PKFY-P100VKM-E.TH

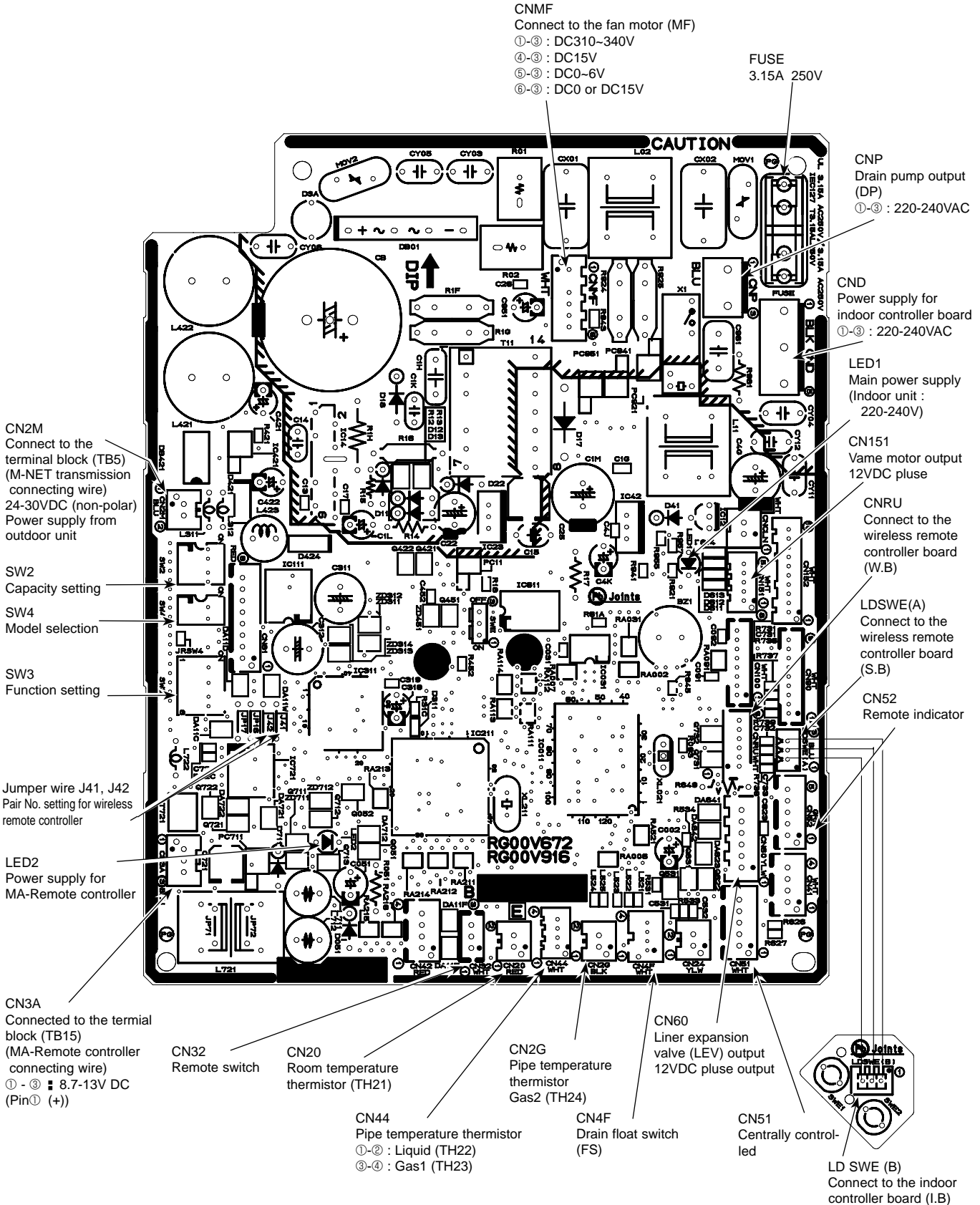

7-3-2. Wireless remote controller board
PKFY-P63VKM-E.TH
PKFY-P100VKM-E.TH

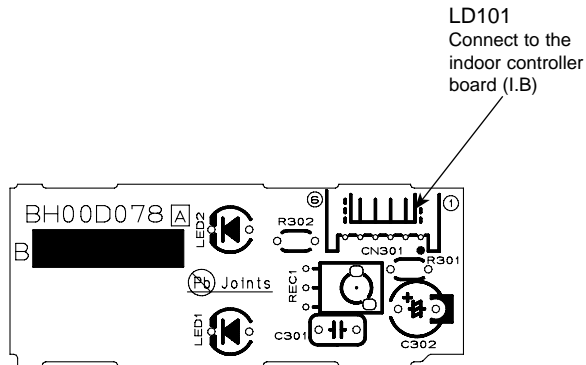

7-3-3. Address board
PKFY-P63VKM-E.TH
PKFY-P100VKM-E.TH

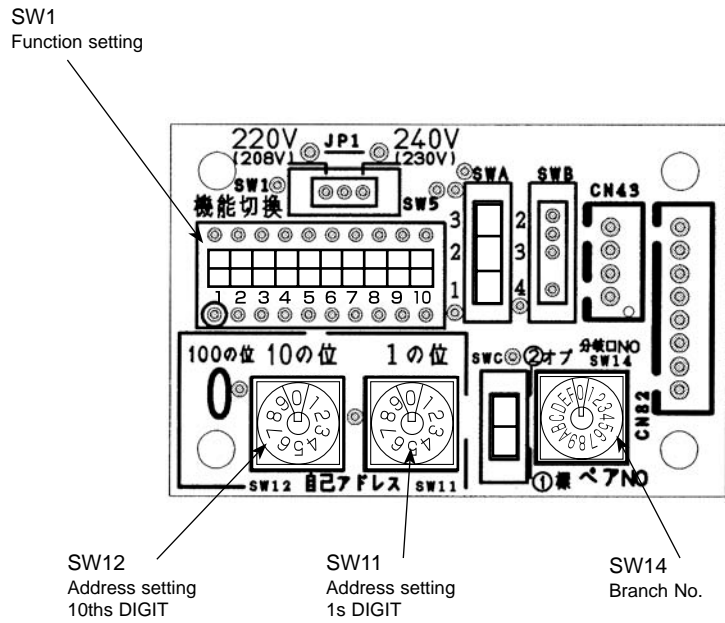

PKFY-P63VKM-E.TH PKFY-P100VKM-E.TH

Be careful when removing heavy parts.

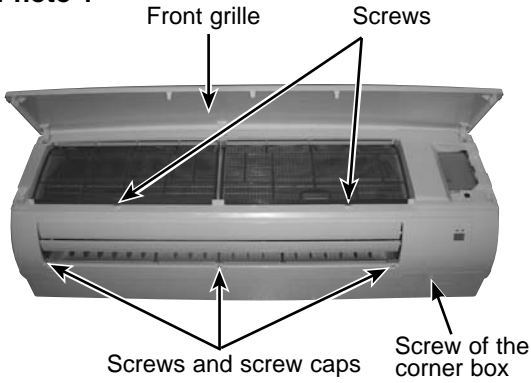
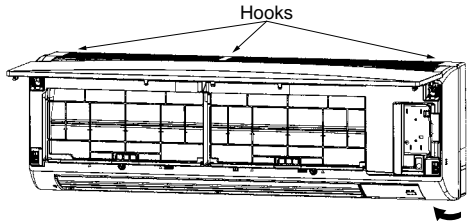
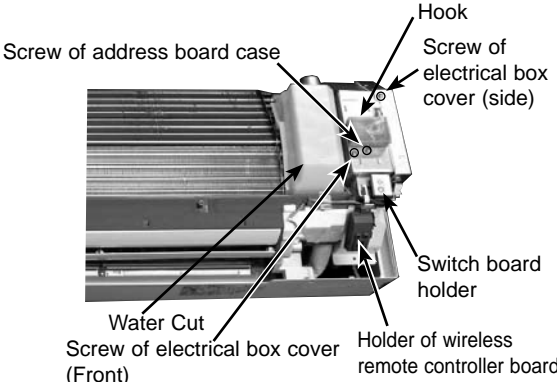
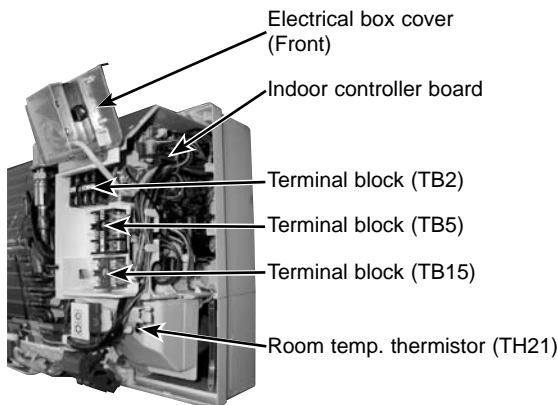
OPERATION PROCEDURE	PHOTOS & ILLUSTRATIONS
<p>1. REMOVING THE PANEL</p> <ol style="list-style-type: none"> (1) Press and unlock the knobs on both sides of the front grille and lift the front grille until it is level. Pull the hinges forward to remove the front grille. (See Photo 1) (2) Remove 3 screw caps of the panel. Remove 5 screws. (See Photo 1) (3) Unfix 3 hooks. (See Figure 1) (4) Hold the lower part of both ends of the panel and pull it slightly toward you, and then remove the panel by pushing it upward. (5) Remove the screw of the corner box. (See Photo 1) Remove the corner box. 	<p>Photo 1</p>  <p>Figure 1</p> 
<p>2. REMOVING THE ADDRESS BOARD, THE INDOOR CONTROLLER BOARD, THE WIRELESS CONTROLLER BOARD</p> <ol style="list-style-type: none"> (1) Remove the panel and the corner box. (Refer to 1.) (2) Remove the screw and hook of address board case. (See Photo 2) (3) Disconnect the connectors of address board. (4) Remove the front and side electrical box covers (each 1 screw). (5) Disconnect the connectors on the indoor controller board. (See Photo 3) (6) Remove the switch board holder and open the cover. (7) Pull out the indoor controller board toward you then remove the indoor controller board and switch board. (See Photo 3) (8) Remove the holder of wireless remote controller board. (9) Disconnect the connector of wireless remote controller board and remove the wireless remote controller board from the holder. 	<p>Photo 2</p>  <p>Photo 3</p> 



OPERATION PROCEDURE

6. REMOVING THE INDOOR FAN MOTOR AND THE LINE FLOW FAN

- (1) Remove the panel and the corner box. (Refer to 1.)
- (2) Remove the electrical box (Refer to 2.) and the nozzle assembly (Refer to 3.).
- (3) Remove the water cut. (See Photo 2)
- (4) Remove the screw fixing the line flow fan. (See Photo 8)
- (5) Remove 5 screws fixing the motor bed. (See Photo 7)
- (6) Remove the lead wire of pipe thermistor from the hook of motor bed. (See Photo 7)
- (7) Remove the screw fixing motor band. (See Photo 7)
- (8) Remove the motor bed together with fan motor and motor band.
- (9) Remove 3 screws fixing the left side of the heat exchanger. (See Photo 9)
- (10) Lift the heat exchanger, and pull out the line flow fan to the lower-left.

Photo 9

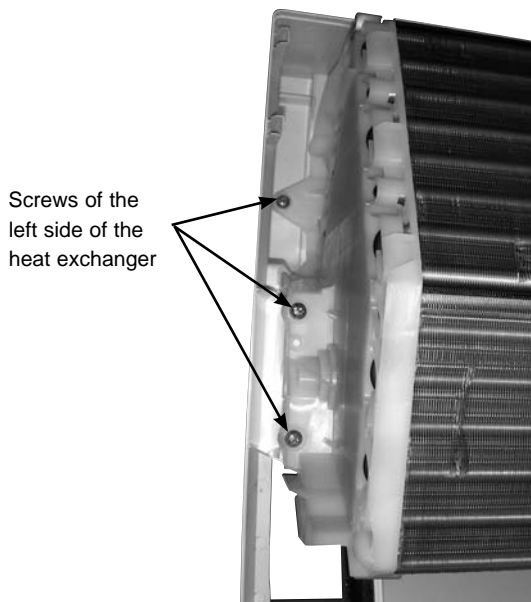

PHOTOS

Photo 7

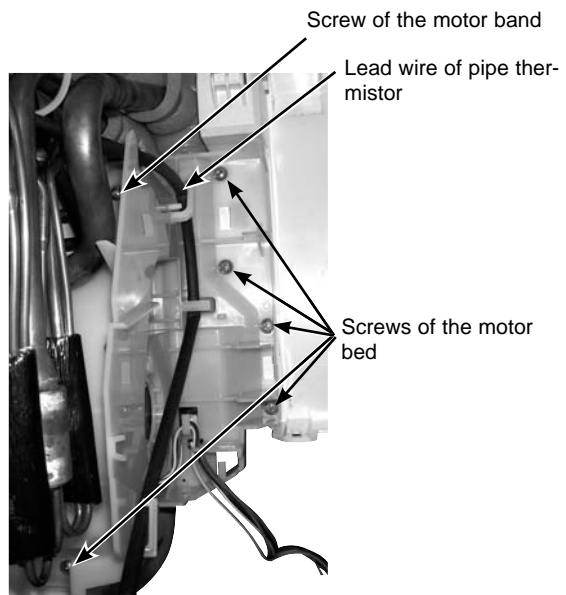
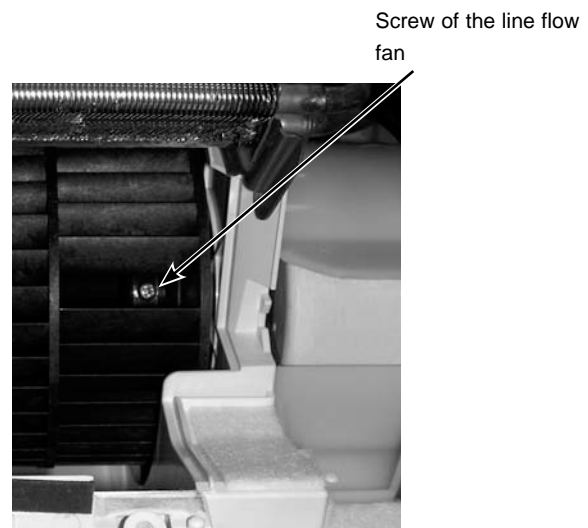

Photo 8



7. REMOVING THE LIQUID PIPE THERMISTOR AND GAS PIPE THERMISTOR

- (1) Remove the panel and the corner box. (Refer to 1)
- (2) Remove the electrical box covers. (Refer to 2.)
- (3) Remove the water cut. (See Photo 2)
- (4) Remove the liquid pipe thermistor and gas pipe thermistors.
- (5) Disconnect the connector (CN44) (CN2G) on the indoor controller board. (TH22 and TH23/CN44, TH24/CN2G)

Photo 10

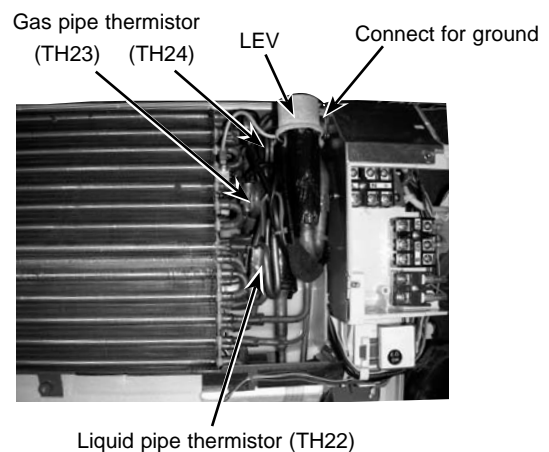



CITY MULTI™

 **MITSUBISHI ELECTRIC CORPORATION**

HEAD OFFICE : TOKYO BLDG., 2-7-3, MARUNOUCHI, CHIYODA-KU TOKYO 100-8310, JAPAN
