

*Changes for the Better*

# AIR CONDITIONERS CITY MULTI

Models **PUHY-P200, P250, P300, P350, P400YGM-A**  
**PUHY-P450, P500, P550, P600, P650YGM-A**  
**PUY-P200, P250, P300, P350YGM-A**

**R410A**

## Service Handbook

**CITY MULTI**

# Contents

1	Read Before Servicing .....	6
	[1] Items to Be Checked .....	6
	[2] Necessary Tools and Materials .....	7
	[3] Piping Materials .....	8
	[4] Storage of Piping Material .....	10
	[5] Piping Machining .....	11
	[6] Brazing.....	12
	[7] Airtightness Test .....	13
	[8] Vacuuming .....	13
	[9] Vacuum Drying.....	14
	[10] Changing Refrigerant.....	15
	[11] Remedies to be taken in case of a refrigerant leak.....	15
	[12] Characteristics of the Conventional and the New Refrigerants ..	16
	[13] Notes on Refrigerating Machine Oil.....	17
2	Restrictions .....	18
	[1] Electrical Work & M-NET control .....	18
	[2] Types of Switch Setting and Address Setting .....	19
	[3] Examples of system connection .....	21
	[4] Restrictions on Refrigerant Piping Length.....	35
3	Components of the Outdoor Unit .....	37
	[1] Appearance of the Components and Refrigerant Circuit.....	37
	[2] Control Box .....	43
	[3] Circuit Board .....	45
4	Remote Controller.....	49
	[1] Functions and Specifications of MA and ME Remote Controllers....	49
	[2] Group Setting and Interlocking Settings that are Made on the ME Remote Controller .....	50
	[3] Interlocking Setting that is Made on the MA Remote Controller .....	53
	[4] Switching to the built-in Thermo on the remote controller.....	54
5	Electrical Wiring Diagram .....	55
	[1] PUHY-P200, P250, P300, P350, P400YGM-A / PUY-P200, P250, P300, P350YGM-A ..	55
	[2] PUHY-P450, P500, P550, P600, P650YGM-A .....	56
	[3] Power Dispatching Extension Unit for the Transmission Lines .....	57
6	Refrigerant Circuit.....	58
	[1] Refrigerant Circuit Diagram .....	58
	[2] Functions of Principal Parts.....	62
7	Control.....	64
	[1] Dip Switch Functions and Their Factory Settings .....	64
	[2] Controlling the Outdoor Unit .....	69
	[3] Operation Flow Chart .....	76
8	Test Run .....	81
	[1] Check Items before Test Run.....	81
	[2] Test Run Method .....	81
	[3] Operating Characteristics and Refrigerant Amount.....	82
	[4] Adjustment and Judgment of Refrigerant Amount .....	82
	[5] Refrigerant Volume Adjustment Mode Operation .....	84
	[6] Symptoms that do not Signify Problems .....	86
	[7] Standard Operation Data (Reference Data) .....	87
9	Troubleshooting .....	95
	[1] Check Code List .....	95
	[2] Responding to Error Display on the Remote Controller .....	98
	[3] Investigation of Transmission Wave Shape/Noise .....	131
	[4] Troubleshooting of Principal Parts .....	134
	[5] Refrigerant Leak .....	151
	[6] Compressor Replacement Instructions (only P450-P650 types)....	153
	[7] Collecting the Cooling Liquid from the Accumulator (Only P450-P650 types) ..	154
10	LED display .....	155
	[1] LED Monitor Display .....	155

# Safety Precautions

- ▶ Before installing the unit, be sure to carefully read all of the following safety precautions.
- ▶ These precautions provide important information regarding safety. Be sure to follow them to ensure safety.

## Symbols used in the text

 **Warning:**

Failure to follow all instructions may result in serious personal injury or death.

 **Caution:**

Failure to follow all instructions may result in personal injury or damage to the unit.

## Symbols used in the illustrations

 : Indicates an action that must be avoided.

 : Indicates that important instructions must be followed.

 : Indicates a part which must be grounded.

 : Beware of electric shock (This symbol is displayed on the main unit label.) <Color : Yellow>

- ▶ After reading this handbook, hand it over to those who will be using the unit.
- ▶ The user of the unit should keep this manual at hand and make it available to those who will be performing repairs or relocating the unit.  
Also, make it available to the new user when the user changes hands.

 **Warning : Carefully read the labels affixed to the main unit.**

### Have the unit professionally installed.

- Improper installation by an unqualified person may result in water leak, electric shock, or fire.

**Place the unit on a stable, level surface that withstands the weight of the unit to prevent the unit from tipping over or falling causing injury as a result.**

**Only use specified cables for wiring. Securely connect each cable, and make sure that the cables are not straining the terminals.**

- Cables not connected securely and properly may generate heat and cause fire.

**Take necessary safety measures against typhoons and earthquakes to prevent the unit from falling over.**

**Do not make any changes or modifications to the unit. In case of problems, consult the dealer.**

- If repairs are not made properly, the unit may leak water and present a risk of electric shock, or it may produce smoke or cause fire.

**Be sure to carefully follow each step in this handbook when installing the unit.**

- Improper installation may result in water leak, electric shock, smoke or fire.

**Have all electrical work performed by a licensed electrician according to the local regulations and the instructions given in this manual. Secure a circuit designated exclusively to the unit.**

- Improper installation or a lack of circuit capacity may cause the unit to malfunction or present a risk of electric shock, smoke, and fire.

**Securely attach the terminal cover (panel) on the unit.**

- If installed improperly, dust and/or water may enter the unit and present a risk of electric shock, smoke, or fire.

**Only use Refrigerant R410A as indicated on the unit when installing or relocating the unit.**

- The use of any other refrigerant or an introduction of air into the unit circuit may cause the unit to run an abnormal cycle and cause the unit to burst.

 **Warning : Carefully read the labels affixed to the main unit.**

**Do not touch the fins on the heat exchanger with bare hands: they are sharp and dangerous.**

**In the event of a refrigerant gas leak, provide adequate ventilation to the room.**

- If leaked refrigerant gas is exposed to a heat source, noxious gases may form.

**With All-Fresh type air conditioners, outdoor air may be directly blown into the room upon thermo off. Take this into consideration when installing the unit.**

- Direct exposure to outdoor air may present a health hazard, and it may also cause food items to deteriorate.

**Do not try to defeat the safety features of the devices, and do not change the settings.**

- Defeating the safety features on the unit such as the pressure switch and temperature switch or using parts other than those specified by Mitsubishi Electric may result in fire or explosion.

**When installing the unit in a small room, safeguard against hypoxia that results from leaked refrigerant reaching the threshold level.**

- Consult the dealer for necessary measures to take.

**When relocating the air conditioner, consult the dealer or a specialist.**

- Improper installation may result in water leak, electric shock, or fire.

**After completing the service work, check for a refrigerant gas leak.**

- If leaked gas refrigerant is exposed to a heat source such as fan heater, stove, and electric grill, noxious gases may form.

**Only use specified parts.**

- Have the unit professionally installed. Improper installation may cause water leak, electric shock, smoke, or fire.

## Precautions for Handling Units for Use with R410A

 **Caution**

**Do not use the existing refrigerant piping**

- The old refrigerant and refrigerator oil in the existing piping contain a large amount of chlorine, which will cause the refrigerator oil in the new unit to deteriorate.
- R410A is a high-pressure refrigerant, and the use of the existing piping may result in bursting.

**Use refrigerant pipes made of C1220 phosphorus deoxidized copper categorized under H3000 (Copper and Copper Alloy Seamless Pipes and Tubes), a standard set by JIS. Keep the inner and outer surfaces of the pipes clean and free of contaminants such as sulfur, oxides, dust/dirt, shaving particles, oils, and moisture.**

- Contaminants inside the refrigerant piping will cause the refrigerant oil to deteriorate.

**Use a vacuum pump with a reverse-flow-check valve.**

- If other types of valves are used, the vacuum pump oil will flow back into the refrigerant cycle and cause the refrigerator oil to deteriorate.

**Do not use the following tools that have been used with the conventional refrigerants. Prepare tools that are for exclusive use with R410A. (Gauge manifold, charging hose, gas leak detector, reverse-flow check valve, refrigerant charge base, vacuum gauge, and refrigerant recovery equipment.)**

- If refrigerant and /or refrigerant oil left on these tools are mixed in with R410A, or if water is mixed with R410A, it will cause the refrigerant to deteriorate.
- Since R410A does not contain chlorine, gas-leak detectors for conventional refrigerators will not work.

 **Caution**

**Store the piping to be used during installation indoors, and keep both ends of the piping sealed until immediately before brazing. (Keep elbows and other joints wrapped in plastic.)**

- If dust, dirt, or water enters the refrigerant cycle, it may cause the oil in the unit to deteriorate or may cause the compressor to malfunction.

**Use a small amount of ester oil, ether oil, or alkylbenzene to coat flares and flange connections.**

- A large amount of mineral oil will cause the refrigerating machine oil to deteriorate.

**Use liquid refrigerant to charge the system.**

- Charging the unit with gas refrigerant will cause the refrigerant in the cylinder to change its composition and will lead to a drop in performance.

**Do not use a charging cylinder.**

- The use of charging cylinder will change the composition of the refrigerant and lead to power loss.

**Exercise special care when handling the tools.**

- An introduction of foreign objects such as dust, dirt, or water into the refrigerant cycle will cause the refrigerating machine oil to deteriorate.

**Only use R410A refrigerant.**

- The use of refrigerants containing chlorine (i.e. R22) will cause the refrigerant to deteriorate.

## Before Installing the Unit

 **Warning**

**Do not install the unit in a place where there is a possibility of flammable gas leak.**

- Leaked gas accumulated around the unit may start a fire.

**Do not use the unit to preserve food, animals, plants, artifacts, or for other special purposes.**

- The unit is not designed to provide adequate conditions to preserve the quality of these items.

**Do not use the unit in an unusual environment.**

- The use of the unit in the presence of a large amount of oil, steam, acid, alkaline solvents, or special types of sprays may lead to a remarkable drop in performance and/or malfunction and presents a risk of electric shock, smoke, or fire.
- The presence of organic solvents, corroded gas (such as ammonia, sulfur compounds, and acid) may cause gas or water leak.

**When installing the unit in a hospital, take necessary measures against noise.**

- High-frequency medical equipment may interfere with the normal operation of the air conditioning unit or the air conditioning unit may interfere with the normal operation of the medical equipment.

**Do not place the unit on or over things that may not get wet.**

- When humidity level exceeds 80% or when the drainage system is clogged, indoor units may drip water.
- Installation of a centralized drainage system for the outdoor unit may also need to be considered to prevent water drips from the outdoor units.

## Before Installing (Relocating) the Unit or Performing Electric Work

 **Caution**

### Ground the unit.

- Do not connect the grounding on the unit to gas pipes, water pipes, lightning rods, or the grounding terminals of telephones. Improper grounding presents a risk of electric shock, smoke, fire, or the noise caused by improper grounding may cause the unit to malfunction.

### Use breakers and fuses (electrical current breaker, remote switch <switch + Type-B fuse>, molded case circuit breaker) with a proper current capacity.

- The use of large-capacity fuses, steel wire, or copper wire may damage the unit or cause smoke or fire.

### Make sure the wires are not subject to tension.

- If the wires are too taut, they may break or generate heat and/or smoke and cause fire.

### Do not spray water on the air conditioners or immerse the air conditioners in water.

- Water on the unit presents a risk of electric shock.

### Install a breaker for current leakage at the power source to avoid the risk of electric shock.

- Without a breaker for current leakage, there is a risk of electric shock, smoke, or fire.

### Periodically check the platform on which the unit is placed for damage to prevent the unit from falling.

- If the unit is left on a damaged platform, it may topple over, causing injury.

### Use wires that are specified in the installation manual.

- The use of other types of wires presents a risk of electrical current leak, electric shock, smoke, or fire.

### When installing draining pipes, follow the instructions in the manual, and make sure that they properly drain water so as to avoid dew condensation.

- If not installed properly, they may cause water leaks and damage the furnishings.

### Exercise caution when transporting products.

- Do not try to move equipments over 20kg (approx. 44 lbs.) alone.
- Do not use the PP bands used on some packages for transportation.
- Wear protective gloves to avoid injury caused by touching the fins on the heat exchanger with bare hands.
- When using a suspension bolt to transport the heat-source unit, use a four-point suspension. A three-point suspension does not provide adequate stability and presents a risk of accidents.

### Properly dispose of the packing materials.

- Things such as nails and wood pieces may be included in the package. Dispose of them properly to prevent injury.
- Plastic bags present a choking hazard to children. Tear up the plastic bags before disposing of them to prevent accidents.

## Before the Test Run

 **Caution**

**Turn on the unit at least 12 hours before the test run.**

- Keep the unit on throughout the season. Turning the unit off during the season may cause problems.

**Do not operate switches with wet hands to avoid electric shock.**

**Do not touch the refrigerant pipes with bare hands during and immediately after operation.**

- Depending on the state of the refrigerant in the system, certain parts of the unit such as the pipes and compressor may become very cold or hot and may subject the person to frost bites or burning.

**Do not operate the unit without panels and safety guards in their proper places.**

- They are there to keep the users from injury from accidentally touching rotating, high-temperature, or high-voltage parts.

**Do not turn off the power immediately after stopping the unit.**

- Allow for at least five minutes before turning off the unit; otherwise, the unit may leak water or experience other problems.

**Do not operate the unit without air filters.**

- Dust particles in the air may clog the system and cause malfunction.

## **1 Read Before Servicing**

### **[1] Items to Be Checked**

**1. Verify the type of refrigerant used by the unit to be serviced.**

Refrigerant Type : R410A

**2. Check the symptom exhibited by the unit to be serviced.**

Look in this service handbook for symptoms relating to the refrigerant cycle.

**3. Be sure to carefully read the *Safety Precautions* at the beginning of this document.**

**4. Prepare necessary tools: Prepare tools exclusive for use with each refrigerant type.**

Refer to P7 for more information.

**5. If the refrigerant circuit is opened (to repair a gas leak etc.), the dryer needs to be replaced.**

Only use the dryer designed specifically for Citi Multi YGM-A. The use of other dryers may result in malfunctions.

※ Replace the dryer after completing all the repairs on the refrigerant circuit.

(If left exposed to air, the dryer will absorb moisture. Replace the dryer as quickly as possible after removing the old one.)

※ When all of the following conditions are met, the replacement of drier is not necessary.

- (1) Do not leave the refrigerant circuit longer than 2 hours.
- (2) Cover the opening end with a cap or tape to keep moisture from entering.
- (3) Also cover the opening end of the new part with a cap or tape
- (4) Do not perform the task in the rain.
- (5) Evacuate the refrigerant circuit as specified.

**6. Verification of the connecting pipes: Verify the type of refrigerant used for the unit to be moved or replaced.**

- Use pipes made of phosphorus deoxidized copper. Keep the inner and outer surfaces of the pipes clean and free of contaminants such as sulfur, oxides, dust/dirt, shaving particles, oils, and moisture.
- Contaminants inside the refrigerant piping will cause the refrigerant oil to deteriorate.

**7. If there is a gas leak or if the remaining refrigerant is exposed to an open flame, a noxious gas hydrofluoric acid may form. Keep workplace well ventilated.**



### **CAUTION**

- 1. Install new pipes immediately after removing old ones to keep moisture out of the refrigerant circuit.**
- 2. Chloride in some types of refrigerants such as R22 will cause the refrigerating machine oil to deteriorate.**



## [2] Necessary Tools and Materials

Prepare the following tools and materials necessary for installing and servicing the unit.

### [Necessary tools for use with R410A (Adaptability of tools that are for use with R22 and R407C)]

#### 1. To be used exclusively with R410A (not to be used if used with R22 or R407C)

Tools/Materials	Use	Notes
Gauge Manifold	Evacuating, refrigerant charging	5.09MPa on the High-pressure side.
Charging Hose	Evacuating, refrigerant charging	Hose diameter larger than the conventional ones.
Refrigerant Recovery Equipment	Refrigerant recovery	
Refrigerant Cylinder	Refrigerant charging	Write down the refrigerant type. Pink in color at the top of the cylinder.
Refrigerant Cylinder Charging Port	Refrigerant charging	Hose diameter larger than the conventional ones.
Flare Nut	Connecting the unit to piping	Use Type-2 Flare nuts. (That are in compliance with JIS B 8607).

#### 2. Tools and materials that may be used with R410A with some restrictions

Tools/Materials	Use	Notes
Gas leak detector	Detection of gas leaks	The ones for HFC type refrigerant may be used.
Vacuum Pump	Vacuum drying	May be used if a reverse flow check adaptor is attached.
Flare Tool	Flare machining of piping	Changes have been made in the flare machining dimension. Refer to the next page.
Refrigerant Recovery Equipment	Recovery of refrigerant	May be used if designed for use with R410A.

#### 3. Tools and materials that are used with R22 or R407C that can also be used with R410A

Tools/Materials	Use	Notes
Vacuum Pump with a Check valve	Vacuum drying	
Bender	Bending pipes	
Torque Wrench	Tightening flare nuts	Only $\phi$ 12.70 (1/2") and $\phi$ 15.88 (5/8") have a larger flare machining dimension.
Pipe Cutter	Cutting pipes	
Welder and Nitrogen Cylinder	Welding pipes	
Refrigerant Charging Meter	Refrigerant charging	
Vacuum Gauze	Checking vacuum degree	

#### 4. Tools and materials that must not be used with R410A

Tools/Materials	Use	Notes
Charging Cylinder	Refrigerant Charging	Must not be used with R410A-type units.

**Tools for R410A must be handled with special care; keep moisture and dust from entering the cycle.**

### [3] Piping Materials

**Do not use the existing piping!**

**New Piping**      **Existing Piping**

**<Types of copper pipe>**

Type-O pipes	Soft copper pipes (annealed copper pipes) They can be bent easily with hands.
Type-1/2H pipes	Hard copper pipes (straight pipes) Stronger than type-O pipes of the same radial thickness.

- The distinction between type-O and type-1/2H pipes is made based on the strength of the pipes themselves.
- Type-O pipes are soft and can easily be bent with hands.
- Type-1/2H pipes are considerably stronger than type-O pipes of the same radial thickness.

**<Types of Copper Pipes (Reference)>**

Maximum Operation Pressure	Applicable Refrigerants
3.45 MPa	R22, R407C etc.
4.30 MPa	R410A

\* Use pipes that meet the local standards.

**<Piping Materials/Radial Thickness>**

Use pipes made of phosphorus deoxidized copper.  
 Since the operation pressure of the units that use R410A is higher than that of the units for use with R22, use pipes with at least the radial thickness specified in the chart below.  
 (Pipes with a radial thickness of 0.7 mm or less may not be used.)

Size(mm)	Size(inch)	Radial Thickness(mm)	Type
φ 6.35	1/4"	0.8t	Type-O pipes
φ 9.52	3/8"	0.8t	
φ 12.7	1/2"	0.8t	
φ 15.88	5/8"	1.0t	
φ 19.05	3/4"	1.0t	Type-1/2H or H pipes
φ 22.2	7/8"	1.0t	
φ 25.4	1"	1.0t	
φ 28.58	1 1/8"	1.0t	
φ 31.75	1 1/4"	1.1t	

- \* Although it was possible to use type-O for pipes with a size of up to φ19.05 (3/4") with conventional refrigerants, use type-1/2H pipes for units that use R410A. (Type-O pipes may be used if the pipe size is φ19.05 and the radial thickness is 1.2t.)
- \* The table shows the standards in Japan. Using this table as a reference, choose pipes that meet the local standards.

**<Indication of the radial thickness and refrigerant type on the piping materials>**

“Radial thickness” and “Refrigerant Types” are indicated on the insulation material on the piping materials for the new refrigerant.

Indication of the radial thickness (mm)

Radial thickness	Symbols
0.8	08
1.0	10

Indication of the refrigerant type

Refrigerant type	Symbol
Type1 R22, R407C	①
Type2 R410A	②

<Example of the symbols indicated on the insulation material>

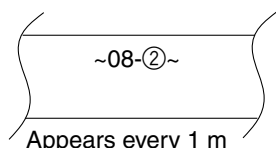

The type of piping materials can also be found on the package.

<Example of a label found on the package>

②	: common to type 1 and type 2
Refrigerant Type	: R22,R407C,R410A
Bore diameter and radial thickness of the copper piping	: 9.52×0.8, 15.88×1.0

**<Flare Machining (type-O and OL only)>**

The flare machining dimensions for units that use R410A is larger than those for units that use R22 in order to increase air tightness.

Flare Machining Dimension(mm)

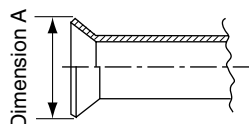

External dimension of pipes	Size	Dimension A	
		R410A	R22
φ 6.35	1/4"	9.1	9.0
φ 9.52	3/8"	13.2	13.0
φ 12.7	1/2"	16.6	16.2
φ 15.88	5/8"	19.7	19.4
φ 19.05	3/4"	24.0	23.3

If a clutch type flare tool is used to machine flares on units that use R410A, make the protruding part of the pipe between 1.0 and 1.5mm. Copper pipe gauge for adjusting the length of pipe protrusion is useful.

**<Flare Nut>**

Type-2 flare nuts instead of type-1 s are used to increase the strength. The size of some of the flare nuts have also been changed.

Flare nut dimension(mm)

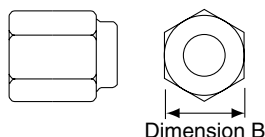

External dimension of pipes	Size	Dimension B	
		R410A(Type2)	R22(Type1)
φ 6.35	1/4"	17.0	17.0
φ 9.52	3/8"	22.0	22.0
φ 12.7	1/2"	26.0	24.0
φ 15.88	5/8"	29.0	27.0
φ 19.05	3/4"	36.0	36.0

※ The table shows the standards in Japan. Using this table as a reference, choose pipes that meet the local standards.

## [4] Storage of Piping Material

### 1. Storage location



Store the pipes to be used indoors. (Warehouse at site or owner's warehouse)  
Storing them outdoors may cause dirt, waste, or water to infiltrate.

### 2. Pipe sealing before storage

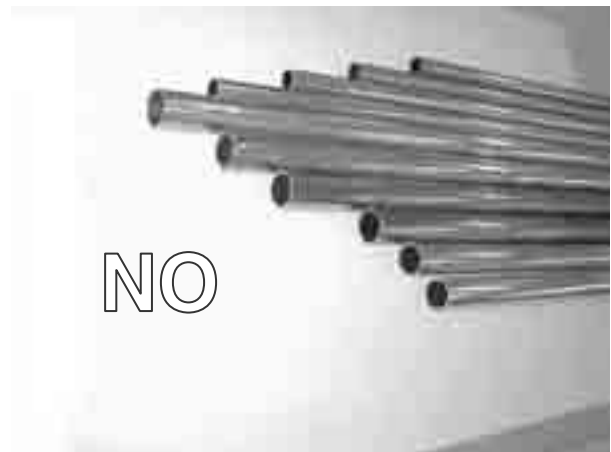
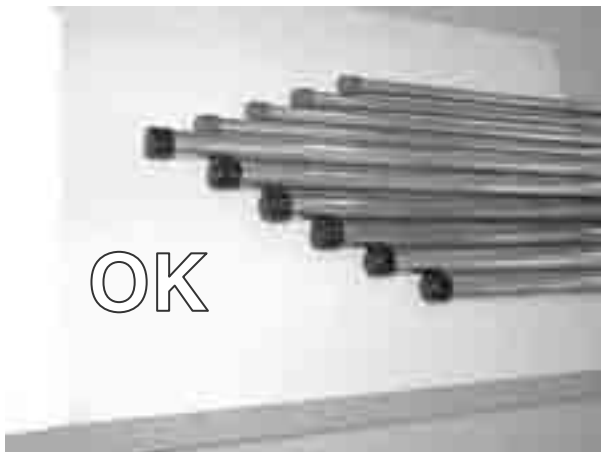

Both ends of the pipes should be sealed until immediately before brazing.  
Wrap elbows and T's in plastic bags for storage.

\* The new refrigerator oil is 10 times more hygroscopic than the conventional refrigerator oil (such as Suniso). Water infiltration in the refrigerant circuit may deteriorate the oil or cause a compressor failure. Piping materials must be stored with more care than with the conventional refrigerant pipes.

## [5] Piping Machining

Use ester oil, ether oil or alkylbenzene (small amount) as the refrigerator oil to coat flares and flange connections.

### **Reason :**

1. The refrigerator oil used for the equipment is highly hygroscopic and may introduce water inside.

### **Notes :**

- Introducing a great quantity of mineral oil into the refrigerant circuit may also cause a compressor failure.
- Do not use oils other than ester oil, ether oil or alkylbenzene.

## [6] Brazing

No changes from the conventional method, but special care is required so that foreign matter (ie. oxide scale, water, dirt, etc.) does not enter the refrigerant circuit.

Example : Inner state of brazed section

When non-oxide brazing was not used

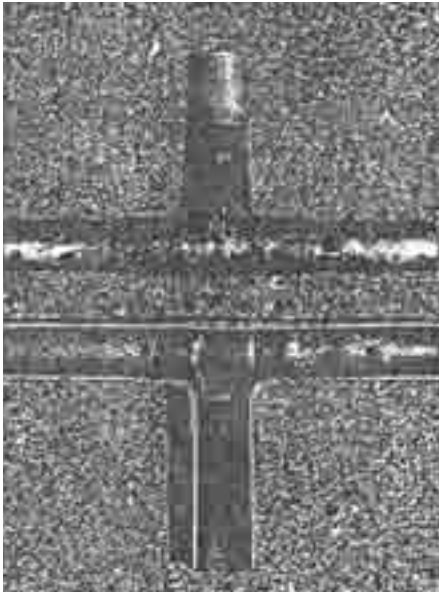

When non-oxide brazing was used



### Items to be strictly observed :

1. Do not conduct refrigerant piping work outdoors on a rainy day.
2. Apply non-oxide brazing.
3. Use a brazing material (BCuP-3) which requires no flux when brazing between copper pipes or between a copper pipe and copper coupling.
4. If installed refrigerant pipes are not immediately connected to the equipment, then braze and seal both ends of them.

### Reasons :

1. The new refrigerant oil is 10 times more hygroscopic than the conventional oil. The probability of a machine failure if water infiltrates is higher than with conventional refrigerant oil.
2. A flux generally contains chlorine. A residual flux in the refrigerant circuit may generate sludge.

### Note :

- Commercially available antioxidants may have adverse effects on the equipment due to its residue, etc. When applying non-oxide brazing, use nitrogen.

## [7] Airtightness Test

No changes from the conventional method. Note that a refrigerant leakage detector for R22 or R407C cannot detect R410A leakage.

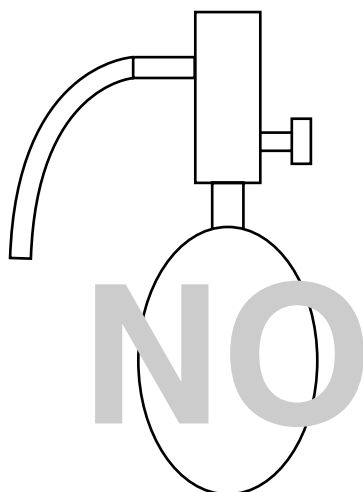

Halide torch

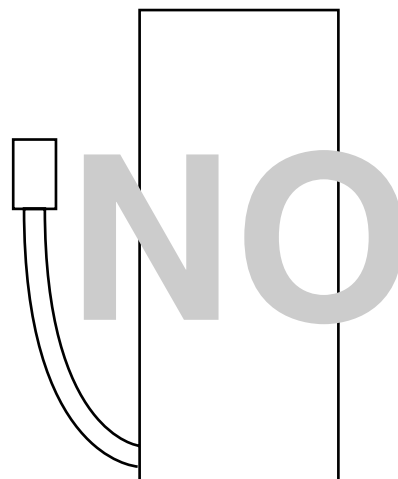

R22 or R407C leakage detector

### Items to be strictly observed :

1. Pressurize the equipment with nitrogen up to the design pressure and then judge the equipment's airtightness, taking temperature variations into account.
2. When investigating leakage locations using a refrigerant, be sure to use R410A.
3. Ensure that R410A is in a liquid state when charging.

### Reasons :

1. Use of oxygen as the pressurized gas may cause an explosion.
2. Charging with R410A gas will lead the composition of the remaining refrigerant in the cylinder to change and this refrigerant can then not be used.

### Note :

- A leakage detector for R410A is sold commercially and it should be purchased.

## [8] Vacuuming

### 1. Vacuum pump with check valve

A vacuum pump with a check valve is required to prevent the vacuum pump oil from flowing back into the refrigerant circuit when the vacuum pump power is turned off (power failure).

It is also possible to attach a check valve to the actual vacuum pump afterwards.

### 2. Standard degree of vacuum for the vacuum pump

Use a pump which reaches 650Pa or below after 5 minutes of operation.

In addition, be sure to use a vacuum pump that has been properly maintained and oiled using the specified oil. If the vacuum pump is not properly maintained, the degree of vacuum may be too low.

### 3. Required accuracy of the vacuum gauge

Use a vacuum gauge that can measure up to 650Pa. Do not use a general gauge manifold since it cannot measure a vacuum of 650Pa.

### 4. Evacuating time

- Evacuate the equipment for 1 hour after 650Pa has been reached.
- After evacuating, leave the equipment for 1 hour and make sure the that vacuum is not lost.

### 5. Operating procedure when the vacuum pump is stopped

In order to prevent a backflow of the vacuum pump oil, open the relief valve on the vacuum pump side or loosen the charge hose to drawn in air before stopping operation.

The same operating procedure should be used when using a vacuum pump with a check valve.

## [9] Vacuum Drying



Photo 1 15010H



Photo 2 14010

**Recommended vacuum gauge :** ROBINAIR 14010 Thermistor Vacuum Gauge

### 1. Vacuum pump with reverse-flow check valve (Photo 1)

To prevent vacuum pump oil from flowing back into the refrigerant circuit upon turning off the vacuum pump's power source, use a vacuum pump equipped with a reverse flow check valve.

A check valve may also be added to the vacuum pump currently in use.

### 2. Standard of vacuum degree (Photos 1 and 2)

Use a vacuum pump that shows a vacuum degree of 65Pa or less after 5 minutes of operation. Use a pump well-maintained with an appropriate lubricant.

### 3. Required precision of vacuum gauge

Use a vacuum gauge that registers a vacuum degree of 650Pa and measures at intervals of 130Pa. (A recommended vacuum gauge is shown in Photo 2.)

Do not use a vacuum gauge that does not register a vacuum degree of 650Pa.

### 4. Evacuation time

- After the vacuum gauge has registered the vacuum degree of 650Pa, evacuate for 1 hour. (A thorough vacuum drying removes moisture in the pipes.)
- Verify that the vacuum degree has not risen by more than 130Pa 1 hour after evacuation. A rise by less than 130Pa is acceptable.
- If it has exceeded by more than 130Pa, conduct vacuuming following the instructions in the "6. Special vacuum drying" section.

### 5. Procedures for stopping vacuum pump

To prevent the reverse flow of vacuum pump oil, open the relief valve on the vacuum pump side, or draw in air by loosening the charge hose, and then stop the operation.

The same procedures should be followed when stopping a vacuum pump with a reverse-flow check valve.

### 6. Special vacuum drying

- When 650Pa or lower degree of vacuum cannot be attained after 3 hours of evacuation, it is likely that water has penetrated the system or that there is a leak. When water infiltration is suspected, vacuum with nitrogen gas. After breaking the vacuum, pressurize the system with nitrogen gas to a degree of 0.05MPa, and conduct an evacuation again. Repeat it until 650Pa or lower degree of vacuum is attained or the vacuum pressure rise will be lost.
- Only use nitrogen gas for vacuum breaking. (Use of oxygen may cause an explosion.)



## [10] Changing Refrigerant

R410A must be in a liquid state when charging.

For a cylinder with a syphon attached

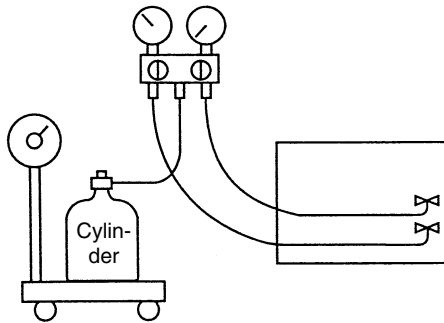

For a cylinder without a syphon attached

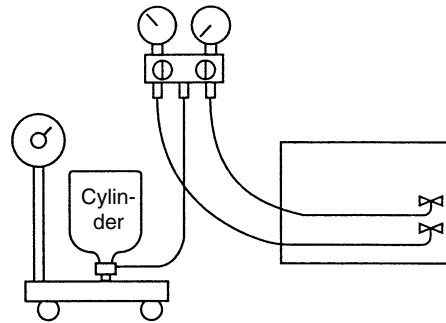

Cylinder color identification

R407C-Gray  
R410A-Pink

Charged with liquid refrigerant

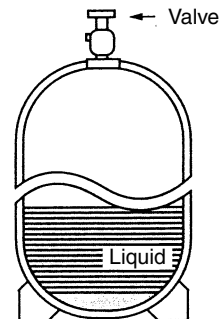
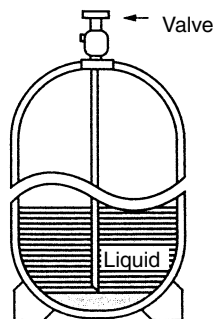

### Reasons :

1. R410A is a pseudo-azeotropic refrigerant (boiling point R32 =  $-52^{\circ}\text{C}$ , R125 =  $-49^{\circ}\text{C}$ ) and can roughly be handled in the same way as R22; however, be sure to fill the refrigerant from the liquid side, for doing so from the gas side will somewhat change the composition of the refrigerant in the cylinder.

### Note :

- In the case of a cylinder with a syphon, liquid R410A is charged without turning the cylinder up side down. Check the type of cylinder before charging.

## [11] Remedies to be taken in case of a refrigerant leak

When refrigerant leaks, additional refrigerant may be charged. (Add the refrigerant from the liquid side.)

\*Refer to [9]-[5].

## [12] Characteristics of the Conventional and the New Refrigerants

### 1. Chemical property

As with R22, the new refrigerant (R410A) is low in toxicity and a chemically stable non-flammable refrigerant. However, because the specific gravity of steam is greater than that of air, leaked refrigerant in a closed room will accumulate at the bottom of the room and may cause hypoxia. Also, leaked refrigerant exposed directly to an open flame will generate noxious gasses. Use the unit in a well-ventilated room.

	New Refrigerant (HFC system)		Conventional Refrigerant (HCFC system)
	R410A	R407C	R22
	R32/R125	R32/R125/R134a	R22
Composition (wt%)	(50/50)	(23/25/52)	(100)
Type of refrigerant	Simulated azeotropic refrigerant	Non-azeotropic refrigerant	Single refrigerant
Chloride	Not contained	Not contained	Contained
Safety Class	A1/A1	A1/A1	A1
Molecular Weight	72.6	86.2	86.5
Boiling Point	-51.4	-43.6	-40.8
Steam Pressure (25°C,MPa)(gauge)	1.557	0.9177	0.94
Saturated Steam Density (25°C,kg/m <sup>3</sup> )	64.0	42.5	44.4
Flammability	Non-flammable	Non-flammable	Non-flammable
Ozone Depletion Coefficient (ODP)*:1	0	0	0.055
Global Warming Coefficient (GWP)*:2	1730	1530	1700
Refrigerant charging method	Liquid charging	Liquid charging	Gas charging
Addition of refrigerant in case of a leak	Possible	Possible	Possible

\*:1: When CFC11 is used as a reference    \*:2: When CO<sub>2</sub> is used as a reference

### 2. Refrigerant Composition

Because R410A is a simulated azeotropic refrigerant, it can be handled in almost the same manner as a single refrigerant such as R22. However, if the refrigerant is removed in the vapor phase, the composition of the refrigerant in the cylinder will somewhat change.

Remove the refrigerant in the liquid phase. Additional refrigerant may be added in case of a refrigerant leak.

### 3. Pressure Characteristics

The pressure in the units that use R410A is 1.6 times as great as that in the units that use R22.

Temperature (°C)	Pressure (gauge)	R410A	R407C	R22
		MPa	MPa	MPa
-20		0.30	0.18	0.14
0		0.70	0.47	0.40
20		1.34	0.94	0.81
40		2.31	1.44	1.44
60		3.73	2.44	2.33
65		4.17	2.75	2.60

## [13] Notes on Refrigerating Machine Oil

### 1. Refrigerating Machine Oil in the HFC Refrigerant System

HFC type refrigerants use a refrigerating machine oil different from that used in the R22 refrigerant system. Please note that the ester oil sealed in the unit is not the same as commercially available ester oil.

Refrigerant	Refrigerating machine oil
R22	Mineral oil
R407C	Ester oil
R410A	Ester oil

### 2. Effects of the \*Contaminants in the System

Refrigerating machine oil used in the HFC system must be handled more carefully than conventional mineral oils. The table below shows the effects of air, moisture, and contaminants in the refrigerating machine oil on the refrigeration cycle.

#### <The Effects of Air, Moisture, and Contaminants in the Refrigerating Machine Oil on the Refrigeration Cycle.>

Cause		Symptom	Effects on the refrigeration cycle
Water infiltration		Expansion valve and capillary freeze	Clogged expansion valve and capillary Poor cooling performance
		Hydrolysis	Compressor overheat Poor motor insulation Motor burning Coppering of the orbiting part Locking Burning in the orbiting part
Air infiltration		Oxidization	
Infiltration of contaminants	Dust, dirt	Adhesion to expansion valve and capillary	Expansion valve/capillary Poor cooling performance Drier clogging Compressor overheat
		Infiltration of contaminants into the compressor	Burning in the orbiting part
	Mineral oil etc.	Sludge formation and adhesion	Expansion valve and capillary clogging Poor cooling performance Compressor overheat
		Oil degradation	Burning in the orbiting part

\* "Contaminants" is defined as moisture, air, process oil, dust/dirt, the wrong types of refrigerant and refrigerating machine oil.

## 2 Restrictions

### [1] Electrical Work & M-NET control

#### 1. Attention

- ① Follow ordinance of your governmental organization for technical standard related to electrical equipment, wiring regulations, and guidance of each electric power company.
- ② Wiring for control (hereinafter referred to as transmission line) shall be (5cm or more) apart from power source wiring so that it is not influenced by electric noise from power source wiring. (Do not insert transmission line and power source wire in the same conduit.)
- ③ Be sure to provide designated grounding work to outdoor unit.
- ④ Give some allowance to wiring for electrical part box of indoor and outdoor units, because the box is sometimes removed at the time of service work.
- ⑤ Never connect 380~415V(220~240V) power source to terminal block of transmission line. If connected, electrical parts will be burnt out
- ⑥ Use 2-core shield cable for transmission line. If transmission lines of different systems are wired with the same multiple-core cable, the resultant poor transmitting and receiving will cause erroneous operations.

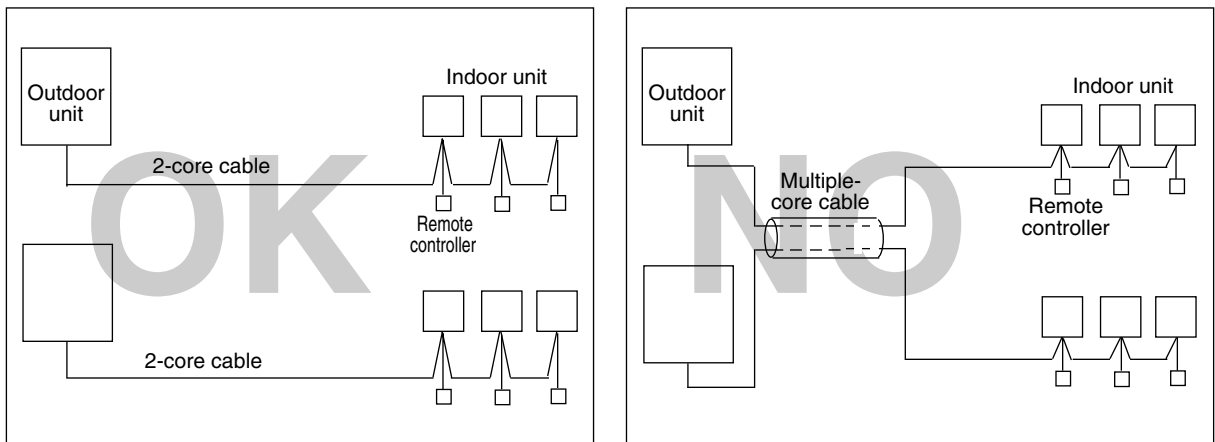

#### 2. Types of control cable

	Transmission cables	M-NET Remote controller cables	MA Remote controller cables
Type of cable	Shielding wire (2-core) CVVS or CPEVS	Sheathed 2-core cable (unshielded) CVV	
Cable diameter	More than 1.25mm <sup>2</sup>	0.3 ~ 1.25mm <sup>2</sup> (0.75 ~ 1.25mm <sup>2</sup> ) *1	0.3 ~ 1.25mm <sup>2</sup> (0.75 ~ 1.25mm <sup>2</sup> ) *1
Remarks	—	When 10m is exceeded, use cables with the same specification as transmission cables.	Max length : 200m

\*1 Connected with simple remote controller.

CVVS : PVC insulated PVC jacketed shielded control cable

CPEVS : PE insulated PVC jacketed shielded communication cable

CVV : PV insulated PVC sheathed control cable

## [2] Types of Switch Setting and Address Setting

### 1. Switch setting

#### Type and method of switch setting

Switch setting vary depending on the system configuration. Make sure to read “[3] Examples of system connection” before conducting electrical work. Turn off the power before setting the switch. Operating the switch while the unit is being powered will not change the setting, and the unit will not properly function.

### 2. Address setting

(1) Address setting varies depending on the system configuration. See “[3] Examples of system connection” section for details.

Unit or controller		Symbol	Address setting range	Setting method	Factory setting
Indoor unit	Main/sub units	IC	0, 01~50 (Note 1)	Assign the smallest address to the indoor unit to become the main unit within the same group, and then use sequential numbers to assign an address to all the indoor units in the group. (Note 5) If applicable, set the sub BC controllers in an R2 system in the following order: (1) Indoor unit to be connected to the main BC controller (2) Indoor unit to be connected to No.1 sub BC controller (3) Indoor unit to be connected to No.2 sub BC controller Set the address so that (1) < (2) < (3)	00
	Lossnay	LC		Assign any unused address after setting all indoor units.	00
M-NET remote controller	Main remote controller	RC	101~150	Set to the lowest address of the indoor main unit within the same group + 100.	101
	Sub remote controller	RC	151~200 (Note 2)	Set to the lowest address of the indoor main unit within the same group + 150.	
MA remote controller		MA	No address setting required. (When operating with 2 remote controllers, the main/sub selector switch must be set.		Main
Outdoor unit		OC	0, 51~100 (Note 1, 3, 4)	Use the address that equals the sum of the smallest indoor unit address in the same refrigerant system and 50.	00
Auxiliary units	Hex. unit	OS	52~100 (Note 3, 4)	Use the address that equals the sum of the address of the outdoor unit in the same refrigerant system and 1.	
	BC controller (Main)	BC			
	BC controller (Sub)	BS		Use the address that equals the sum of the smallest address of the indoor unit out of all the indoor units that are connected to the BC controller and 50. When a sub BC controller is connected, the automatic start up function will not be available.	
System controller	Group remote controller	GR, SC	201~250	Set to the lowest No. of the group to be controlled + “200.”	201
	System remote controller	SR, SC	201~250	Choose any number within the range of addresses shown left.	201
	ON/OFF remote controller	AN, SC	201~250	Set to the lowest No. of the group desired to be controlled + “200.”	201
	Schedule timer (for M-NET)	ST, SC	201~250	Choose any number within the range of addresses shown left.	202
	Centralized controller (Note 5)	TR, SC	0, 201~250	Choose any number within the range of addresses shown left. However when using with the upper SC setting, or wishing to control the k-control units, set to “0.”	000
	LM adapter	SC	201~250	Choose any number within the range of addresses shown left.	247

#### Notes:

- Address setting is not required for a single refrigerant system (with a few exception).
- When setting M-NET remote controller address to “200,” make it “00.”
- When setting the outdoor unit and outdoor auxiliary unit address to “100,” make it “50.”
- When an address in a system overlapped with the outdoor unit or BC controller (Main) address of other refrigerant system, choose an another address within the set range that is not in use (with a few exceptions).
- When controlling the K-control units;
  - A K-transmission converter (Model name: PAC-SC25KA) is required. To set the address for the K-transmission converter, set it to the lowest address of the K-control unit to be controlled + 200.
  - Set the address of the system controller (G-50A) to “0.” The K-control unit can only be controlled by the system controller with the address “0.”
  - To control both K-control unit and M-NET model unit, make the address of the K-control unit larger than that of the indoor unit of M-NET model.  
Group-register on the system controller so that the group No. and the lowest address of the K-controlled indoor units belonging to the group will be identical.

(2) Setting the power supply selecting connector for the outdoor unit (Factory setting: CN41 is connected.)

System Configuration	Connection with the system controller	Power supply unit for the transmission lines	Grouping operation of different refrigerant systems	The setting of the power supply selecting connector
Single refrigerant system	—	—	—	Use CN41 as is (Factory setting)
Multiple refrigerant system	n/a	—	n/a	
	Connected with the indoor units	Unnecessary	applicable	Replace the CN41 with CN40 on only one of the outdoor units. *Connect the S terminal of the TB7 (terminal block on the outdoor unit) on the outdoor unit whose CN41 was replaced with CN40 to the earth terminal of the electric box.
			applicable // n/a	
	Connected with the centralized system	Unnecessary (Note2) (Supplied from the outdoor unit)	applicable // n/a	
Applicable			applicable // n/a	

Notes:

- Will limit the total connectable units in the refrigerant system.
- The need for a power supply unit for the transmission lines depends on the system configuration. Refer to “ DATA BOOK ” for more details.

(3) Setting the centralized control switch on the outdoor unit (factory setting: SW2-1 OFF )

System configuration	Setting of the centralized controller switch (SW 2-1)
Connection system with the system controller n/a	Leave it to OFF. (Factory setting)
Connection system with the system controller applicable (Note 1)	ON

Note:

- When connecting only the LM adapter, leave SW2-1 to OFF.

(4) Various types of control using the connectors on the outdoor unit for input-output signal  
(various types of connections with optional parts)

Category	Usage	Function	Terminal to be used
Input	Cooling operation is disabled (thermo OFF) by the external input to the outdoor units. * Can be used as an on-demand control for each refrigerant system.	Demand (level)	CN3D
	Quiet operation of outdoor units is run with an external input to the outdoor units. (Night mode can be run under the following conditions: Outdoor air temperature below 30°C when running a cooling operation and above 3°C when running a heating operation.)	Night mode or Demand (Level) * Note1	
	Forces the outdoor units to run a fan operation by receiving the snow signal from the snow sensor. The operation mode can be switched between cooling and heating with an external input to the outdoor units.	Snow sensor Signal input (level)	CN3S
	You can switch the operation mode between cooling and heating by input from the outside to the outdoor unit.	Auto-changeover	CN3N
Output	Outdoor units' signal output * Can be used as a device that displays the operation status * Can run an interlocking control operation with external devices	Compressor in operation	CN51
		Abnormal operation status	

Note:

- Refer to section “[7](#) [2] 12. Demand control ” for detailed information on demand control settings.

### [3] Examples of system connection

#### 1. System using MA remote controller

(1) In the case of single refrigerant system (Automatic address set-up)

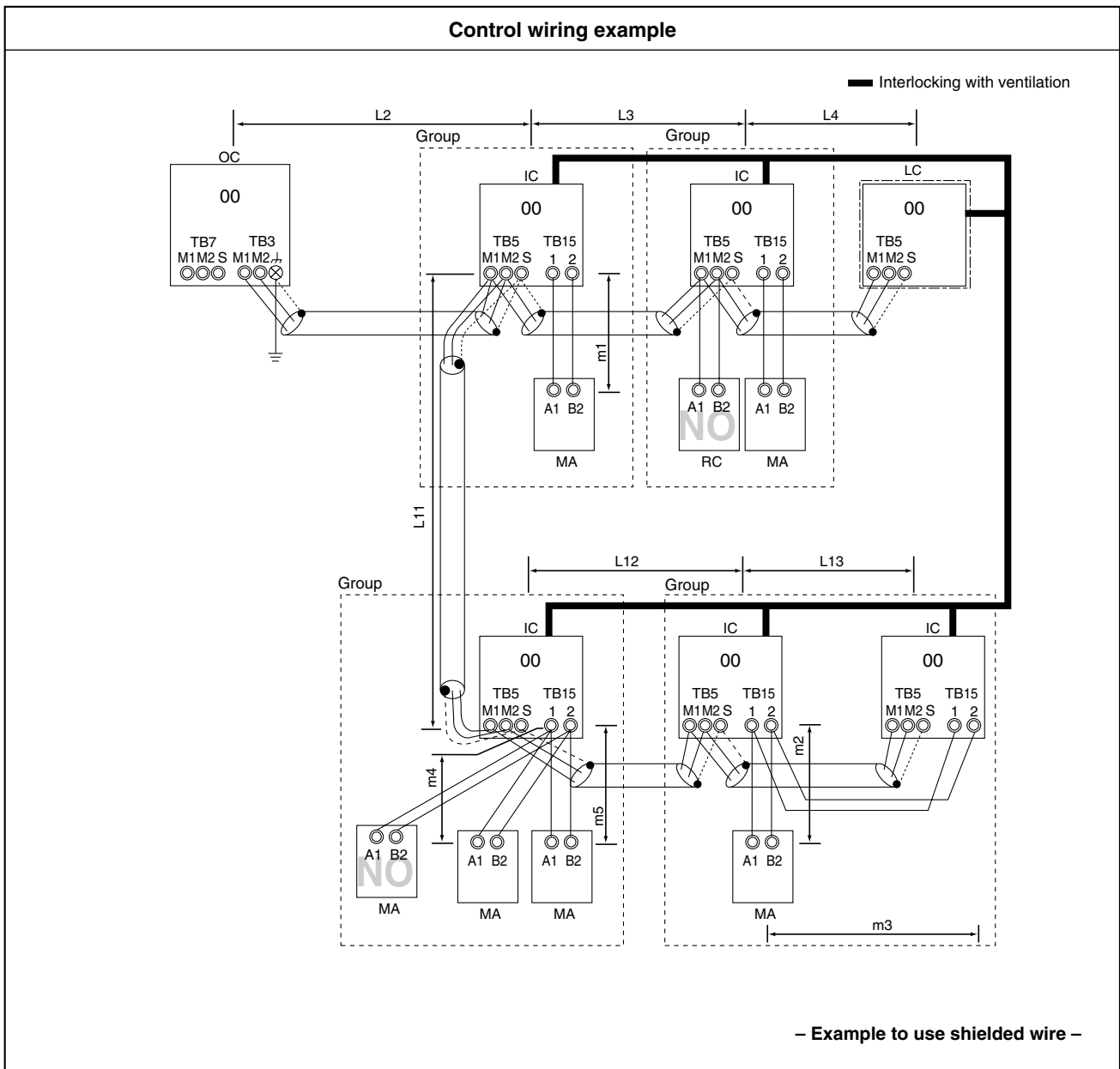

Prohibited items	Allowable length
<ol style="list-style-type: none"> <li>1. M-NET and MA remote controllers can not be connected together to the indoor unit within the same group.</li> <li>2. MA remote controller of 3 units or more can not be connected to the indoor unit within the same group.</li> <li>3. When the total number of indoor units exceeds 26 units Including that above Type 200, a transmission booster is required.</li> <li>4. In the case when start/stop input (CN32, CN51, CN41) is used by indoor group operation, the “Automatic address set-up” can not be employed. Please refer to 1. (2) “Manual address set-up.”</li> <li>5. For the connection of LOSSNAY with more than 2 units in a single refrigerant system, refer to the following “Connection of 2 LOSSNAY units in refrigerant system.”</li> </ol>	<ol style="list-style-type: none"> <li><b>a. Indoor/outdoor transmission line</b>                      Farthest length (1.25mm<sup>2</sup> or more)  <math>L2 + L3 + L4 \leq 200\text{m}</math>  <math>L2 + L11 + L12 + L13 \leq 200\text{m}</math> </li> <li><b>b. Centralized control transmission line</b>                      No connection is required.</li> <li><b>c. MA remote controller wiring</b>                      Total length (0.3 ~ 1.25mm<sup>2</sup>)  <math>m1 \leq 200\text{m}</math>  <math>m2 + m3 \leq 200\text{m}</math>  <math>m4 + m5 \leq 200\text{m}</math> </li> </ol> <p>Note 1. For the connection to the terminal block of compact remote controller, employ wire with a diameter of 0.75 ~ 1.25mm<sup>2</sup></p>

## Wiring method • Address setting method

### a. Indoor/outdoor transmission line

Apply jumper wiring connection between M1, M2 terminals of the indoor/outdoor transmission line terminal block (TB3) on the outdoor unit (OC) and that of indoor/outdoor transmission line terminal block (TB5) on each indoor unit (IC). (with non-polarity two wires)

※ When the transmission line is long or noise sources are located near the unit, recommend to use shielded wire.

#### Connection of shielded wire:

For the earth of shielded wire, apply jumper wiring connection between the earth screw of OC and the S-terminal of IC terminal block (TB5).

### b. Centralized control transmission line

Connection is not required.

### c. MA remote controller wiring

Connect the 1, 2 terminals of MA remote controller wiring terminal block (TB15) on IC to the terminal block of MA remote controller (MA). (with non-polarity two wires)

※ MA remote controller can be connected to A-type indoor unit or later.

#### For 2-remote controller operation:

To employ 2-remote controller operation, connect 1, 2 terminals of the terminal block (TB15) on IC to the terminal block of two MA remote controllers.

※ Set the main/sub selector switch of one MA remote controller to the sub remote controller. (For the setting method, see the installation manual of MA remote controller.)

#### For indoor group operation:

For the group operation of IC, connect 1, 2 terminals of the terminal block (TB15) on all ICs within the same group, and connect 1, 2 terminals of the terminal block (TB15) on another IC to the terminals of MA remote controller.

(with non-polarity two wires)

※ To operate the indoor units with different function in the same group, refer to 1. (2).

### d. LOSSNAY connection

Apply jumper wiring to connect M1, M2 terminals of the terminal block (TB5) on IC to the indoor/outdoor transmission terminal block (TB5) on LOSSNAY (LC). (with non-polarity two wires)

※ Linked and registered automatically with all indoor units within a refrigerant system.

※ Please refer to the 1. (2) "Manual address set-up," when interlocking partial indoor units with Lossnay, using Lossnay alone without interlocking, interlocking indoor units and Lossnay for over 16 units within a refrigerant system, or connecting LOSSNAY for over 2 units in a refrigerant system.

### e. Switch setting

Address setting is not required.

Order	Unit or controller			Address setting range	Setting method	Caution	Factory setting
1	Indoor unit	Main unit	IC	Not required	-	• Refer to 1. (2) to operate indoor units with different function in the same group.	00
		Sub unit	IC				
2	LOSSNAY		LC	Not required	-		00
3	MA remote controller	Main unit	MA	Not required	-		Main
		Sub unit	MA	Sub unit	Set with main/sub selector switch.		
4	Outdoor unit		OC	Not required	-		00
5	Sub unit	Hex. unit	OS				



# 1. System using MA remote controller

(2) In the case of single refrigerant system connecting 2 or more LOSSNAY units (Manual address set-up)

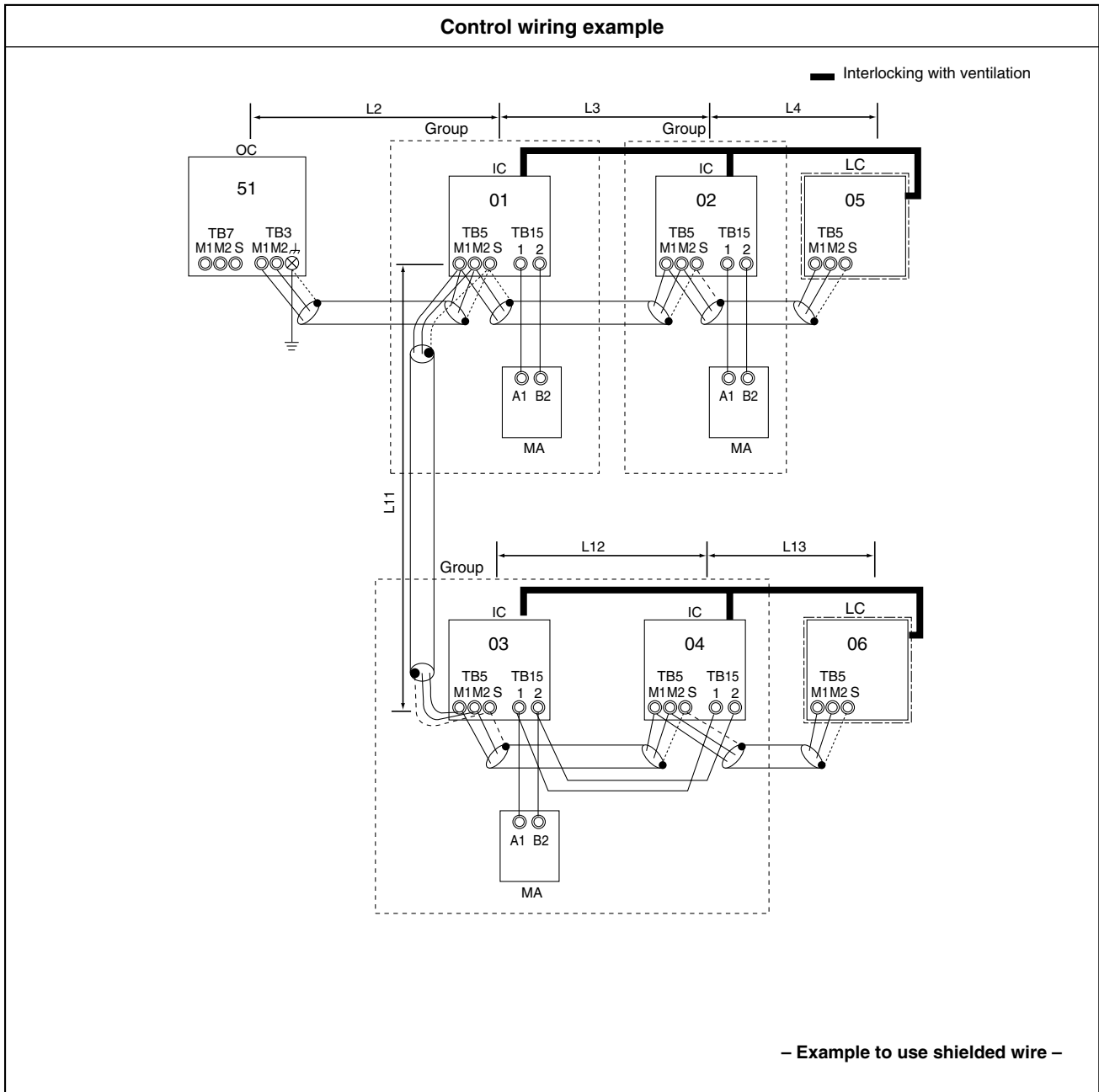

Prohibited items	Allowable length
<ol style="list-style-type: none"> <li>1. M-NET and MA remote controllers can not be connected together to the indoor unit within the same group.</li> <li>2. MA remote controller of 3 units or more can not be connected to the indoor unit within the same group.</li> <li>3. When the total number of indoor units exceeds 26 units including that above Type 200, a transmission booster is required.</li> </ol>	<ol style="list-style-type: none"> <li><b>a. Indoor/outdoor transmission line</b> The same as 1. (1)</li> <li><b>b. Centralized control transmission line</b> No connection is required.</li> <li><b>c. MA remote controller wiring</b> The same as 1. (1)</li> </ol>

## Wiring method • Address setting method

### a. Indoor/outdoor transmission line

The same as 1. (1)

#### Connection of shielded wire:

The same as 1. (1)

### b. Centralized control transmission line

No connection is required.

### c. MA remote controller wiring

The same as 1. (1)

#### For 2-remote controller operation:

The same as 1. (1)

#### For indoor group operation:

The same as 1. (1)

### d. LOSSNAY connection

Apply jumper wiring to connect M1, M2 terminals of the terminal block (TB5) on the indoor unit (IC) to the terminal block (TB5) on Lossnay (LC). (with non-polarity two wires)

※ The interlocking registration of the indoor unit and Lossnay from the remote controller is required. (For the registration method, see the installation manual of remote controllers.)

### e. Switch setting

Address setting is required as listed below.

Order	Unit or controller			Address setting range	Setting method	Caution	Factory setting
1	Indoor unit	Main unit	IC	01 ~ 50	• Set the lowest address within a same group to the indoor unit desired to be the main unit.	• When operating indoor units with different function within a same group, assign the indoor unit with the most plenty of function to the main unit.	00
		Sub unit			Set to the main unit address within a same group in serial order. [Main unit +1, +2, +3, .... ]		
2	LOSSNAY		LC	01 ~ 50	Set any address after setting all indoor units.	• Set the address not to be overlapped with the indoor unit address.	00
3	MA remote controller	Main unit	MA	Not required	-		Main
		Sub unit	MA	Not required	Set with main/sub selector switch.		
4	Outdoor unit		OC	51 ~ 100	The lowest address of indoor unit within refrigerant system + 50	• When setting address to "100," make it "50."	00
5	Sub unit	Hex. unit	OS		Oudoor unit address + 1		

# 1. System using MA remote controller

(3) In the case of different refrigerant grouping operation

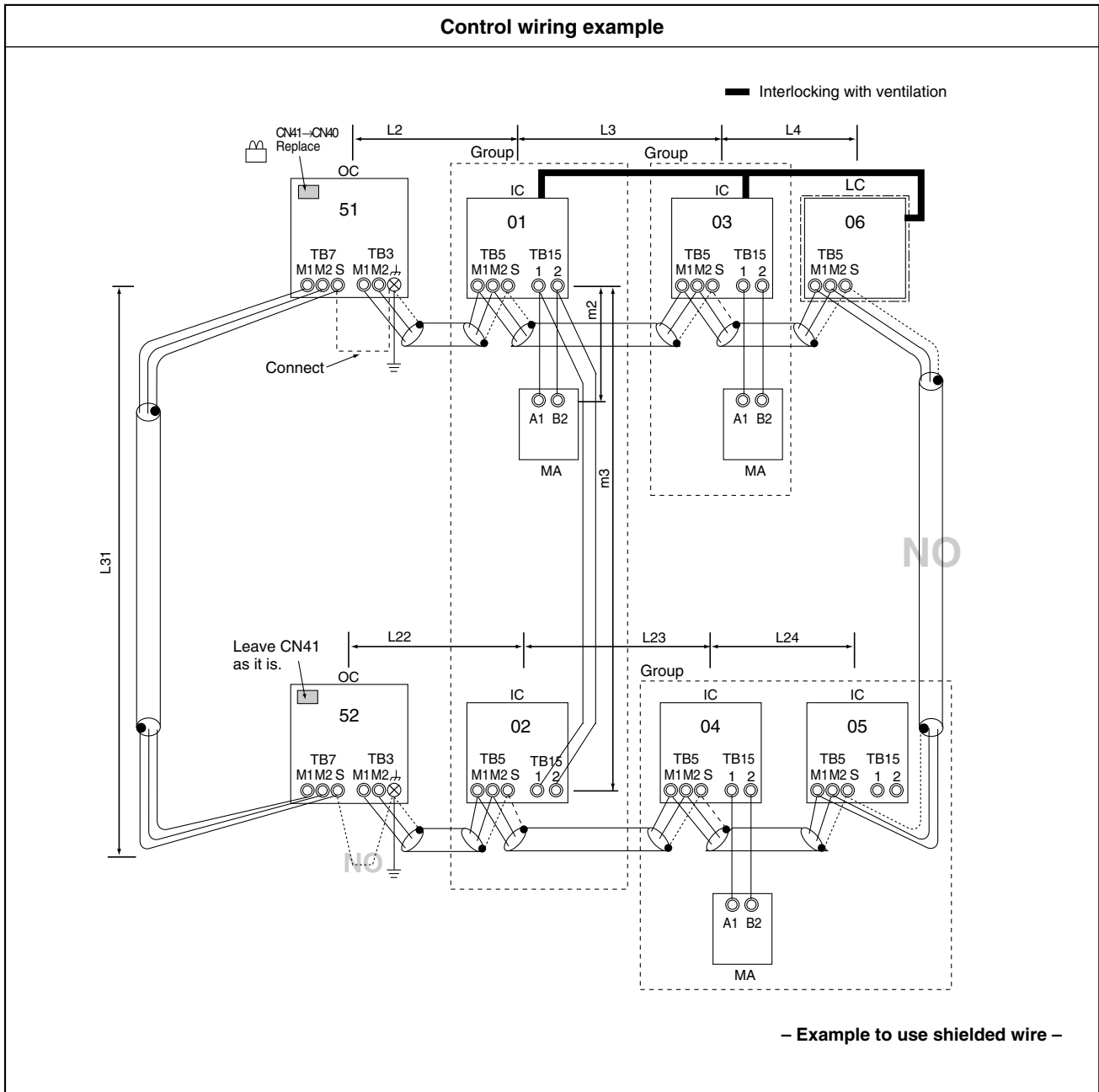

Prohibited items	Allowable length
<ol style="list-style-type: none"> <li>1. M-NET and MA remote controllers can not be connected together to the indoor unit within the same group.</li> <li>2. MA remote controller of 3 units or more can not be connected to the indoor unit within the same group.</li> <li>3. Do not connect together the terminal blocks (TB5) of the indoor unit connected to different outdoor units.</li> <li>4. Replacement of the power supply selecting connector (CN41) on the outdoor unit should be done only on one outdoor unit.</li> <li>5. Grounding of S-terminal of the centralized control terminal block (TB7) on outdoor unit should be done only on one outdoor unit.</li> <li>6. When the total number of indoor units exceeds 26 units including that above Type 200, a transmission booster is required.</li> </ol>	<ol style="list-style-type: none"> <li><b>a. Indoor/outdoor transmission line</b> Farthest length (1.25mm<sup>2</sup> or more)  <math>L2 + L3 + L4 \leq 200\text{m}</math>  <math>L22 + L23 + L24 \leq 200\text{m}</math></li> <li><b>b. Centralized control transmission line</b> Farthest length via outdoor unit (1.25mm<sup>2</sup> or more)  <math>L2 + L3 + L4 + L31 + L22 + L23 + L24 \leq 500\text{m}</math></li> <li><b>c. MA remote controller wiring</b> The same as 1. (1)</li> </ol>

## Wiring method • Address setting method

### a. Indoor/outdoor transmission line

Apply jumper wiring connection between M1, M2 terminals of the indoor/outdoor transmission line terminal block (TB3) on the outdoor unit (OC) and that of indoor/outdoor transmission line terminal block (TB5) on each indoor unit (IC). (with non-polarity two wires)

※ Make sure to use shielded wire.

#### Connecting of shielded wire:

The same as 1. (1)

### b. Centralized control transmission line

Apply jumper wiring between M1, M2 terminals of centralized control transmission line terminal blocks (TB7) on each OC. For one OC only, replace the power selecting connector (CN41) with (CN40).

※ Make sure to use shielded wire.

#### Connecting of shielded wire:

Apply jumper wiring to connect the shielded earth to S-terminal of the terminal block (TB7) on each OC. Connect S-terminal of the terminal block (TB7) on the one OC with (CN40) replaced to the earth screw (⏏) of the electrical parts box.

### c. MA remote controller wiring

The same as 1. (1)

#### For 2-remote controller operation:

The same as 1. (1)

#### For indoor unit group operation:

The same as 1. (2)

### d. LOSSNAY connection

The same as 1. (2)

### e. Switch setting

Address setting is required as follows.

Order	Unit or controller		Address setting range	Setting method	Caution	Factory setting
1	Indoor unit	Main unit	IC	01 ~ 50	• Set the lowest address within a same group to the indoor unit desired to be the main unit.	00
		Sub unit			Set to the main unit address within a same group in serial order. [Main unit +1, +2, +3, .... ]	
2	LOSSNAY		LC	01 ~ 50	Set any address after setting all indoor units.	• Set the address not to be overlapped with the indoor unit address. 00
3	MA remote controller	Main unit	MA	Not required	–	Main
		Sub unit	MA	Sub unit	Set by the main/sub selector switch.	
4	Outdoor unit		OC	51 ~ 100	The lowest address of indoor unit within refrigerant system + 50	• When setting address to "100," make it "50." 00
5	Sub unit	Hex. unit	OS		Outdoor unit address + 1	

# 1. System using MA remote controller

(4) In the case of connecting system controller to centralized control transmission line

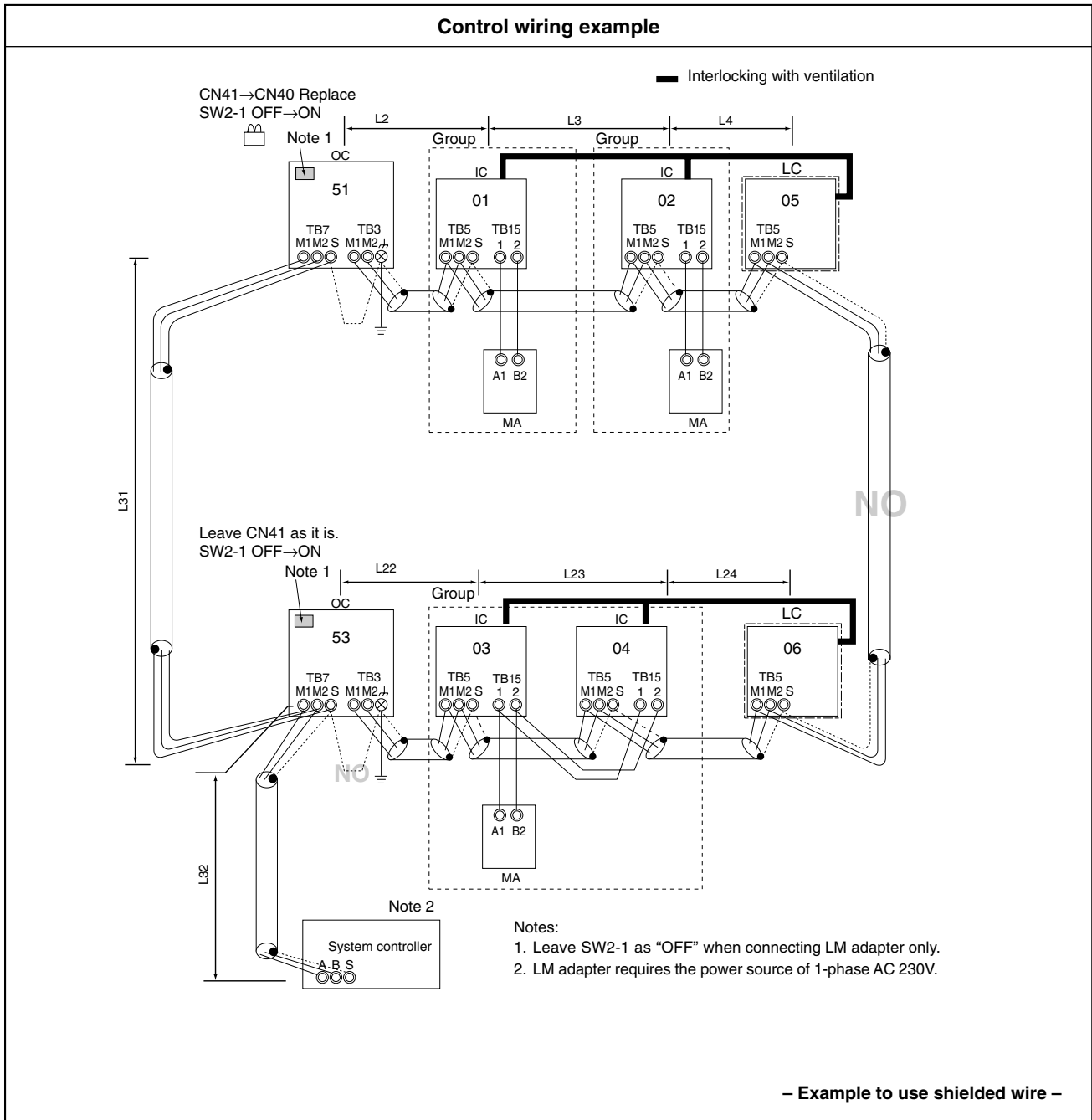

Prohibited items	Allowable length
<ol style="list-style-type: none"> <li>1. M-NET and MA remote controllers can not be connected together to the indoor unit within the same group.</li> <li>2. MA remote controller of 3 units or more can not be connected to the indoor unit within the same group.</li> <li>3. Do not connect together the terminal blocks (TB5) of the indoor unit connected to different outdoor units.</li> <li>4. Replacement of the power supply selecting connector (CN41) on the outdoor unit should be done only on one outdoor unit.</li> <li>5. Grounding work is required for S-terminal of the centralized control transmission block (TB7) on one outdoor unit only.</li> <li>6. When the total number of indoor units exceeds 26 units including that above Type 200, a transmission booster is required.</li> </ol>	<ol style="list-style-type: none"> <li><b>a. Indoor/outdoor transmission line</b> The same as 1. (3)</li> <li><b>b. Centralized control transmission line</b> Farthest length via outdoor unit (1.25mm<sup>2</sup> or more)  <math>L32 + L31 + L2 + L3 + L4 \leq 500\text{m}</math>  <math>L32 + L22 + L23 + L24 \leq 500\text{m}</math>  <math>L2 + L3 + L4 + L31 + L22 + L23 + L24 \leq 500\text{m}</math> </li> <li><b>c. MA remote controller wiring</b> The same as 1. (1)</li> </ol>

## Wiring method • Address setting method

### a. Indoor/outdoor transmission line

The same as 1. (3)

#### Connection of shielded wire:

The same as 1. (1)

### b. Centralized control transmission line

Apply jumper wiring between M1, M2 terminals of centralized control transmission line terminal blocks (TB7) on each OC. On one OC only, replace the power selecting connector (CN41) with (CN40). Set the centralized control switch (SW2-1) on the main board of all outdoor units to “ON.”

※ Make sure to use shielded wire.

#### Connection of shielded wire:

Apply jumper wiring to connect the shielded earth to S-terminal of the terminal block (TB7) on each OC. Connect S-terminal of the terminal block (TB7) on one OC with (CN40) connected to the earth screw (⏏) of the electrical parts box.

### c. MA remote controller wiring

The same as 1. (1)

#### For 2-remote controller operation:

The same as 1. (1)

#### For indoor group operation:

The same as 1. (1)

### d. LOSSNAY connection

Apply jumper wiring to connect M1, M2 terminals of the terminal block (TB5) on (IC) to the terminal block (TB5) on the indoor/outdoor transmission line terminal block (TB5) on Lossnay (LC). (with non-polarity two wires)

※ The interlocking registration of the indoor unit and LOSSNAY from the system controller is required. (For the registration method, see the installation manual of the system remote controllers.)

When connecting ON/OFF remote controller and LM adaptor only, the interlocking registration from the remote controller is required.

### e. Switch setting

Address setting is required as listed below.

Order	Unit or controller		Address setting range	Setting method	Caution	Factory setting
1	Indoor unit	Main unit	IC	01 ~ 50	<ul style="list-style-type: none"> <li>Set the lowest address within a same group to the indoor unit desired to be the main unit.</li> <li>Set to the main unit address within a same group in serial order. [Main unit +1, +2, +3, .... ]</li> </ul>	00
		Sub unit				
2	LOSSNAY		LC	01 ~ 50	<ul style="list-style-type: none"> <li>Set any address after setting all indoor units.</li> <li>Set the address not to be overlapped with the indoor unit address.</li> </ul>	00
3	MA remote controller	Main unit	MA	Not required	–	Main
		Sub unit	MA	Sub unit	Set by the main/sub selector switch.	
4	Outdoor unit		OC	51 ~ 100	<ul style="list-style-type: none"> <li>The lowest address of indoor unit within refrigerant system + 50</li> <li>When setting address to “100,” make it “50.”</li> </ul>	00
5	Sub unit	Hex. unit	OS			

# 1. System using MA remote controller

(5) In the case of connecting system controller to indoor/outdoor transmission line (excluding LM adaptor)

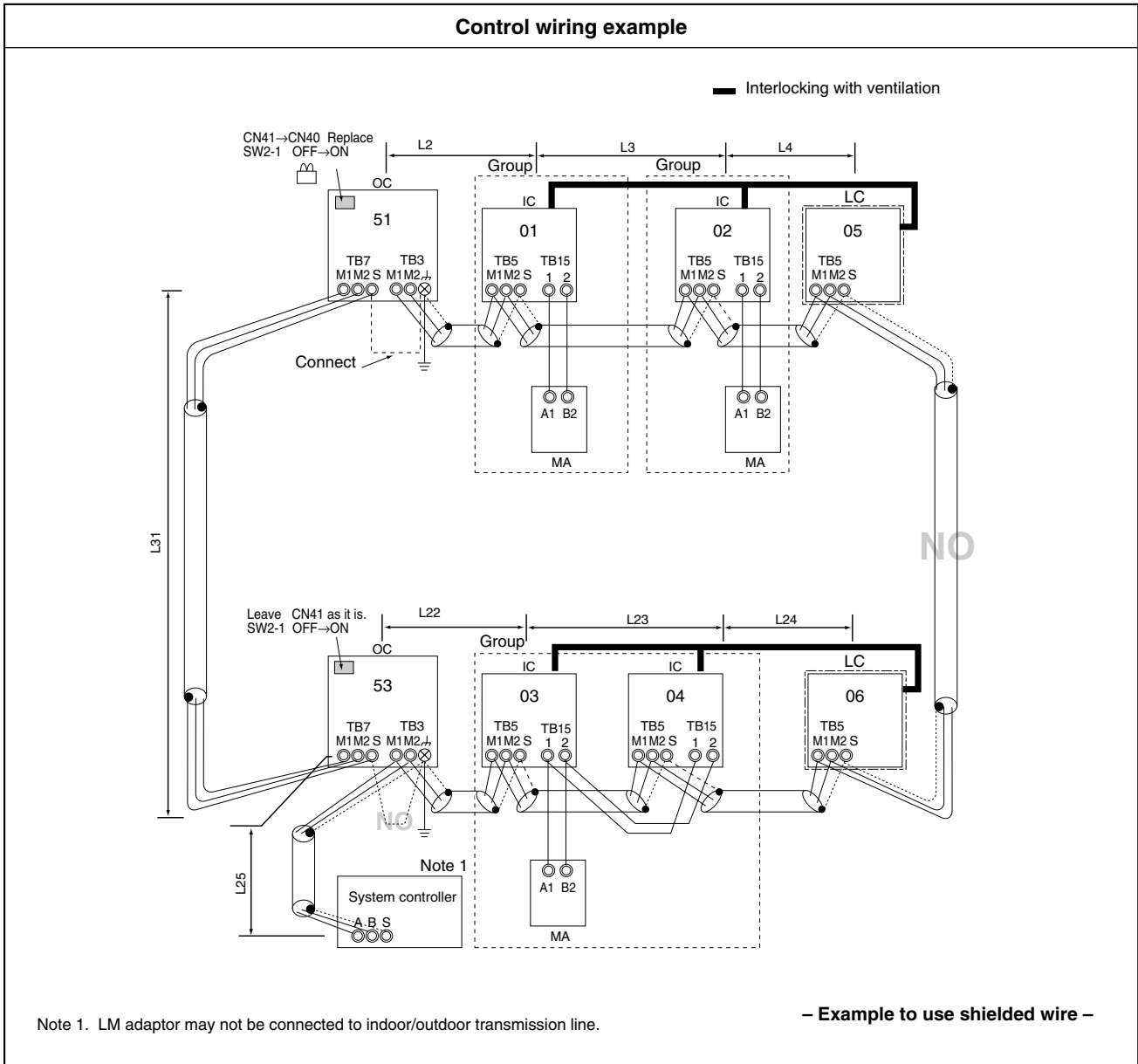

Prohibited items	Allowable length
<ol style="list-style-type: none"> <li>1. M-NET and MA remote controllers can not be connected together to the indoor unit within the same group.</li> <li>2. MA remote controller of 3 units or more can not be connected to the indoor unit within the same group.</li> <li>3. Do not connect together the terminal blocks (TB5) of the indoor unit connected to different outdoor units.</li> <li>4. Replacement of the power supply selecting connector (CN41) on the outdoor unit should be done only on one outdoor unit.</li> <li>5. Grounding work is required for S-terminal of the centralized control transmission block (TB7) on one outdoor unit only.</li> <li>6. The system controller connectable to the indoor/outdoor transmission line counts for 3 sets maximum. While G-50 counts for only 1 set</li> <li>7. When the total number of indoor units exceeds 26 sets, the system controller may not be connected to the indoor/outdoor transmission line.</li> <li>8. When the total number indoor units exceed 18 sets and they includes Type 200 or above, the system controller may not be connected to the indoor/outdoor transmission line.</li> </ol>	<ol style="list-style-type: none"> <li><b>a. Indoor/outdoor transmission line</b>                      Farthest length (1.25mm<sup>2</sup> or more)  <math>L2 + L3 + L4 \leq 200m</math>  <math>L22 + L23 + L24 \leq 200m</math>  <math>L25 \leq 200m</math> </li> <li><b>b. Centralized control transmission line</b>                      Farthest length via outdoor unit (1.25mm<sup>2</sup> or more)  <math>L25 + L31 + L2 + L3 + L4 \leq 500m</math>  <math>L2 + L3 + L4 + L31 + L22 + L23 + L24 \leq 500m</math> </li> <li><b>c. MA remote controller wiring</b>                      The same as 1. (1)                 </li> </ol>

## Wiring method • Address setting method

### a. Indoor/outdoor transmission line

Apply jumper wiring connection between M1, M2 terminals of the indoor/outdoor transmission line terminal block (TB3) on the outdoor unit (OC) and that of indoor/outdoor transmission line terminal block (TB5) on each indoor unit (IC). (with non-polarity two wires)

※ Make sure to use shielded wire.

#### Connection of shielded wire:

For the grounding of shielded wire, apply jumper wiring between the grounding screw of OC, S-terminal of the terminal block (TB3), and S-terminal of the system controller.

### b. Centralized control transmission line

Apply jumper wiring between M1, M2 terminals of centralized control transmission line terminal blocks (TB7) on each OC. On one OC only, replace the power selecting connector (CN41) with (CN40). Set the centralized control switch (SW2-1) on the main board of all outdoor units to "ON."

※ Make sure to use shielded wire.

#### Connection of shielded wire:

Apply jumper wiring to connect the shielded earth to S-terminal of the terminal block (TB7) on each OC. Connect S-terminal of the terminal block (TB7) on one OC with (CN40) connected to the earth screw (⏏) of the electrical parts box.

### c. MA remote controller wiring

The same as 1. (1)

#### For 2-remote controller operation:

The same as 1. (1)

#### For indoor unit group operation:

The same as 1. (2)

### d. LOSSNAY connection

Apply jumper wiring to connect A, B terminals of the terminal block (TB5) on (IC) to the terminal block (TB5) on the indoor/outdoor transmission line terminal block (TB5) on Lossnay (LC). (with non-polarity two wires)

※The interlocking registration of the indoor unit and Lossnay is required from the system controller. (For the registration method, see the instruction manual of system controller.)

To connect ON/OFF remote controller only, interlocking registration from the remote controller is required.

### e. Switch setting

Address setting is required as follows.

Order	Unit or controller		Address setting range	Setting method	Caution	Factory setting
1	Indoor unit	Main unit	IC	01 ~ 50	<ul style="list-style-type: none"> <li>Set the lowest address within a same group to the indoor unit desired to be the main unit.</li> <li>Set to the main unit address within a same group in serial order. [Main unit +1, +2, +3,]</li> </ul>	00
		Sub unit				
2	LOSSNAY		LC	01 ~ 50	<ul style="list-style-type: none"> <li>Set any address after setting all indoor units.</li> <li>Set the address not to be overlapped with the indoor unit address.</li> </ul>	00
3	MA remote controller	Main unit	MA	Not required	–	Main
		Sub unit	MA	Sub unit	Set by the main/sub selector switch	
4	Outdoor unit		OC	51 ~ 100	<ul style="list-style-type: none"> <li>The lowest address of indoor unit within refrigerant system + 50</li> <li>When setting address to "100," make it "50."</li> </ul>	00
5	Sub unit	Hex. unit	OS			



## 2. System Using the M-NET Remote Controller

(1) System with the system controller connected to the transmission lines for centralized control

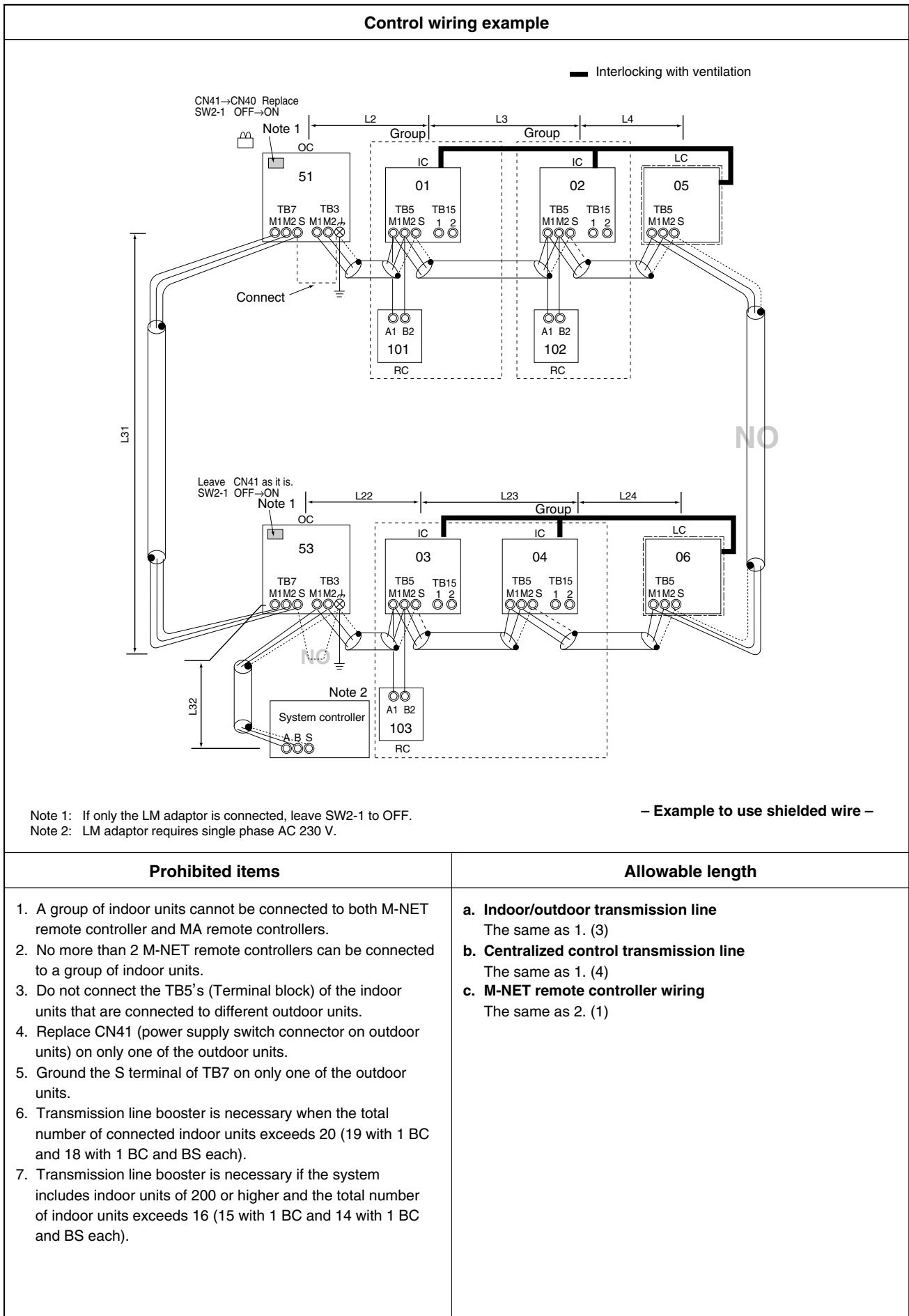

## Wiring method • Address setting method

### a. Indoor/outdoor transmission line

The same as 1. (3)

#### Connection of shielded wire:

The same as 1. (1)

### b. Centralized control transmission line

The same as 1. (4)

#### Connection of shielded wire:

The same as 1. (4)

### c. M-NET remote controller wiring

M-NET remote controller wiring

Connect each of the M1 and M2 terminals of TB5 (indoor/outdoor transmission line terminal block) on the IC to the terminals on the M-NET remote controller.

#### For 2-remote controller operation:

For a 2-remote-controller operation, connect each of the terminals M1 and M2 of the IC terminal block to the two RC terminal blocks respectively.

#### For indoor unit group operation:

Indoor unit group operation

To operate IC's as a group, connect the M1, M2 terminals of the terminal block on the main IC in the group with the RC terminal block (with non-polar two wires)

※M-NET remote controller can be connected at any point on the indoor/outdoor transmission line.

※To run a group operation of indoor units that have different functions, select the unit with the greatest number of functions as the main unit.

### d. LOSSNAY connection

The same as 1. (4)

### e. Switch setting

Address setting is required as follows.

Order	Unit or controller		Address setting range	Setting method	Caution	Factory setting	
1	Indoor unit	Main unit	IC	01 ~ 50	<ul style="list-style-type: none"> <li>Assign the smallest address within the group to the indoor unit to become the main unit.</li> <li>Starting with the number main unit address +1, assign a sequential number to each of the rest of the indoor units.</li> </ul>	<ul style="list-style-type: none"> <li>Make the initial setting of the indoor unit group setting with the system controller (MELANS).</li> </ul>	00
		Sub unit					
2	LOSSNAY		LC	01 ~ 50	<ul style="list-style-type: none"> <li>After all indoor units have received an address, use any remaining number and assign it to the Lossnay unit. units.</li> <li>The Lossnay address must not overlap with the indoor unit address.</li> </ul>	00	
3	M-NET remote controller	Main unit	RC	101 ~ 150	The address of the main unit in the same group +100	<ul style="list-style-type: none"> <li>100's digit does not need to be set.</li> <li>Set the address to "00" when setting it to "200".</li> </ul>	101
		Sub unit	RC	151 ~ 200	The address of the main unit in the same group +150		
4	Outdoor unit		OC	51 ~ 100	The smallest indoor unit address in the same refrigerant system +50	<ul style="list-style-type: none"> <li>Set the address to "50" when setting it to "100".</li> </ul>	00
5	Sub unit	Hex. unit					

### 3. System where MA remote controller and M-NET remote controller coexist

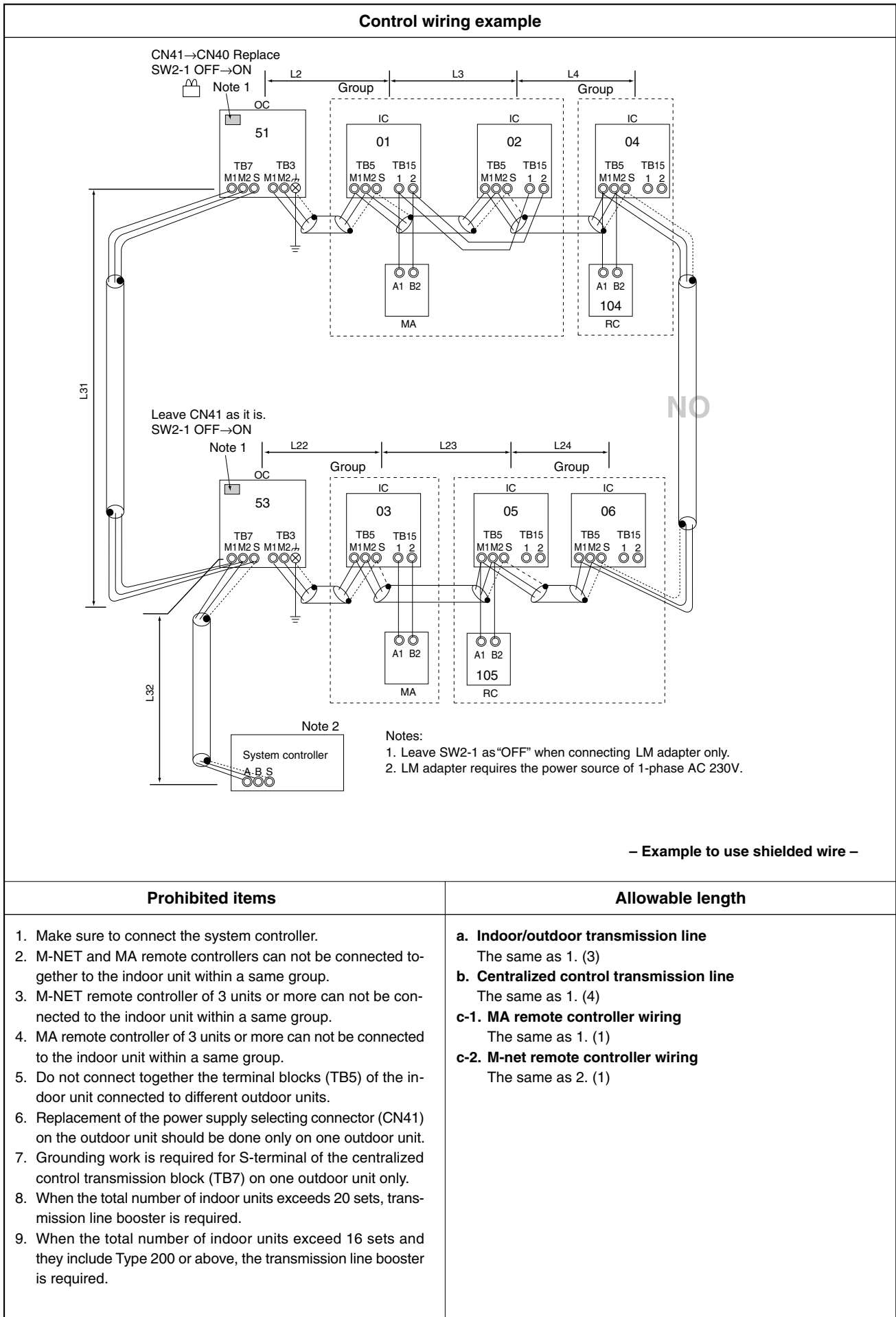

### Wiring method · Address setting method

**a. Indoor/outdoor transmission line**

The same as 1. (3)

**Connection of shielded wire:**

The same as 1. (1)

**b. Centralized control transmission line**

The same as 1. (4)

**Connection of shielded wire:**

The same as 1. (4)

**c-1. MA remote controller wiring, For 2-remote controller operation: , For indoor unit group operation:**

The same as 1. (1)

**c-2. M-NET remote controller, For 2-remote controller operation: , For indoor unit group operation:**

The same as 2. (1)

**d. Lossnay connection**

The same as 1. (4)

**e. Switch setting**

Address setting is required as follows.

Order	Unit or controller				Address setting range	Setting method	Caution	Factory setting
1	Operation with MA remote controller	Indoor unit	Main unit	IC	01 ~ 50	• Set the lowest address within a same group to the indoor unit desired to be the main unit.	• Set lower address than that of the indoor unit connected to M-NET remote controller. • Initially set the same setting detail as that of indoor unit group executed in the wiring of MA remote controller with system controller.	00
			Sub unit			Set to the main unit address within a same group in serial order. [Main unit +1, +2, +3,]		
		MA remote controller	Main unit	MA	Not required	—		Main
			Sub unit	MA	Sub remote controller	Set by using the main/sub selector switch		
2	Operation with M-NET remote controller	Indoor unit	Main unit	IC	01 ~ 50	• After setting the address of the indoor unit to be operated with MA controller, set the lowest address among the same group to the indoor unit desired to be the main unit.	• Initially set the same setting detail as that of indoor unit group with system controller.	00
			Sub unit			Set to the main unit address within a same group in serial order. [Main unit +1, +2, +3,]		
		M-NET remote controller	Main unit	RC	101 ~ 150	Main unit address inside a same group + 100	• 100 digits are not required to set. • When setting the address as "200," make it "00."	101
			Sub unit	RC	151 ~ 200	Main unit address inside a same group + 150		
3	Lossnay			LC	01 ~ 50	After setting all indoor units, set any address.	• Set so that not duplicating with the indoor unit addresses.	00
4	Outdoor unit			OC	51 ~ 100	The lowest address of indoor unit within refrigerant system + 50	• When setting address to "100," make it "50."	00
5	Sub unit	Hex. unit	OS	OOutdoor unit address + 1				

## [4] Restrictions on Refrigerant Piping Length

For the piping connection, the end branching system is applied where the end of refrigerant piping from the outdoor unit is branched and connected to each indoor unit. As the piping connection method, the indoor unit is applied with flare connection, outdoor unit gas piping is flange connection, and liquid piping is flare connection. For the branching, brazed connection is applied.

### ⚠ Warning

Be careful not to leak refrigerant gas (R410A) near a fire. Refrigerant gas if touched a fire of gas oven and the like will be decomposed to generate poisonous gas leading to gas-poisoning. Do not conduct welding work in a closed room. Run a gas leak test after completing refrigerant piping work.

### ⚠ Warning

**Do not use a refrigerant other than that indicated on the equipment at installation or movement.**

- Mixing of different refrigerant or air makes the refrigeration cycle abnormal causing breakage and the like.

### ⚠ Caution

**Use refrigerant piping phosphorus deoxidized copper. In addition, be sure that the inner and outer surface of the pipes are clean and free of hazardous sulphur, oxides, dust/dirt, shaving particles, oils, moisture, or any other contaminant.**

- Contaminants on the inside of the refrigerant piping may cause the refrigerant residual oil to deteriorate.

### ⚠ Caution

**Use liquid refrigerant to fill the system.**

- If gas refrigerant is used to seal the system, the composition of the refrigerant in the cylinder will change and performance may drop.

### ⚠ Caution

**Do not use existing refrigerant piping.**

- The old refrigerant and refrigerator oil in the existing piping contains a large amount of chlorine which may cause the refrigerant oil of the new unit to deteriorate.

### ⚠ Caution

**Store the piping to be used during installation indoors and keep both ends of the piping sealed until just before brazing. (Store elbows and other joints in a plastic bag.)**

- If dust, dirt, or water enters the refrigerant cycle, deterioration of the oil and compressor trouble may result.

### ⚠ Caution

**Do not use a charging cylinder.**

- Using a charging cylinder may cause the refrigerant to deteriorate.

## 1. Line branching system

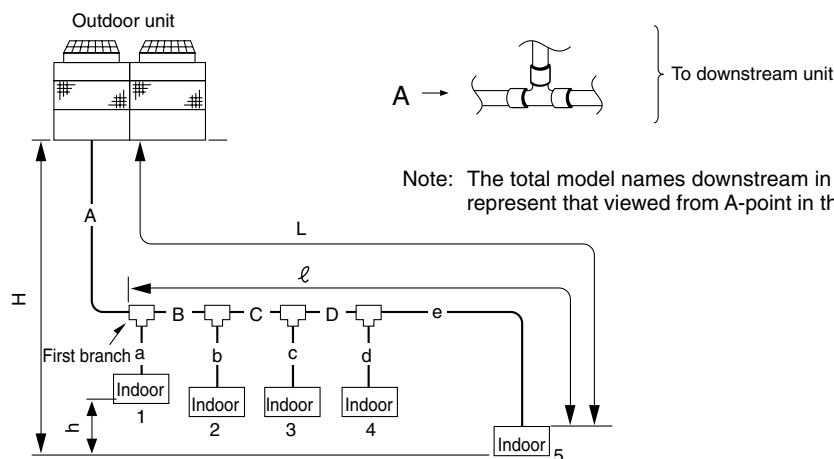

Item		Piping section	Allowable value
Length	Total piping length	$A + B + C + D + a + b + c + d + e$	Less than 300m
	Farthest piping length (L)	$A + B + C + D + e$	Less than 150m
	Farthest piping length after first branch ( $\ell$ )	$B + C + D + e$	Less than 40m
Height difference	Indoor – Outdoor	Upper outdoor unit	H
		Lower outdoor unit	H'
	Indoor – Indoor	h	Less than 15m

## 2. Header branching system

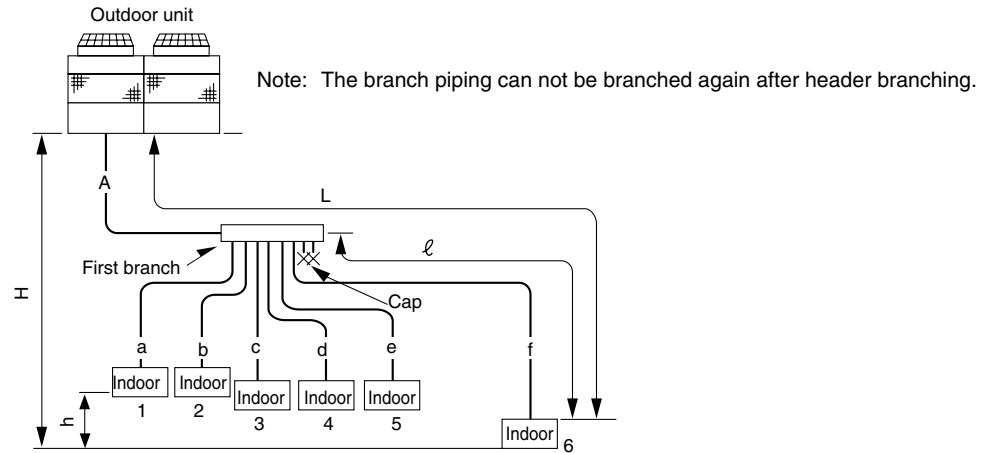

Item		Piping section	Allowable value	
Length	Total piping length	$A + a + b + c + d + e + f$	Less than 300m	
	Farthest piping length (L)	$A + f$	Less than 150m	
	Farthest piping length after first branch ( $\ell$ )	$f$	Less than 40m	
Height difference	Indoor – Outdoor	Upper outdoor unit	H	Less than 50m
		Lower outdoor unit	H'	Less than 40m
	Indoor – Indoor	$h$	Less than 15m	

## 3. Mixed line and header branching system

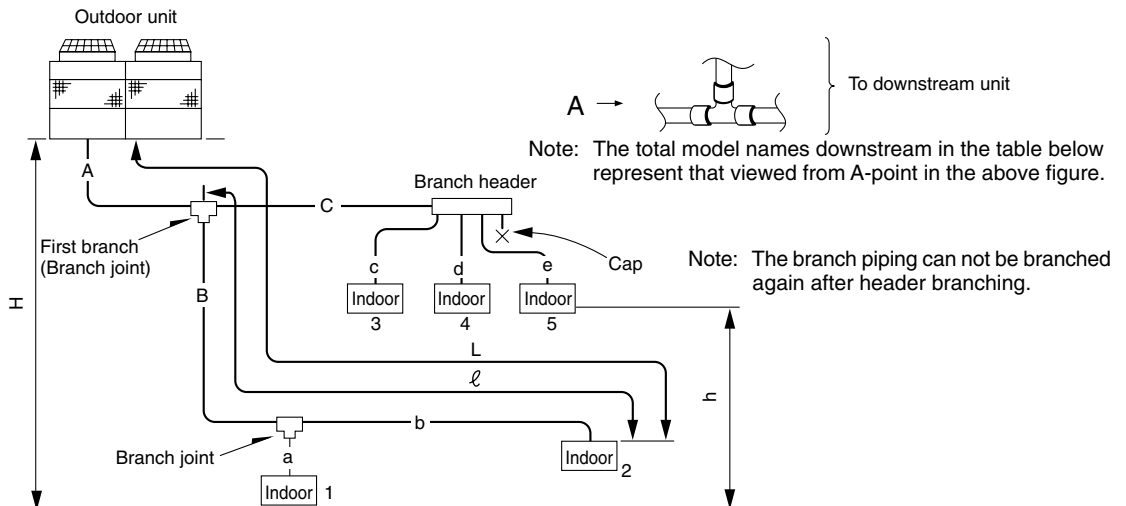

Item		Piping section	Allowable value	
Length	Total piping length	$A + B + C + a + b + c + d + e$	Less than 300m	
	Farthest piping length (L)	$A + B + b$	Less than 150m	
	Farthest piping length after first branch ( $\ell$ )	$B + b$	Less than 40m	
Height difference	Indoor – Outdoor	Upper outdoor unit	H	Less than 50m
		Lower outdoor unit	H'	Less than 40m
	Indoor – Indoor	$h$	Less than 15m	

### 3 Components of the Outdoor Unit

#### [1] Appearance of the Components and Refrigerant Circuit

< P200, P250, P300, P350-Types >

[ Front view of the unit ]

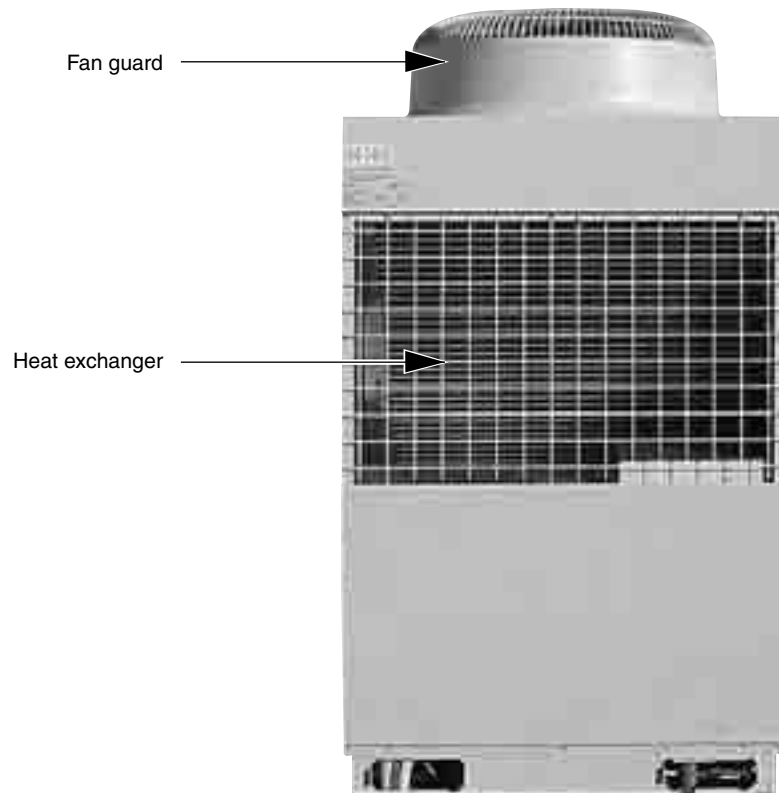

[ Rear view of the unit ]

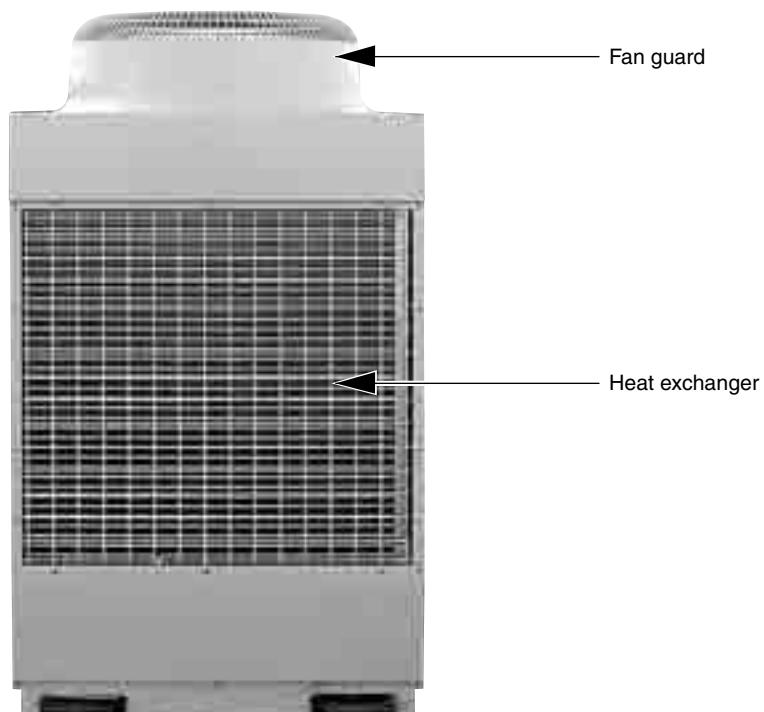

< P200, P250, P300, P350-Types >

[ Front view of the refrigerant circuit ]

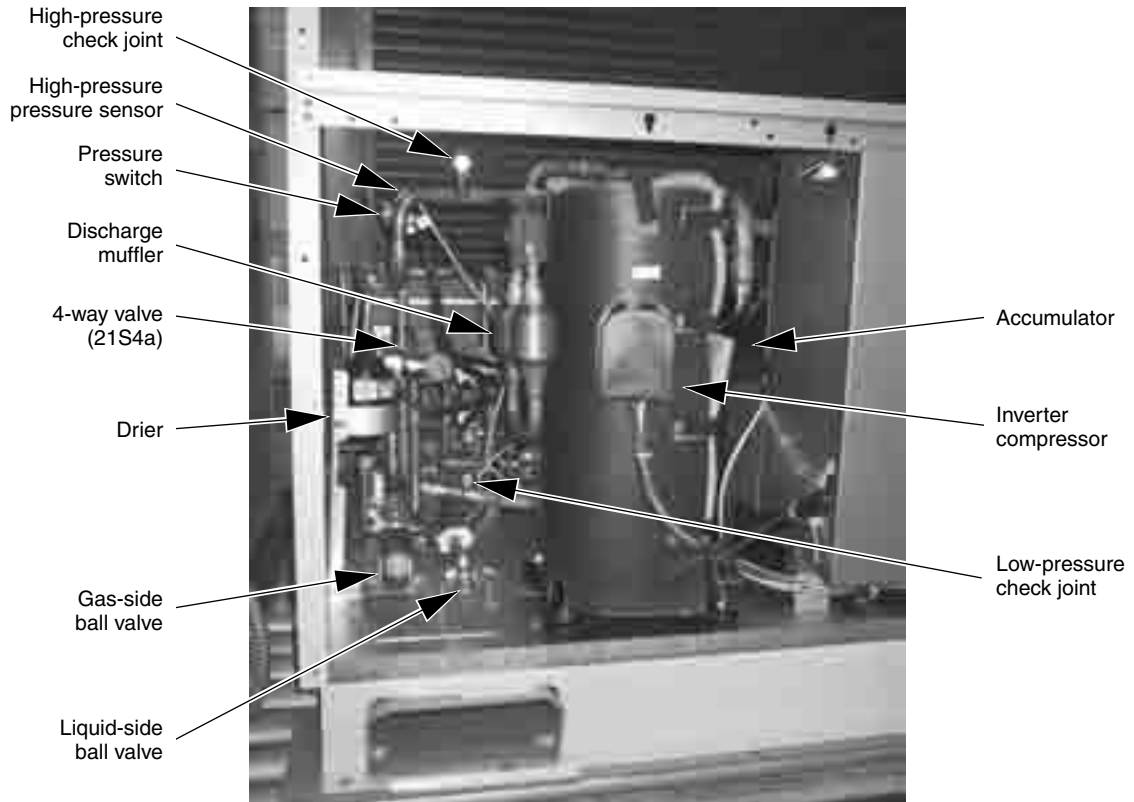

[ Rear view of the refrigerant circuit ]

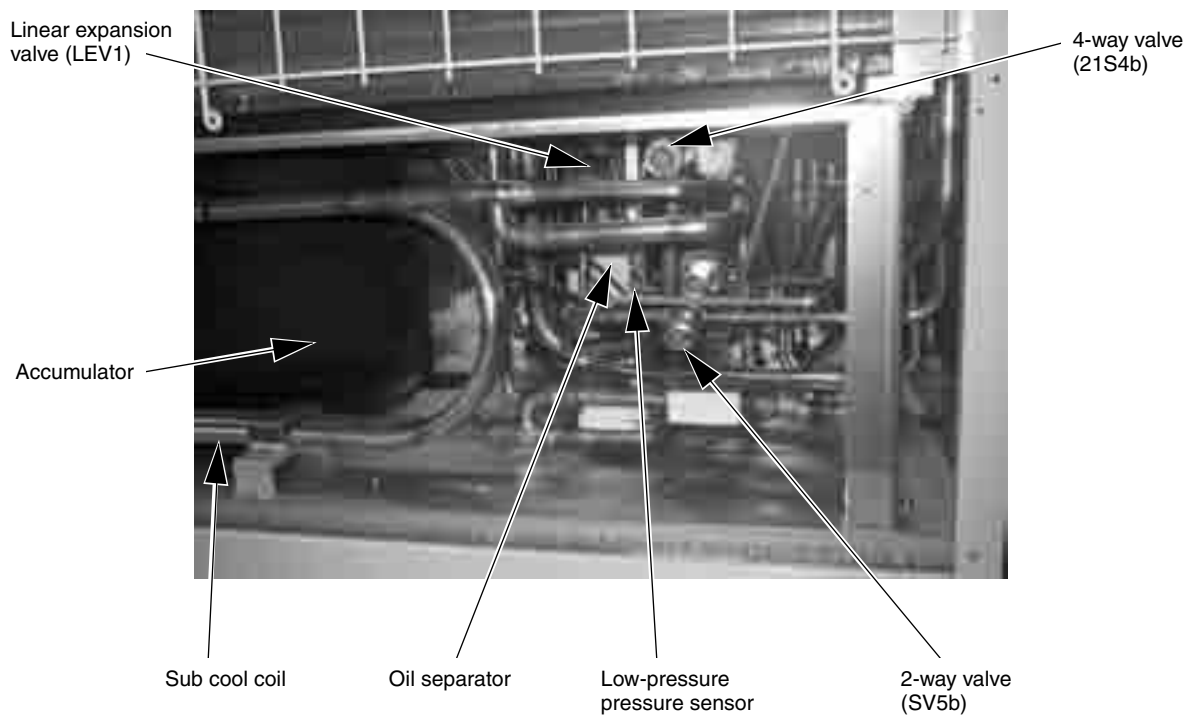



< P400-type >

[ Front view of the unit ]

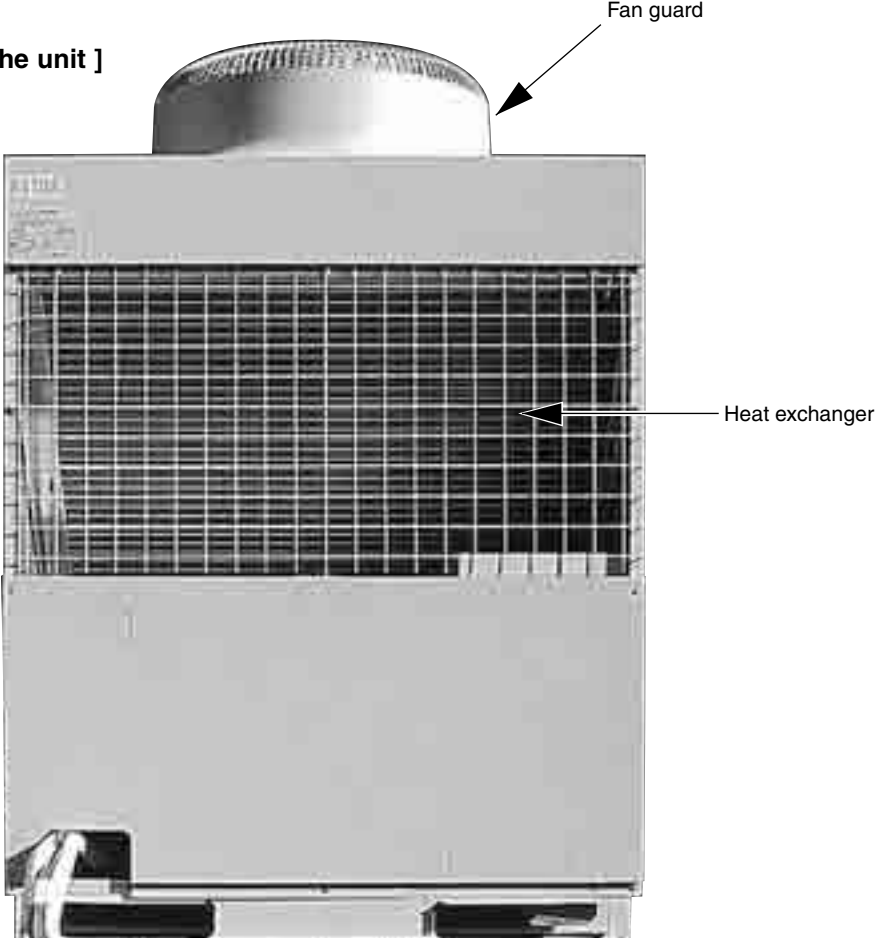

[ Rear view of the unit ]

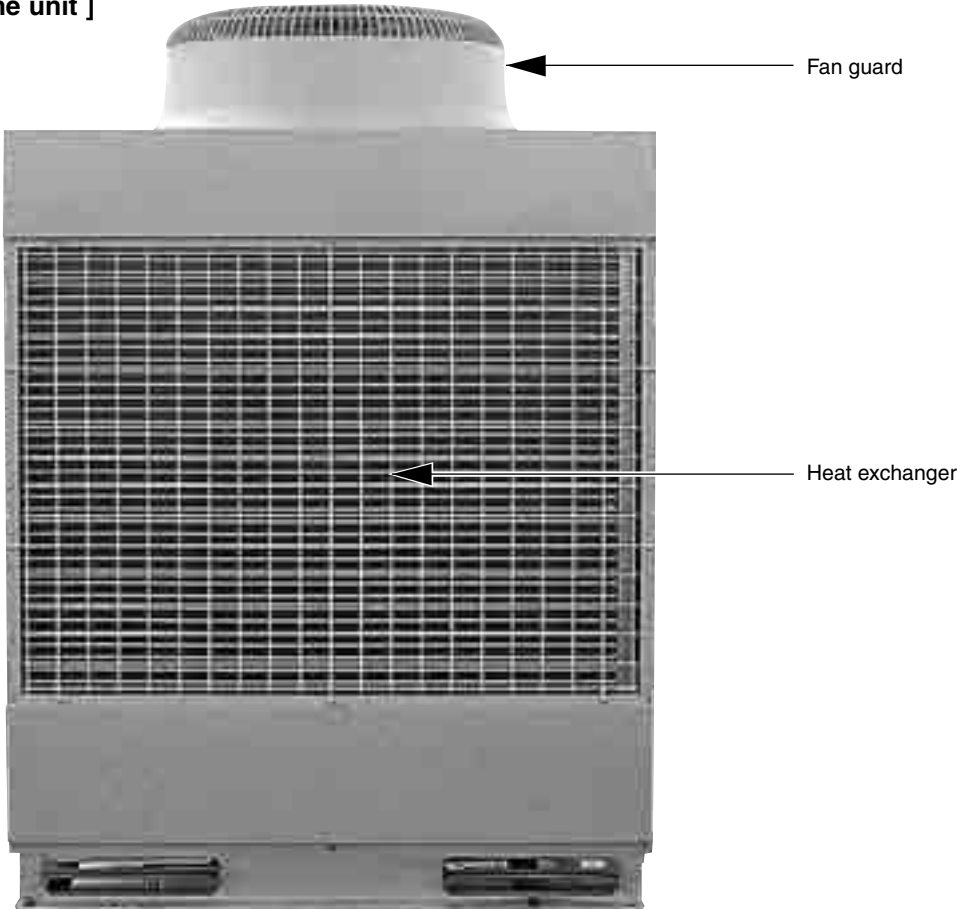

< P400-type >

[ Front view of the refrigerant circuit ]

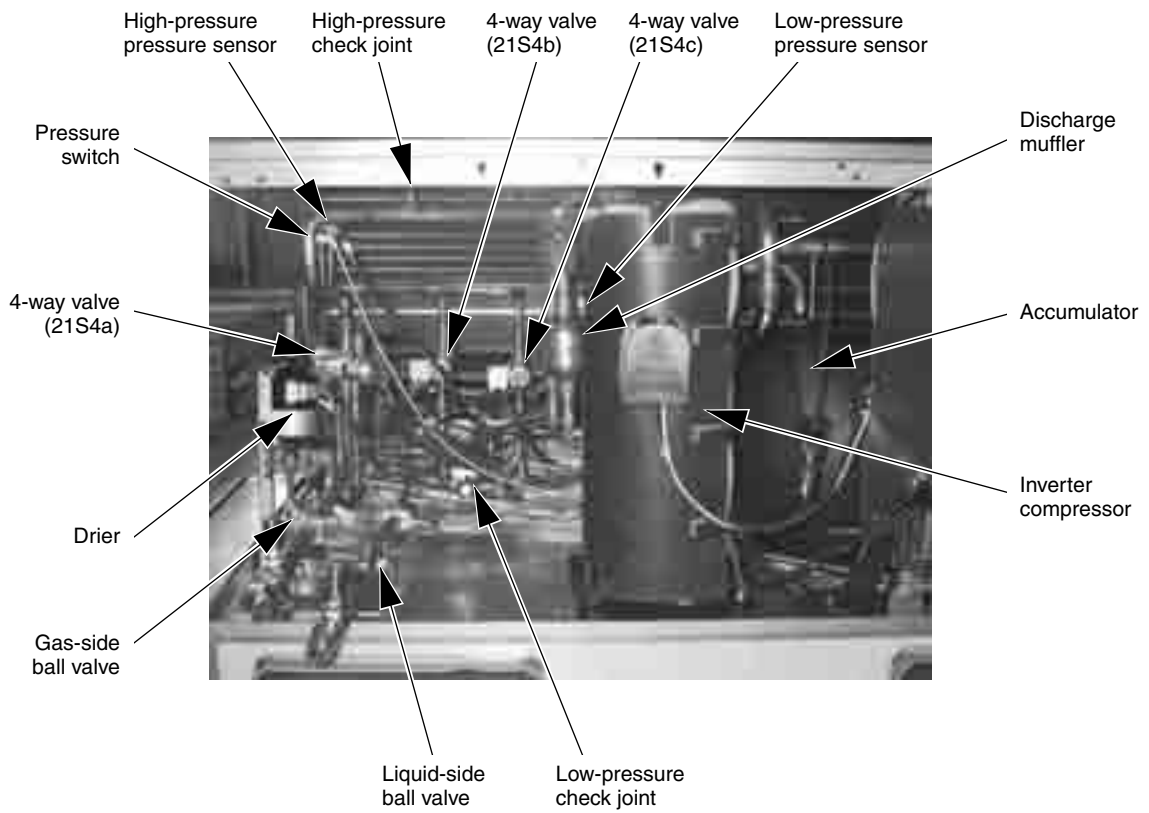

[ Rear view of the refrigerant circuit ]

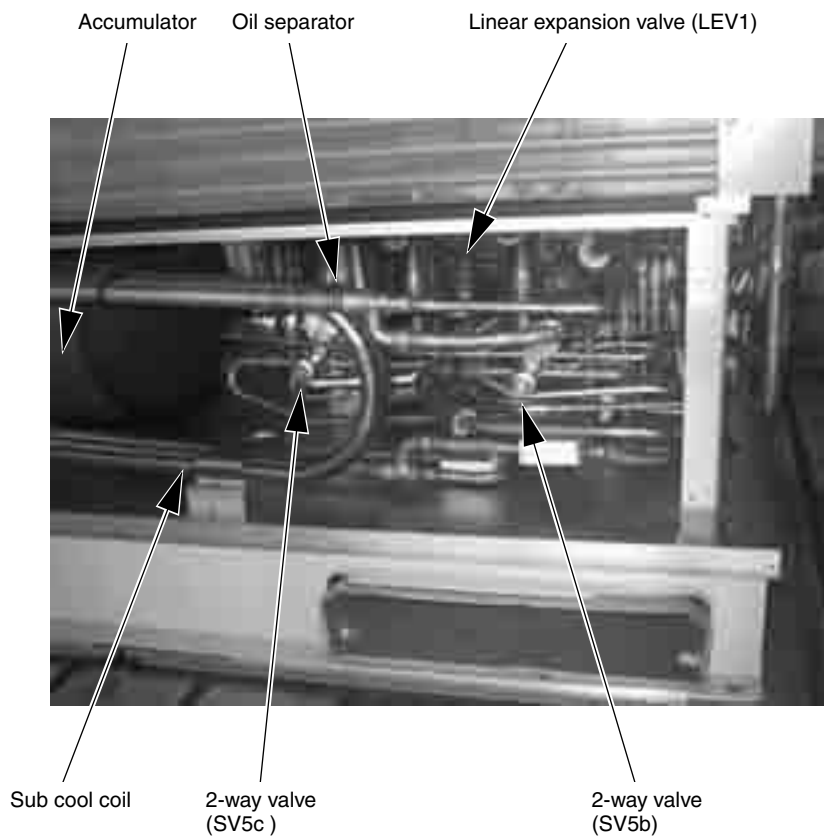

< P450, P500, P550, P600, P650-Types >

[ Front view of the unit ]

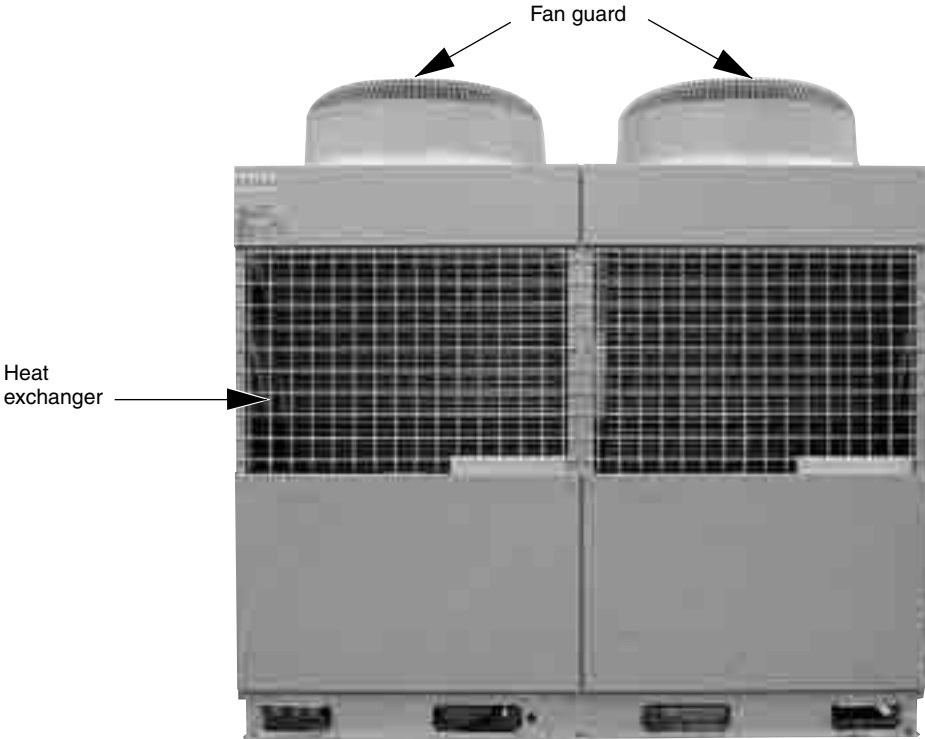

[ Rear view of the unit ]

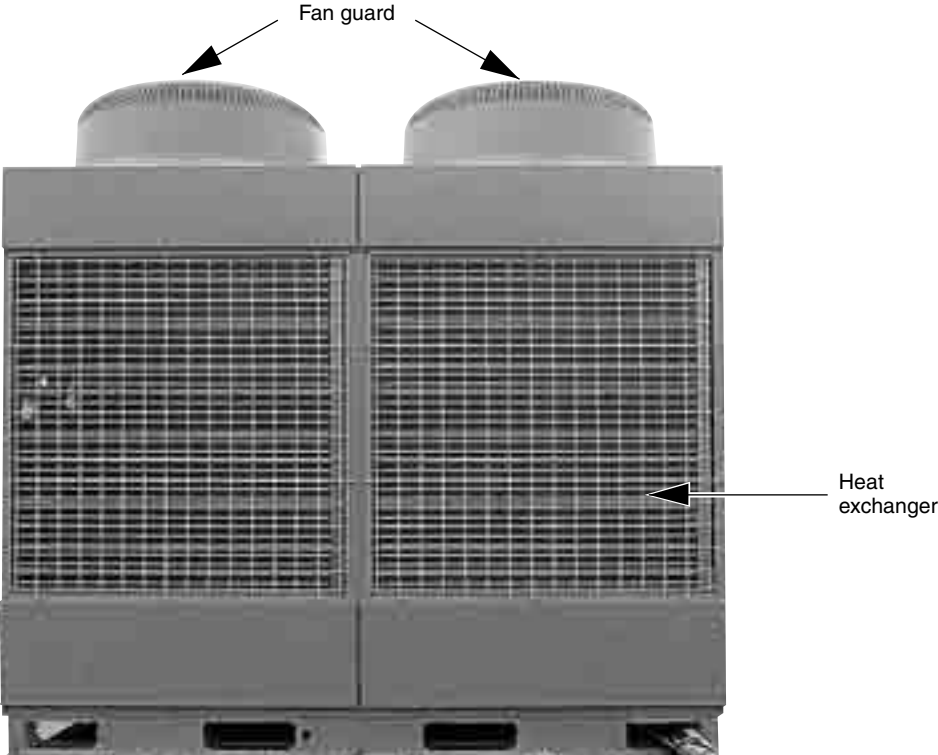

< P450, P500, P550, P600, P650-Types >

[ Front view of the refrigerant circuit ]

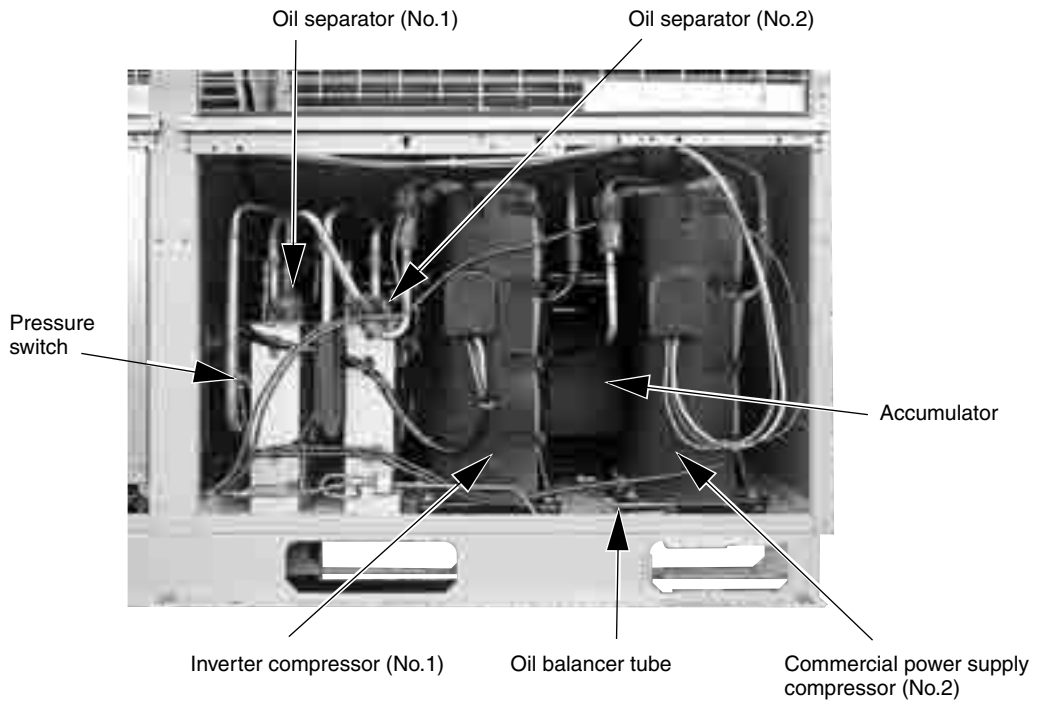

[ Rear view of the refrigerant circuit ]

(Front)

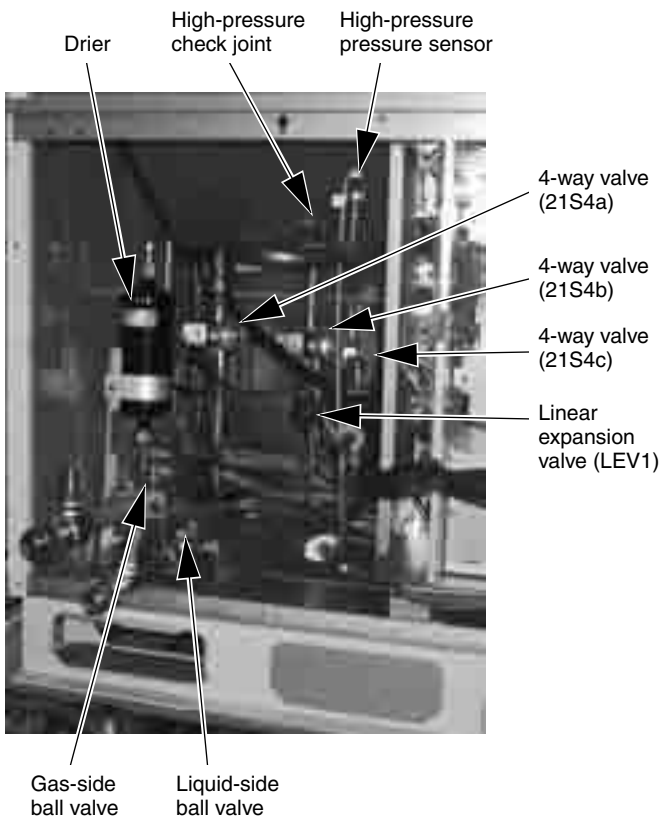

(Rear)

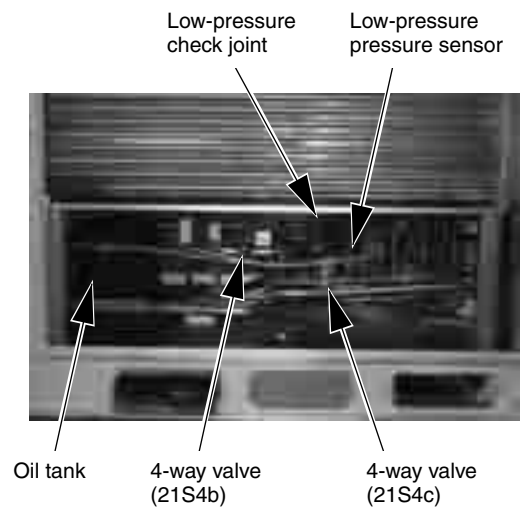

## [2] Control Box

< P200~P400-Types >

### [ Appearance ]

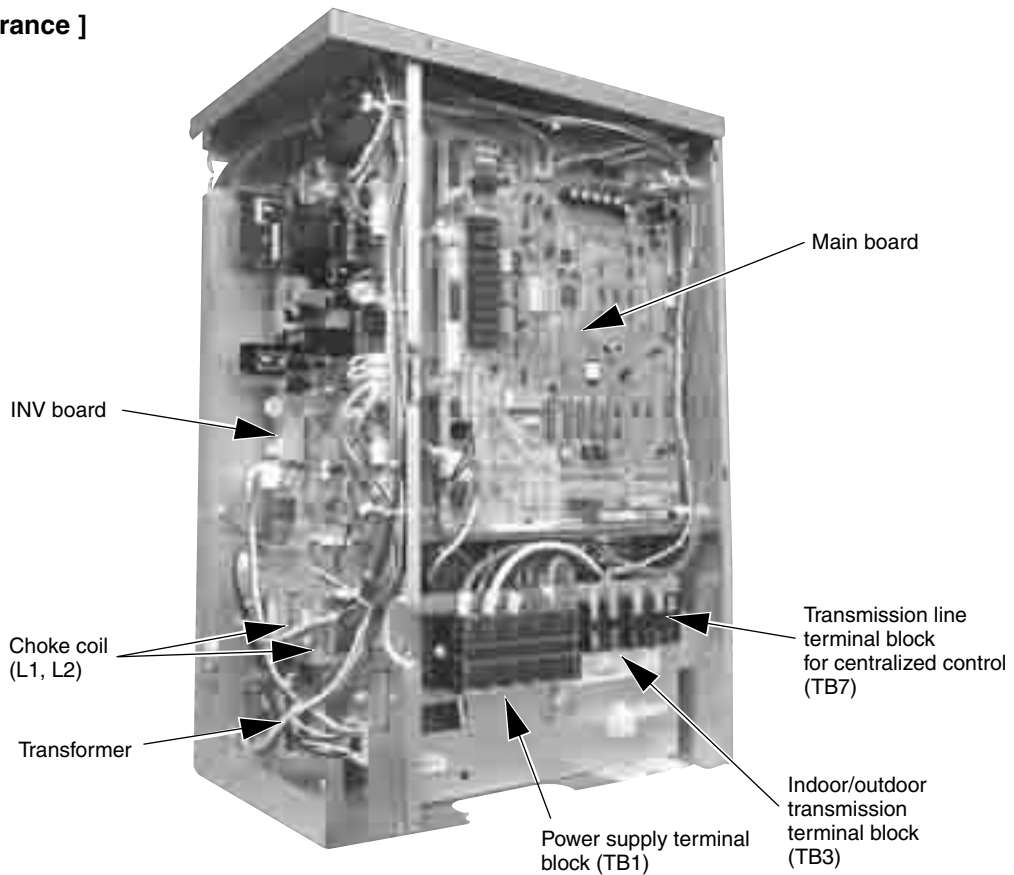

### [ Under the circuit board cover ]

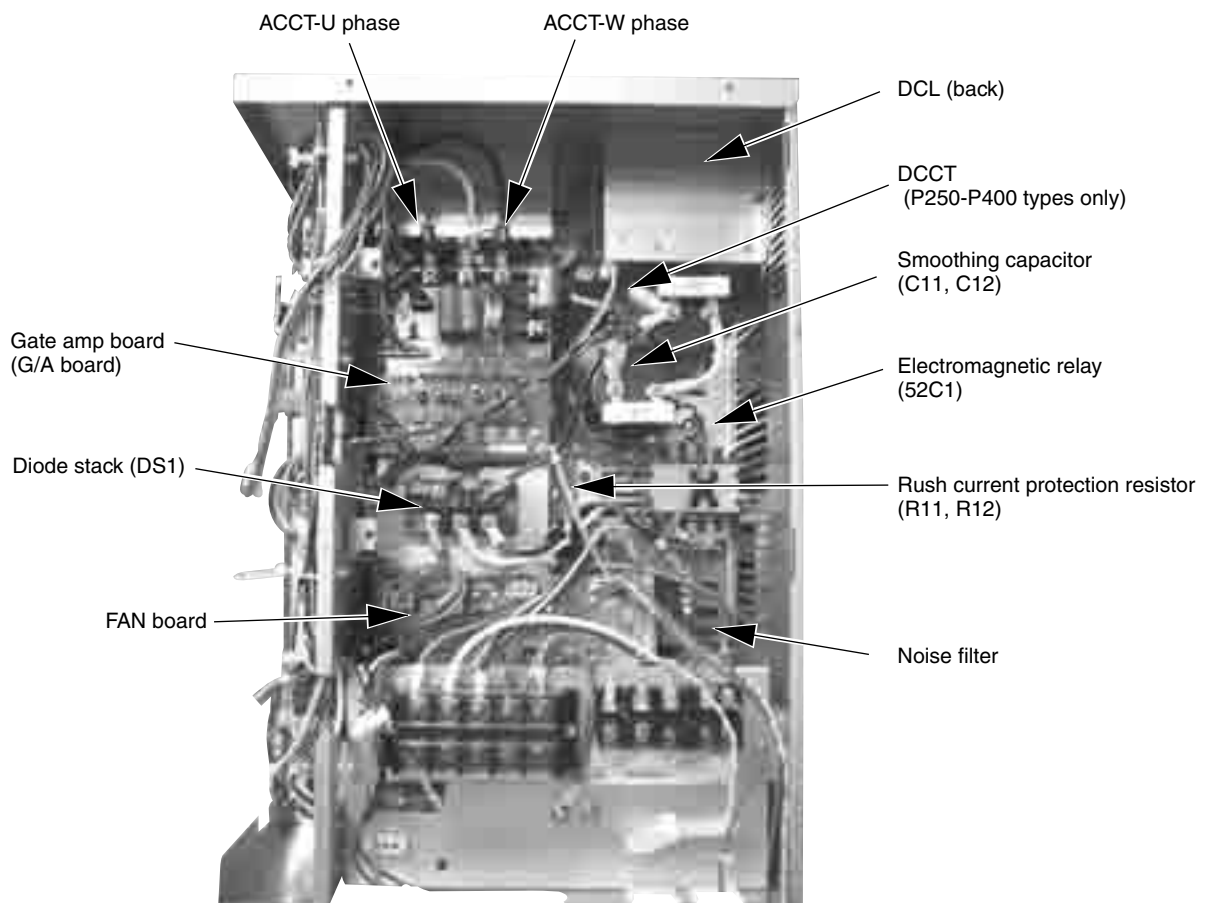

< P450~P650-Types >

[ Appearance ]

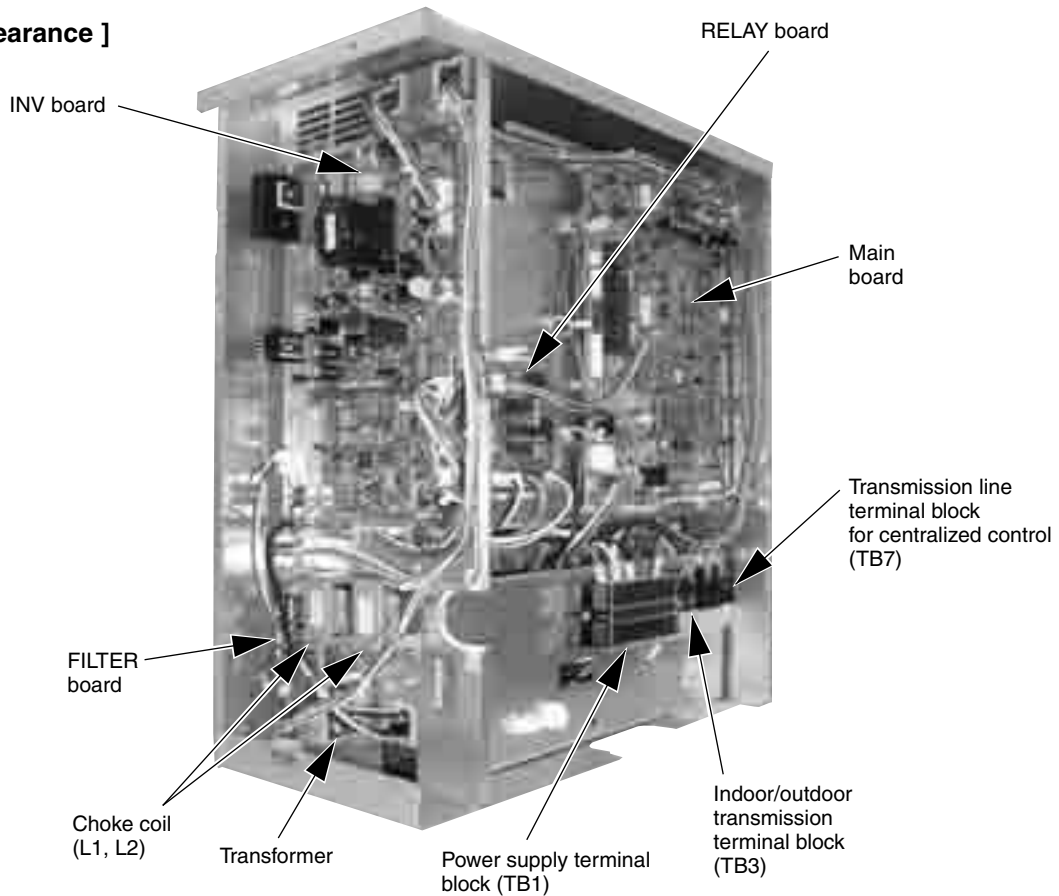

[ Under the circuit board cover ]

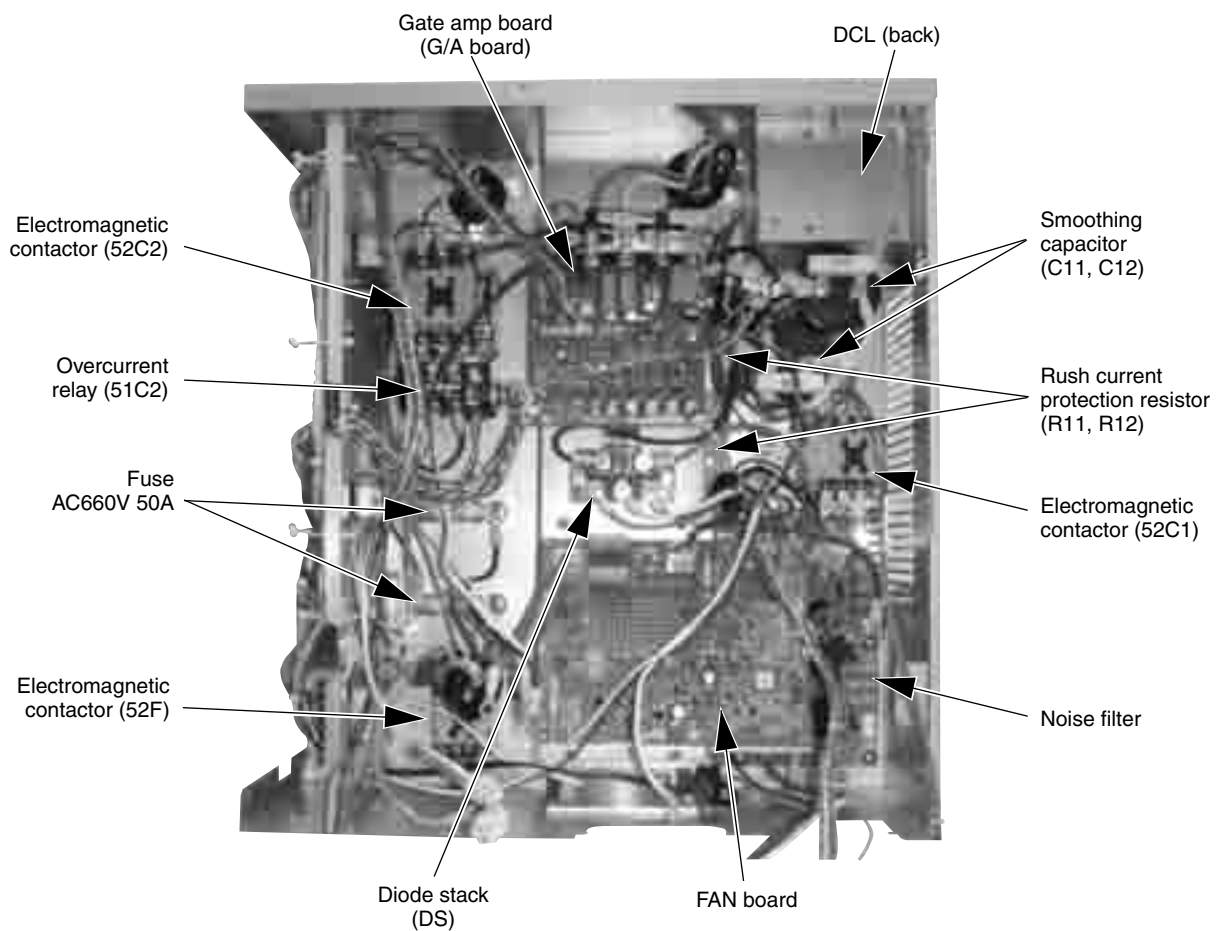

### [3] Circuit Board

#### 1. Main board

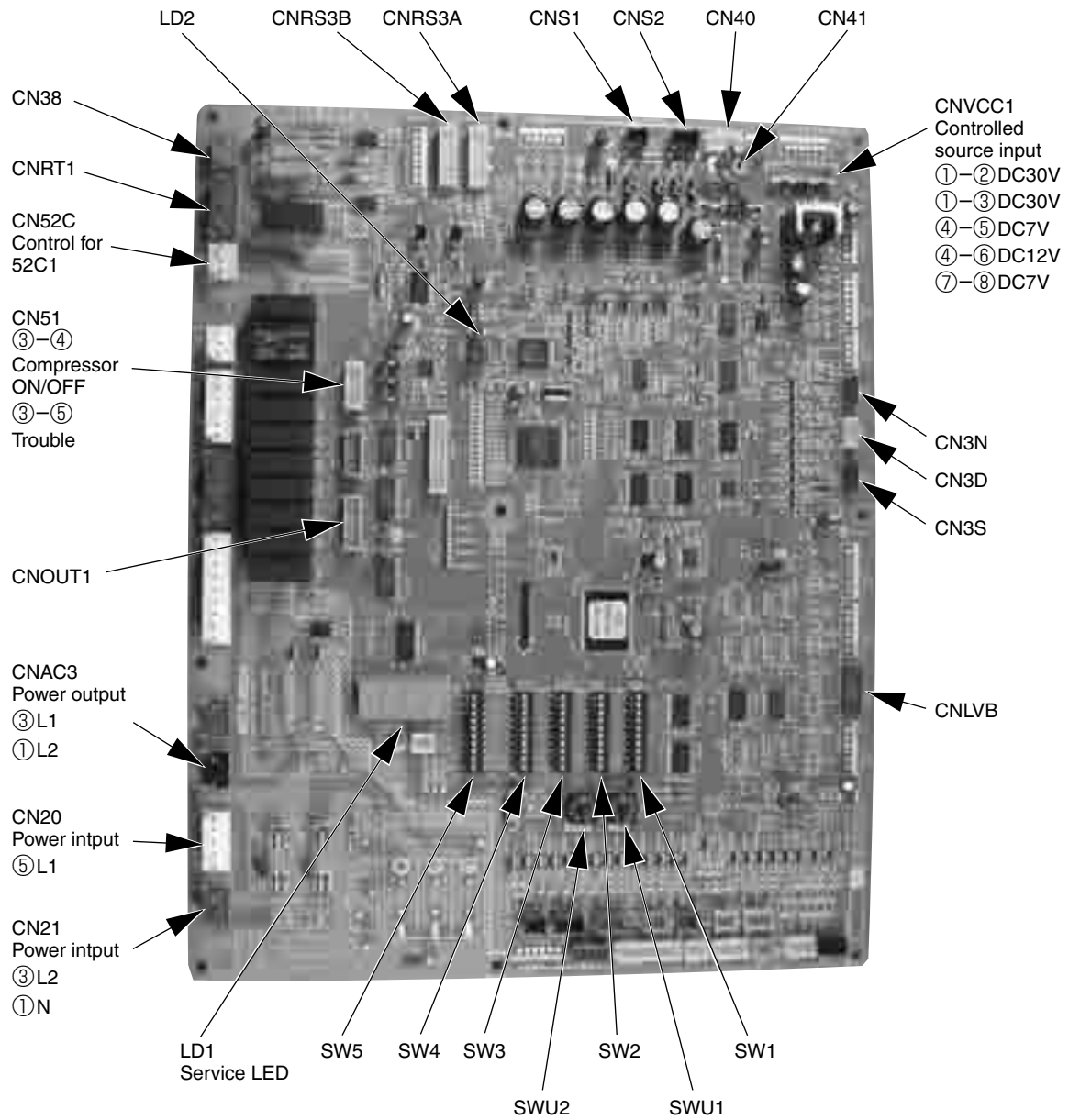

2. INV board

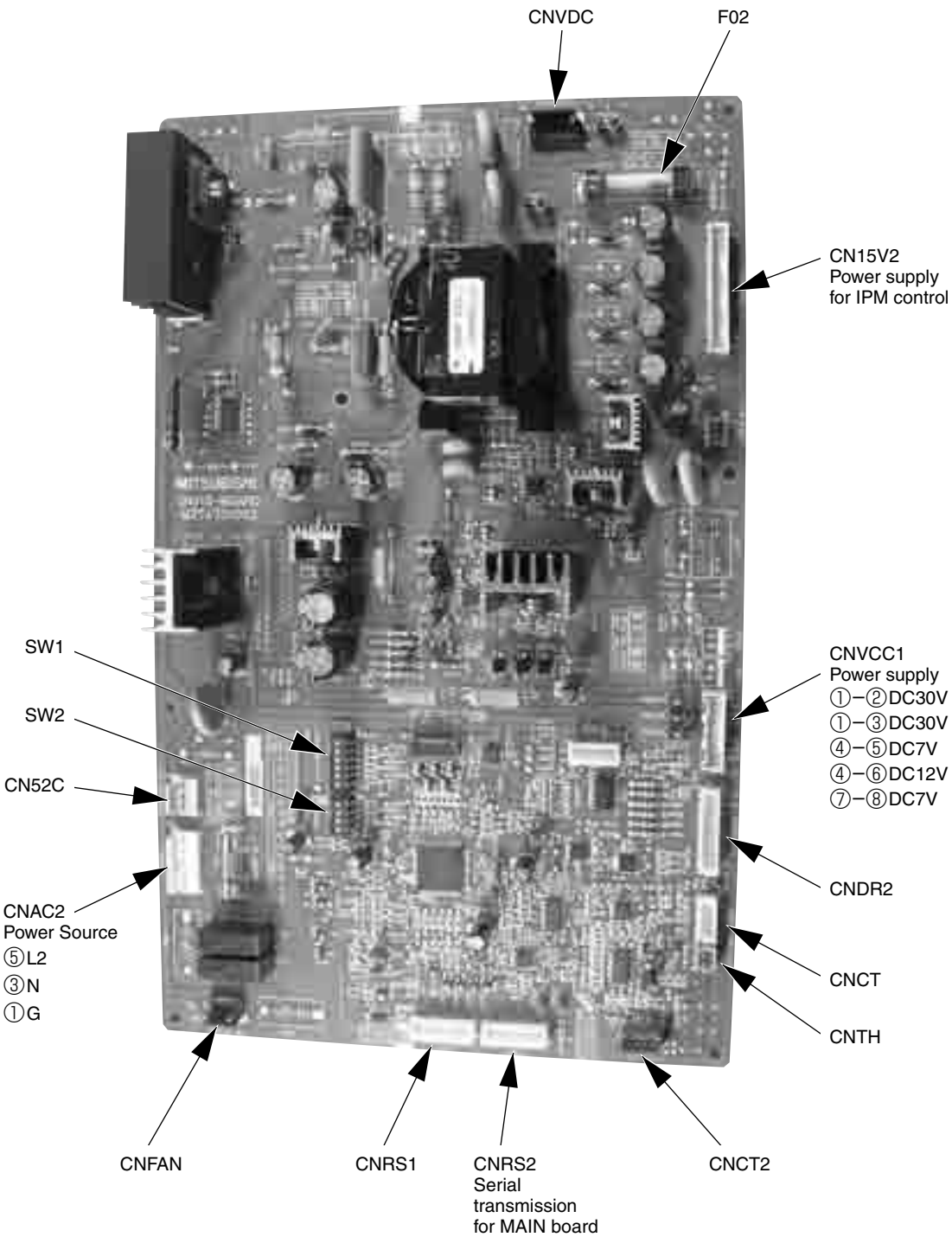



### 3. FAN board

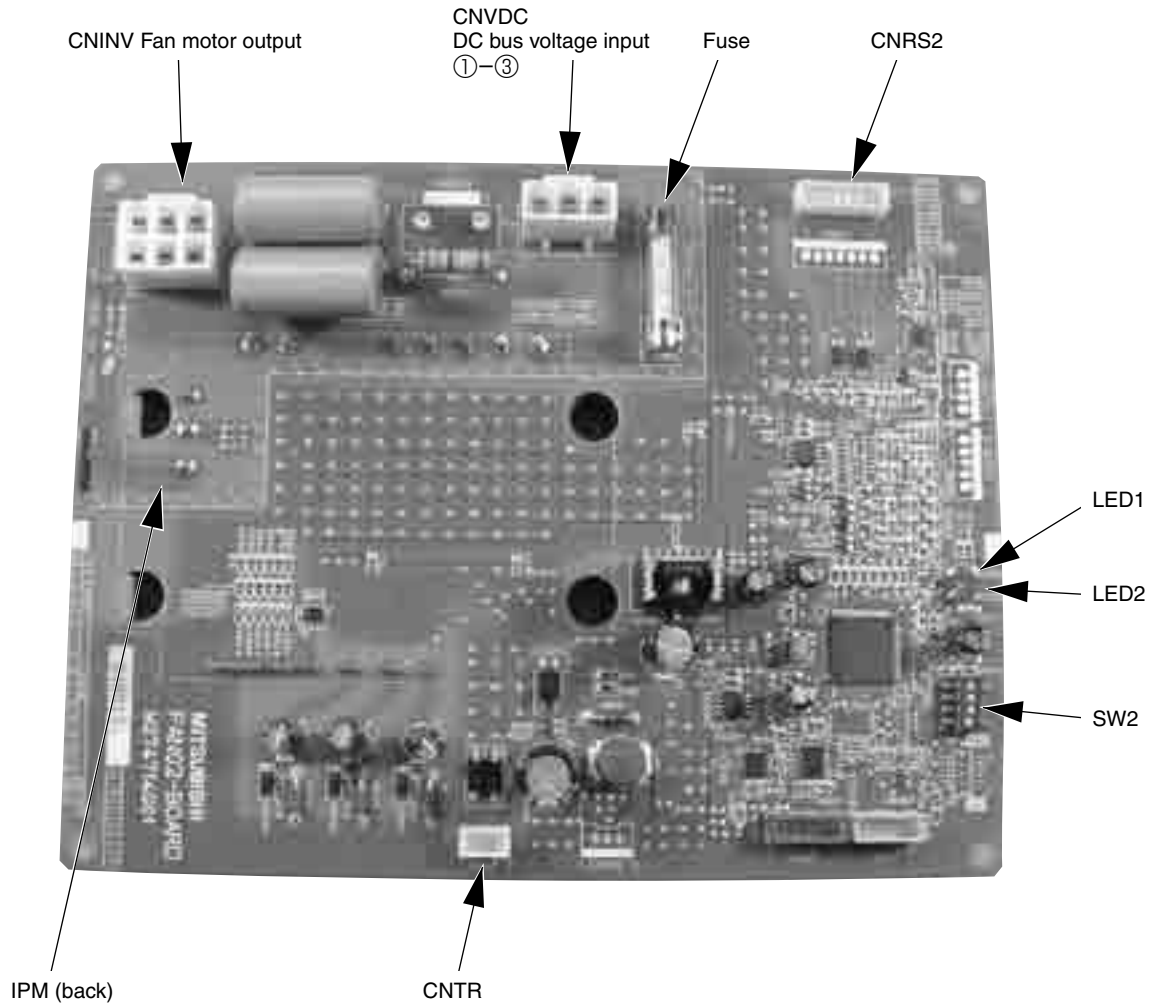

### 4. Relay board

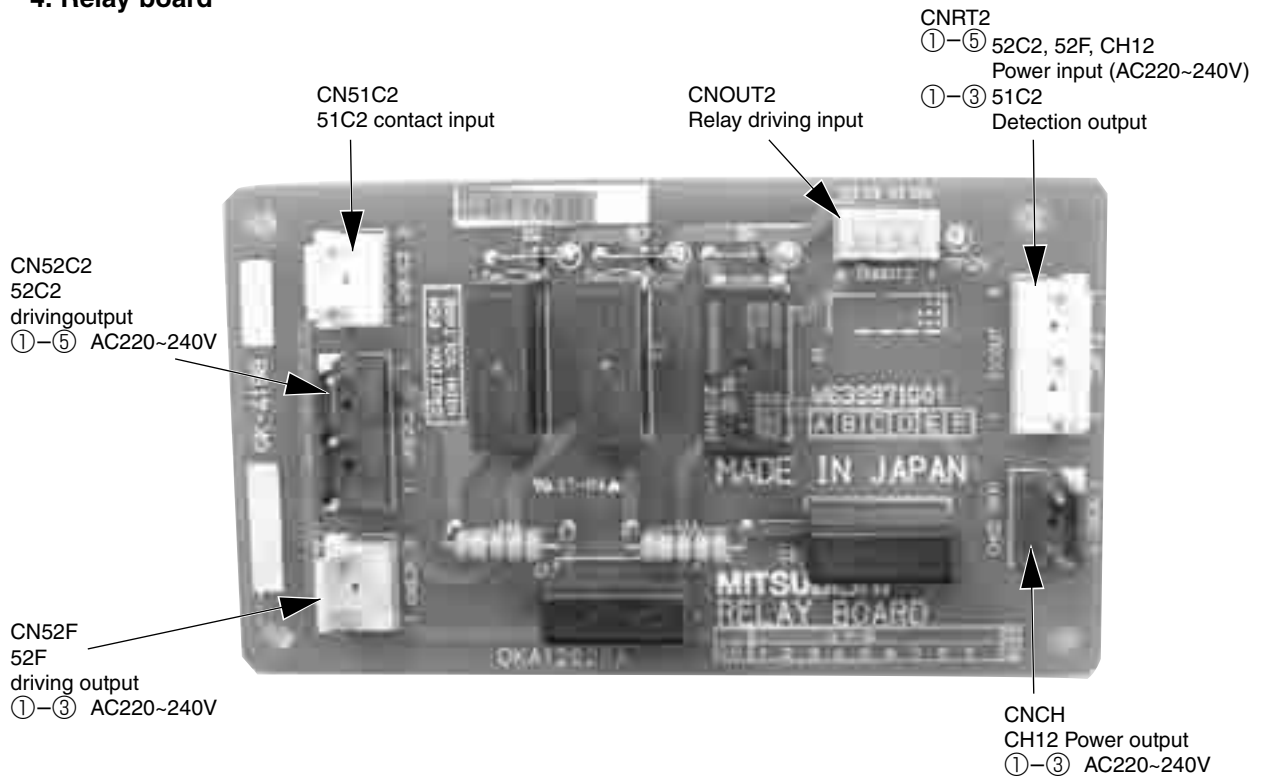

5. Filter board

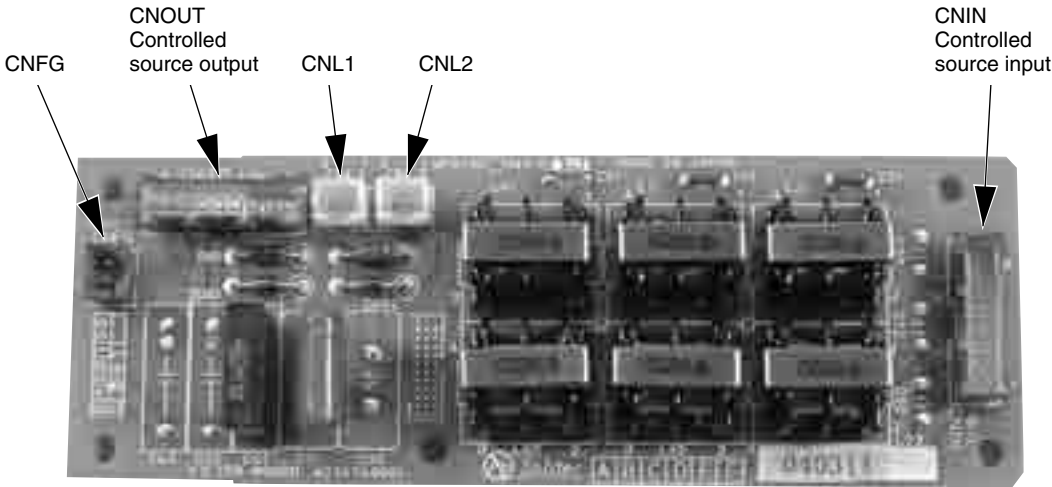

6. G/A board

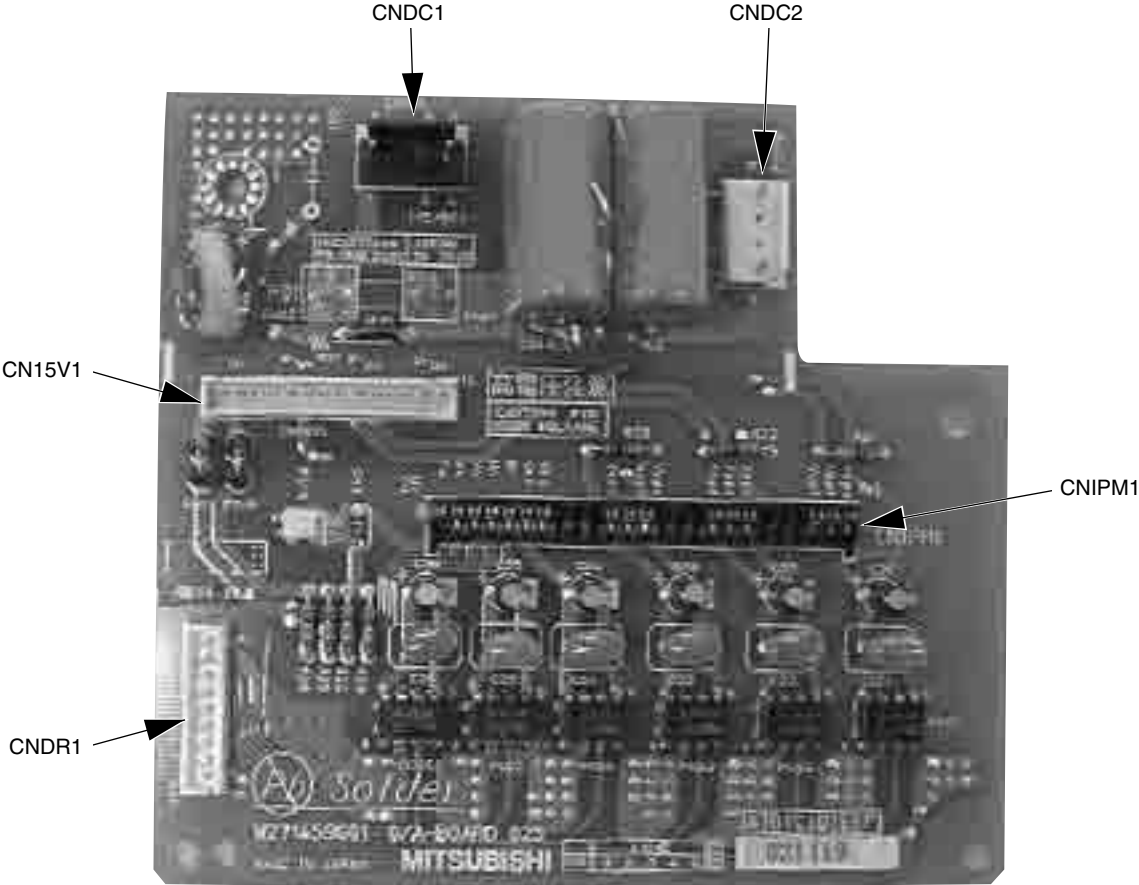

## 4 Remote Controller

### [1] Functions and Specifications of MA and ME Remote Controllers

There are two types of remote controllers: M-NET (ME) remote controller, which is connected on the indoor/outdoor transmission line, and MA remote controller, which is connected to each indoor unit.

#### 1. Comparison of Functions and Specifications of MA and ME Remote Controllers

Function/specification	MA remote controller (Notes 1, 4)	M-NET(ME)Remote Controller (Notes 2, 4)
Remote controller address setting	Not required	Required
Indoor/outdoor unit address setting	Not required (applicable only in the case of single refrigerant systems)(Note 3)	Required
Wiring method	Non-polar 2 wires ※ Daisy-chain the indoor units with non-polar 2 wires when running a group operation.	Non-polar 2 wires
Installation location of remote controller	Connectable to any indoor unit in the group	Connectable at any point on the indoor/outdoor transmission line
Interlocking with the ventilation unit	Each indoor unit can individually be interlocked with a ventilation unit. (Registered on the remote controller in the same group)	Each indoor unit can individually be interlocked with a ventilation unit. (Registered on the remote controller)
Making group changes	MA remote controller wires between indoor units require rewiring.	Indoor unit and remote controller addresses must be changed, or the registration information must be changed using MELANS.

(Note 1) MA remote controller includes MA remote controllers, MA compact remote controllers, and wireless remote controllers.

(Note 2) M-NET remote controller includes ME remote controllers and compact remote controllers.

(Note 3) Depending on the system configuration, even a single refrigerant system may require an address setting.

(Note 4) Either an MA remote controller or an M-NET remote controller can be connected to a group of multiple-refrigerant systems or when a system controller is connected.

#### 2. Selecting the Best Type of Remote Controller

Select either the MA remote controller or the M-NET remote controller to take full advantage of a given system.

The following information is provided as a reference for selection.

MA remote controller (Notes 1, 2)	M-NET (ME) remote controller (Notes 1, 2)
<ul style="list-style-type: none"> <li>• Low chances of system expansion and grouping changes are expected.</li> <li>• Grouping (floor plan) has been decided at the time of installation.</li> </ul>	<ul style="list-style-type: none"> <li>• High chances of centralized installation of remote controllers, system expansion, and grouping changes.</li> <li>• Grouping (floor plan) has not been decided at the time of installation.</li> <li>• Direct connection of the remote controller to the Lossnay inside the heater-humidifier.</li> </ul>

(Note 1) M-NET remote controllers and MA remote controllers cannot both be connected to the same group of indoor units.

(Note 2) A system controller must be connected to a system that has both MA remote controllers and M-NET remote controllers.

#### < A system using an MA remote controller >

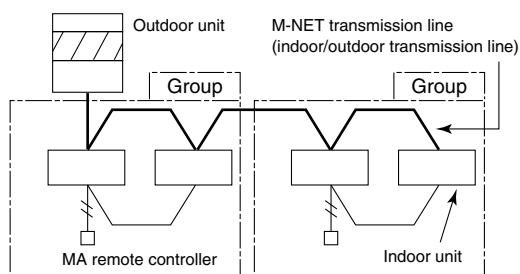

#### < System using an M-NET remote controller >

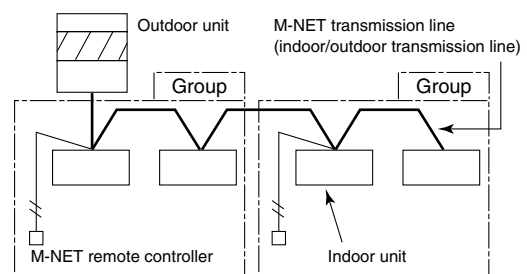

## [2] Group Setting and Interlocking Settings that are Made on the ME Remote Controller

### 1. Group setting/interlocking setting

This operation should be performed to set a group of indoor units between different refrigerant systems and to manually raise the indoor/outdoor unit addresses.

- (A) Group setting ..... To register the indoor units you want to control with the remote controller, confirm the registered units, or delete registered units.
- (B) Interlock setting ..... To register the LOSSNAY to be interlocked with indoor units, confirm the registered units, or delete registered units.

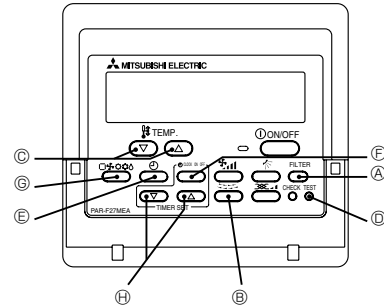

[Setting Procedure]

#### (1) Address registration

Register the indoor unit address you want to control with the remote controller.

- ① Display "H0", which flashes when the power is on, or OFF using the [ON/OFF] button.

The liquid crystal displays are shown below. If any of these displays is different, the next set cannot be performed.

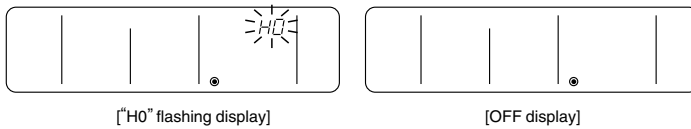

#### (A) Group registration

- ② Displaying "GROUP REGISTRATION".

- Press and hold down the (A) [FILTER] and (B) [Louver (ミニコン)] buttons at the same time for two seconds. The display shown below appears.

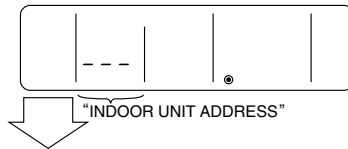

- ③ Set the unit address No.

- Press the (C) [TEMP. (▽) and (△)] buttons. The unit address No. decreases and increases. Set it to the indoor unit address No. you want to register.

- ④ Register the indoor unit address No. you have set.

- Press the (D) [TEST] button to register the indoor unit address No. being displayed.  
 - When registration is completed normally, the unit type is displayed as shown below.  
 - If the specified indoor unit does not exist, an error message will be displayed. Make sure there are indoor units and repeat the operation above.

<When registration completed normally>

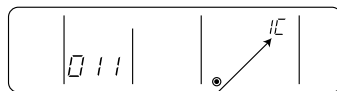

Displays the unit type. (Indoor unit in this case.)

<If an error message appears>



"BB" will flash as a registration error. (If the registered indoor unit does not exist)

- ⑤ To register multiple indoor units, repeat steps ③ and ④.

To confirm the addresses, go to "(2) Registered address confirmation".



#### (B) Interlock registration

- ⑥ Displaying "INTERLOCK REGISTRATION"

- Press the (C) [Mode selection (□, □, □, □, □, □)] button. The display shown below appears. If the button is pressed again, the display returns to ② "GROUP REGISTRATION".

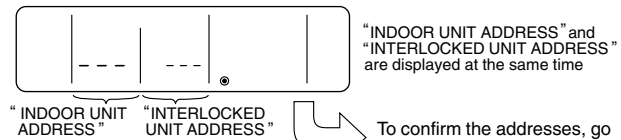

"INDOOR UNIT ADDRESS" and "INTERLOCKED UNIT ADDRESS" are displayed at the same time

To confirm the addresses, go to "(2) Registered address confirmation".

- ⑦ Displaying address No. of LOSSNAY and any indoor unit address No. you want to interlock.

- Press the (C) [TEMP. (▽) and (△)] buttons. "INDOOR UNIT ADDRESS NO." decreases and increases. Set it to the indoor unit address No. you want to interlock.  
 - Press the (H) [Time selection (▽) and (△)] buttons. "INTERLOCKED UNIT ADDRESS NO." decreases and increases. Set it to the LOSSNAY address No. you want to interlock.

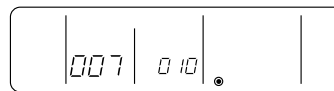

- ⑧ Register to interlock LOSSNAY with indoor unit.

- Press the (D) [TEST] button. The display shown below appears, and the indoor unit being displayed at "INDOOR UNIT ADDRESS" and the LOSSNAY being displayed at "INTERLOCKED UNIT ADDRESS" are interlocked.  
 - The above can also be registered similarly by displaying the LOSSNAY address at "INDOOR UNIT ADDRESS" and the indoor unit address at "INTERLOCKED UNIT ADDRESS".

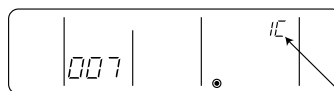

If registration is completed normally, the display alternates as shown in the figure at the left. If a registration error occurs, "BB" will flash. (Indicates that the unit does not exist.)

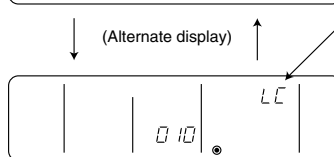

NOTE: · Interlock all the units in a group with the LOSSNAY. If not interlocked, the LOSSNAY will not operate.  
 · If an SC is connected, make an interlocking setting with the SC.



**(C) Returning to the normal state**

When all the group registration and interlock registration operations are completed, return to the normal state as described below.

- ⑩ Press and hold down the **A [FILTER]** and **B [Louver (ミニミニ)]** buttons at the same time for two seconds. The remote controller returns to the state of ①.

**(2) Registered address confirmation**

Display the indoor unit address No. registered in the remote controller by performing steps ① and ②.

**(A) Group registration information confirmation**

**⑪ Displaying "GROUP REGISTRATION"**

- Each time you press the **E [Timer selection (⊙)]** button, the registered indoor unit address No. and unit type are displayed.

<Registered>



Indicates the unit type. (Indoor unit in this case.)

<Not registered>



- When there is one registration, one address No. is displayed no matter how many times the button is pressed.
- When there are multiple registrations (ex: "011", "012", "013", the address Nos.) are displayed in 011 → 012 → 013 order each time the **E [Timer selection (⊙)]** button is pressed.

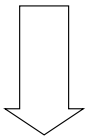

To delete an address, go to "(3) Address deletion".

To return to the normal state, go to step ⑩.

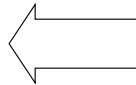

**(3) Address deletion**

Group registration information deletion deletes the indoor units registered in the remote controller.

Interlocked registration information deletion deletes the interlock between units.

Both deletion operations perform the address confirmation processing of (2) and are performed in the state in which the unit you want to delete was displayed.

**⑬ Deleting registered indoor unit or interlock between units.**

- Press the **F [Time selection (⊙ CLOCK-ON-OFF)]** button two times in succession. The displayed indoor unit address or the interlock between units is deleted.

When the information is deleted, the display shown below appears.

**⑨ Repeat steps ⑦ and ⑧ above to interlock all the indoor units in a group with the LOSSNAY.**



To return to the normal state, go to step ⑩.



To confirm the addresses, go to "(2) Registered address confirmation".

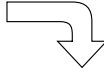

**(B) Interlocked registration information confirmation**

After performing step ⑥, proceed as follows:

**⑫ Display the indoor unit address No. you want to confirm.**

- Press the **H [Time selection (▽) and (△)]** buttons. The interlocked unit address decreases and increases. Set it to the indoor unit address No. you want to confirm.



The above can also be confirmed similarly by displaying the LOSSNAY address at the interlocked unit address.

**⑬ Displaying the LOSSNAY address No. interlocked at step ⑫.**

- Press the **E [Timer selection (⊙)]** button. The interlocked LOSSNAY address No. and indoor unit address No. are alternately displayed.



Address of unit that is interlocked

(Alternate display)



**⑭ Displaying another registered unit address No.**

- After step ⑬, press the **E [Timer selection (⊙)]** button again. Another registered unit address No. is displayed. (The display method is the same as step ⑬.)



Address of another registered unit

(Alternate display)

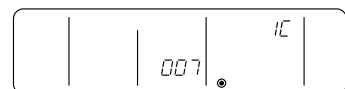

To delete an address, go to "(3) Address deletion".

**(A) Deleting group registration information**

<When completed normally>



"--" is displayed at the room temperature display.

- If there is a transmission error, registration is not deleted and the display shown below appears.

<When an error occurs>

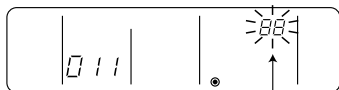

"BB" is displayed at the room temperature display.

To return to the normal state, go to step ⑩.

**(B) When deleting interlocked registration**

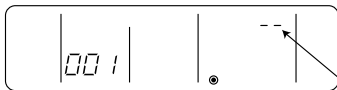

(Alternate display)

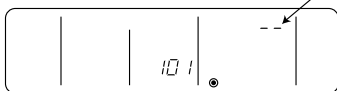

When deletion was completed normally, "--" is displayed at the unit type display. If a deletion error occurred, "BB" is displayed at the unit type display. In this case, repeat the operations described above.

**(4) (A) Group registration and (B) Interlock registration of another group using an arbitrary remote controller**

(A) Group registration and (B) Interlock registration of another group can be performed using an arbitrary remote controller. For a description of the operation procedure, see "(B) Interlock registration" of section [2] 1. Group setting/interlocking setting. Set the address No. as shown below.

**(A) When performing group registration**

Interlocked unit address ... Remote controller address No.  
Indoor unit address ..... Indoor unit address No. you want to control with the remote controller

**(B) When performing interlock registration**

Interlocked unit address ... LOSSNAY address No.  
Indoor unit address ..... Indoor unit address No. which is interlocked with LOSSNAY

**2. Remote controller functions selection**

In the remote controller function selection mode, three functions can be selected and changed. Select and change these functions, as required. For the operating instructions refer to "(6) How to select the remote controller functions" of (3 | How to Operate) in Instruction Book.

**(A) Operation mode display selection mode ("AUTO" mode heating/cooling display selection)**

When the "AUTO" mode was selected with the remote controller, the indoor unit is judged from the room temperature and heating or cooling is performed automatically. In this case, "AUTO" "COOLING" or "AUTO" "HEATING" is displayed at the remote controller. However, only "AUTO" without "COOLING" or "HEATING" can also be displayed.

**(B) Room temperature display selection mode (Room temperature display/no display selection)**

Normally, the intake air temperature is displayed at the remote controller. However, no display can also be selected.

**(C) Set temperature range limit mode**

Ordinarily, the set temperature can be freely set over the 19°C to 30°C range for cooling and dry and the 17°C to 28°C range for heating. However, for cooling and dry, the lower limit temperature and for heating, the upper limit temperature can be limited to a preset temperature. If the set temperature range is made higher for cooling and dry and is set lower for heating by this method, excessive cooling and heating can be prevented and energy can be saved.

	<p><b>CAUTION</b> When the normal set temperature adjustment range was changed using a remote controller connected to a simultaneous cooling/heating air condition with an AUTO mode, the AUTO mode cannot be selected with the [Mode selection] button.</p>
--	--

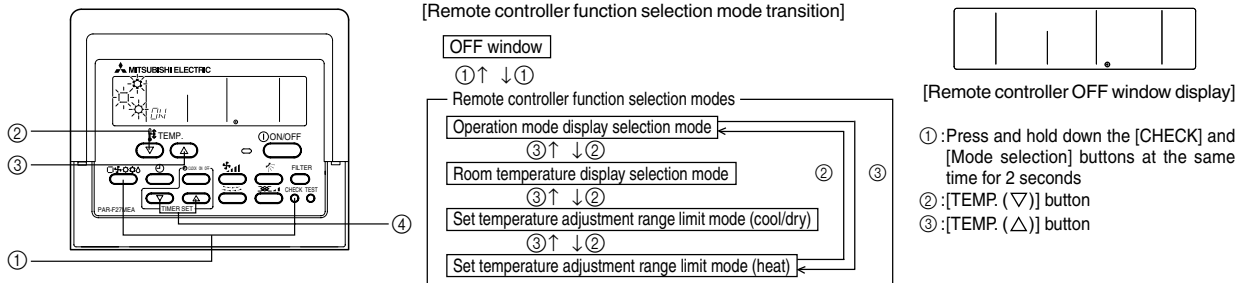

**[PROCEDURE]**

1. Set the air conditioner to the off state with the remote controller [ON/OFF] button. The remote controller display shifts to the OFF window display shown at the left.
2. When the [CHECK] and [Mode selection] buttons ① are pressed and held down at the same time for two seconds, the remote controller switches to the remote controller function selection mode and the "OPERATION MODE DISPLAY SELECTION MODE" window appears. The other three modes can be selected by operating the [TEMP.] (▽) button ② or (△) button ③. Display the mode whose function you want to change.

**OPERATION MODE DISPLAY SELECTION MODE (When you want to change the AUTO mode display)**

- "AUTO" "COOL/HEAT" flashes and "ON" or "OFF" lights. Each time the [Time selection (△) or (▽)] button ④ is pressed in this state, the "ON" and "OFF" display is switched.

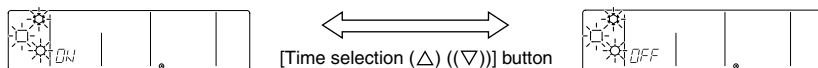

- When "ON" was selected, "AUTO" "COOL" or "AUTO" "HEAT" is displayed during AUTO mode operation.
- When "OFF" was selected, only "AUTO" is displayed during AUTO mode operation.

**ROOM TEMPERATURE DISPLAY SELECTION MODE (When you want to change room temperature display/no display)**

- "88 °C" flashes at the room temperature display and "ON" or "OFF" lights. Each time the [Time selection (△) or (▽)] button ④ is pressed in this state, the "ON" and "OFF" display is switched.

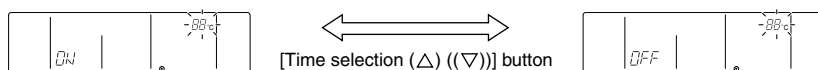

- When "ON" was selected, the room temperature is continuously displayed in the ON window.
- When "OFF" was selected, the room temperature is not displayed in the ON window.

**SET TEMPERATURE RANGE LIMIT MODE (When you want to change the set temperature adjustment range)**

1) Cool/dry mode temperature selection

"COOL/DRY" and "LIMIT TEMP" light on the display and the set temperature adjustment range in the cool (dry) mode is displayed. The lower limit temperature of the set temperature display flashes. This temperature value can be set and changed.

[Lower limit temperature adjustment range]: 19 °C ↔ 30 °C (Upper limit temperature 30°C is fixed. Only the lower limit temperature can be changed.)



[When set temperature adjustment range in cool/dry mode is 19 °C to 30 °C]

- 2) Each time the [Time selection (△) or (▽)] button ④ is pressed, the lower limit temperature value is increased or decreased. Set it to the desired set temperature adjustment range.

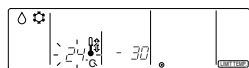

[When set temperature adjustment range was set to 24 °C to 30 °C]

- 3) When the [TEMP. (▽)] button ② is pressed after the setting above, the remote controller switches to the heat mode temperature selection window. "HEAT" and "LIMIT TEMP" light on the display and the heat mode set temperature adjustment range is displayed.

The upper limit temperature value can be changed by pressing the [Time selection (△) or (▽)] button ③, the same as cool/dry mode temperature selection.

Upper limit temperature adjustment range: 17 °C to 28 °C (The lower limit temperature 17°C is fixed. Only the upper limit temperature can be changed.)

3. At the end of selection of each function, release the remote controller function selection mode and display the OFF window by pressing the [CHECK] and [Mode selection] buttons ① at the same time for two seconds.

**[3] Interlocking Setting that is Made on the MA Remote Controller**

**Lossnay interlocking setting**

Make this setting only when interlocked operation with LOSSNAY is necessary with CITY MULTI models.)

(This setting cannot be made with Mr. SLIM air conditioners.)

Perform this operation when you want to register the LOSSNAY, confirm the registered units, or delete the registered units controlled by the remote controller.

The following uses indoor unit address 05 and LOSSNAY address 30 as an example to describe the setting procedure.

**[Setting Procedure]**

- ① Stop the air conditioner using the remote controller ① [ON/OFF] button. If the OFF display shown below does not appear at this time, step ② cannot be performed.



- ② Press and hold down the ② [FILTER] and ③ [Louver] buttons at the same time for two seconds. The display shown below appears. The remote controller confirms the registered LOSSNAY addresses of the currently connected indoor units.

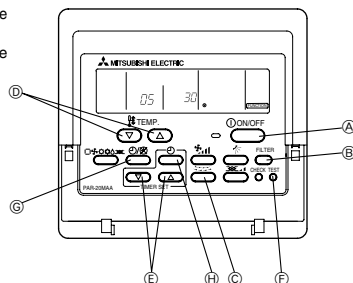
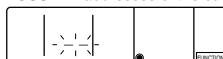

- ③ Registration confirmation result  
- The indoor unit address and registered LOSSNAY address are displayed alternately.

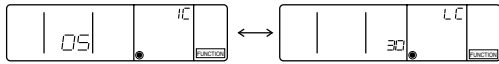

<Indoor unit address and indoor unit display> <LOSSNAY address display and LOSSNAY display>

- When LOSSNAY are not registered



- ④ If registration is unnecessary, end registration by pressing and holding down the [FILTER] and [Louver] buttons at the same time for two seconds.

If a new LOSSNAY must be registered, go to step 1. **Registration procedure**. If you want to confirm another LOSSNAY, go to step 2. **Confirmation procedure**. To delete a registered LOSSNAY, go to step 3. **Deletion procedure**.

< 1. Registration procedure >

Set the address of the LOSSNAY and the indoor unit connected by the remote controller you want to register using the [TEMP.] (▽) and (△) buttons. (01 to 50)

Set the address of the LOSSNAY you want to register using the [TIMER SET] (▽) and (△) buttons. (01 to 50)



Indoor unit address      LOSSNAY address

Press the [TEST] button, and register the set indoor unit address and LOSSNAY address.

- Registration end display

The indoor unit address and "IC" and LOSSNAY address and "LC" are alternately displayed.

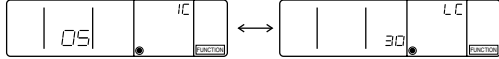

- Registration error display

If the address was not correctly registered, the indoor unit address and registered LOSSNAY address are alternately displayed.



Cannot be registered because the registered indoor unit or LOSSNAY does not exist.

Cannot be registered because another LOSSNAY was registered at the registered indoor unit.

< 2. Confirmation procedure >

Set the address of the indoor unit connected by the remote controller whose LOSSNAY you want to confirm using the [TEMP.] (▽) and (△) buttons. (01 to 50)



<Indoor unit address>

Press the [Timer selection] button and confirm the LOSSNAY address registered at the set indoor unit address.

- Confirmation end display (When LOSSNAY is connected.)

The indoor unit address and "IC" and registered LOSSNAY address and "LC" are alternately displayed.



- Confirmation end display (When LOSSNAY is not connected.)

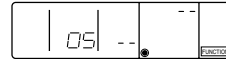

Registered indoor unit address does not exist.



< 3. Deletion procedure >

Use this procedure when you want to delete registration of indoor units connected by the remote controller and LOSSNAY.

- ⑩ Confirm (see 2. **Confirmation procedure**) the LOSSNAY you want to delete and display the indoor units and LOSSNAY confirmation results.



- ⑪ Press the [TIMER SET] button twice and delete registration of the LOSSNAY registered at the set indoor unit.

- Deletion end display

Indoor unit address and "--" and registered LOSSNAY address and "--" are alternately displayed.



- Deletion error display

When deletion was not performed properly.



## [4] Switching to the built-in Thermo on the remote controller

### 1. Selecting the position of temperature detection by the indoor unit (Factory setting: SW1-1 "OFF")

To use the built-in sensor in the remote controller, set the SW1-1 on the indoor unit to ON.

\* Some remote controllers are not equipped with a built-in sensor. Use the built-in sensor on the indoor unit instead.

\* When using the built-in sensor on the remote controller, install the remote controller where room temperature can be detected.



# 5 Electrical Wiring Diagram

## [1] PUHY-P200, P250, P300, P350, P400YGM-A / PUY-P200, P250, P300, P350YGM-A

< Symbol explanation >

Symbol	Name
ACCT1	AC Current Sensor
DOCT1	DC Current Sensor
DCL	DC reactor (Power factor improvement)
DCL1	Magnetic contactor (Inverter main circuit)
MF1	Fan motor (Radiator panel)
CH11	Crank case heater (Compressor)
21S4a ~#5	4-way valve
21S4b ~#4	
SV1	Solenoid valve (Discharge-suction bypass)
SV5b	Solenoid valve (Heat exchanger capacity control)
SV5c ~#4	Electronic expansion valve (SC coil)
LEV1	Discharge pipe temp. detect
TH1	Pipe temp. detect (Hex outlet)
TH6	OA temp. detect
TH7	liquid outlet temp. detect at Sub-cool coil
TH8	bypass outlet temp. detect at Sub-cool coil
THH1	Radiator panel temp. detect
69H1	High pressure switch
69HS	High pressure sensor
69LS	Low pressure sensor
L1.L2	Choke coil (Transmission)
Z20	Function device
⊕	Earth terminal

< Difference of appliance >

Model name	Appliance
PUHY-P200YGM-A	"#3" and "#4" do not exist.
PUHY-P250/P300/P350YGM-A	"#4" do not exist.
PUHY-P400YGM-A	All exists
PUY-P200YGM-A	"#2", "#3", "#4" and "#5" do not exist.
PUY-P250/P300/P350YGM-A	"#2", "#4" and "#5" do not exist.

\*1: Function according to switch operation.  
(SW4-7, CN3D 1-2P and CN3D 1-3P)

SW4-7:OFF  
(Compressor ON/OFF and NIGHT MODE)

CN3D	Compressor	CN3D	NIGHT MODE
1-3P	ON/OFF	1-2P	ON
OPEN	ON	OPEN	OFF
SHORT	OFF	SHORT	ON

SW4-7:ON (STEP DEMAND)

CN3D 1-2P	CN3D 1-3P
OPEN	SHORT
100%	75%
SHORT	50%

\*2: Auto changeover (CN3N 1-2P, 1-3P)

CN3N 1-3P	CN3N 1-2P
OPEN	SHORT
Auto changeover:OFF	-
SHORT	Auto changeover:ON
	COOL
	HEAT

NOTE: The broken lines indicate field wiring.

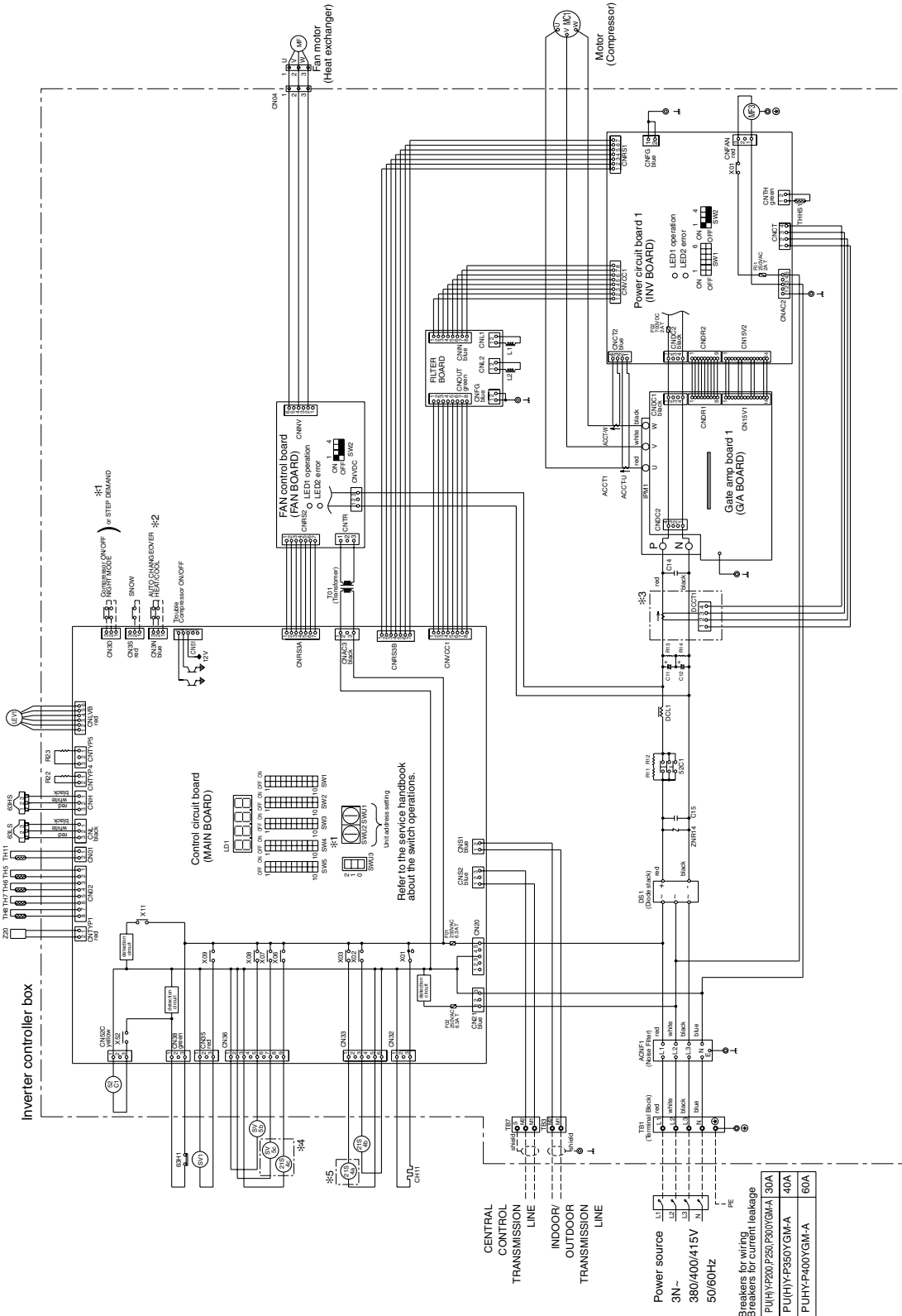

## [2] PUHY-P450, P500, P550, P600, P650YGM-A

< Symbol explanation >

Symbol	Name
ACCT1	AC Current Sensor
DCCT1	DC Current Sensor
DCL1	DC reactor (Power factor improvement)
52C1	Magnetic contactor (Inverter main circuit)
52C2	Magnetic contactor (No.2 Compressor)
51C2	Overload relay (No.2 Compressor)
52F	Magnetic contactor (Fan motor)
MF3	Fan motor (Radiator panel)
CH11,12	Crank case heater (Compressor)
21S4a,b,c	4-way valve
SV1,3	Solenoid valve (Discharge-suction bypass)
SV5b,c	Solenoid valve (Heat exchanger capacity control)
LEV1	Electronic expansion valve (SC coil)
TH11,12	Discharge pipe temp. detect
TH5	Pipe temp. detect (Hex outlet)
TH6	OA temp. detect
TH7	liquid outlet temp. detect at Sub-cool coil
TH8	bypass outlet temp. detect at Sub-cool coil
THH1,2	Radiator panel temp. detect
63H1,2	High pressure sensor
63LS	Low pressure sensor
L1,L2	Choke coil (Transmission)
Z20	Function device
⊕	Earth terminal

\*1: Function according to switch operation.  
(SW4-7,CN3D 1-2P and CN3D 1-3P)  
SW4-7: OFF (Compressor ON/OFF and NIGHT MODE)

CN3D 1-3P	Compressor ON/OFF	CN3D NIGHT MODE
OPEN	ON	OFF
SHORT	OFF	ON

SW4-7: ON (STEP DEMAND)

CN3D 1-2P	CN3D 1-3P	CN3N 1-2P	CN3N 1-3P
OPEN	OPEN	OPEN	OPEN
SHORT	SHORT	SHORT	SHORT
75%	100%	CN3N 1-2P	CN3N 1-3P
50%	0%	Auto changeover-OFF	Auto changeover-ON
		COOL	HEAT

\*2: Auto changeover (CN3N 1-2P:1-3P)

CN3N 1-2P	CN3N 1-3P
OPEN	OPEN
SHORT	SHORT
COOL	HEAT

NOTE: The broken lines indicate field wiring.

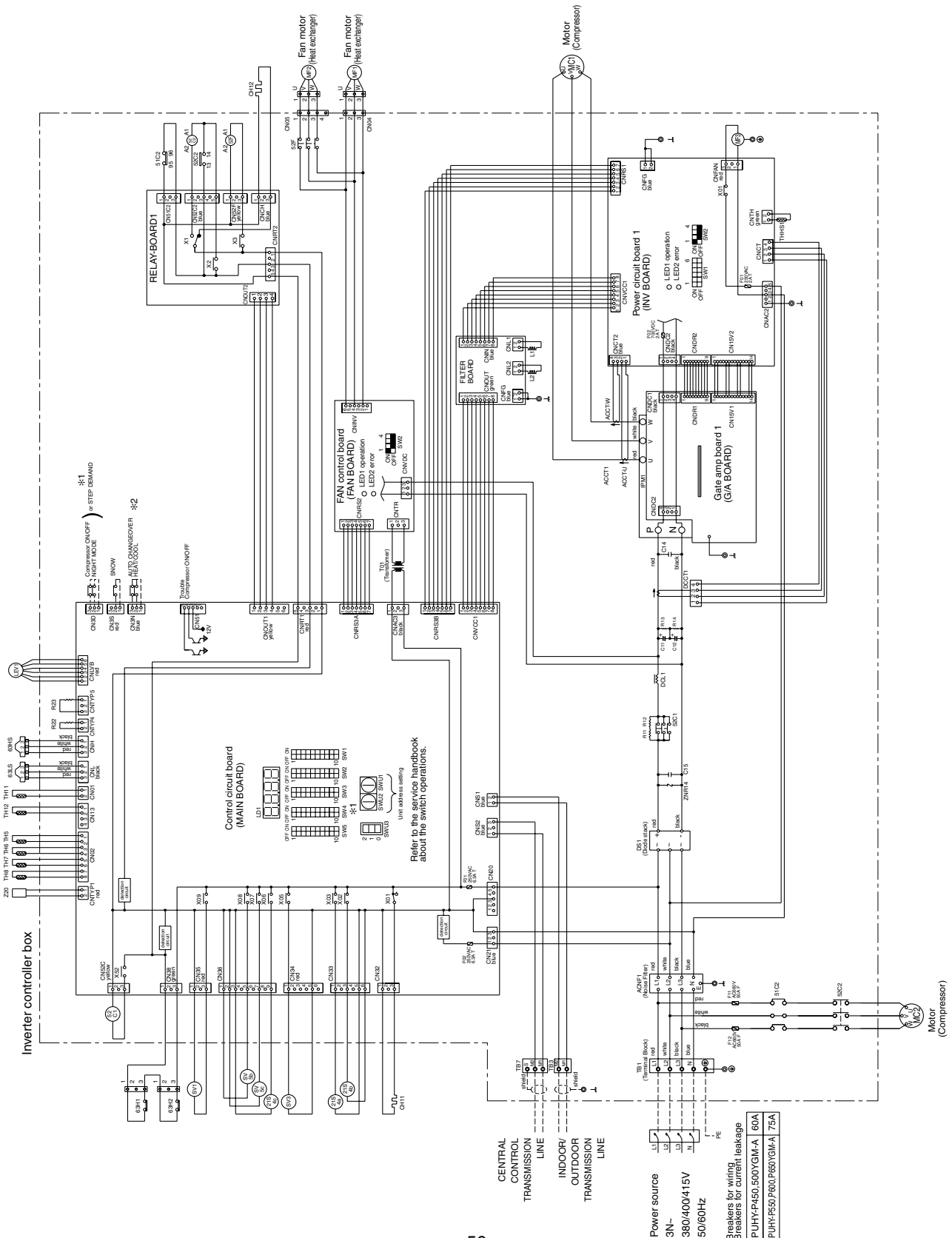

### [3] Power Dispatching Extension Unit for the Transmission Lines

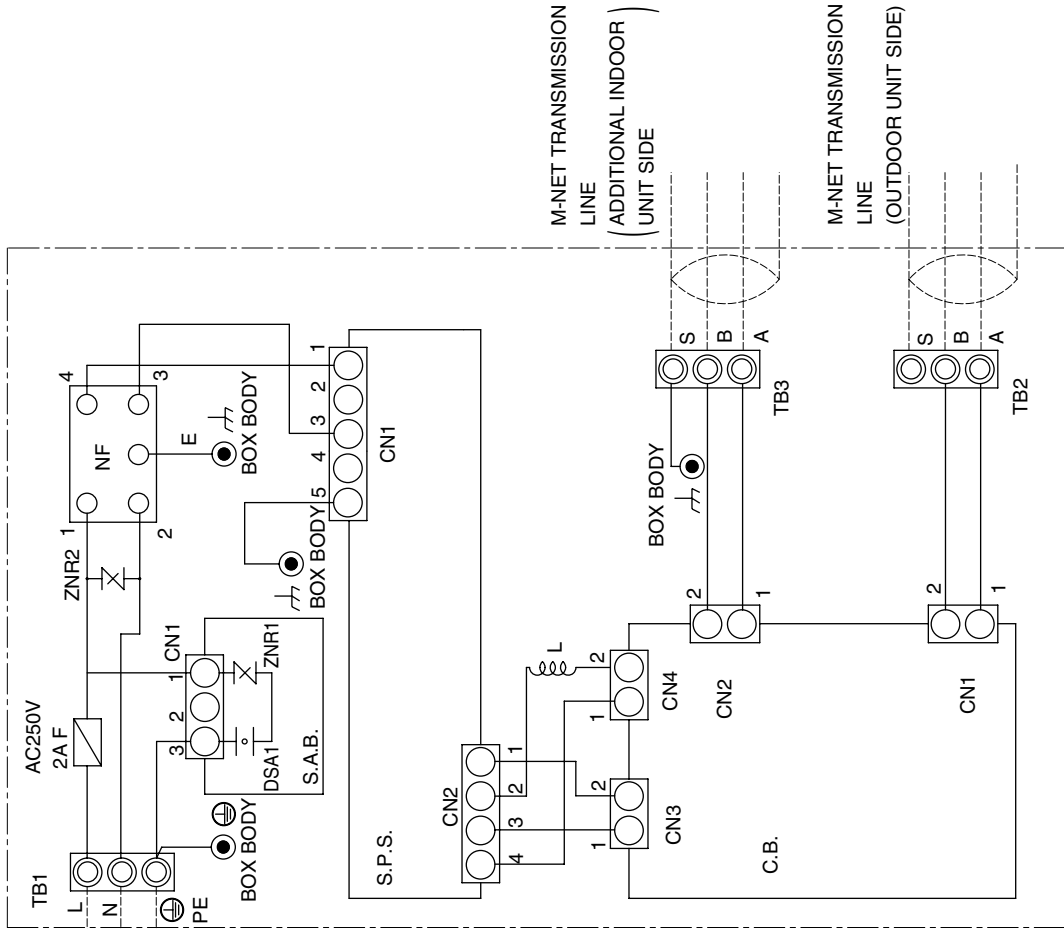

Breaker (3A)

Power source  
220-240V~N  
50/60Hz

#### SYMBOL EXPLANATION

SYMBOL	NAME
C.B.	Circuit board
S.P.S.	Switching Power Supply
S.A.B.	Surge absorber board
NF	Noise Filter
L	Choke coil(Transmission)
DSA1	Surge Absorber
ZNR1,2	Varistor
F	Fuse
TB1	Power source
TB2	M-NET transmission line (Outdoor unit side)
TB3	M-NET transmission line (Additional indoor unit side)
⊕	Earth terminal

## 6 Refrigerant Circuit

### [1] Refrigerant Circuit Diagram

< PUHY-P200, P250, P300, P350YGM-A >

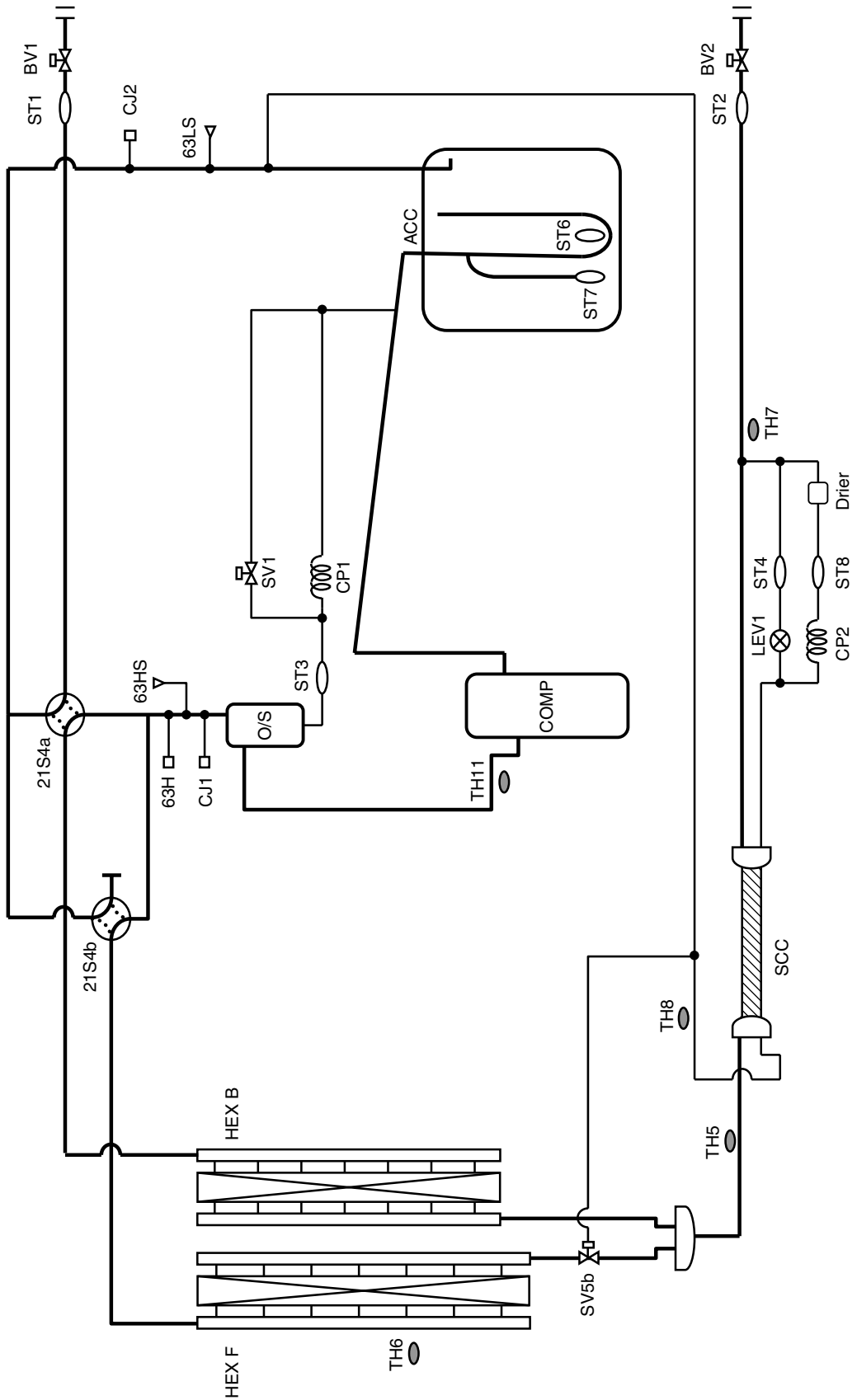

< PUY-P200, P250, P300, P350YGM-A >

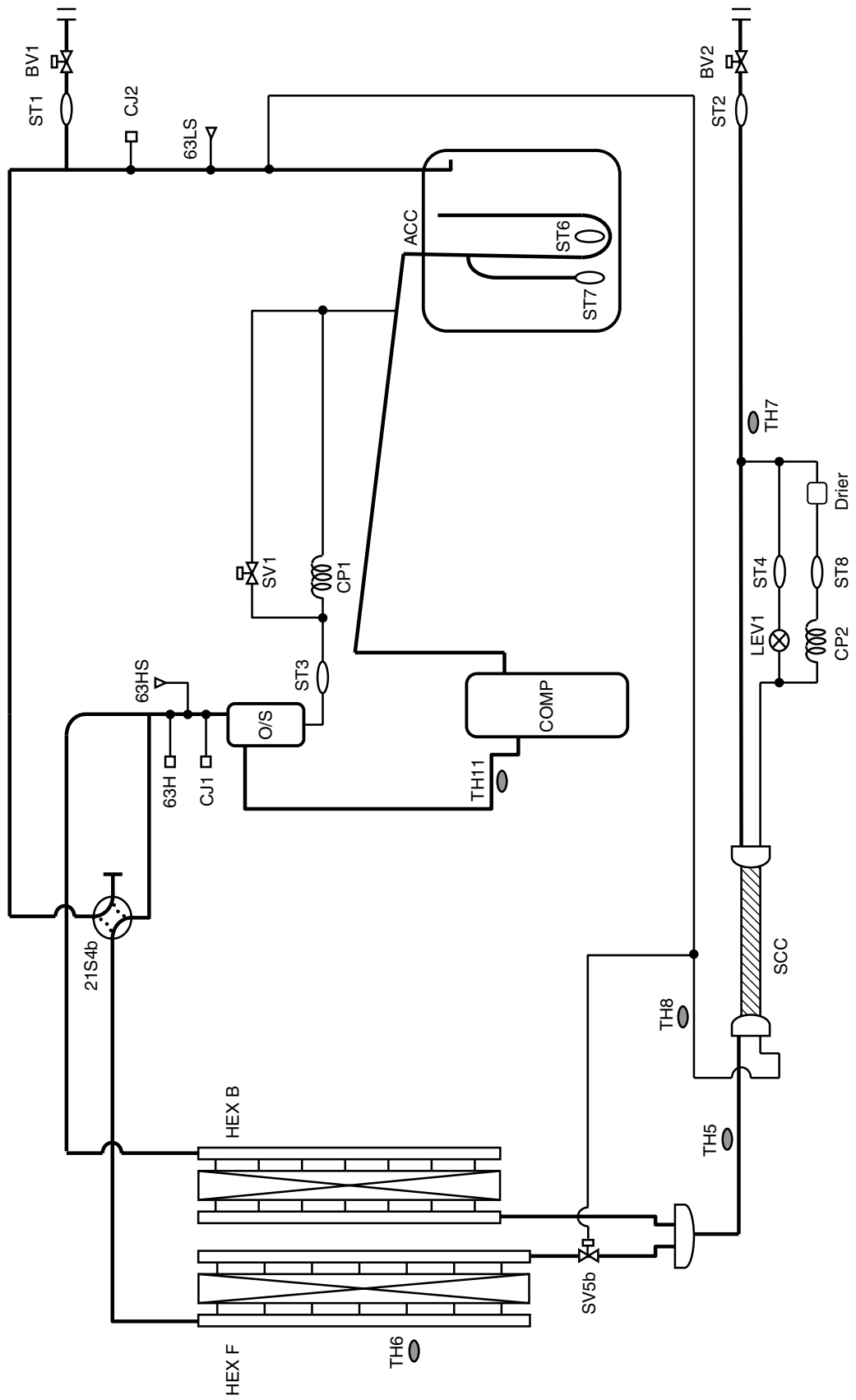

< PUHY-P400YGM-A >

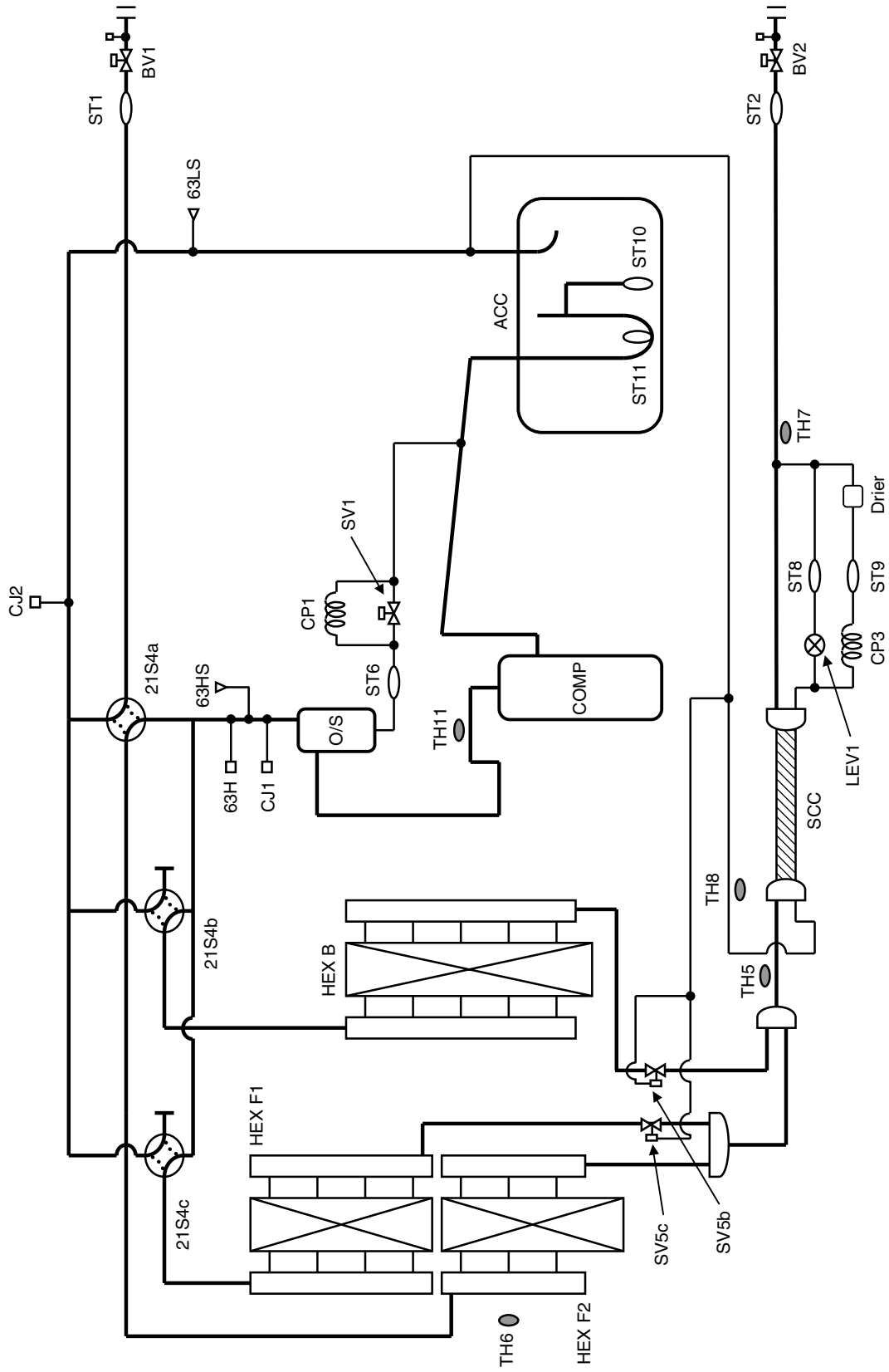

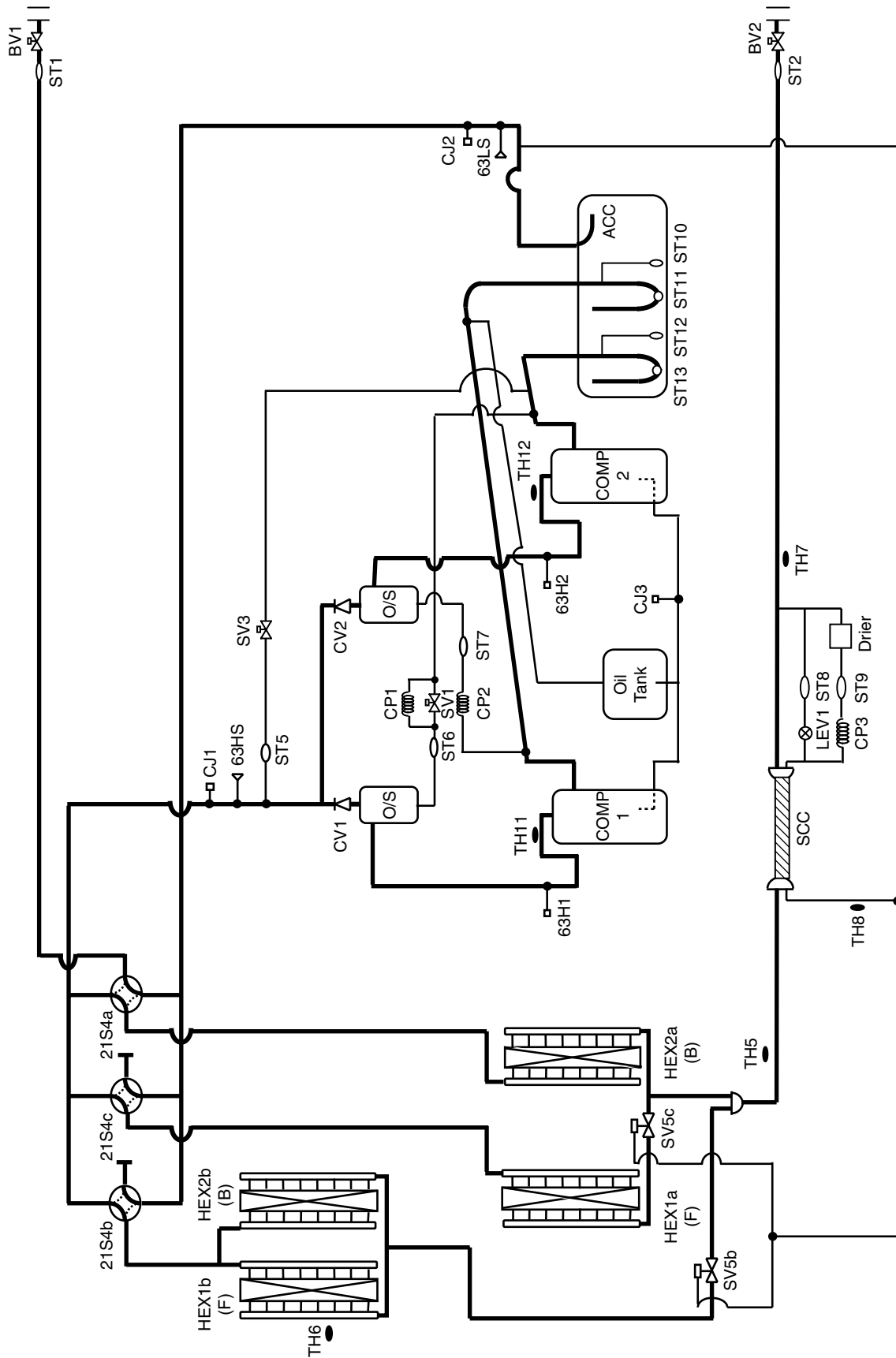

## [2] Functions of Principal Parts

### 1. Outdoor Unit

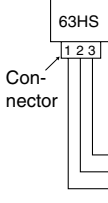
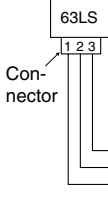
Name	Symbol (function)	Notes	Function	Specification	Check method
Compressor	MC1 MC2		Adjusts the volume of circulating refrigerant by controlling the operating frequency with the operating pressure.	(P200-type) High-pressure shell scroll type Winding resistance 20°C : 0.72Ω (P250-P400 types) Low-pressure shell scroll type Winding resistance 20°C : 0.583Ω	
High-pressure sensor	63HS		① Detects high pressure ② Regulates frequency and protects high pressure.	 <p>63HS Pressure 0~4.15MPa Vout 0.5~3.5V 0.071V/0.098MPa Pressure [MPa] =1.38×Vout[V]-0.69 1 Gnd (Black) 2 Vout (White) 3 Vcc (DC5V) (red)</p>	
Low-pressure sensor	63LS		① Detects low-pressure ② Protects low-pressure	 <p>63LS Pressure 0~1.7MPa Vout 0.5~3.5V 0.173V/0.098MPa Pressure [MPa] =0.566×Vout[V]-0.283 1 Gnd (Black) 2 Vout (White) 3 Vcc (DC5V) (red)</p>	
Pressure switch	63H1 63H2	63H2 on P450-P650 types only	① Detects high pressure ② Protects high pressure	4.15MPa Set to OFF	
Thermistor	TH11, 12 (Discharge)	TH12 on P450-P650 types only	① Detects discharge temperature ② Protects high pressure	$R_{120}=7.465k\Omega$ $R_{25/120}=4057$ $R_t = 7.465 \exp\{4057(\frac{1}{273+t} - \frac{1}{393})\}$	Resistance value check
	TH5 (Piping temperature)		① Controls frequency ② Controls defrost during heating operation ③ Controls LEV1 by detecting sub cool at the heat exchanger outlet, using HPS data and TH5 reading.	$R_0=15k\Omega$ $R_{0/80}=3460$ $R_t = 15 \exp\{3460(\frac{1}{273+t} - \frac{1}{273})\}$ 0°C : 15kΩ 25°C : 5.3kΩ 10°C : 9.7kΩ 30°C : 4.3kΩ 20°C : 6.4kΩ 40°C : 3.1kΩ	Resistance value check
	TH6 (Outdoor air temperature)		① Detects outdoor temperature ② Controls fan operation		
	TH7 TH8		Controls LEV1, using TH5, TH7, and TH8		
	THHS Inverter heat sink temperature	Heat sink	Controls inverter cooling fan, using THHS temperature.	$R_0=17k\Omega$ $R_{25/120}=4170$ $R_t = 17 \exp\{4170(\frac{1}{273+t} - \frac{1}{323})\}$ 0°C : 181kΩ 25°C : 50kΩ 10°C : 105kΩ 30°C : 40kΩ 20°C : 64kΩ 40°C : 26kΩ	



Name	Symbol (function)	Notes	Function	Specification	Check method
Solenoid valve	SV1 Discharge-suction bypass		① High/low pressure bypass at starting and stopping, and capacity control during low-load operation ② High-pressure rise suppression	AC220~240V Open when energized Closed when not energized	Continuity check with a tester
	SV3 Discharge-suction bypass	P450-P650 types only	Provides compressor protection when Compressor No. 2 is at a stop		
	SV5b Heat exchanger capacity control		Controls outdoor unit heat exchanger capacity.	AC220~240V Closed when energized Open when not energized	
	SV5c Heat exchanger capacity control	P400-P650 types only			
Linear expansion valve	LEV1 (SC coil)		Adjusts the volume of bypass flow from the outdoor unit during cooling operation.	DC12V Opening of stepping motor driving valve 0-480 pulses (direct driven type)	Same as indoor LEV. The resistance value is not the same as that of the indoor LEV. (Refer to the section on LEV troubleshooting.)
Heater	CH11, 12 Crankcase heater	CH12 on P450-P650 types only	Heats refrigerants in the compressor.	Cord heater AC220~240V CH11,CH12.....1280Ω 45W	Resistance value check
4-way valve	21S4a		Switches between cooling and heating cycles.	AC220~240V De-energized : cooling cycle Energized : heating cycle	Continuity check with a tester
	21S4b		Switches between cooling and heating cycles. Controls outdoor unit heat exchanger capacity.		
	21S4c	P400-P650 types only	Switches between cooling and heating cycles. Controls outdoor unit heat exchanger capacity.	AC220~240V De-energized : cooling cycle (Outdoor unit heat exchanger capacity 100%) Energized : cooling cycle (Outdoor unit heat exchanger capacity 25%) or heating cycle	

## 2. Indoor Unit

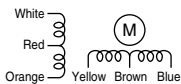
Name	Symbol (function)	Notes	Function	Specification	Check method
Linear expansion valve	LEV		① Adjusts superheat at the indoor heat exchanger outlet during cooling ② Adjusts subcool at the indoor heat exchanger outlet during cooling	DC12V Opening of stepping motor driving valve 0-1400 pulses	Refer to the section on continuity test with a tester Continuity between white-red-orange Continuity between yellow-brown-blue 
Thermistor	TH1 (Suction air temperature)		Indoor unit control (Thermo)	R <sub>0</sub> =15kΩ R <sub>0/80</sub> =3460 R <sub>t</sub> = $15 \exp\left\{3460\left(\frac{1}{273+t} - \frac{1}{273}\right)\right\}$ 0°C : 15kΩ    30°C : 4.3kΩ 10°C : 9.7kΩ    40°C : 3.1kΩ 20°C : 6.4kΩ 25°C : 5.3kΩ	Resistance value check
	TH2 (Piping temperature)		① Indoor unit control (Anti-freeze/heat adjustment) ② LEV control during heating operation (subcool detection)		
	TH3 (Gas-side piping temperature)		LEV control during cooling operation (superheat detection)		
	TH4 (Outdoor air temperature)		Indoor unit control (Thermo)		
	Temperature sensor (Indoor air temperature)		Indoor unit control (Thermo)		

## 7 Control

### [1] Dip Switch Functions and Their Factory Settings

#### 1. Outdoor unit

##### (1) Main board

Switch	Function	Function according to switch setting		Switch setting timing		
		OFF	ON	OFF	ON	
SWU	1~2	Unit address setting		Set to 00 or 51-100 with the dial switch		Before power on
SW1	1~10	For self-diagnosis/operation monitoring		Refer to the LED monitor display on the outdoor unit board		Anytime after power on
SW2	1	Centralized control switch	Not connected to the centralized control	Connected to the centralized control	Before power on	
	2	Deletion of connection information	Ordinary control	Deletion	Before power on	
	3	Deletion of error history	Storage of IC/OC error history	Deletion of IC/OC error history	Anytime after power on (When switched from OFF to ON)	
	4	Refrigerant amount adjustment	Ordinary control	Refrigerant amount adjustment mode	Anytime after power on (Except during initial start up mode/becomes ineffective 2 hours after compressor start up)	
	5	—	—	—	—	
	6	—	—	—	—	
	7	Forced defrost	Ordinary control	Start forced defrosting	10 minutes after compressor start up	Anytime after power on (When switched from OFF to ON)
	8	Defrost timer setting	50 minutes	90 minutes	Anytime after power on (When switched from OFF to ON)	
	9	—	—	—	—	
	10	—	—	—	—	
SW3	1	Test run: valid/invalid	SW3-2 invalid	SW3-2 valid	Anytime after power on	
	2	Test run: ON/OFF	Stops all ICs	Test runs all ICs	After power on and when SW3-1 is on.	
	3	Defrost start temperature	-10 (-8 for 400-type units and above)	-7 (-5 for 400-type units and above)	Anytime after power on	
	4	Defrost end temperature	10 (7 for 400-type units and above)	15 (12 for 400-type units and above)	Anytime after power on (except during defrost operation)	
	5	—	—	—	—	
	6	Pump down operation	Ordinary control	Pump down operation	After power on and while compressor is stopped	
	7	Heating Tcm	49°C	53°C	Anytime after power on	
	8	—	—	—	—	
	9	Unit model selection	Refer to the next page		Before power on	
	10	—	—	—	—	
SW4	1	—	—	—	—	
	2	—	—	—	—	
	3	—	—	—	—	
	4	Emergency operation valid/invalid	Valid	Invalid	Anytime after power on	
	5	—	—	—	—	
	6	—	—	—	—	
	7	Night mode/Step demand	Night mode	Demand function	Before power on	
	8	—	—	—	—	
	9	—	—	—	—	
	10	—	—	—	—	
SW5	1	Unit model selection	Refer to the next page		Before power on	
	2	—	—	—	—	
	3	—	—	—	—	
	4	—	—	—	—	
	5	—	—	—	—	
	6	—	—	—	—	
	7	—	—	—	—	
	8	—	—	—	—	
	9	—	—	—	—	
	10	—	—	—	—	

Note: All are set to OFF at factory shipment

DipSW3-9 \ DipSW5-1	OFF	ON
OFF	Standard specification	Standard specification
ON	High-static pressure (60Pa) specification	High-static pressure (30Pa) specification

(2) INV board

Switch	Function	Function according to switch setting		Switch setting timing		
		OFF	ON	OFF	ON	
SW1	1	Enabling/disabling the following error detection functions: ACCT, DCCT sensor circuit error (530X Detail No. 115, 116) ACCT, DCCT sensor error (530X Detail No. 117, 118) IPM open/Disconnected CNCT2 (530X Detail No. 119) Detection of erroneous wiring (530X Detail No. 120)	Error detection enabled	Error detection disabled	Anytime after power on	
	2	—	—	—	—	
	3	—	—	—	—	
	4	—	—	—	—	
	5	—	—	—	—	
	6	—	—	—	—	
SW2	1	Inverter address	0	1	Always leave it to ON	
	2	—	—	—	—	
	3	—	—	—	—	
	4	—	—	—	—	

Note 1 Except for SW2-1, all are set to OFF at factory shipment.

Unless otherwise specified, set the switch to OFF where indicated by “—,” which may be set to a certain setting for a reason.

Note 2 Leave SW1-1 off during normal operation. If it is turned on, errors cannot be detected and the unit may be damaged.

(3) FAN board

Switch	Function	Function according to switch setting		Switch setting timing		
		OFF	ON	OFF	ON	
SW2	1	Inverter address	0	5	Always leave it to ON	
	2	—	—	—	—	
	3	—	—	—	—	
	4	—	—	—	—	

Note 1 Except for SW2-1, all are set to OFF at factory shipment.

Unless otherwise specified, set the switch to OFF where indicated by “—,” which may be set to a certain setting for a reason.

## 2. Indoor unit

### DIP SW1, 3

Switch	Function	Function according to switch operation		Switch set timing		Remarks
		OFF	ON	OFF	ON	
SW1	1	Room temp. sensor position	Indoor unit inlet	Built in remote controller	At unit stopping (at remote controller OFF)	
	2	Clogged filter detect.	None	Provided		
	3	Filter duration	100h	2500h		
	4	OA intake	Ineffective	Effective		Always ineffective for PKFY-P.VAM
	5	Remote display select.	Fan output display	Thermo. ON signal display		
	6	Humidifier control	At stationary heating	Always at heat.		
	7	Heating thermo. OFF airflow	Very low speed	Low speed		
	8	Heating thermo. OFF airflow	SW1-7 setting	Set airflow		
	9	Power failure automatic return	Ineffective	Effective		
	10	Power source start/stop	Ineffective	Effective		
SW3	1	Model selection	Heat pump	Cooling only		
	2	Louver <small>{ Cooling capacity saving for PKFY-P. VAM, effective/ineffective }</small>	None	Provided		
	3	Vane	None	Provided		
	4	Vane swing function	None	Provided	Not provided for PKFY-P.VAM	
	5	Vane horizontal angle	1st setting	2nd setting		
	6	Vane angle set for cooling	Down blow B, C	Horizontal	Always down blow B,C for PKFY-P.VAM	
	7	-	-	-		
	8	Heating 4K up	Effective	Ineffective	Ineffective (ON) setting for floorstanding	
	9	-	-	-		
	10	-	-	-		

Note: When both SW1-7 and SW1-8 are being set to ON, the fan stops at the heating thermostat of OFF.

### Setting of DIP SW2

Model	P20	P25	P32	P40	P50	P63	P71
Capacity code (model name)	4	5	6	8	10	13	14
SW2 setting	ON OFF	ON OFF	ON OFF	ON OFF	ON OFF	ON OFF	ON OFF



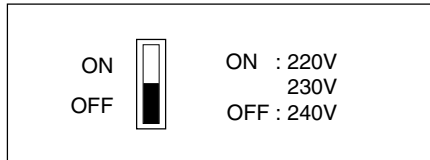
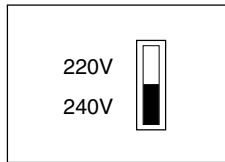

Model	P80	P100	P125	P140	P200	P250
Capacity code (model name)	16	20	25	28	40	50
SW2 setting	ON OFF	ON OFF	ON OFF	ON OFF	ON OFF	ON OFF

### Setting of DIP SW5

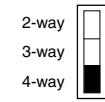
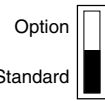

(PLFY-P-VLMD-E)

Switch	Function	Operation by switch	Switch set timing																
SWA	Ceiling height setting	<p>(PCFY-P-VGM-E)</p>  <table border="1" data-bbox="590 851 813 985"> <thead> <tr> <th colspan="2">Ceiling height</th> </tr> </thead> <tbody> <tr> <td>3</td> <td>3.5m</td> </tr> <tr> <td>2</td> <td>2.8m</td> </tr> <tr> <td>1</td> <td>2.3m</td> </tr> </tbody> </table>	Ceiling height		3	3.5m	2	2.8m	1	2.3m	Always after powering								
Ceiling height																			
3	3.5m																		
2	2.8m																		
1	2.3m																		
SWA	External static pressure setting	<p>(PDFY-P20 ~ 80VM-E, PEFY-P20 ~ 80VMM-E)</p>  <p>100Pa 50Pa 30Pa</p> <p>For other models, change the setting of static pressure by replacing the connector.</p>	Always after powering																
SWB	Setting of air outlet opening	<p>(PLFY-P-VAM-E)</p>  <table border="1" data-bbox="813 1276 1133 1545"> <thead> <tr> <th>SWB \ SWA</th> <th>1</th> <th>2</th> <th>3</th> </tr> </thead> <tbody> <tr> <td>2-way</td> <td>4.0m (3.3m)</td> <td>4.2m (3.5m)</td> <td>-</td> </tr> <tr> <td>3-way</td> <td>3.6m (3.0m)</td> <td>4.0m (3.3m)</td> <td>4.2m (3.5m)</td> </tr> <tr> <td>4-way</td> <td>3.2m (2.7m)</td> <td>3.6m (3.0m)</td> <td>4.2m (3.5m)</td> </tr> </tbody> </table> <p>Values in the parentheses are for P32~80 types.</p>	SWB \ SWA	1	2	3	2-way	4.0m (3.3m)	4.2m (3.5m)	-	3-way	3.6m (3.0m)	4.0m (3.3m)	4.2m (3.5m)	4-way	3.2m (2.7m)	3.6m (3.0m)	4.2m (3.5m)	Always after powering
SWB \ SWA	1	2	3																
2-way	4.0m (3.3m)	4.2m (3.5m)	-																
3-way	3.6m (3.0m)	4.0m (3.3m)	4.2m (3.5m)																
4-way	3.2m (2.7m)	3.6m (3.0m)	4.2m (3.5m)																
SWC	Airflow control	<p>(PLFY-P-VAM-E, PCFY-P-VGM-E, PKFY-P-VGM-E, PDFY-P-VM-E)</p>  <p>Option Standard</p> <p>Set to the option to install the high efficiency filter.</p>	Always after powering																

### 3. Remote controller

#### (1) MA remote controller (PAR-20MAA)

Removing the cover shows switches at the lower part of the remote controller unit. By operating these switches, the remote controller main/sub, and other function will be set.

In normal case, do not change the setting except No.1 switch used to set the main/sub. (All setting at factory shipment are "ON.")

Remote controller unit

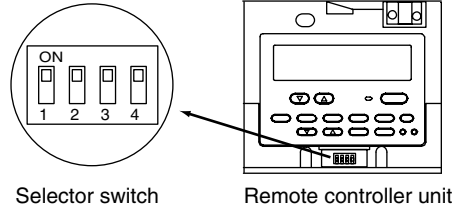

Switch	Function	ON	OFF	Action by switching	Switch set timing
1	Remote controller main/sub	Main	Sub	Sets one to "Sub" when connecting 2 sets in 1 group.	Before powering
2	At powering of remote controller	Normal start up	Timer mode start up	Sets to "Timer mode start up" so desired at power failure return when the schedule timer is connected.	Before powering
3	Cooling/heating display at automatic setting	Yes	No	Sets to "No" when not desiring to display "Cooling" or "Heating."	Before powering
4	Inlet temperature display	Yes	No	Sets to "No" when not desiring to display inlet temperature.	Before powering

#### (2) ME remote controller (PAR-F27MEA)

Set the address of the remote controller with the rotary switch.

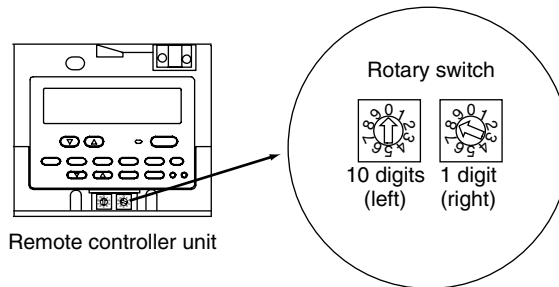

Example: In case of address 108

	Address setting range	Setting method
Main remote controller	101 ~ 150	Set to the lowest indoor main unit address + 100.
Sub remote controller	151 ~ 200	Set to the lowest indoor main unit address + 150.

Setting of rotary switch	Address No.
01 ~ 99	101 ~ 199 being added with 100
00	200

Note : To set addresses, use a precision screwdriver [(-), 20mm (w)], and apply load less than 19.6N.  
Operating with a method other than above may damage the rotary switch.

※ The address No. that can be set with ME remote controller is limited to 101 ~ 200.

The position of 100 will automatically be fixed to [1] when setting to "01 ~ 99", while it will automatically be fixed to [2] when setting to "00."

※ At factory shipment, the rotary switch was set to 01.

## [2] Controlling the Outdoor Unit

### 1. Initial control

- When the power is turned on, the initial processing of the microcomputer is given top priority.
- During the initial processing, control processing of the operation signal is suspended. The control processing is resumed after the initial processing is completed.  
(Initial processing: processing of the data inside the microcomputer and initial setting of each LEV opening, requiring up to approximately 2 minutes.)
- During the initial processing, the LED monitor on the outdoor unit's main board displays "S/W version", "refrigerant type", "heat pump", "cooling only and capacity" in turn every second.

### 2. Control at start-up

- The upper limit of frequency during the first 3 minutes of the operation is 50Hz.
- When the power is turned on, normal operation will start after the initial start-up mode (to be described later) has been completed (with a restriction on the frequency).

### 3. Bypass control

Bypass solenoid valves (P200-P400: SV1, P450-P650: SV1, SV3), which bypass the high- and low- pressure sides, operate in the following manner.

(1) Bypass solenoid valve (SV1) (ON = Open)

Operation Timing	SV1	
	ON (Open)	OFF (Close)
At No. 1 compressor start up or at No. 2 compressor start up (P450-P650 types only)	ON for 4 minutes	
After the restoration of thermo or 3 minutes after restart	ON for 2 minutes	
During cooling or heating operation with the compressor stopped	Always ON. (Exception : OFF when HPS-LPS $\leq$ 0.2MPa)	
After the operation has stopped	ON for 3 minutes. (Exception : OFF when HPS $\leq$ 0.2MPa)	
During defrost operation (See figure *1 below)	Always ON	
During oil-recovery operation	Always OFF during cooling operation and always ON during heating operation when running an oil-recovery operation after running a continuous operation at low frequency.	
During an operation with the compressor running at 30Hz When low pressure (LPS) drops (After 3 minutes have past since start up)	When low pressure (LPS) drops below 0.23 MPa.	When low pressure (LPS) exceeds 0.38 MPa.
When high pressure (Pd) rises	When Pd exceeds 3.77 MPa	When Pd is or below 3.43MPa and 30 seconds has passed

#### [ Example of an SV1 operation ]

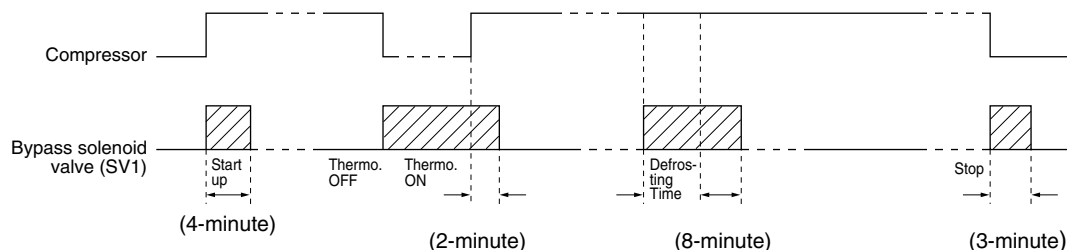

(2) Bypass Valve (SV3, P450-P650 types only) (ON = Open)

- The opening SV3 is controlled by the configuration of No.1 and No.2 compressor operations.

No.1 Compressor	No.2 Compressor	SV3
Stopped	Stopped	OFF
In operation	Stopped	ON
In operation	In operation	OFF

#### 4. Frequency control

- Depending on the capacity required, the frequency of the compressor is controlled to keep constant the evaporation temperature (0°C = 0.71MPa) during cooling operation and condensing temperature (49°C = 2.88MPa) during heating operation.
- The capacity of the P200-P400 is controlled solely by the inverter-driven compressor, and the capacity of P450-P650 is controlled by No.1 and No.2 compressors.
- The following table shows the frequency change of the inverter compressor during normal operation.

Model	Frequency/cooling	Frequency/heating	Speed
P200 type	30~81Hz	30~92Hz	3Hz/sec.
P250 type	20~69Hz	20~85Hz	3Hz/sec.
P300 type	20~83Hz	20~98Hz	3Hz/sec.
P350 type	20~99Hz	20~106Hz	3Hz/sec.
P400 type	20~100Hz	20~103Hz	3Hz/sec.
P450 type (50/60Hz)	20~70/56Hz	20~83/73Hz	3Hz/sec.
P500 type (50/60Hz)	20~85/73Hz	20~92/84Hz	3Hz/sec.
P550 type (50/60Hz)	20~96/88Hz	20~99/93Hz	3Hz/sec.
P600 type (50/60Hz)	20~104/98Hz	20~109/105Hz	3Hz/sec.
P650 type (50/60Hz)	20~112/107Hz	20~120/113Hz	3Hz/sec.

※ The maximum frequency during heating operation is affected by the outdoor air temperature to a certain extent.

##### (1) No. 2 compressor operation/stop (P450-P650 types only)

- ① No. 2 compressor going from stop to in-operation  
When No.1 compressor does not meet the capacity requirement, No.2 compressor will start its operation.
- ② No. 2 compressor going from in-operation to stop  
When an operation of both No.1 and No.2 compressors exceeds the capacity requirement, No.2 compressor will stop its operation.

##### (2) Pressure limit

The maximum limit of high pressure (Pd) is set for each frequency level. If this limit is exceeded, the frequency will be reduced every 30 seconds.

##### (3) Discharge temperature limit

The discharge temperature (Td) of the compressor in operation is detected, and if it exceeds the upper limit, the frequency is reduced by 5 Hz.

- Control is performed 30 seconds after compressor start-up and every 30 seconds thereafter.
- Operating temperature is 105°C for P200 type and 115°C for P250-P650 types.

##### (4) Periodic frequency control

Frequency control other than the ones performed at startup, upon status change, and for protection is called periodic frequency control (consent control) and is performed in the following manner.

###### ① Periodic control cycle

Periodic control is performed after the following time has passed

- (a) 30 seconds after either compressor start up or the completion of defrost operation
- (b) 30 seconds after frequency control by discharge temperature or by pressure limit

###### ② The amount of frequency change

The amount of frequency change is controlled to approximate the target value based on the evaporation temperature (Te) and condensing temperature (Tc).



## 5. Defrost operation control

### (1) Starting the defrost operation

- Defrost operation is started when the pipe temperature (TH5) of -10°C or below (-8°C or below for P400-type and above) has continuously been detected for 3 minutes after the integrated compressor operation time of 50 minutes have passed.
- If 10 minutes have passed since compressor start-up or since the completion of defrost operation, forced defrost operation will start by turning on the forced defrost switch (DIPSW2-7).
- Even if the defrost prohibit timer is set to 90 minutes, the actual defrost prohibit time for the next operation will be 50 minutes if defrosting took 15 minutes.

### (2) Defrost operation

Compressor frequency	Model	No.1 Compressor	No. 2 Compressor
		P200 type	72
	P250 type	53	—
	P300 type	65	—
	P350 type	65	—
	P400 type	114	—
	P450 type (50/60Hz)	110/100	ON (50/60Hz)
	P500 type (50/60Hz)	110/100	ON (50/60Hz)
	P550 type (50/60Hz)	110/100	ON (50/60Hz)
	P600 type (50/60Hz)	110/100	ON (50/60Hz)
	P650 type (50/60Hz)	110/100	ON (50/60Hz)
Outdoor unit fan	Stopped		
SV1	ON		
SV3 (P450-P650 types only)	ON		
21S4a	OFF		
21S4b	OFF		
21S4c (P400-P650 types only)	OFF		
SV5b	OFF		
SV5c (P400-P650 types only)	OFF		
LEV1	480 pulses		

### (3) Completion of defrost operation

- Defrost operation will stop when 12 minutes have past since the beginning of defrost operation (15 minutes when the defrost prohibit timer is set to 90 minutes), or when the piping temperature (TH5) of 10°C or above has been continuously detected for 2 minutes. (TH5 above 7°C for 2 minutes for P400 models and above)
- Defrost operation will not stop its operation for 2 minutes once started unless the piping temperature exceeds 25°C within 2 minutes, in which case the operation will stop.  
(Above 20°C within 2 minutes for P400 type models and above)

### (4) Problems during defrost operation

- If a problem is detected during defrost operation, the operation will be stopped, and the defrost prohibition time based on the integrated compressor operation time will be set to 20 minutes.

### (5) Change in the number of operating indoor units during defrost operation

- Even when there is a change in the number of operating indoor units during defrost operation, the operation will continue, and an adjustment will be made after the completion of the defrost operation.
- Defrost operation will be continued, even if the indoor units stop or if thermo is turned off, until it has run its course.

## 6. Refrigerant recovery control

- Recovery of refrigerant is performed during heating operation to prevent the refrigerant from accumulating inside the unit while it is stopped (unit in fan mode), or inside the indoor unit that is in cooling mode or in heating mode with thermo off.

It is also performed during cooling operation to prevent an excessive amount of refrigerant from accumulating in the outdoor heat exchanger.

### [During heating operation]

#### (1) Initiation of refrigerant recovery

- Recovery of refrigerant during heating operation begins when all of the following three conditions are met:
  - 15 minutes have past since the completion of previous refrigerant recovery.
  - $T_d > 105^\circ\text{C}$  (P200 type),  $115^\circ\text{C}$  (P250-P650)
  - Frequencies below 50 Hz

#### (2) Refrigerant recovery

- Refrigerant is recovered with the LEV on the applicable indoor unit (unit under stopping mode, fan mode, cooling, heating with thermo off) being opened for 30 seconds.
- Periodic capacity control of the outdoor units and periodic LEV control of the indoor units will be suspended during refrigerant recovery operation; they will be performed after the recovery has been completed.
- Defrost operation will be suspended until refrigerant recovery has been completed.

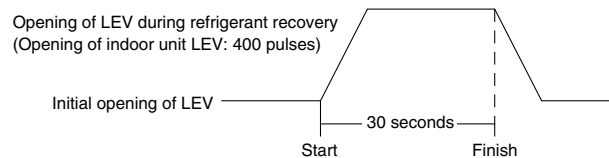

### [During cooling operation]

#### (1) Initiation of refrigerant recovery

- Recovery of refrigerant during cooling operation begins when all of the following conditions are met:
  - 30 minutes have past since the completion of previous refrigerant recovery.
  - When discharge temperature has remained above the limit continuously.
  - $T_d > 95^\circ\text{C}$  (P200 type),  $105^\circ\text{C}$  (P250-P650) or [ $P_d > 3.43\text{MPa}$  ( $35\text{kg/cm}^2\text{G}$  and  $SC0 > 10\text{deg}$ )]

#### (2) Refrigerant recovery

- Increase the opening of LEV1 (Periodic control begins when 30 seconds have elapsed).

## 7. Outdoor unit fan

### (1) Control method

- The air volume of outdoor unit fan is controlled by the inverter control to maintain a constant evaporation temperature ( $0^\circ\text{C} = 0.71\text{MPa}$ ) during cooling operation and constant condensing temperature ( $49^\circ\text{C} = 2.88\text{MPa}$ ) during heating operation, depending on the required capacity.
- The capacity of the outdoor unit heat exchanger is controlled by the 4-way valve (21S4b, 21S4c) or the solenoid valve (SV5b, SV5c) (21S4c and SV5c for P400-P650 types only).

### (2) Control

- Outdoor unit fan stops while the compressor is stopped (except when there is an input from snow sensor).
- The fan operates at full speed for 5 seconds after start up (except the units with high static pressure specifications).
- The outdoor unit fan stops during defrost operation.

(3) Patterns of outdoor unit heat exchanger capacity control

**[P200-P350types]**

Operation mode	Heat exchanger capacity	Inverter control	Remarks
Cooling	50%	5~100%	21S4b ON SV5b ON
	100%	10~100%	21S4b OFF SV5b OFF
Heating	100%	10~100%	21S4b ON SV5b OFF
Defrost	100%	0%	21S4b OFF SV5b OFF

**[P400-P650types]**

Operation mode	Heat exchanger capacity	Number of fans	Inverter control	Remarks
Cooling	25%	1	5~100%	21S4b, 21S4c ON SV5b, SV5c ON
	50%	1	10~100%	21S4b ON, 21S4c OFF SV5b ON, SV5c OFF
	100%	2	15~100%	21S4b, 21S4c OFF SV5b, SV5c OFF
Heating	100%	2	10~100%	21S4b, 21S4c ON SV5b, SV5c OFF
Defrost	100%	0	0%	21S4b, 21S4c OFF SV5b, SV5c OFF

Note 1 : 21S4b and 21S4c are not energized during cooling cycle and energized during heating cycle.

Note 2 : SV5b and SV5c are not energized when it is open and energized when it is closed.

Note 3 : While the unit is stopped, 21S4b and 21S4c are not energized and in cooling cycle, and SV5b and SV5c are opened.

**8. Subcool coil control (Linear expansion valve <LEV1>)**

- The amount of super heat is controlled and kept constant based on the bypass outlet temperature (TH8) of subcool coil every 30 seconds.
- The degree of opening is controlled based on the subcool coil outlet/inlet temperature (TH5, TH7), high pressure (Pd), and discharge temperature.  
However, the LEV will be closed (0) during heating operation and when the compressor is stopped, and it will be open during cooling operation with thermo off.
- It stays open at 480 during defrost operation.

**9. Control at initial startup**

- If the unit is started within 2 hours of power on when the outdoor temperature is below a certain degree (below 5°C for cooling operation and below -5°C for heating operation), the unit will be on the stand-by mode and will not start for 30 minutes after power on. (P200 type only)
- When the unit is started for the first time, it will run the following course of operation.

**Flow chart of initial operation mode**

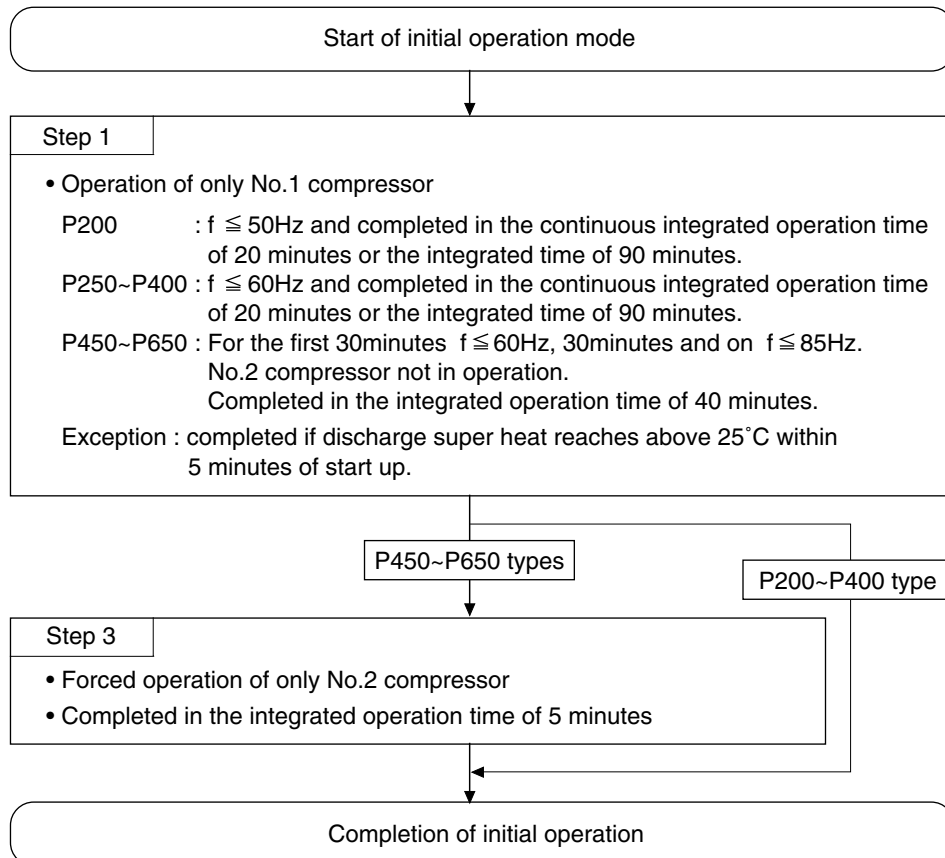

< Initial start-up control of P450-P650 type units: Time chart >

[Example1]

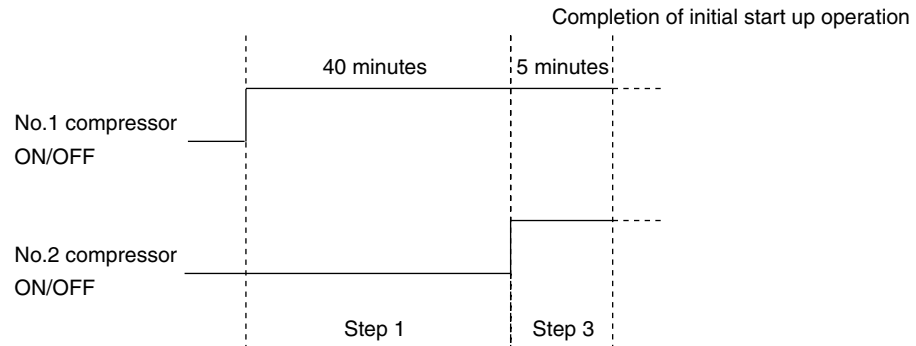

10. Emergency operation mode (P450-P650 types only)

Emergency operation mode is an operation that the unit runs on a first-aid basis when problems occur with the compressors (No.1, No.2). It can be started by performing an error reset on the remote controller.

(1) Starting an emergency operation

- ① Occurrence of error → error source and error code displays on the remote controller
- ② Error reset on the remote controller
- ③ If the remote controller displays the type of error that allows an emergency operation, (as in above) (refer to the table below) the unit will begin “retry” operation. (Same usual operation as the operation after error reset.)
- ④ When the same type of error is detected during the “retry” operation Item ③ above, perform another error reset on the remote controller and run an emergency operation suitable for the type of the error.

Pattern of emergency operation mode	Error source	Codes of the errors that allow an emergency operation	Codes of the errors that do not allow an emergency operation	Operation
Problems with No.1 (INV)	Outdoor unit	Heatsink thermistor 4230	All errors other than the ones listed on the left	Emergency operation with only No.2 compressor  ※ After a “retry” operation, if a different type of error that is listed under <Inverter error> on the left is detected, an emergency operation is run after a reset. 4250 → reset → retry → 4240 → reset → emergency operation
		<Inverter error>		
Over-current break 4250				
Overload protection 4240				
Heatsink overheat protection 4230				
Cooling fan error 4260				
Bus voltage drop protection 4220				
IDC sensor/circuit error 5301				
VDC sensor/circuit error 4200				
THHS sensor/circuit error 5110				
IPM communication error 0403				
Problems with No.2		Over-current protection 4108		Emergency operation with only No.1 compressor

(2) Finishing the emergency operation mode

[Finishing conditions]

When one of the following conditions is met, emergency operation will end.

- ① When an integrated operation time of compressor in cooling mode operation has reached 4 hours.
- ② When an integrated operation time of compressor in heating mode operation has reached 2 hours.
- ③ When an error is detected that does not allow the unit to run an emergency operation.

[Control at the completion of and after an emergency operation]

- To end the operation, stop the compressor and bring up the error code on the display on the remote controller.
- If another error reset is performed upon finishing an emergency operation, the unit will run a “retry” operation again and will repeat the procedures ① through ④ under section (1) above.
- To finish an emergency operation and to run a current-carrying operation after correcting the error, perform a power reset.

## 11. Operation mode

### (1) Indoor unit operation modes

An operation mode can be selected from the following 5 modes on the remote controller.

①	Cooling mode
②	Heating mode
③	Dry mode
④	Fan mode
⑤	Stopping mode

### (2) Outdoor unit operation mode

①	Cooling mode	All indoor units in operation are in cooling mode.
②	Heating mode	All indoor units in operation are in heating mode.
③	Stopping mode	All indoor units are in fan mode or stopping mode.

Note : If the outdoor unit is already in the cooling mode, other indoor units (in stopping mode, fan mode, thermo OFF) will not run a heating operation when directed to do so, and "HEAT" on the remote controller will blink. When the outdoor unit is already in the heating mode, the reverse will be true. (The first selection made on the remote controller has the priority.)

## 12. Demand control

Cooling/heating operation can be prohibited (thermo OFF) by an external input to the indoor units.

Note : When DIPSW4-7 are on, STEP DEMAND are possible. NIGHT MODE will become unavailable however.

SW4-7 : OFF (Compressor ON/OFF and NIGHT MODE)

CN3D 1-3P	Compressor ON/OFF	CN3D 1-2P	NIGHT MODE
OPEN	ON	OPEN	OFF
SHORT	OFF	SHORT	ON

SW4-7 : ON (STEP DEMAND)

	CN3D 1-2P	OPEN	SHORT
CN3D 1-3P			
OPEN		100% (no demand)	75%
SHORT		0%	50%

Note the following steps to be taken when using the STEP DEMAND

(Example) When switching from 100% to 50%

Demand control steps	(Wrong) 100% → 0% → 50%
	(Correct) 100% → 75% → 50%

If the step listed as the wrong example above is taken, thermo may go off.

The percentage of the demand listed in the table above is an approximate value based on the compressor volume and does not necessarily correspond with the capacity.

### [ Example of wiring connection ]

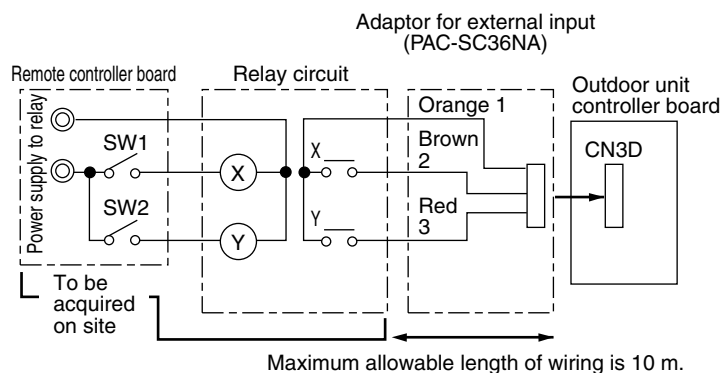

SW1 : NIGHT MODE or demand command  
 SW2 : Demand command  
 X, Y : Relay (contact rating DC1mA)

### [3] Operation Flow Chart

#### 1. Flow to determine the mode

(1) Indoor unit (cooling, heating, dry, fan mode)

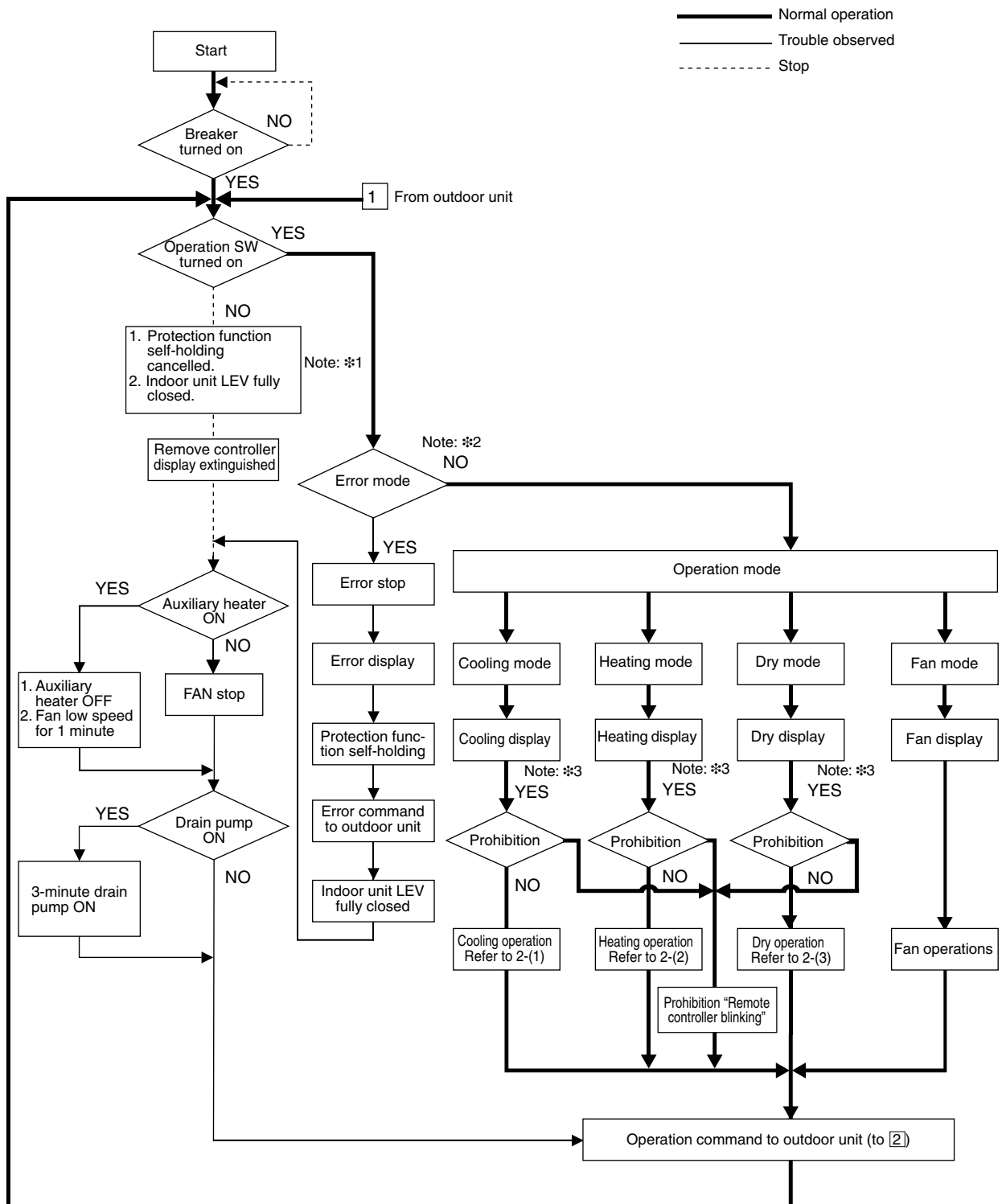

Notes :

\*1 Indoor unit LEV fully closed : Opening 41.

\*2 The error mode includes that of indoor units and outdoor units. At indoor side error (excluding water leak), the indoor unit in trouble only will be stopped in emergency, while at outdoor side error, all indoor units connected will be stopped.

\*3 Prohibition status is observed when the set cooling/heating mode is different from that of the outdoor unit.

(2) Outdoor unit (cooling, heating mode)

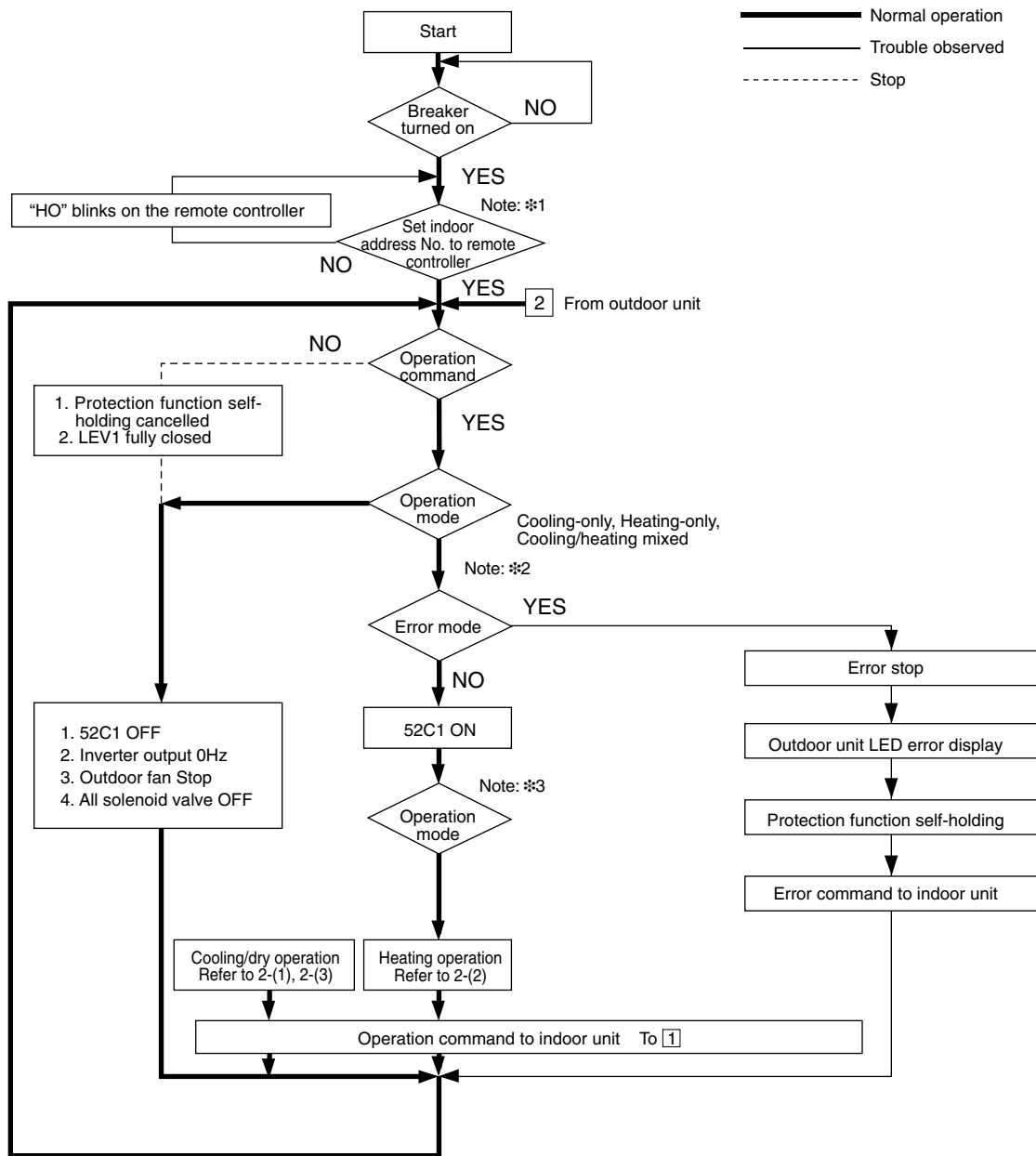

Notes :

- ※1 For about 3 minutes after turning on power source, address and group information of outdoor unit, indoor unit, and remote controller are retrieved by remote controller, during which “HO” blinks on and off on remote controller. In case indoor unit is not grouped to remote controller, “HO” display on remote controller continues blinking even after 3 minutes after turning on power source.
- ※2 Two trouble modes include indoor unit side trouble, and outdoor unit side trouble. In the case of indoor unit side trouble, error stop is observed in outdoor unit only when all the indoor units are in trouble. However, if one or more indoor units are operating normally, outdoor unit shows only LED display without undergoing stop.
- ※3 The operation mode conforms to mode command by indoor unit. However, when outdoor unit is under cooling operation, the operation of indoor unit will be prohibited even by setting indoor units under operation, or indoor unit under stopping or fan mode to heating mode. Reversely when outdoor unit is being under heating operation, the same condition will be commenced.

## 2. Operation under each mode

### (1) Cooling operation

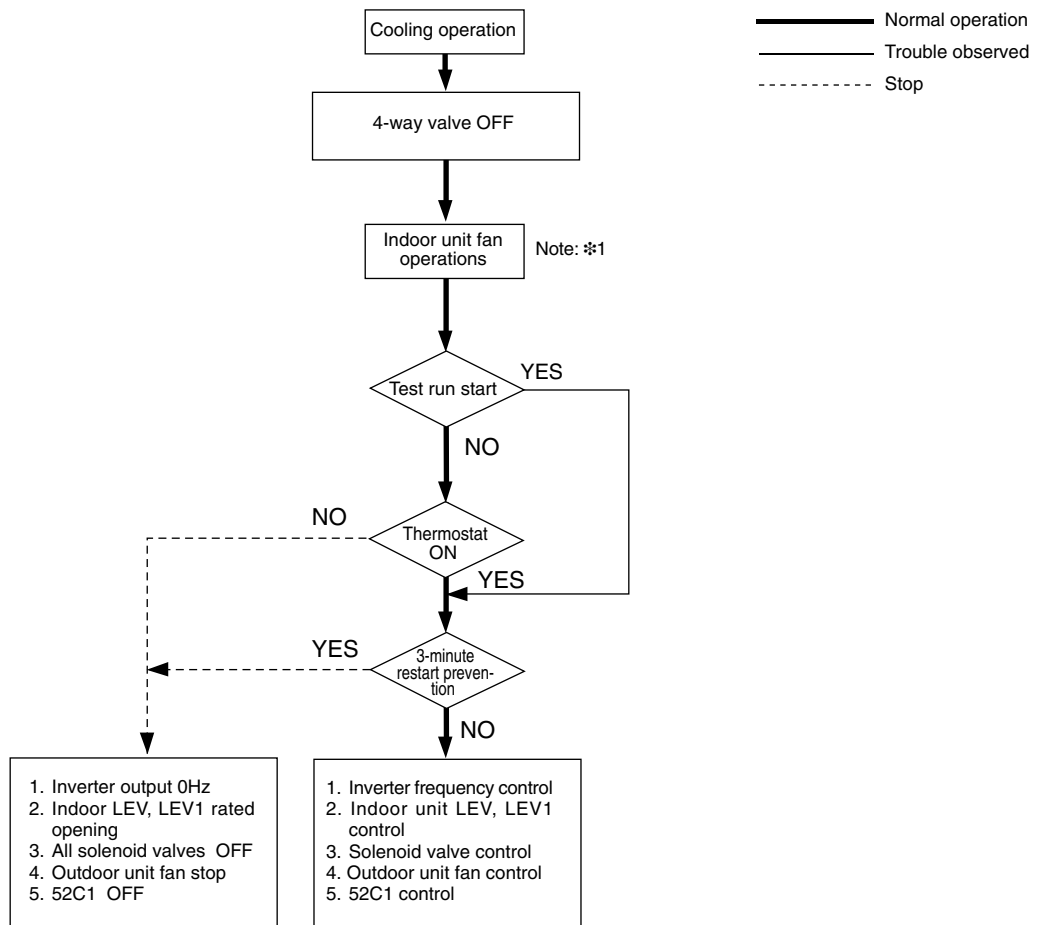

Note :

\*1 The indoor fan operates at the set notch under cooling regardless of thermostat ON/OFF.



(2) Heating operation

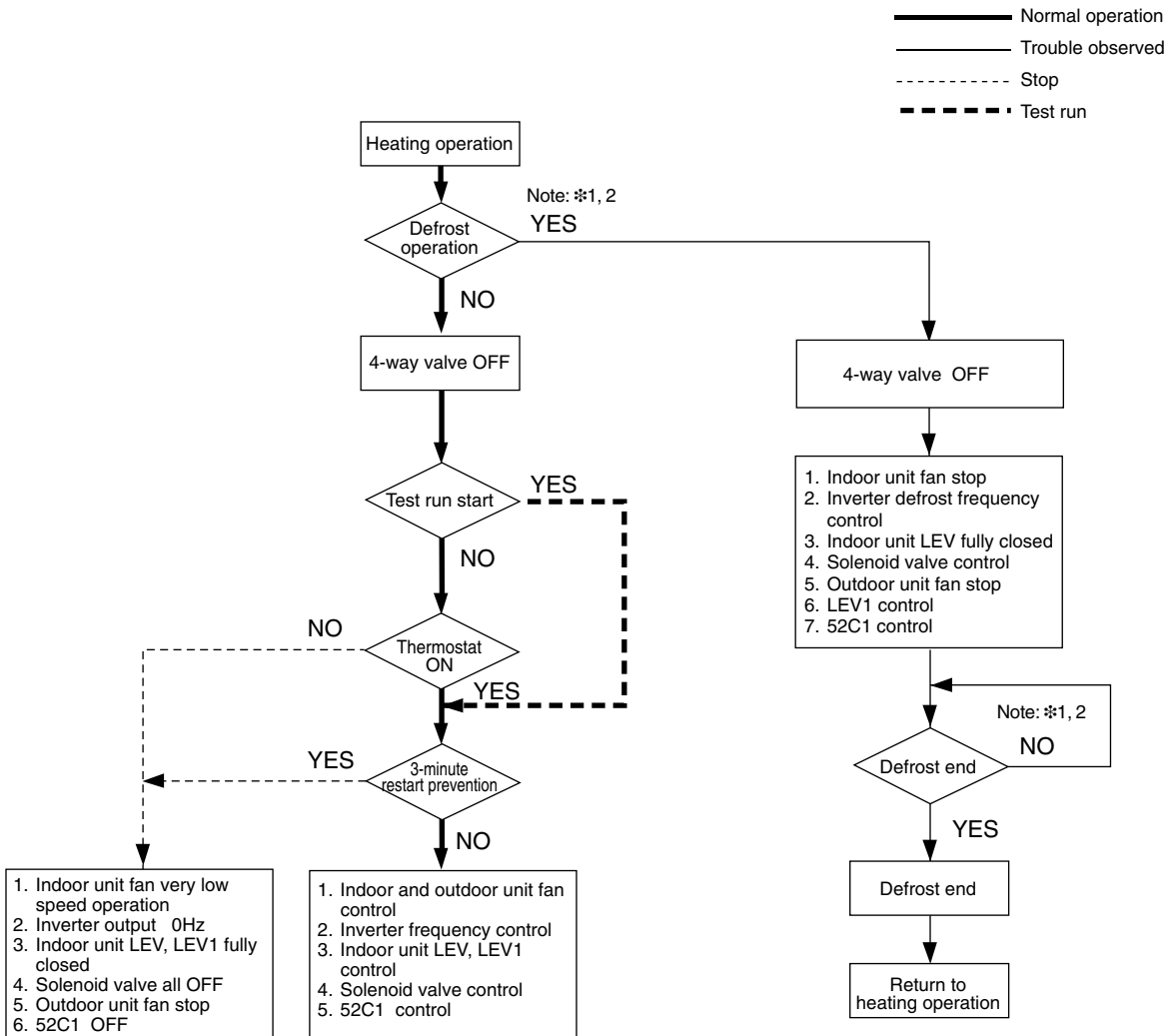

Notes :

- ※1 When outdoor unit starts defrosting, it transmits defrost operations command to indoor unit, and the indoor unit starts defrosting operations.  
Similarly when defrosting operation stops, indoor unit returns to heating operation after receiving defrost end command of outdoor unit.
- ※2 Defrost ending condition : Defrost operation for 10 minutes or more, or outdoor piping temperature : refer to "5. Defrost operation control" of [2] Controlling the Outdoor Unit.

(3) Dry operation

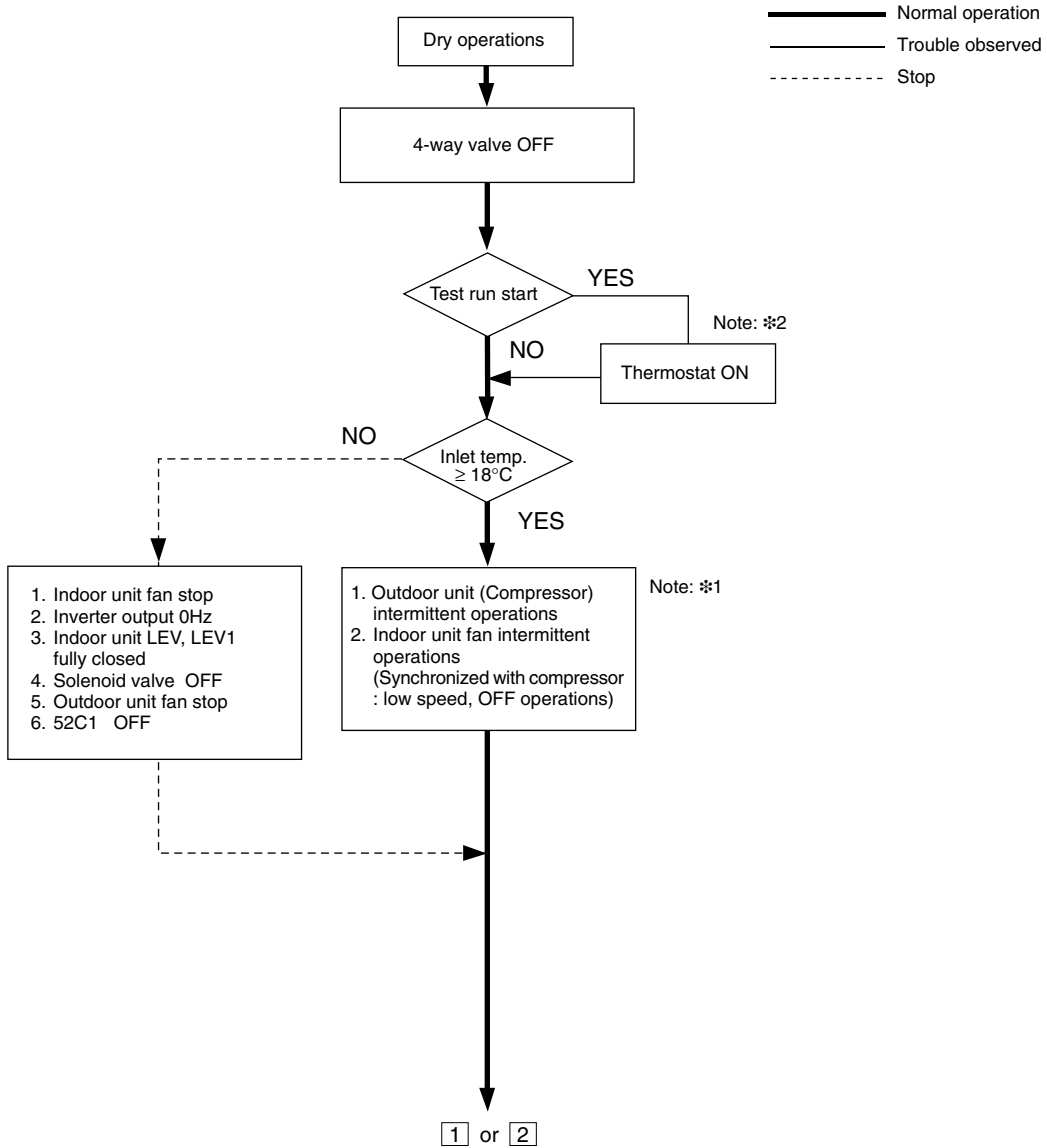

Notes :

- ※1 When indoor unit inlet temperature exceeds 18°C, outdoor unit (compressor) and indoor unit fan start intermittent operations synchronously. The fan always operates (at low speed) when it decreases below 18°C. Operations of outdoor unit, indoor unit LEV and solenoid valve accompanying compressor ON are the same as those in cooling operations.
- ※2 Thermostat is always kept on in test run, and indoor and outdoor unit intermittent operation (ON) time is a little longer than normal operations.

## 8 Test Run

### [1] Check Items before Test Run

1	Check refrigerant leak, loose power source or transmission line if found.
2	Measure resistance between the power source terminal block and ground with a 500V megger to confirm it is exceeding 1.0MΩ. Notes: 1. Do not operate the unit when the insulation resistance stays below 1.0MΩ. 2. Never apply a megger to the transmission line terminal block. Otherwise, the control board will be damaged. 3. At immediately after installation or when the unit is left with the main power source turned off for a long time, the insulation resistance between the power source terminal block and ground may drop down to 1MΩ approximately due to refrigerant accumulated inside the compressor. 4. When the insulation resistance counts for more than 1MΩ, power the crankcase heater for 12 hours or more by turning the main power source on. Doing this way evaporates refrigerant inside the compressor leading to increase the insulation resistance. 5. Never measure the insulation resistance of the transmission terminal block for the MA remote controller.
3	Confirm that the ball valves are fully opened at both gas and liquid sides. Note: 1. Make sure to tighten the cap.
4	Check the phase order of the 3-phase power source and the voltage between each phase. Note: 1. Open phase or reverse phase causes the emergency stop of test run. (4103 error)
5	[When connected to the transmission booster for transmission line] Before turning on the outdoor unit, turn on the transmission booster for transmission line. Notes: 1. When the outdoor unit is turned on first, connection information of refrigerant system may not be confirmed normally. 2. If the outdoor unit is turned on first, after turning on the transmission booster for transmission line, reset the power of the outdoor unit.
6	Turn the main power source on 12 hours at least before test run to power the crankcase heater. Note: 1. Shorter powering time may cause compressor trouble.

### [2] Test Run Method

※ The illustration shows MA remote controller.

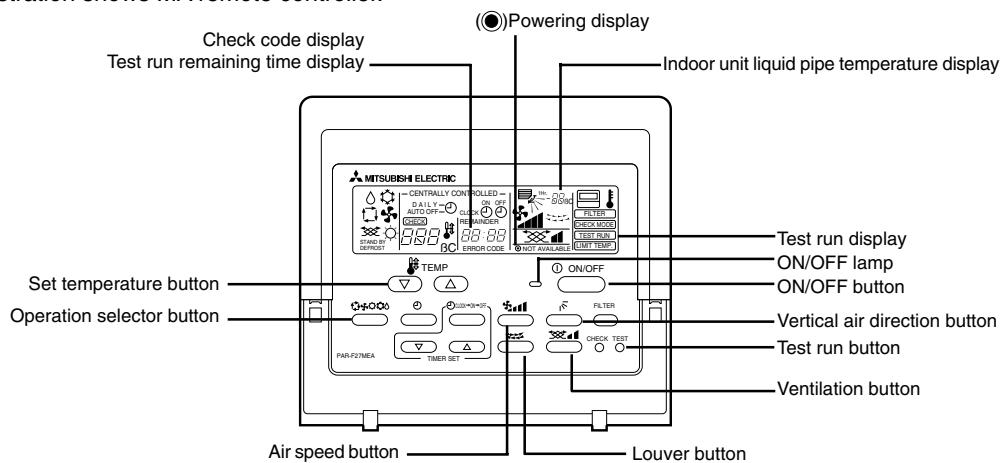

Operation procedure	
①	Turn on universal power supply at least 12 hours before getting started → Displaying "HO" on display panel for about 5 minutes
②	Press <b>TEST</b> button twice → Displaying "TEST RUN" on display panel
③	Press  selection button → Make sure that air is blowing out
④	Press  select button to change from cooling to heating operation, and vice versa → Make sure that warm or cold air is blowing out
⑤	Press  adjust button → Make sure that air blow is changed
⑥	Press  or  button to change wind → Make sure that horizontal or downward blow is adjustable.
⑦	Make sure that indoor unit fans operate normally
⑧	Make sure that interlocking devices such as ventilator operate normally if any
⑨	Press <b>ON/OFF</b> button to cancel test run → Stop operation
<p>Note 1: If check code is displayed on remote controller or remote controller does not operate normally.</p> <p>2: Test run automatically stops operating after two hours by activation of timer set to two hours.</p> <p>3: During test run, test run remaining time is displayed on time display section.</p> <p>4: During test run, temperature of liquid pipe in indoor unit is displayed on remote controller room temperature display section.</p> <p>5: When pressing  adjust button, depending on the model, "NOT AVAILABLE" may be displayed on remote controller. However, it is not a malfunction.</p> <p>6: When pressing  or  button, depending on the model, "NOT AVAILABLE" may be displayed on remote controller. However, it is not a malfunction.</p>	

### [3] Operating Characteristics and Refrigerant Amount

Clarify relationship between the refrigerant amount and operating characteristics of CITY MULTI new refrigerant series, and perform service activities such as decision and adjustment of refrigerant amount on the market.

#### 1. Operating characteristics and refrigerant amount

The followings are operating characteristics and refrigerant amount which draw special attention.

1	During cooling operation, the amount of refrigerant in the accumulator is the smallest when all indoor units are in operation.	
2	During heating operations, liquid level of accumulator is the highest when all the indoor units are operating.	
3	Tendency of discharge temperature	Discharge temperature is more likely to rise when there is a lack of refrigerant.
		Little change in discharge temperature is seen, even if the refrigerant is increased or decreased while there is refrigerant in the accumulator.
		Discharge temperature is more likely to rise when high-pressure is high. Discharge temperature is more likely to rise when the low temperature is low.
4	(P250-P650 types) Compressor shell temperature is 10~60K higher than low pressure saturation temperature (Tc) when refrigerant amount is appropriate. → Judged as over replenishment when temperature difference from low pressure saturation temperature (Te) is 5K or less. (P200 type) The shell temperature of the compressor is roughly equal to the discharge temperature. → Make a judgment from the discharge temperature	

### [4] Adjustment and Judgment of Refrigerant Amount

#### 1. Symptom

The symptoms shown in the table below are the signs of excess or lack of refrigerant amount. Be sure to adjust refrigerant amount in the refrigerant amount adjustment mode, by checking operation status, judging refrigerant amount and performing selfdiagnosis with LED, for overall judgment of excess or lack of refrigerant amount .

1	Emergency stop at 1500 remote controller display (excessive refrigerant replenishment)	Excessive refrigerant replenishment
2	Operating frequency does not fully increase, thus resulting in insufficient capacity	Insufficient refrigerant replenishment
3	Emergency stop at 1102 remote controller display (discharge temperature trouble)	

#### 2. Refrigerant volume

##### Checking the operating condition

Operate all the indoor units on cooling or on heating, checking the discharge temperature, sub-cooling, low pressure saturation temperature, inlet temperature, shell bottom temperature, liquid level, liquid step, etc. and renderinglan overall judgment.

Condition		Judgment
1	Discharge temperature is high. (Normal temperature: 95°C or below)	Refrigerant volume tends toward insufficient.
2	Low pressure is extremely low.	
3	Inlet superheating is high (if normal, SH = 20K or lower).	
4	(P250-P650 types) Shell bottom temperature is high (the difference with the low pressure saturation temperature ※1 is 60K or greater) (P200 type) The shell temperature of the compressor is roughly equal to the discharge temperature. → Make a judgment from the discharge temperature	Refrigerant volume tends toward overcharge.
	(P250-P650 types) Shell bottom temperature is low (the difference with the low pressure saturation temperature ※1 is 5K or higher.) (P200 type) The shell temperature of the compressor is roughly equal to the discharge temperature. → Make a judgment from the discharge temperature	
6	Inlet super heating is low (if normal, SH = 10K or higher).	

※1 Low pressure saturation temperature (Low pressure shell compressor)

### 3. Amount of additional refrigerant to be charged

At the time of shipping from the factory, the outdoor unit is charged with the amount of refrigerant shown in the following table, but since no extension piping is included, please carry out additional charging on-site.

Outdoor unit model name	P200	P250	P300	P350	P400	P450	P500	P550	P600	P650
Refrigerant charge volume	7.0kg	9.5kg	9.5kg	9.5kg	13.0kg	22.0kg	22.0kg	22.0kg	22.0kg	22.0kg

#### Calculation formula:

Calculate the additional refrigerant volume by calculating the size of the extension liquid piping and its length (unit : m)

$\text{Additional refrigerant volume (kg)} = (0.2 \times L_1) + (0.12 \times L_2) + (0.06 \times L_3) + (0.024 \times L_4) + \alpha$
--

- L1 : Length of  $\phi$  15.88 liquid pipe (m)
- L2 : Length of  $\phi$  12.7 liquid pipe (m)
- L3 : Length of  $\phi$  9.52 liquid pipe (m)
- L4 : Length of  $\phi$  6.35 liquid pipe (m)
- $\alpha$  : Refer to the right table.

Total capacity of connected indoor unit	$\alpha$
~ 80	1.0kg
81 ~ 160	1.5kg
161 ~ 330	2.0kg
331 ~ 480	2.5kg
481 ~ 630	3.0kg
631 ~ 710	4.0kg
711 ~ 890	5.0kg
891 ~ 1070	6.0kg

※ In the calculation results, round up fractions smaller than 0.01kg. (Example: 14.04kg → 14.1kg)

#### Example: PUHY-P650YGM-A

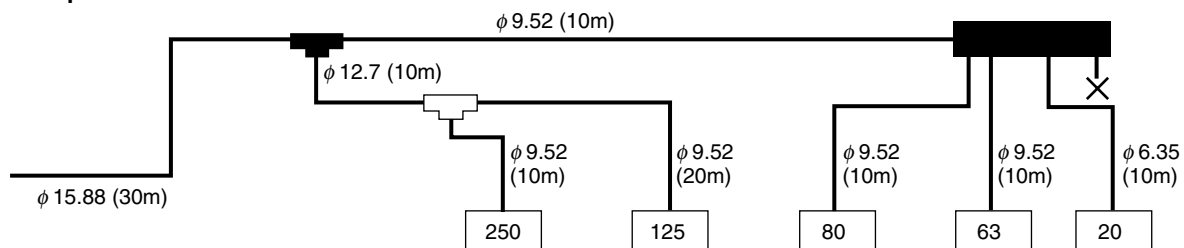

Each pipe is of liquid piping.

$\phi$  15.88 : 30m

$\phi$  12.7 : 10m

$\phi$  9.52 : 10m + 10m + 20m + 10m + 10m = 60m

$\phi$  6.35 : 10m

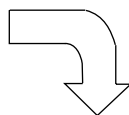

From the above calculation formula,

$\text{Additional charge volume} = (0.2 \times 30) + (0.12 \times 10) + (0.06 \times 60) + (0.024 \times 10) + 3 = 14.04\text{kg}$
--

14.04kg obtained is converted in a unit of 0.1kg.

Therefore,

$\text{Additional charge volume} = 14.1\text{kg}$
---

## [5] Refrigerant Volume Adjustment Mode Operation

Since the refrigerant volume adjustment introduced in this chapter is just for emergency need, correct adjustment to meet the rated refrigerant volume is difficult. Please judge for adequate volume by following the flow chart later under normal operation mode.

### 1. Procedure

Depending on the operating conditions, it may be necessary either to charge with supplementary refrigerant, or to drain out some, but if such a case arises, please follow the procedure given below

#### (1) Switching the function select switch (SW2-4), located on the outdoor unit's control board, ON starts refrigerant volume adjustment mode operation and the following operation occurs

Operation	The outdoor unit LEV1 diverges more than usual during cooling operation.
-----------	--

- Notes: 1. Even if the refrigerant volume has reached a suitable level shortly after starting refrigerant volume adjustment mode, if left for a sufficient length of time (once the refrigeration system has stabilized), there are times when this level may become unsuitable.
- 1) The refrigerant volume is suitable;
    - When the refrigerant volume for TH5 - TH7 is more than 5K at the outdoor unit, and 5 to 15K for SH at the indoor unit.
  - 2) The current volume is suitable, however, may become unsuitable after a certain length of time;
    - When the refrigerant volume for TH5 - TH7 is less than 5K at the outdoor unit, or less than 5K for SH at the indoor unit.
  2. There are times when it becomes difficult to determine the volume when performing refrigerant adjustments if the high pressure exceeds 2.0MPa.
  3. Based on the following flowchart, use TH11, TH5, TH7 and Tc to adjust the refrigerant volume. Use the self-diagnosis switch (SW1) on the outdoor unit main PCB to display TH11, TH5, TH7 and Tc.
  4. Refrigerant adjustment mode operation will automatically stop in 90 minutes. By turning off and on SW 2-4, the adjustment mode operation can be run again.

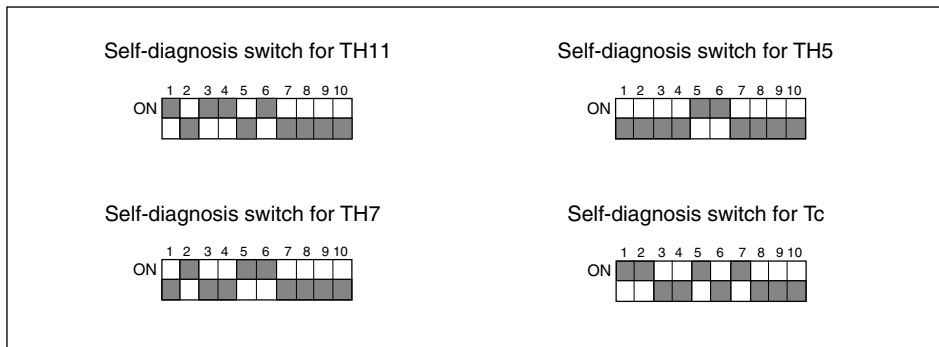

Using these, judge TH11, Tc - TH5 and Tc - TH7.

[ Refrigerant Adjustment Method ]

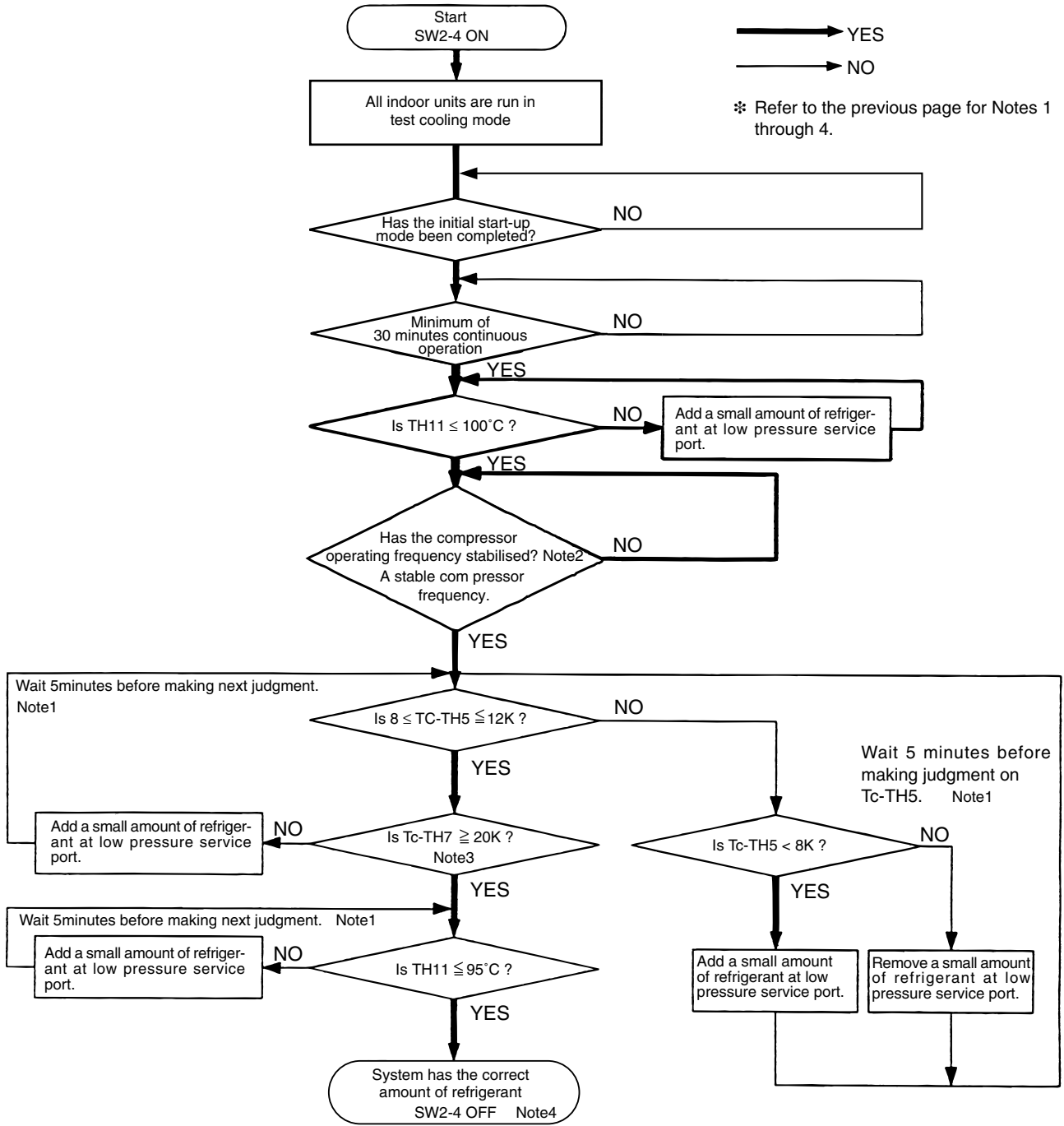

**⚠ Caution**  
 Ensure that no refrigerant is released into the atmosphere.

**⚠ Caution**  
 Use liquid refrigerant to fill the system.

- If gas refrigerant is used to seal the system, the composition of the refrigerant in the cylinder will change and performance may drop.

## [6] Symptoms that do not Signify Problems

Symptom	Remote controller display	Cause
Indoor unit does not run while operating for cooling (heating).	<b>"COOL (HEAT)" blinking display</b>	Unable to execute cooling (heating) operation while other indoor unit is under cooling (heating) operation.
Auto-vane runs freely.	<b>Normal display</b>	Because of the control action of the auto-vane, horizontal blow may be commenced automatically one hour after using for down blow in cooling. Horizontal blow will also be commenced at defrosting under heating, at the time of the hot adjust and the thermostat off.
Air speed setting switches over freely during heating operation.	<b>Normal display</b>	Very low speed operation is commenced at thermostat OFF. At thermostat ON, the very low speed operation automatically changes over to the set value by the time or piping temperature.
Fan stops during heating operation.	<b>Defrosting</b>	Fan stops under defrosting operation.
Fan does not stop while stopping operation.	<b>Extinguished</b>	When the auxiliary heater is turned on, fan operates for one minute after stopping to remove residual heat.
Air speed does not attain the set value even though turning operation switch to "ON."	<b>Preparing heating</b>	Very low speed for 5 minutes after SW "ON" or until the piping temperature reaches 35°C. Thereafter, the set value is commenced after low speed for 2 minutes. (Hot adjust control)
Outdoor unit does not run while starting operation.	<b>Normal display</b>	When outdoor unit is cooled down with refrigerant stagnated, operate the compressor for 35 minutes maximum to warm up. (model 200) Fan operation will be done during the warming up.
The display shown right will appear on the indoor unit remote controller for about 5 minutes when the main power source is turned on.	<b>"HO" blinking display</b>	The system is under starting up. Operate the remote controller after the blinking of "HO" is disappeared.
Drain pump does not stop while the operation is stopped.	<b>Extinguished</b>	At stopping of cooling operation, drain pump operates for 3 minutes further.
Drain pump runs even during unit stopping.		Run drain pump if drain water is generated even under stopping.



## [7] Standard Operation Data (Reference Data)

### 1. Cooling operation [Standard type]

Items			Outdoor unit		PU(H)Y-P200				PU(H)Y-P250				PU(H)Y-P300			
Condition	Ambient temp.	Indoor	DB/WB	27.0/19.0				27.0/19.0				27.0/19.0				
		Outdoor		35.0/24.0				35.0/24.0				35.0/24.0				
	Indoor unit	Quantity	Set	4				4				4				
		Quantity in operation		4				4				4				
		Model	–	71	63	50	20	100	71	63	20	125	80	63	32	
	Piping	Main pipe	m	5				5				5				
		Branch pipe		10				10				10				
		Total piping length		45				45				45				
	Indoor unit fan notch		–	Hi				Hi				Hi				
	Refrigerant volume		kg	11.0				13.9				13.9				
Outdoor unit	Total current		A	10.3/9.4				13.0/11.9				16.1/14.7				
	Volts		V	380/415				380/415				380/415				
	Compressor frequency		Hz	81				69				83				
LEV opening	Indoor unit		Pulse	253	441	362	187	325	253	441	187	387	275	441	261	
	SC (LEV1)			82				100				123				
Pressure	High pressure(after O/S) /Low pressure(before accumulator)		MPa	3.00/0.92				2.87/0.96				3.05/0.92				
Sectional temp.	Outdoor unit	Discharge (TH11)		°C	84				86				83			
		Heat exchanger outlet (TH5)			39				41				46			
		Accumulator	Inlet		14				14				14			
			Outlet		14				14				14			
		Suction (Compressor)			27				23				22			
		Shell bottom (Compressor)			80				39				44			
		SCC outlet (TH7)			19				20				21			
		Bypass outlet (TH8)			10				11				10			
	Indoor unit	LEV inlet			19				19				20			
		Heat exchanger outlet			13				13				13			

Items		Outdoor unit		PU(H)Y-P350				PUHY-P400				PUHY-P450				
Condition	Ambient temp.	Indoor	DB/WB	27.0/19.0				27.0/19.0				27.0/19.0				
		Outdoor		35.0/24.0				35.0/24.0				35.0/24.0				
	Indoor unit	Quantity	Set	4				4				4				
		Quantity in operation		4				4				4				
		Model		-	140	125	63	32	200	100	63	32	200	125	80	50
	Piping	Main pipe	m	5				5				5				
		Branch pipe		10				10				10				
		Total piping length		45				45				45				
	Indoor unit fan notch		-	Hi				Hi				Hi				
	Refrigerant volume		kg	14.7				18.2				21.6				
Outdoor unit	Total current		A	19.2/17.6				22.6/20.7				22.9/21.0				
	Volts		V	380/415				380/415				380/415				
	Compressor frequency (No.1/No.2)		Hz	99				100				50Hz : 70/50 60Hz : 56/60				
LEV opening	Indoor unit		Pulse	428	387	441	261	324	325	441	261	324	387	275	362	
	SC (LEV1)			140				164				183				
Pressure	High pressure(after O/S) /Low pressure(before accumulator)		MPa	3.21/0.87				2.91/0.94				2.95/0.86				
Sectional temp.	Outdoor unit	Discharge (TH11/TH12)		°C	88				86				82/85			
		Heat exchanger outlet (TH5)			46				45				41			
		Accumulator	Inlet		14				16				15			
			Outlet		14				16				15			
		Suction (Compressor)			24				23				21/17			
		Shell bottom (Compressor)			49				48				33/42			
		SCC outlet (TH7)			25				27				25			
		Bypass outlet (TH8)			10				11				9			
	Indoor unit	LEV inlet			24				26				24			
		Heat exchanger outlet			13				15				13			

Items		Outdoor unit		PUHY-P500				PUHY-P550				
Condition	Ambient temp.	Indoor	DB/WB	27.0/19.0				27.0/19.0				
		Outdoor		35.0/24.0				35.0/24.0				
	Indoor unit	Quantity	Set	4				4				
		Quantity in operation		4				4				
		Model	–	250	125	100	32	250	140	125	50	
	Piping	Main pipe	m	5				5				
		Branch pipe		10				10				
		Total piping length		45				45				
	Indoor unit fan notch		–	Hi				Hi				
	Refrigerant volume		kg	22.1				28.1				
Outdoor unit	Total current		A	26.3/24.0				28.8/26.4				
	Volts		V	380/415				380/415				
	Compressor frequency (No.1/No.2)		Hz	50Hz : 95/50 60Hz : 73/60				50Hz : 96/50 60Hz : 88/60				
LEV opening	Indoor unit		Pulse	388	387	325	261	388	373	387	362	
	SC (LEV1)			204				226				
Pressure	High pressure(after O/S) /Low pressure(before accumulator)		MPa	3.02/0.86				2.85/0.85				
Sectional temp.	Outdoor unit	Discharge (TH11/TH12)		°C	84/87				2.85/0.85			
		Heat exchanger outlet (TH5)			42				40			
		Accumulator	Inlet		15				15			
			Outlet		15				15			
		Suction (Compressor)			21/17				19/17			
		Shell bottom (Compressor)			37/42				42/42			
		SCC outlet (TH7)			25				24			
		Bypass outlet (TH8)			8				8			
	Indoor unit	LEV inlet			24				23			
		Heat exchanger outlet			13				13			

Items		Outdoor unit		PUHY-P600					PUHY-P650					
Condition	Ambient temp.	Indoor	DB/WB	27.0/19.0					27.0/19.0					
		Outdoor		35.0/24.0					35.0/24.0					
	Indoor unit	Quantity	Set	5					5					
		Quantity in operation		5					5					
		Model		–	200	200	125	50	25	250	200	125	50	25
	Piping	Main pipe	m	5					5					
		Branch pipe		10					10					
		Total piping length		55					55					
	Indoor unit fan notch		–	Hi					Hi					
	Refrigerant volume		kg	28.3					29.3					
Outdoor unit	Total current		A	29.6/27.1					33.1/30.3					
	Volts		V	380/415					380/415					
	Compressor frequency (No.1/No.2)		Hz	50Hz : 104/50 60Hz : 98/60					50Hz : 112/50 60Hz : 107/60					
LEV opening	Indoor unit		Pulse	324	324	387	362	222	388	324	387	362	222	
	SC (LEV1)			246					266					
Pressure	High pressure(after O/S) /Low pressure(before accumulator)		MPa	2.93/0.84					3.03/0.83					
Sectional temp.	Outdoor unit	Discharge (TH11/TH12)		°C	84/86					86/86				
		Heat exchanger outlet (TH5)			41					43				
		Accumulator	Inlet		15					14				
			Outlet		15					14				
		Suction (Compressor)			19/17					18/15				
		Shell bottom (Compressor)			47/43					53/49				
		SCC outlet (TH7)			24					26				
		Bypass outlet (TH8)			8					7				
	Indoor unit	LEV inlet			24					24				
		Heat exchanger outlet			12					12				

**2. Heating operation**  
**[Standard type]**

Items			Outdoor unit	PUHY-P200				PUHY-P250				PUHY-P300					
Condition	Ambient temp.	Indoor	DB/WB	20.0/-				20.0/-				20.0/-					
		Outdoor		7.0/6.0				7.0/6.0				7.0/6.0					
	Indoor unit	Quantity		Set	4				4				4				
		Quantity in operation			4				4				4				
		Model		-	71	63	50	20	100	71	63	20	125	80	63	32	
	Piping	Main pipe		m	5				5				5				
		Branch pipe			10				10				10				
		Total piping length			45				45				45				
	Indoor unit fan notch			-	Hi				Hi				Hi				
	Refrigerant volume			kg	11.0				13.9				13.9				
Outdoor unit	Total current		A	10.0/9.2				12.8/11.7				15.3/14.0					
	Volts		V	380/415				380/415				380/415					
	Compressor frequency		Hz	87				81				88					
LEV opening	Indoor unit		Pulse	259	455	373	194	332	259	455	194	406	280	455	254		
	SC (LEV1)			-				-				-					
Pressure	High pressure(after O/S) /Low pressure(before accumulator)		MPa	2.82/0.67				2.70/0.65				2.70/0.65					
Sectional temp.	Outdoor unit	Discharge (TH11)		°C	79				76				76				
		Heat exchanger outlet (TH5)			1				1				1				
		Accumulator	Inlet		0				0				0				
			Outlet		0				0				0				
		Suction (Compressor)			12				1				2				
		Shell bottom (Compressor)			73				23				27				
	Indoor unit	LEV inlet			38				35				35				
		Heat exchanger outlet			74				72				72				

Items		Outdoor unit		PUHY-P350				PUHY-P400				PUHY-P450					
Condition	Ambient temp.	Indoor	DB/WB	20.0/-				20.0/-				20.0/-					
		Outdoor		7.0/6.0				7.0/6.0				7.0/6.0					
	Indoor unit	Quantity		Set	4				4				4				
		Quantity in operation			4				4				4				
		Model		-	140	125	63	32	200	100	63	32	200	125	80	50	
	Piping	Main pipe		m	5				5				5				
		Branch pipe			10				10				10				
		Total piping length			45				45				45				
	Indoor unit fan notch			-	Hi				Hi				Hi				
	Refrigerant volume			kg	14.7				18.2				21.6				
Outdoor unit	Total current		A	18.6/17.0				20.9/19.2				23.3/21.4					
	Volts		V	380/415				380/415				380/415					
	Compressor frequency (No.1/No.2)		Hz	96				103				50Hz : 83/50 60Hz : 73/60					
LEV opening	Indoor unit		Pulse	441	406	455	254	332	332	455	254	332	406	280	373		
	SC (LEV1)			-				-				-					
Pressure	High pressure(after O/S) /Low pressure(before accumulator)		MPa	2.71/0.67				2.43/0.68				2.83/0.69					
Sectional temp.	Outdoor unit	Discharge (TH11/TH12)		°C	76				71				75/78				
		Heat exchanger outlet (TH5)			2				2				4				
		Accumulator	Inlet		-1				0				1				
			Outlet		-1				0				1				
		Suction (Compressor)			0				-1				1/1				
		Shell bottom (Compressor)			31				30				23/27				
	Indoor unit	LEV inlet			35				31				38				
		Heat exchanger outlet			72				67				71				

Items		Outdoor unit		PUHY-P500				PUHY-P550					
Condition	Ambient temp.	Indoor	DB/WB	20.0/-				20.0/-					
		Outdoor		7.0/6.0				7.0/6.0					
	Indoor unit	Quantity		Set	4				4				
		Quantity in operation			4				4				
		Model		-	250	125	100	32	250	140	125	50	
	Piping	Main pipe		m	5				5				
		Branch pipe			10				10				
		Total piping length			45				45				
	Indoor unit fan notch			-	Hi				Hi				
	Refrigerant volume			kg	22.1				28.1				
Outdoor unit	Total current		A	26.8/24.5				27.6/25.3					
	Volts		V	380/415				380/415					
	Compressor frequency (No.1/No.2)		Hz	50Hz : 102/50 60Hz : 84/60				50Hz : 99/50 60Hz : 93/60					
LEV opening	Indoor unit		Pulse	400	406	332	254	400	384	406	373		
	SC (LEV1)			-				-					
Pressure	High pressure(after O/S) /Low pressure(before accumulator)		MPa	2.89/0.68				2.83/0.69					
Sectional temp.	Outdoor unit	Discharge (TH11/TH12)		°C	76/81				76/79				
		Heat exchanger outlet (TH5)			4				4				
		Accumulator	Inlet		1				1				
			Outlet		1				1				
		Suction (Compressor)			1/1				1/1				
		Shell bottom (Compressor)			24/27				26/29				
	Indoor unit	LEV inlet			39				38				
		Heat exchanger outlet			72				72				

Items		Outdoor unit		PUHY-P600					PUHY-P650					
Condition	Ambient temp.	Indoor	DB/WB	20.0/-					20.0/-					
		Outdoor		7.0/6.0					7.0/6.0					
	Indoor unit	Quantity	Set	5					5					
		Quantity in operation		5					5					
		Model	-	200	200	125	50	25	250	200	125	50	25	
	Piping	Main pipe	m	5					5					
		Branch pipe		10					10					
		Total piping length		55					55					
	Indoor unit fan notch		-	Hi					Hi					
	Refrigerant volume		kg	28.3					29.3					
Outdoor unit	Total current		A	29.9/27.4					33.4/30.6					
	Volts		V	380/415					380/415					
	Compressor frequency (No.1/No.2)		Hz	50Hz : 109/50 60Hz : 105/60					50Hz : 115/50 60Hz : 113/60					
LEV opening	Indoor unit		Pulse	332	332	406	373	229	400	332	406	373	229	
	SC (LEV1)			-					-					
Pressure	High pressure(after O/S) /Low pressure(before accumulator)		MPa	2.85/0.66					2.86/0.63					
Sectional temp.	Outdoor unit	Discharge (TH11/TH12)		°C	79/82					83/85				
		Heat exchanger outlet (TH5)			3					1				
		Accumulator	Inlet		0					-1				
			Outlet		0					-1				
		Suction (Compressor)			-1/-1					-2/-2				
		Shell bottom (Compressor)			26/29					29/31				
	Indoor unit	LEV inlet			38					38				
		Heat exchanger outlet			74					77				



## 9 Troubleshooting

### [1] Check Code List

#### 1. Check Code List

Check code		Check content
0403 (Note1)	[01]	Serial transmission abnormality
	[05]	
0900		Test run (LC)
1102		Discharge temperature abnormality
1301		Low pressure abnormality (OC)
1302		High pressure abnormality (OC)
1500		Overcharged refrigerant abnormality
2500		Leakage (water) abnormality
2502		Drain pump abnormality
2503		Drain sensor abnormality
2600		Water leakage (LC)
2601		Water-supply cut (LC)
4103		Reverse phase abnormality
4108		Over-current protection ( [ P450-P650 model ] No.2 Comp)
4115		Power supply sync signal abnormality
4116		Fan speed abnormality (motor abnormality) (IC, LC)
4121		Harmonic control device abnormality
4220	[108]	Bus Voltage drop abnormality (S/W detect)
4225 (Note1)	[109]	Bus Voltage rise abnormality (S/W detect)
	[110]	Bus Voltage abnormality (H/W detect)
	[111]	Logic error
4230 4235 (Note1)		Heat sink overheat protection
4240 4245 (Note1)		Overload protection
4250	[101]	IPM abnormality
4255 (Note1)	[102]	ACCT overcurrent abnormality (H/W peak detect)
	[103]	DCCT overcurrent abnormality (H/W peak detect)
	[104]	IPM short/grounding abnormality
	[105]	Load short abnormality
	[106]	ACCT overcurrent abnormality (S/W detect peak current)
	[107]	ACCT overcurrent abnormality (S/W detect effective current)
4260 4265 (Note1)		Cooling fan abnormality
5101	Thermal sensor abnormality	Air inlet (TH21:IC)
5102		Open-air treatment inlet (TH4:LC)
		Discharge (TH11, TH12:OC)
5103		Liquid pipe (TH22:IC)
		Open-air treatment pipe (TH2:LC)
5104		Gas pipe (TH23:IC)
		Open-air treatment gas pipe (TH3:LC)
5105		Open-air treatment open air (TH11)
		Open-air temperature (TH24)
5106		Liquid pipe (TH5)
5107		Ambient temperature (TH6)
5108		SC coil outlet (TH7)
5110 (Note1)		SC coil bypass outlet (TH8)
		Heat sink (THHS)
5201		High pressure sensor abnormality (OC)

Check code	Check content
5301	[115] ACCT sensor abnormality
5305	[116] DCCT sensor abnormality
(Note1)	[117] ACCT sensor/circuit abnormality
	[118] DCCT sensor/circuit abnormality
	[119] IPM-open/ACCT connection abnormality
	[120] ACCT miss-wiring abnormality
6600	Multiple address abnormality
6601	Unset polarity
6602	Transmission processor hardware abnormality
6603	Transmission circuit bus-busy abnormality
6606	Communications with transmission processor abnormality
6607	No ACK abnormality
6608	No response abnormality
6831	MA Communication no reception error
6832	MA Communication synchronization recovery error
6833	MA Communication transmission/reception hardware error
6834	MA Communication start bit error
7100	Total capacity abnormality
7101	Capacity code abnormality
7102	Error in the number of connected units
7105	Address setting abnormality
7106	Characteristics setting abnormality (LC)
7110	Connection number setting abnormality
7111	Remote control sensor abnormality
7113	Functional restriction error
7116	System error before flashing operation
7117	Unset model error
7130	Different unit model error

(Note1) Compressor inverter and fan inverter are installed in these R410A series. When checking the check code or the 2-digit detail code, refer to the last digit to confirm whether the error code is for the compressor or for the fan.

Example) Code 4225 → Bus voltage drop Error for fan inverter system  
Code 4250 → IPM / bus voltage fault Error for compressor inverter system

The last digit	Inverter address (system)	Potential model
0 or 1	1	Compressor inverter system
5	5	Fan inverter system

## 2. Intermittent fault check code (only for outdoor unit)

Preliminary error code		Preliminary error content
1202 (1102)		Preliminary discharge temperature abnormality or preliminary discharge thermal sensor abnormality (TH11)
1205 (5105)		Preliminary liquid pipe temperature sensor abnormality (TH5)
1214 (5110) (Note1)	[00]	Preliminary THHS sensor/circuit abnormality
	[05]	
1216 (5107)		Preliminary sub-cool coil outlet thermal sensor abnormality (TH7)
1217 (5108)		Preliminary sub-cool coil bypass outlet thermal sensor abnormality (TH8)
1221 (5106)		Preliminary ambient temperature thermal sensor abnormality (TH6)
1402 (1302)		Preliminary high pressure abnormality or preliminary pressure sensor abnormality
1600 (1500)		Preliminary overcharged refrigerant abnormality
1605		Preliminary suction pressure abnormalit
4158 (4108)		Over-current protection ( [ P450-P650 model ] No.2 Comp)
4171 (4121)		Harmonic control device abnormality
4300 (0403) (Note1)	[01]	Preliminary serial transmission abnormality
	[05]	
4300 (5301)		Preliminary ACCT sensor abnormality
4305 (5305) (Note1)	[116]	Preliminary DCCT sensor abnormality
	[117]	Preliminary ACCT sensor/circuit abnormality
	[118]	Preliminary DCCT sensor/circuit abnormality
	[119]	Preliminary IPM-open/ACCT connection abnormality
	[120]	Preliminary ACCT miss-wiring abnormality
4320 (4220)		[108] Preliminary bus voltage drop abnormality (S/W detect)
4325 (4225) (Note1)	[109]	Preliminary bus voltage rise abnormality (S/W detect)
	[110]	Preliminary bus voltage abnormality (H/W detect)
	[111]	Preliminary logic circuit for H/W error detect abnormality
4330 (4230) 4335 (4235) (Note1)		Preliminary heat sink overheating abnormality
4340 (4240) 4345 (4245) (Note1)		Preliminary overload abnormality
4350 (4250)		[101] Preliminary IPM abnormality
4355 (4255)	[102]	Preliminary ACCT overcurrent abnormality (H/W peak detect)
	[103]	Preliminary DCCT overcurrent abnormality (H/W peak detect)
	[104]	Preliminary IPM short/grounding abnormality
	[105]	Preliminary load short abnormality
	[106]	Preliminary ACCT overcurrent abnormality (S/W detect peak current)
	[107]	Preliminary ACCT overcurrent abnormality (S/W detect effective current)

※ Please refer to ( ) check code. [ ] : Error code No.

(Note1) Compressor inverter and fan inverter are installed in these R410A series. When checking the check code or the 2-digit detail code, refer to the last digit to confirm whether the error code is for the compressor or for the fan.

Example) Code 4225 → Bus voltage drop Error for fan inverter system  
Code 4250 → IPM / bus voltage fault Error for compressor inverter system

The last digit	Inverter address (system)	Potential model
0 or 1	1	Compressor inverter system
5	5	Fan inverter system

## [2] Responding to Error Display on the Remote Controller

### 1. Mechanical problems

Checking code		Meaning, detecting method	Cause	Checking method & Countermeasure
0403	Serial transmission abnormality	Serial transmission failure between the main board and the INV board, and between the main board and the FAN board. Detail code 01: Between the main board and the INV board Detail code 05: Between the main board and the FAN board	(1) Defective wiring.	Check for wiring between the main board connector CNRS3B and the INV board connector CNRS1 or between the main board connector CNRS3A and the FAN board connector CNRS2 or check for contact the connector. Check for contact of the connector CNAC3 on the main board or of the connector CNTR on the FAN board.
			(2) Inverter address switches are set wrong.	Check the address of SW2-1 on the INV board. Check SW2-1 on the FAN board whether it is ON.
			(3) Transformer failure.	Measure voltages between pins 1 and 3 of the FAN board connector CNTR.
			(4) Defective INV board. Defective FAN board.	Replace the INV board or the FAN board when the power turns on automatically, even if the power is reset.
1102	Discharge temperature abnormality (Outdoor unit)	1. When 120°C or more discharge temperature is detected during operations (the first time), outdoor unit stops once, mode is changed to restart mode after 3 minutes, then the outdoor unit restarts.  2. When 120 °C or higher discharge is detected again (the second time) within 30 minutes after the first stop of outdoor unit, mode is changed to restart mode after 3 minutes, then the outdoor unit restarts.  3. When 120°C or more discharge is detected, again (the third time) within 30 minutes after previous stop of outdoor unit, emergency stop is observed with code No.“1102” displayed.  4. When 120°C or more discharge is detected 30 or more minutes after previous stop of outdoor unit, the stop is regarded as the first time and the process shown in 1. is observed.  5. 30 minutes after stop of outdoor unit is intermittent fault check period with LED displayed.	(1) Gas leak, gas shortage.	See <b>Refrigerant amount check.</b>
			(2) Overload operations.	Check operating conditions and operation status of indoor/outdoor units.
			(3) Poor operations of indoor LEV. (4) Poor operations of OC controller LEV1.	Check operation status by actually performing cooling or heating operations. Cooling : Indoor LEV (Cooling-only) LEV1  Heating : Indoor LEV (Heating-only)  See <b>Trouble check of LEV and solenoid valve.</b>
			(5) Poor operations of ball valve.	Confirm that ball valve is fully opened.
			(6) Outdoor unit fan block, motor trouble, poor operations of fan controller Heating (Heating-only, Heating-main). { (3) ~ (6) : Rise in discharge temp. by low pressure drawing. }	Check outdoor fan. See <b>Trouble check of outdoor fan.</b>
			(7) Gas leak between low and high pressures. { 4-way valve trouble, compressor trouble, solenoid valve SV1 trouble. }	Check operation status of cooling-only or heating-only.
			(8) Thermistor trouble (TH11, TH12).	Check resistance of thermistor.
			(9) Thermistor input circuit trouble on control circuit board.	Check inlet temperature of sensor with LED monitor.

\* For the check code on the inverter, refer to “ 6. Inverter and compressor ” in the section [4] “ Troubleshooting of principal parts ”

Checking code		Meaning, detecting method	Cause	Checking method & Countermeasure
1301	Low pressure abnormality	When starting the compressor from Stop Mode for the first time (include the time when starting the compressor for the next time, when starting bound power, ending bound power or when the thermo turns off just after the remote controller is turned on), check the low-pressure sensor beforehand. If the sensor is 0.098MPa, stop the operation immediately after starting.	(1) Internal pressure is dropping due to a gas leak. (2) The low pressure pressure sensor is defective. (3) Insulation is torn. (4) A pin is missing in the connector, or there is faulty contact. (5) A wire is disconnected. (6) The control board's low pressure pressure sensor input circuit is defective.	Refer to the item on judging low pressure pressure sensor failure.
1302	High pressure abnormality 1 (Outdoor unit)	<p>1. When pressure sensor detects 3.87MPa or more during operations (the first time), outdoor unit stops once, mode is changed to restart mode after 3 minutes, then the outdoor unit restarts.</p> <p>2. When a pressure of 3.87MPa or more is detected again (the second time) within 30 minutes after first stop of outdoor unit, mode is changed to restart mode after 3 minutes, then the outdoor unit restarts.</p> <p>3. When 3.87MPa or more pressure is detected again (the third time) within 30 minutes after stop of outdoor unit, error stop is observed with code No. "1302" displayed.</p> <p>4. When 3.87MPa or more pressure is detected 30 or more minutes after stop of outdoor unit, the detection is regarded as the first time and the process shown in 1. is observed.</p> <p>5. 30 minutes after stop of outdoor unit is intermittent fault check period with LED displayed.</p> <p>6. Error stop is observed immediately when pressure switch (4.15<sup>+0.5</sup> MPa) operates in addition to pressure sensor.</p>	(1) Poor operations of indoor LEV → Heating	Check operations status by actually performing cooling or heating operations. Heating : Indoor LEV  <b>See Trouble check of LEV and solenoid valve.</b>
			(2) Poor operations of ball valve.	Confirm that ball valve is fully opened.
			(3) Short cycle of indoor unit. (4) Clogging of indoor unit filter. (5) Fall in air volume caused by dust on indoor unit fan. (6) Dust on indoor unit heat exchanger. (7) Indoor unit fan block, motor trouble. (2)-(7) : Rise in high pressure caused by lowered condensing capacity in heating-only and heating-main operation.	Check indoor unit and take measures to trouble.
			(8) Short cycle of outdoor unit. (9) Dust on outdoor unit heat exchanger.	Check outdoor unit and take measures to trouble.
			(10) Outdoor unit fan block, motor trouble, poor operations of fan controller. (8)-(10) : Rise in high pressure caused by lowered condensing capacity in cooling-only and cooling-main operation.	Check outdoor unit fan <b>See Trouble check of outdoor unit fan.</b>
			(11) Poor operations of solenoid valves SV1 (Bypass valves (SV1) can not control rise in high pressure).	<b>See Trouble check of solenoid valve.</b>
			(12) Thermistor trouble (TH5, TH6).	Check resistance of thermistor.
			(13) Pressure sensor trouble.	<b>Check Trouble check of pressure sensor.</b>
			(14) Control circuit board thermistor trouble, pressure sensor input circuit trouble.	Check inlet temperature and pressure of sensor with LED monitor.
			(15) Thermistor mounting failure (TH5, TH6) (16) No connector for pressure switch (63H), disconnected wire.	Check inlet temperature and pressure of sensor with LED monitor.
			(17) Fuse melting on the control board (F01 or F02).	Check whether the fuse melts. Check whether the actuator for the cooling FAN (MF), the 4-way valve or the solenoid valve is not short-circuited and broken.

Checking code		Meaning, detecting method	Cause	Checking method & Countermeasure
1302	High pressure abnormality 2 (Outdoor unit)	When pressure sensor detects 0.098MPa or less just before starting of operation, error stop is observed with code No. "1302" displayed.	(1) Fall in internal pressure caused by gas leak. (2) Pressure sensor trouble. (3) Film breakage. (4) Coming off of pin in connector portion, poor contact. (5) Broken wire. (6) Pressure sensor input circuit trouble on control circuit board.	See <b>Trouble check of pressure sensor</b> .
1500	Overcharged refrigerant abnormality	<p>1. If the discharge SH <math>\leq</math> 10K is detected during operation (at first detection), the outdoor unit stops at once. The 3 minutes restart prevention mode is entered. After three minutes, the outdoor unit starts up again.</p> <p>2. If the discharge SH <math>\leq</math> 10K is detected again within 30 minutes after the outdoor unit stops (second detection), an abnormal stop is applied, and "1500" is displayed.</p> <p>3. If discharge SH <math>\leq</math> 10K is detected more than 30 minutes after the outdoor unit stops, the state is the same as the first detection and the same operation as 1. above takes place.</p> <p>4. The abnormal stop delay period is in effect for 30 minutes after the outdoor unit stops. The abnormal stop delay period LED turns ON during this time.</p>	(1) Excessive refrigerant charge.	Refer to the section on judging the refrigerant volume.
			(2) Main circuit board thermistor input circuit trouble. (3) Thermistor mounting trouble (TH11, TH12).	Check the sensor detection temperature and pressure with the LED monitor.
2500	Leakage (water) abnormality	When drain sensor detects flooding during drain pump OFF.	(1) Water leak due to humidifier or the like in trouble.	Check water leaking of humidifier and clogging of drain pan.

Checking code		Meaning, detecting method	Cause	Checking method & Countermeasure
2502	Drain pump abnormality (This error occurs only for the applied indoor units.)	When drain sensor detects flooding during drain pump ON.	<p>(1) Drain pump malfunction</p> <p>(2) Clogged drain pump intake</p> <p>(3) Clogged drain pipe</p> <p>(4) Return water from drain pipe (installation defect)</p>	<p>(1) Check the drain pump malfunction</p> <p>①<b>Check whether there is water in the drain pan.</b> When the water level is approximately 10mm from the bottom of the drain pan, the drain pump may be normal.</p> <p>②<b>Check whether the drain pump operates properly.</b> Whether the resistance of the drain pump is normal or the drain pump operates when the power supply is applied.</p> <p>(2) Check the clogged drain pump intake. Check whether there is no dust around the drain pump intake.</p> <p>(3) Check the clogged drain pipe. Check whether there is no clogging outside of the pipe body.</p> <p>(4) Check the return water. Pour approximately 1-liter water in the drain pump, and start the drain pump. When the water level in the drain pan becomes stably lower, stop the pump, and check the amount of the return water to the drain pan. ※When a large amount of water returns, the gradient of drain pipe may be the reason. Check whether the drain pipe is installed properly as the instruction in the installation manual says. Furthermore, check whether the gradient of the unit installation is horizontal. Error may be detected because of the return water depending on the gradient. (Gradient approximately 0.5°)</p> <p>After checking the above, when all normal, misdetection of the drain sensor is possible.</p> <p>①Check the drain sensor. · Check the resistance value.</p> <p>&lt;Error release method&gt; Reset (error reset) the applied indoor unit with the remote controller.</p>

Checking code		Meaning, detecting method	Cause	Checking method & Countermeasure
2502	Drain pump abnormality (This error occurs for all the indoor units in the same refrigerant system.)	When drain sensor detects flooding during drain pump ON in the stopped indoor unit.	(1) Drain pump malfunction (2) Clogged drain pump intake (3) Clogged drain pipe (4) Return water from drain pipe (installation defect)	Refer to the previous page.  <Error release method> Reset the power of the applied indoor unit. However, the reset (error reset) using the remote controller can be done in 10 minutes after the power has been reset. Furthermore, the reset using the remote controller is required for all the indoor units.
2503	Drain sensor abnormality	When short circuit or open circuit is detected during operation (cannot be detected during OFF). Short circuit: detected 90°C or more Open circuit: detected -20°C or less	(1) Thermistor failure (2) Connector contact failure (Insert failure) (3) Disconnected wire or partial disconnected wire for thermistor	Thermistor resistance check 0°C : 6.0kΩ 10°C : 3.9kΩ 20°C : 2.6kΩ 30°C : 1.8kΩ 40°C : 1.3kΩ
			(4) Indoor board (detection circuit) failure	Connector contact failure If no fault is found, indoor board is faulty.
2600	Water leakage	-	Water leaks from the pipes in such as the humidifier.	Check the place from where the water leaks.
2601	Water-supply cut	-	(1) Water is not supplied into the humidification feed tank.	Check the amount of supply water. Check the solenoid valve or connection.
			(2) The solenoid valve for humidification is OFF.	Check the connector.
			(3) Float switch disconnection.	Check the connecting part.
			(4) Float switch malfunction.	Check the defective float switch.
			(5) Freeze on the feed tank.	Defrost by turning the power off and turn the power on again.



Checking code		Meaning, detecting method	Cause	Checking method & Countermeasure								
4103	Reverse phase abnormality	1. The operation cannot be started because of the reverse phase of one of the power lines (L1, L2 or L3).	(1) Faulty wiring	<ul style="list-style-type: none"> <li>Check whether the phase of the power supply terminal block (TB1) is normal.</li> <li>Check the wiring between the power supply terminal block (TB1) and the main boards (CN20 and CN21).</li> </ul> <table border="1"> <thead> <tr> <th>TB1</th> <th>Pin</th> </tr> </thead> <tbody> <tr> <td>L1</td> <td>CN20 5 Pin</td> </tr> <tr> <td>N</td> <td>CN21 3 Pin</td> </tr> <tr> <td>L2</td> <td>CN21 1 Pin</td> </tr> </tbody> </table>	TB1	Pin	L1	CN20 5 Pin	N	CN21 3 Pin	L2	CN21 1 Pin
			TB1	Pin								
		L1	CN20 5 Pin									
		N	CN21 3 Pin									
		L2	CN21 1 Pin									
		(2) Main board failure	If the above faults are not found, the main board is faulty.									
		2. When turning on the power, the operation cannot be started because of the open phase of one of the power lines (L1 or L2).	(1) Power supply failure <ul style="list-style-type: none"> <li>a) Open phase of power supply voltage</li> <li>b) Power supply voltage drop</li> </ul>	Check the input resistance of the power supply terminal block (TB1).								
			(2) Faulty wiring Between the power supply terminal block (TB1) and the main boards (CN20 and 21)	<ul style="list-style-type: none"> <li>Check the voltage of No.5 pin of the main board connector (CN20) and the voltage between No.1 and 3 pin of CN21.</li> <li>If the voltage is not the same as the power supply voltage, the wiring is faulty.</li> </ul>								
(3) Blown fuse	Check whether the fuses of the main board (both F01 and F02) are not blown.											
(4) Main board failure	If the above faults are not found, the main board is faulty.											
4108	Over-current protection	<p>1. First detection If 51C2 is started during the operation of No.2 compressor, the outdoor unit stops once, turns to anti-restart mode for 3 minutes, and restarts after 3 minutes. (Set value of the over-current relay: 55A)</p> <p>2. Second detection If 51C2 is started again within a minute after restarting in compliance with 1. above, the unit makes an error stop and the error code "4108" will appear.</p> <p>3. There will be a minute grace period of an error stop when No.2 compressor restarts after the outdoor unit stops and LED indicates, which means the grace period, will appear.</p>	(1) Overload operation that exceeds unit use limit	Check the unit working condition.								
			(2) Power supply error <ul style="list-style-type: none"> <li>a) Power-supply voltage drop</li> <li>b) Power-supply voltage open phase</li> </ul>	Check the voltage of the power-supply terminal block (TB1). Check for open phase.								
			(3) Wiring defect	Check 52C2 connector and the wiring.								
			(4) Compressor malfunction <ul style="list-style-type: none"> <li>a) Compressor open phase, grounding fault</li> <li>b) Compressor lock</li> </ul>	Check the wiring and apply a megger to the compressor. Start operation under no-load conditions. Remove the power wire on the compressor-side, insulate the power line and start operation. → The compressor is faulty if 52C2 normally turns on.								

Checking code		Meaning, detecting method	Cause	Checking method & Countermeasure
4115	Power supply sync signal abnormality	The frequency cannot be determined when the power is switched on. (The power supply's frequency cannot be detected. The outdoor fan cannot be controlled by phase control.)	(1) There is an open phase in the power supply.	Check before the breaker, after the breaker or at the power supply terminal blocks TB1, and if there is an open phase, correct the connections.
			(2) A fuse is defective.	If F01 or F02 on the MAIN board is melted, (Resistance between both ends of the fuse is $\infty$ ), replace the fuses.
			(3) Faulty wiring.	Check voltage between the pin-5 on the main board connector (CN20), between the pin-1 and the pin-3 on CN21. When the voltage is not the same as the power source voltage (380-415V), the wiring is faulty.
			(4) The circuit board is defective.	If none of the items in (1) to (3) is applicable, and if the trouble reappears even after the power is switched on again, replace the MAIN board (when replacing the circuit board, be sure to connect all the connectors, ground wires, etc. securely).
4116	Fan speed abnormality (motor abnormality)	[ LOSSNAY ] 1. The motor keep running even if the power is OFF. 2. The thermal overload relay is ON. (Only for the three-phase model) [ Indoor unit ] If detected less than 180rpm or more than 2000rpm, the indoor unit will restart and keep running for 3 minutes. If detected again, the display will appear.	(1) Defective board.	Replace the board.
			(2) Motor malfunction.	Check for the motor and the solenoid switch.
			(3) Solenoid switch malfunction.	
4220 4225	Bus voltage drop abnormality (Error details No.108)	If $V_{dc} \leq 289V$ is detected during operation. (Software detection)	(1) Power environment.	Check whether the unit makes an instantaneous stop when the detection result is abnormal or a power failure occurs. Check whether the power voltage $\geq 342V$ across all phases.
			(2) Voltage drop detected.	<b>&lt;In the case of 4220&gt;</b> Check the voltage of the connector (CNDC2) on the INV board. → Replace the INV board when there is no voltage drop. → Check the followings when there is a voltage drop. ① Check the voltage of CN52C on the main board → Refer to (3) ② Check whether 52C1 works normally → Refer to (4) Or check 52C1-connecting piping. ③ Check for the diode stack → Refer to (5) ④ Check for the wiring and the connectors between the CNDC2 on the INV board and the CNDC1 on the G/A board. Replace G/A board when no fault is found for the above ①~④.

Checking code		Meaning, detecting method	Cause	Checking method & Countermeasure
4220 4225	Bus voltage drop abnormality (Error details No.108)	If Vdc $\leq$ 289V is detected during operation. (Software detection)	(2) Voltage drop detected.	<p><b>&lt;In the case of 4225&gt;</b>  Check the followings  ①Check the voltage of CN52C on the main board  → Refer to (3).  ②Check whether 52C1 works normally → Refer to (4)  Or check 52C1-connecting piping.  ③Check for the diode stack  → Refer to (5)  ④Check for the wiring and the connectors of the CNVDC on the FAN board.  Replace FAN board when no fault is found for the above ①~④.</p>
			(3) Main board failure.	Check whether AC220~240V is applied to the connector (CN52C) during inverter operation. → If not applied, check the main board and the fuse (F01 and F02). Replace the main board when no fault is found.
			(4) 52C1 failure.	Refer to [9].[4].6.(2) Check the coil resistance check.
			(5) Diode stack failure.	Refer to [9].[4].6.(2) Check the diode stack resistance.
Bus voltage rise abnormality (Error details No.109)	If Vdc $\geq$ 817V is detected during inverter operation.	(1) Different voltage connection.	Check the voltage of the power-supply terminal block (TB1).	
		(2) INV board failure.	Replace INV board if no fault is found. In the case of 4220: INV board In the case of 4225: FAN board	
Bus Voltage abnormality (Error details No.110)	Bus voltage abnormality If Vdc $\geq$ 772V or Vdc $\leq$ 308V is detected. (H/W detection)	(1) Same as detail code No.108 and 109 of 4220 error.	Same as detail code No.108 and 109 of 4220 error.	
Logic error (Error details No.111)	If only the H/W error logic circuit operates, and no identifiable error is detected.	<b>&lt;In the case of 4220&gt;</b> (1) External noise. (2) INV board failure. (3) G/A board failure. (4) IPM failure. (5) DCC failure.	Refer to [9].[4].6.(2).[5] Replace G/A board. Refer to [9].[4].6.(2).[1] Replace DCCT.	
		<b>&lt;In the case of 4225&gt;</b> (1) External noise. (2) FAN board failure.	Refer to [9].[4].6.(2).[7]	
4230 4235	Heat sink overheat protection	<b>&lt;In the case of 4230&gt;</b> When the heat sink temperature (THHS1) $\geq$ 95°C is detected.	(1) Power supply environment.	Check the power supply voltage. Ensure that the power supply voltage $\geq$ 342V across all phases.
		<b>&lt;In the case of 4235&gt;</b> When the heat sink temperature (THHS5) $\geq$ 85°C is detected.	(2) Air passage blockage.	Check to make sure the air passage of the heat sink cooling is not blocked.
		(3) Wiring defect.	Check the cooling fan wiring.	
		(4) THHS failure.	Check the THHS sensor resistance.	
		(5) INV board fan output failure.	Ensure that the heat sink temperature is 55°C or more and that 220~240V is applied to the inverter PCB connector CNFAN when the inverter is on.	
		(6) Cooling fan failure.	Check the cooling fan operation under the above operating conditions.	
		(7) IPM failure.	Refer to [9].[4].6.(2) "Check for compressor ground fault or coil error" [5] "Check the inverter circuit trouble"	

\* For the check code on the inverter, refer to " 6. Inverter and compressor " in the section [4] " Troubleshooting of principal parts "

Checking code		Meaning, detecting method	Cause	Checking method & Countermeasure	
4240 4245	Overload abnormality	When the output current (Iac) > I <sub>max</sub> (Arms) or THHS > 90°C is detected for 10 minutes in a row during the inverter operation.	(1) Air passage short cycle.	Ensure that a short cycle has not occurred at the unit fan exhaust.	
			(2) Air passage blockage.	Check to make sure the air passage of the heat sink cooling is not blocked.	
			(3) Power supply.	Check if the power supply voltage ≥ 342V.	
			(4) Wiring defect.	Check the cooling fan wiring.	
			(5) THHS failure.	Check the THHS sensor resistance.	
			(6) INV board fan output failure.	Ensure that the heat sink temperature is 55°C or more and that 220~240V is applied to the inverter PCB connector CNFAN when the inverter is on.	
			(7) Cooling fan failure.	Check the cooling fan operation under the above operating conditions.	
			(8) Current sensor (ACCT) failure.	Refer to [9].[4].6.(4) "Current sensor ACCT"	
			(9) Inverter circuit failure.	Refer to [9].[4].6.(2).[4] "Inverter damage check"	
			(10) Compressor failure.	Check that the compressor has not overheated during operation. → Check the refrigerant circuit (oil return section). Replace the compressor if there are no problems with the refrigerant circuit.	
4250 4255	IPM abnormality (Error details No.101)	IPM error signal detected	<In the case of 4250> (1) Inverter output related. (2) Same as 4230 error.	Same as 4230 error	
			<In the case of 4255> (1) Grounding fault of fan motor. (2) FAN board failure.	Refer to [9].[4].6.(2).[6] Refer to [9].[4].6.(2).[7]	
	ACCT overcurrent abnormality (Error details No.102) DCCT overcurrent abnormality (Error details No.103) ACCT overcurrent abnormality (Error details No.106, 107)	Overcurrent break (94A <sub>peak</sub> or 35Arms) detected by the current sensor.	(1) Inverter output related.		[9].[4].6.(2) inverter output related trouble processing Refer to [1] - [5].
					IPM short/grounding fault (Error details No.104)
<In the case of 4255> (1) Grounding fault of fan motor. (2) FAN board failure.	Refer to [9].[4].6.(2).[6] Refer to [9].[4].6.(2).[7]				

\* For the check code on the inverter, refer to "6. Inverter and compressor" in the section [4] "Troubleshooting of principal parts"

Checking code		Meaning, detecting method	Cause	Checking method & Countermeasure
4250 4255	Load short abnormality (Error details 105)	Shorting at the load (compressor) side detected just before starting the inverter.	<In the case of 4250> (1) Shorting of compressor (2) Output wiring (3) Power supply	Refer to [9].[4].6.(2).[2]
			<In the case of 4255> (1) Shorting of fan motor (2) Output wiring (3) Power supply	Refer to [9].[4].6.(2).[6]
4260 4265	Cooling fan abnormality	<In the case of 4260> When the heat sink temperature (THHS1) $\geq 95^{\circ}\text{C}$ for 10 minutes or longer after the inverter starts.  <In the case of 4265> When the heat sink temperature (THHS5) $\geq 85^{\circ}\text{C}$ for 10 minutes or longer after the inverter starts.	Same as 4230 error	Same as 4230 error
5101	Thermal sensor error (Indoor unit)	Air inlet	(1) Thermistor failure (2) Contact failure of the connector (3) Thermistor wire disconnection or partial disconnection (4) Thermosensor is not set up or contact failure  (5) Indoor board failure (detection circuit)	Thermistor resistance check 0°C : 15k $\Omega$ 10°C : 9.7k $\Omega$ 20°C : 6.4k $\Omega$ 30°C : 4.3k $\Omega$ 40°C : 3.1k $\Omega$
5102		Liquid pipe		
5103		Gas pipe		
5104		Outdoor air temperature		
5104	(Outdoor air processing unit)	Outdoor air temperature	(1) The connection of the connector (CN29) is a failure. (2) The outdoor air processing unit is out of order.	Check the contact of the connector  Replace the sensor.

\* For the check code on the inverter, refer to “ 6. Inverter and compressor ” in the section [4] “ Troubleshooting of principal parts ”

Checking code		Meaning, detecting method	Cause	Checking method & Countermeasure
5101	Discharge (TH11) (TH12)	1. Shorting (high temperature intake) or open (low temperature intake) of the thermistor is detected. (First detection) The outdoor unit will stop at once and the restart prevention mode will be operated for 3 minutes. When the detection temperature of the thermistor is within the normal range just before the restart, the unit must be restarted.	(1) Thermistor failure	Thermistor resistance check
			(2) Pinched lead wire	Check for lead wire.
			(3) Coating tear	Check for coating.
			(4) No pin on the connector, contact failure	Check for connector.
			(5) Disconnected wire	Check for wire.
			(6) Thermistor input circuit failure on the main board	Check the intake temperature of the sensor with the LED monitor. When the temperature is far different from the actual temperature, replace the control board.
5105	Piping (TH5)	2. When shorting or open is detected again (second detection) during the operation after the restart, the outdoor unit will stop at once and the restart prevention mode will be operated for 3 minutes. When the detection temperature of the thermistor is within the normal range just before the restart, the unit must be restarted.	Shorting detection TH11 240°C or higher (0.57kΩ) TH12 240°C or higher (0.57kΩ) TH5 110°C or higher (0.4kΩ) TH6 110°C or higher (0.4kΩ) TH7 70°C or higher (1.14kΩ) TH8 70°C or higher (0.4kΩ)	Open detection 0°C or lower (643kΩ) 0°C or lower (643kΩ) -40°C or lower (130kΩ) -40°C or lower (130kΩ) -40°C or lower (130kΩ) -40°C or lower (130kΩ)
5106	Outdoor air temperature (TH6)			
5107	Liquid temperature (TH7)			
5108	SC coil outlet (TH8)			
Temperature sensor abnormality (Outdoor unit)				
3. When shorting or open is detected again (third detection) during the operation after the restart, the outdoor unit will make an error stop. 4. When shorting or open of the thermistor is detected just before the restart, the unit will make an error stop and check code "5101", "5103", "5104", "5105", "5106", "5107", and "5108" will appear. 5. LED display, which indicates the grace period, will appear while the restart prevention mode is being operated. 6. Shorting or open is not detected for 10 minutes after starting the compressor or for 3 minutes during or after defrosting.				
5110	Radiator panel temperature sensor abnormality  Error details 01: Compressor INV side  Error details 05: Fan INV side	THHS open or shorting is detected just before starting the inverter or during operation.	(1) THHS sensor failure	Check for short circuit in THHS sensor.
			(2) Contact failure	Replace THHS sensor.
			(3) INV board failure of the compressor or the fan	Replace INV board of the compressor or the fan.

※ For the check code on the inverter, refer to " 6. Inverter and compressor " in the section [4] " Troubleshooting of principal parts "

Checking code		Meaning, detecting method	Cause	Checking method & Countermeasure
5201	High pressure sensor abnormality (outdoor unit)	<p>1. When pressure sensor detects 0.098MPa or less during operation, outdoor unit once stops with 3 minutes restarting mode, and restarts if the detected pressure of pressure sensor exceeds 0.098MPa immediately before restarting.</p> <p>2. If the detected pressure of sensor is less than 0.098MPa immediately before restarting, error stop is commenced displaying 5201.</p> <p>3. Under 3 minutes restarting mode, LED displays intermittent fault check.</p> <p>4. During 3 minutes after compressor start, defrosting and 3 minutes after defrosting operations, trouble detection is ignored.</p>	(1) Pressure sensor trouble.	See <b>Troubleshooting of pressure sensor</b> .
			(2) Inner pressure drop due to a leakage.	
			(3) Broken cover.	
			(4) Coming off of pin at connector portion, poor contact.	
			(5) Broken wire.	
			(6) Faulty thermistor input circuit of MAIN board.	
5301 5305	ACCT sensor abnormality (Error details No.115)	-1.5Arms $\leq$ output current's effective value $\leq$ 1.5Arms was detected during inverter operation.	(1) Contact is faulty.	Check the INV board CNCT2 (ACCT) contact, CNDR2 and G/A Board CNDR1.
			(2) ACCT sensor is faulty.	Replace the ACCT sensor
	DCCT sensor abnormality (Error details No.118) * Other than P200 model	An abnormal value is detected in the DCCT detection circuit just before the INV started.	(1) Contact is faulty.	Check the connector connection on the INV board CNCT (DCCT), DCCT side.
			(2) DCCT sensor incorrectly installed.	Check DCCT installation direction
			(3) DCCT sensor is faulty.	Replace the DCCT sensor
			(4) INV board fault.	Replace the INV board
	ACCT sensor/circuit abnormality (Error details No.117)	An abnormal value was detected with the ACCT detection circuit just before the INV started.	(1) INV board fault.	Refer to [9].[4].6.(2).[1] "Check the INV board error detection circuit"
			(2) Compressor ground fault and IPM fault.	Refer to [9].[4].6.(2).[2] "Check for compressor ground fault or coil error." Refer to [9].[4].6.(2).[5] "Check the inverter circuit trouble".
	DCCT sensor/circuit abnormality (Error details No.116) * Other than P200 model	An abnormal value was detected with the DCCT detection circuit just before the INV started.	(1) Contact is faulty.	Check the contacts around the INV board connector CNCT and DCCT side connector.
			(2) INV board fault.	Refer to [9].[4].6.(2).[1] "Check the INV board error detection circuit".
			(3) DCCT sensor is faulty.	If there is no problem up to step (2), replace DCCT and check the DCCT polarity.
			(4) Compressor ground fault and IPM fault.	Refer to [9].[4].6.(2).[2] "Check for compressor ground fault or coil error." Refer to [9].[4].6.(2).[5] "Check the inverter circuit trouble".

\* For the check code on the inverter, refer to " 6. Inverter and compressor " in the section [4] " Troubleshooting of principal parts "

Checking code		Meaning, detecting method	Cause	Checking method & Countermeasure
5301 5305	IPM- open/ACCT connection abnormality (Error details No.119)	IPM open damage or CNCT2 dislocation was detected just before INV started. (Sufficient current was not detected during self-diagnosis just before starting.)	(1) ACCT sensor is dislocated	Check CNCT2 sensor connection (Check ACCT installation state)
			(2) Wire connection is faulty.	Check CNDR2 connection on INV board, or CNDR1 connection on G/A board
			(3) ACCT is faulty.	Refer to [9].[4].6.(4) “Current sensor ACCT” resistance value
			(4) Compressor is disconnected	Refer to [9].[4].6.(2).[2] “Check for compressor ground fault or coil error”.
			(5) Inverter circuit is faulty.	Refer to [9].[4].6.(2).[5] “Check the inverter circuit trouble”.
ACCT miss-wiring abnormality (Error details No.120)	Improper installation of the ACCT sensor was detected.	(1) ACCT sensor incorrectly installed.	Refer to [9].[4].6.(4) “Current sensor ACCT”.	

※ For the check code on the inverter, refer to “ 6. Inverter and compressor ” in the section [4] “ Troubleshooting of principal parts ”

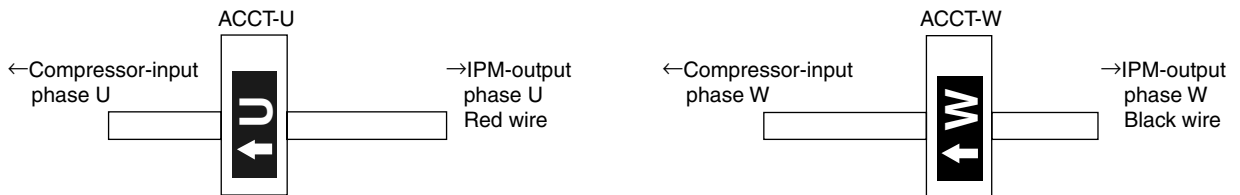

## 2. Communication/system errors

Checking code	Meaning, detecting method	Cause	Checking method & Countermeasure
6600	Multiple address abnormality  Transmission from units with the same address is detected.  <div style="border: 1px solid black; padding: 5px;">Note: The address/attribute shown on remote controller indicates the controller which has detected error.</div>	(1) Two or more controllers of outdoor unit, indoor unit, remote controller, etc. have the same address.  <Example> Error display of the remote controller 6600 “01”  Unit No.1 detected the error Two Units No.1 or more are in a same system.	Search for the unit which has the same address with that of the source of the trouble.  <div style="border: 1px solid black; padding: 5px;">When the same address is found, turn off the power source of outdoor unit, and indoor unit for 5 minutes or more after modifying the address, and then turn on it again.</div>
6601	Unset polarity  The error detected when transmission processor cannot distinguish the polarities of the M-NET transmission line.	(1) No voltage is applied to the M-NET transmission line that G-50A is connected to.  (2) M-NET transmission line to which G-50A is connected is short-circuited.	Check if power is supplied to the M-NET transmission line of the G-50A, and correct any problem found.



Checking code	Meaning, detecting method	Cause	Checking method & Countermeasure
6602	<p>Transmission processor hardware abnormality</p> <p>Though transmission processor intends to transmit "0", "1" is displayed on transmission line.</p> <div data-bbox="359 383 683 544" style="border: 1px solid black; padding: 5px;"> <p>Note: The address/attribute shown on remote controller indicates the controller which has detected error.</p> </div>	<p>(1) At the collision of mutual transmission data generated during the wiring work or polarity change of the transmission line of indoor or outdoor unit while turning the power source on, the wave shape is changed and the error is detected.</p> <p>(2) Ground fault of transmission line.</p> <p>(3) Insertion of power supply connector (CN40) of plural outdoor units at the grouping of plural refrigerant systems.</p> <p>(4) Insertion of power supply connector (CN40) of plural outdoor units in the connection system with MELANS.</p> <p>(5) When using the power supply unit for transmission line in the connected system with MELANS, the power supply connector (CN40) of the outdoor unit is inserted into the transmission line.</p> <p>(6) Faulty controller of unit in trouble.</p> <p>(7) Change of transmission data due to the noise in transmission.</p> <p>(8) Connection system with plural refrigerant systems or MELANS for which voltage is not applied on the transmission line for central control.</p>	<p>Checking method &amp; Countermeasure</p>
6603	<p>Transmission circuit bus-busy abnormality</p> <p>1. Collision of data transmission: Transmission can not be performed for 4~10 consecutive minutes due to collision of data transmission.</p> <p>2. Data can not be transmitted on transmission line due to noise for 4~10 consecutive minutes.</p> <div data-bbox="359 1984 683 2089" style="border: 1px solid black; padding: 5px;"> <p>Note: The address/attribute shown on remote controller indicates the controller which has detected error.</p> </div>	<p>(1) As the voltage of short frequency like noise is mixed in transmission line continuously, transmission processor can not transmit.</p> <p>(2) Faulty controller of generating unit.</p>	<p>(a) Check transmission wave shape/noise on transmission line by following &lt;Investigation method of transmission wave shape/noise&gt;.</p> <p>→No noise indicates faulty controller of generating unit.</p> <p>→Noise if existed, check the noise.</p>

Checking code	Meaning, detecting method	Cause	Checking method & Countermeasure
6606	<p>Communications with transmission processor abnormality</p> <p>Communication trouble between apparatus processor and transmission processor.</p> <div style="border: 1px solid black; padding: 5px; margin-top: 10px;"> <p>Note: The address/attribute shown on remote controller indicates the controller which has detected error.</p> </div>	<p>(1) Data is not properly transmitted due to casual erroneous operation of the generating controller.</p> <p>(2) Faulty generating controller.</p>	<p>Turn off power sources of indoor unit, and outdoor unit.</p> <div style="border: 1px solid black; padding: 5px; margin-top: 10px;"> <p>{ When power sources are turned off separately, microcomputer is not reset and normal operations can not be restored. }</p> </div> <p>→Controller trouble is the source of the trouble when the same trouble is observed again.</p>

Checking code	Meaning, detecting method				
6607	<p>No ACK abnormality</p> <p>When no ACK signal is detected in 6 continuous times with 30 seconds interval by transmission side controller, the transmission side detects error.</p> <div style="border: 1px solid black; padding: 5px; margin-top: 10px;"> <p>Note : The address/attribute shown on remote controller indicates the controller not providing the answer (ACK).</p> </div>				
System composition	Generating unit address	Display of trouble	Detecting method	Cause	Cause checking method & Countermeasure
<b>(1) Single refrigerant system</b>	1. Outdoor unit (OC)	Remote controller (RC)	No reply (ACK) at BC transmission to OC	<p>(1) Poor contact of transmission line of OC or BC.</p> <p>(2) Damping of transmission line voltage/signal by acceptable range of transmission wiring exceeded.</p> <div style="border: 1px solid black; padding: 5px; margin-top: 5px;"> <p>{ Farthest: Less than 200m Remote controller wiring: Less than 10m }</p> </div> <p>(3) Erroneous sizing of transmission line (Not within the range below). Wire diameter: 1.25mm<sup>2</sup> or more</p> <p>(4) Faulty control circuit board of OC.</p>	<p>Shut down OC unit power source, and make it again.</p> <p>It will return to normal state at an accidental case.</p> <p>When normal state can not be recovered, check for the (1) ~ (4) of the cause.</p>
	2. Indoor unit (IC)	Remote controller (RC)	No reply (ACK) at RC transmission to IC	<p>(1) When IC unit address is changed or modified during operation.</p> <p>(2) Faulty or disconnection of transmission wiring of IC.</p> <p>(3) Disconnection of IC unit connector (CN2M).</p> <p>(4) Faulty IC unit controller.</p> <p>(5) Faulty remote controller.</p>	<p>Shut down both OC power source for 5 minutes or more, and make them again.</p> <p>It will return to normal state at an accidental case.</p> <p>When normal state can not be recovered, check for the (1) ~ (4) of the cause.</p>
	3. Remote controller (RC)	Remote controller (RC)	No reply (ACK) at IC transmission to RC	<p>(1) Faulty transmission wiring at IC unit side.</p> <p>(2) Faulty transmission wiring of RC.</p> <p>(3) When remote controller address is changed or modified during operation.</p> <p>(4) Faulty remote controller.</p>	<p>Shut down OC power sources for 5 minutes or more, and make it again.</p> <p>It will return to normal state at an accidental case.</p> <p>When normal state can not be recovered, check for the (1) ~ (4) of the cause.</p>

Checking code	Meaning, detecting method				
6607 (continued)	No ACK abnormality		When no ACK signal is detected in 6 continuous times with 30 seconds interval by transmission side controller, the transmission side detects error.		
<div style="border: 1px solid black; padding: 5px; width: fit-content; margin: auto;">           Note : The address/attribute shown on remote controller indicates the controller not providing the answer (ACK).         </div>					
System composition	Generating unit address	Display of trouble	Detecting method	Cause	Cause checking method & Countermeasure
<b>(2) Group operation system using plural refrigerants</b>	1. Outdoor unit(OC)	Remote controller (RC)	No reply (ACK) at BC transmission to OC	As same that for single refrigerant system.	Same as measure for single refrigerant system.
	2. Indoor unit (IC)	Remote controller (RC)	No reply (ACK) at RC transmission to IC	(1) Cause of (1) ~ (5) of "Cause for single refrigerant system". (2) Disconnection or short circuit of transmission line of OC terminal block for centralized control (TB7). (3) Shut down of OC unit power source of one refrigerant system. (4) Neglecting insertion of OC unit power supply connector (CN40). (5) Inserting more than 2 sets of power supply connector (CN40) for centralized control use.  For generation after normal operation conducted once, the following causes can be considered. <ul style="list-style-type: none"> <li>• Total capacity error (7100)</li> <li>• Capacity code setting error (7101)</li> <li>• Connecting set number error (7102)</li> <li>• Address setting error (7105)</li> </ul>	(a) Shut down the power source of both IC and OC for over 5 minutes simultaneously, and make them again. Normal state will be returned in case of accidental trouble. (b) Check for (1) ~ (5) of causes. If cause is found, remedy it. (c) Check other remote controller or OC unit LED for troubleshooting for trouble.  Trouble →Modify the trouble according to the content of check code. No trouble →Faulty indoor controller
	3. Remote controller (RC)	Remote controller (RC)	No reply (ACK) at IC transmission to RC	(1) Cause of (1) ~ (3) of "Cause for single refrigerant system". (2) Disconnection or short circuit of transmission line of OC terminal block for centralized control (TB7). (3) Shut down of OC unit power source of one refrigerant system. (4) Neglecting insertion of OC unit power supply connector (CN40). (5) Inserting more than 2 sets of power supply connector (CN40) for centralized control use.  At generation after normal operation conducted once, the following causes can be considered. <ul style="list-style-type: none"> <li>• Total capacity error (7100)</li> <li>• Capacity code setting error (7101)</li> <li>• Connecting set number error (7102)</li> <li>• Address setting error (7105)</li> </ul>	(a) Shut down the power source of OC for over 5 minute, and make it again. Normal state will be returned in case of accidental trouble. (b) Check for (1) ~ (5) of causes. If cause is found, remedy it. When normal state can not be obtained, check (1) ~ (5) of causes.

Checking code	Meaning, detecting method				
6607 (continued)	No ACK abnormality		When no ACK signal is detected in 6 continuous times with 30 seconds interval by transmission side controller, the transmission side detects error.		
<div style="border: 1px solid black; padding: 5px; width: fit-content; margin: auto;">           Note : The address/attribute shown on remote controller indicates the controller not providing the answer (ACK).         </div>					
System composition	Generating unit address	Display of trouble	Detecting method	Cause	Cause checking method & Countermeasure
<b>(3) Connecting system with controller (MELANS)</b>	1. Outdoor unit(OC)	Remote controller (RC)	No reply (ACK) at BC transmission to OC	As same that for single refrigerant system.	Same countermeasure as that for single refrigerant system.
	2. Indoor unit (IC)	Remote controller (RC)	No reply (ACK) at transmission of SC to IC	Trouble of partial IC units : (1) Same cause as that for single refrigerant system.	→Same countermeasure as that for single refrigerant system.
				Trouble of all IC in one refrigerant system: (1) Cause of total capacity error. (7100) (2) Cause of capacity code setting error. (7101) (3) Cause of connecting number error. (7102) (4) Cause of address setting error. (7105) (5) Disconnection or short circuit of transmission line of OC unit terminal block for central control (TB7). (6) Power source shut down of OC unit. (7) Trouble of OC unit electrical system.	Confirm OC trouble diagnosis LED. →At trouble generation, check for the content according to check code. Check the content of (5) ~ (7) shown left.
			Trouble of all IC: (1) As same that for single refrigerant system. (2) When using the power supply unit for transmission line, the power supply connector (CN40) is inserted into the transmission line for centralized control. (3) Disconnection or power source shut down of power supply unit for transmission line. (4) Faulty system controller (MELANS).	Confirm voltage of transmission line for centralized control. • More than 20V → Confirm (1) (2) left. • Less than 20V → Confirm (3) left.	

Checking code	Meaning, detecting method				
6607 (continued)	No ACK abnormality		When no ACK signal is detected in 6 continuous times with 30 seconds interval by transmission side controller, the transmission side detects error.		
<div style="border: 1px solid black; padding: 5px; width: fit-content; margin: auto;">           Note : The address/attribute shown on remote controller indicates the controller not providing the answer (ACK).         </div>					
System composition	Generating unit address	Display of trouble	Detecting method	Cause	Cause checking method & Countermeasure
<b>(3) Connecting system with controller (MELANS)</b>	3. Remote controller (RC)	Remote controller (RC)	No reply (ACK) at transmission of IC to RC	Same cause as that for plural refrigerant system.	Same countermeasure as that for plural refrigerant system.
			No reply (ACK) at transmission of MELANS to RC	Trouble of partial IC units: (1) Same cause of that for single refrigerant system.	→Same countermeasure as that for single refrigerant system.
			Trouble of all IC in one refrigerant system: (1) Error detected by OC unit. Total capacity error. (7100) Capacity code setting error. (7101) Connecting number error. (7102) Address setting error. (7105) (2) Disconnection or short circuit of transmission line of OC unit terminal block for central control (TB7). (3) Power source shut down of OC unit. (4) Trouble of OC unit electrical system.	Confirm OC trouble diagnosis LED. →At trouble generation, check for the content according to check code.  Check the content of (2) ~ (4) shown left.	
			Trouble of all IC: (1) As same that for single refrigerant system. (2) When using the power supply unit for transmission line, the power supply connector (CN40) is inserted into the transmission line for centralized control. (3) Disconnection or power shutdown of power supply unit for transmission line. (4) Faulty MELANS.	Check the causes of (1) ~ (4) left.	

Checking code	Meaning, detecting method				
6607 (continued)	No ACK abnormality		When no ACK signal is detected in 6 continuous times with 30 seconds interval by transmission side controller, the transmission side detects error.		
<div style="border: 1px solid black; padding: 5px; width: fit-content; margin: auto;">           Note : The address/attribute shown on remote controller indicates the controller not providing the answer (ACK).         </div>					
System composition	Generating unit address	Display of trouble	Detecting method	Cause	Cause checking method & Countermeasure
<b>(3) Connecting system with controller (MELANS)</b>	4. System controller (SC)	Remote controller (RC)	No reply (ACK) at transmission of IC to SC	Trouble of partial remote controller: (1) Faulty wiring of RC transmission line. (2) Disconnection or poor contact of RC transmission connector. (3) Faulty RC.	Check the causes of (1) ~ (3) left.
				Trouble of all IC in one refrigerant system. (1) Error detected by OC unit. Total capacity error (7100) Capacity code setting error (7101) Connecting number error (7102) Address setting error (7105) (2) Disconnection or short circuit of transmission line of OC unit terminal block for central control (TB7). (3) Power source shut down of OC unit. (4) Trouble of OC unit electrical system.	Confirm OC trouble diagnosis LED. →At trouble generation, check for the content according to check code. Check the content of (2) ~ (4) shown left.
				Trouble of all RC: (1) As same that for single refrigerant system. (2) When using the power supply unit for transmission line, the power supply connector (CN40) is inserted into the transmission line for centralized control. (3) Disconnection or power shutdown of power supply unit for transmission line. (4) Faulty MELANS.	Check the causes (1) ~ (4) left.

Checking code	Meaning, detecting method				
6607 (continued)	No ACK abnormality		When no ACK signal is detected in 6 continuous times with 30 seconds interval by transmission side controller, the transmission side detects error.		
<div style="border: 1px solid black; padding: 5px; width: fit-content; margin: auto;">           Note : The address/attribute shown on remote controller indicates the controller not providing the answer (ACK).         </div>					
System composition	Generating unit address	Display of trouble	Detecting method	Cause	Cause checking method & Countermeasure
<b>No relation with system</b>	Address which should not be existed	-	-	(1) IC unit is keeping the memory of the original group setting with RC although the RC address was changed later. The same symptom will appear for the registration with SC. (2) IC unit is keeping the memory of the original interlocking registration with Fresh Master with RC although the Fresh Master address was changed later.	As some IC units are keeping the memory of the address not existing, delete the information. Employ one of the deleting method among two below. (1) Deletion by remote controller. Delete unnecessary information by the manual setting function of remote controller. (2) Deletion by connecting information deleting switch of OC unit.  <div style="border: 1px solid black; padding: 5px; width: fit-content; margin: auto;">             Be careful that the use of this method will delete all the group information set with RC and all the interlocking information of Fresh Master and IC unit.           </div> (a) Shut down OC unit power source, and wait for 5 minutes. (b) Turn on the dip switch SW2-2 provided on OC unit control circuit board. (c) Make OC unit power source, and wait for 5 minutes. (d) Shut down OC unit power source, and wait for 5 minutes. (e) Turn off the dip switch SW2-2 provided on OC unit control circuit board. (f) Make OC unit power source.

Checking code	Meaning, detecting method	Cause	Checking method & Countermeasure
6608	No response abnormality  Though acknowledgment of receipt (ACK) is received after transmission, no response command is returned. Detected as error by transmission side when the same symptom is repeated 10 times with an interval of 3 seconds.  <div style="border: 1px solid black; padding: 5px; width: fit-content; margin: auto;">             Note:              The address/attribute shown on remote controller indicates the controller which has detected error.           </div>	(1) At the collision of mutual transmission data when transmission wiring is modified or the polarity is changed while turning the power source on, the wave shape changes detecting error. (2) Repeating of transmission error due to noise. (3) Damping of transmission line voltage/ signal due to exceeding of the acceptable range for transmission wiring. <ul style="list-style-type: none"> <li>• Farthest Less than 200m</li> <li>• RC wiring Less than 12m</li> </ul> (4) Damping of transmission voltage/ signal due to improper type of transmission line. <ul style="list-style-type: none"> <li>• Wire size More than 1.25mm<sup>2</sup></li> </ul>	(a) Generation at test run. Turn off the power sources of OC unit, IC unit and Fresh Master for more than 5 minutes simultaneously, and make them again. →Returning to normal state means the trouble detection due to transmission line work while powering. (b) Check (3) and (4) of the causes left. (c) Investigate the transmission wave shape/noise on transmission line according to <Investigation method of transmission wave shape/noise>.  <div style="border: 1px solid black; border-radius: 15px; padding: 5px; width: fit-content; margin: auto;">             Much possibility if 6602 is generated.           </div>

Checking code		Meaning, detecting method	Factor	Checking method & Remedy
6831	MA Communication no reception error	1. Communication between the MA remote controller and the indoor unit is not done properly. 2. No proper data has been received for 3 minutes.	(1) The remote control line of the MA remote controller or the indoor unit has a poor contact. (2) All remote controllers are slaves. (3) The wiring specifications are not observed. 1. Wire length 2. Wire thickness 3. Number of remote controllers 4. Number of indoor units (4) After the remote controller is connected, disconnection of the remote controller without resetting the power. (5) Noise enters the transfer path of the remote controller. (6) The transmission/reception circuit of the remote controller of the indoor unit is poor. (7) The transmission/reception circuit of the remote controller is defective.	(1) Check the transmission lines of the indoor unit and MA remote controller for disconnection and looseness. (2) Check the power supply to the main power and remote controller lines. (3) Check whether the tolerable range of the MA remote controller line is exceeded or not. (4) Check the main/slave setting of the MA remote controller. (5) Diagnose the remote controller. (Remote controller IM description) Result: [OK]: No problem in the remote controller (wiring specifications check) [NO]: Replace the remote controller
6834	MA Communication start bit error	1. Communication between the MA remote controller and the indoor unit is not done properly. 2. No proper data has been received for 2 minutes.	(1) The remote control line of the MA remote controller or the indoor unit is in poor contact. (2) It is set on two or more main remote controllers. (3) The indoor unit address is set twice. (4) Noise enters the remote controller line. (5) The wiring specifications are not observed. 1. Wire length 2. Wire thickness 3. Number of remote controllers 4. Number of indoor units (6) The transmission/reception circuit of the remote controller is defective.	[6832, 6833, ERC]: Noise is the cause. < To (6) > (6) Check the transmission waveform and noise on the transmission signal of MA remote controller line. (7) If no problem is present in items. (1) to (6) above, replace the indoor controller board or MA remote controller. The following states can be checked from LED1 and LED2 on the indoor controller board. • LED1 is lit at the same time. The main power is supplied to the indoor unit. • LED2 alone is lit. Power is supplied to the MA remote controller line.
6832	MA Communication synchroniza- tion recovery error	1. Communication between the MA remote controller and the indoor unit is not done properly. 2. When transmission is impossible because the emptiness of the transfer path cannot be checked. Indoor unit : 3 minutes Remote controller : 6 seconds	(1) The remote control line of the MA remote controller or the indoor unit is in poor contact. (2) It is set on two or more main remote controllers. (3) The indoor unit address is set twice. (4) Noise enters the remote controller line. (5) The wiring specifications are not observed. 1. Wire length 2. Wire thickness 3. Number of remote controllers 4. Number of indoor units (6) The transmission/reception circuit of the remote controller is defective.	[6832, 6833, ERC]: Noise is the cause. < To (6) > (6) Check the transmission waveform and noise on the transmission signal of MA remote controller line. (7) If no problem is present in items. (1) to (6) above, replace the indoor controller board or MA remote controller. The following states can be checked from LED1 and LED2 on the indoor controller board. • LED1 is lit at the same time. The main power is supplied to the indoor unit. • LED2 alone is lit. Power is supplied to the MA remote controller line.
6833	MA Communication transmission /reception hardware error	1. Communication between the MA remote controller and the indoor unit is not done properly. 2. When the transmitted data is received at the same time and compared, the different state continues 30 times.	(1) The remote control line of the MA remote controller or the indoor unit is in poor contact. (2) It is set on two or more main remote controllers. (3) The indoor unit address is set twice. (4) Noise enters the remote controller line. (5) The wiring specifications are not observed. 1. Wire length 2. Wire thickness 3. Number of remote controllers 4. Number of indoor units (6) The transmission/reception circuit of the remote controller is defective.	[6832, 6833, ERC]: Noise is the cause. < To (6) > (6) Check the transmission waveform and noise on the transmission signal of MA remote controller line. (7) If no problem is present in items. (1) to (6) above, replace the indoor controller board or MA remote controller. The following states can be checked from LED1 and LED2 on the indoor controller board. • LED1 is lit at the same time. The main power is supplied to the indoor unit. • LED2 alone is lit. Power is supplied to the MA remote controller line.



### 3. System error

Checking code	Meaning, detecting method	Cause	Checking method & Countermeasure																						
7100	<p>Total capacity abnormality</p> <p>Total capacity of indoor units in the same refrigerant system exceeds limitations.</p> <p>Trouble source : Outdoor unit</p>	<p>(1) Total capacity of indoor units in the same refrigerant system exceeds the following:</p> <table border="1"> <thead> <tr> <th>Model</th> <th>Total capacity</th> </tr> </thead> <tbody> <tr><td>P200</td><td>260</td></tr> <tr><td>P250</td><td>325</td></tr> <tr><td>P300</td><td>390</td></tr> <tr><td>P350</td><td>455</td></tr> <tr><td>P400</td><td>520</td></tr> <tr><td>P450</td><td>585</td></tr> <tr><td>P500</td><td>650</td></tr> <tr><td>P550</td><td>715</td></tr> <tr><td>P600</td><td>780</td></tr> <tr><td>P650</td><td>845</td></tr> </tbody> </table>	Model	Total capacity	P200	260	P250	325	P300	390	P350	455	P400	520	P450	585	P500	650	P550	715	P600	780	P650	845	<p>(a) Check for the model total (capacity cord total) of indoor units connected.</p> <p>(b) Check for the switch (SW2 on indoor controller board) for setting of the model name of the indoor unit connected.</p> <p>For erroneous switch setting, modify it, turn off power source of outdoor unit, and indoor unit simultaneously for 5 minutes or more to modify the switch for setting the model name (capacity code).</p>
Model	Total capacity																								
P200	260																								
P250	325																								
P300	390																								
P350	455																								
P400	520																								
P450	585																								
P500	650																								
P550	715																								
P600	780																								
P650	845																								
7101	<p>Capacity code abnormality</p> <p>Error display at erroneous connection of Indoor unit of which model name can not be connected.</p> <p>Trouble source : Outdoor unit Indoor unit</p>	<p>(1) The Indoor unit model name (model code) connected is not connectable. Connectable range : 20 ~ 250</p> <p>(2) Erroneous setting of the switch (SW2) for setting of model name of indoor unit connected.</p>	<p>(a) Check for the model total (capacity cord total) of indoor units connected.</p> <p>(b) Check for the switch (SW2 on indoor controller board) for setting of Indoor unit model name of generating address. When it is not agreed to the model name, modify the capacity code while shutting off the power source of both Indoor and outdoor units.</p> <p>※ The capacity of Indoor unit can be confirmed by the self-diagnosis function (SW1 operation) of indoor unit.</p>																						
7102	<p>Error in the number of connected units</p> <p>Number of units connected in the same refrigerant system exceeds limitations.</p> <p>Trouble source: Outdoor unit</p>	<p>(1) Number of unit connected to terminal block (TB3) for outdoor/indoor transmission line exceeds limitations given below:</p> <table border="1"> <thead> <tr> <th>Item</th> <th>Number of units</th> </tr> </thead> <tbody> <tr> <td rowspan="6">1) Total number of indoor units</td> <td>1~13 : P200 type</td> </tr> <tr> <td>1~16 : P250 type</td> </tr> <tr> <td>1~19 : P300 type</td> </tr> <tr> <td>1~20 : P350 type</td> </tr> <tr> <td>1~22 : P400 type</td> </tr> <tr> <td>1~24 : P450~P550 types</td> </tr> <tr> <td>1~32 : P600,P650 types</td> </tr> <tr> <td>2) Number of LOSSNAY units (Only when the free address is set.)</td> <td>0 or 1</td> </tr> </tbody> </table> <p>(2) Disconnection of transmission wiring at outdoor unit.</p> <p>(3) Short circuit of transmission line in case of (2) and (3), remote controller displays "HO".</p>	Item	Number of units	1) Total number of indoor units	1~13 : P200 type	1~16 : P250 type	1~19 : P300 type	1~20 : P350 type	1~22 : P400 type	1~24 : P450~P550 types	1~32 : P600,P650 types	2) Number of LOSSNAY units (Only when the free address is set.)	0 or 1	<p>(a) Check whether the connection of units to the terminal block for indoor/outdoor transmission wiring (TB3) of outdoor unit is not exceeding the limitation. (See (1) ~ (2) left.)</p> <p>(b) Check for (2), (3), and (4).</p> <p>(c) Check for the connection of transmission wiring to the terminal block for centralized control is erroneously connected to the indoor/outdoor transmission wiring terminal block (TB3).</p> <p>(d) Check for the model total (capacity code total) of indoor units connected.</p>										
Item	Number of units																								
1) Total number of indoor units	1~13 : P200 type																								
	1~16 : P250 type																								
	1~19 : P300 type																								
	1~20 : P350 type																								
	1~22 : P400 type																								
	1~24 : P450~P550 types																								
1~32 : P600,P650 types																									
2) Number of LOSSNAY units (Only when the free address is set.)	0 or 1																								
7105	<p>Address setting abnormality</p> <p>• Erroneous setting of OC unit address</p> <p>Trouble source: Outdoor unit</p>	<p>(1) Setting error of outdoor unit address. The address of outdoor unit is not being set to 51 ~ 100.</p>	<p>Check that the address of OC unit is being set to 51 ~ 100. Reset the address if it stays out of the range, while shutting the power source off.</p>																						

Checking code	Meaning, detecting method	Cause	Checking method & Countermeasure
7110	Connection number setting abnormality	(1) Transmission booster is faulty. (2) Power supply of transmission booster has been cut.	Check transmission booster and power supply.
7111	Remote control sensor abnormality  Error not providing the temperature designed to remote controller sensor.  Trouble source : Indoor unit	(1) The remote controller without the temperature sensor (the wireless remote controller or the M-NET compact remote controller (mounted type)) is used and the remote controller sensor for the indoor unit is specified. (SW1-1 is ON.)	(a) Replace the remote controller with the one with built-in temperature sensor.
7113	Functional restriction error	Disconnection of plug on main board.	Check all main board connectors and rectify faulty connection.
7116	System error before flashing operation  The refrigerant pipe has not been washed.	The model-switching switch (SW4-3) is set wrong. It is set to Replace MULTI.	Check that the SW4-3 on the main board is OFF.
7117	Unset model error	Faulty wiring Disconnected connector, shorting, or contact failure.	Check for the contact of the connector CNTYP1, 4, 5 on the main board. Check the record of CNTYP1, 4, 5.
7130	Different unit model error  The check code will appear when the indoor units with different refrigerant systems are connected.	The indoor unit that uses only R22 or only R407C refrigerant is connected.  The wrong unit model is connected.  When connecting the slim model (A control) with M-NET, the connection adapter for M-NET is connected to the indoor unit.	Check the connected indoor unit model.  Check whether the connecting adapter for M-NET is not connected to the indoor unit. (Connect the connecting adapter for M-NET to the outdoor unit.)

#### 4. Trouble shooting according to the remote controller malfunction and the external input error

(1) In the case of MA remote controller

	Phenomena	Factors	Checke method & Handling
1	<p>Even if the operation SW on the remote controller is pressed, the display remains unlit and the unit does not start running.</p> <p>(Power indicator ● does not appear on the screen.)</p>	<p>(1) The power for the indoor unit is not on.</p> <p>① The power of the indoor unit is OFF.</p> <p>② The connector on the indoor unit controller board has come off.</p> <p>③ The fuse on the indoor unit controller board has melted.</p> <p>④ Transformer failure and disconnected wire of the indoor unit</p> <p>(2) The wire for the MA remote controller is connected incorrectly.</p> <p>① Disconnected wire for the MA remote controller and disconnected line to the terminal block.</p> <p>② Short circuit of the wire for the MA remote controller</p> <p>③ Reversed connection of the wire for the MA remote controller</p> <p>④ The wire for the MA remote controller is connected incorrectly to the terminal block for the transmission line (TB5).</p> <p>⑤ Reversed connection between the wire for the MA remote controller and the power-supply wire for AC220~240V.</p> <p>⑥ Reversed connection inside the indoor unit between the wire for the MA remote controller and the M-NET transmission line.</p> <p>(3) The number of the MA remote controllers that are connected to an indoor unit exceeds the allowable range (2 units).</p> <p>(4) The length and the diameter of the wire for MA remote controller are out of specification.</p> <p>(5) Short circuit of the wire for the remote display output for the outdoor unit or reversed polarity connection of the relay.</p> <p>(6) Indoor unit controller board failure</p> <p>(7) MA remote controller failure</p>	<p>(a) Check voltage of the MA remote controller terminal (among ① to ③).</p> <p>i) If the voltage is DC8.5-12V, the remote controller is defective.</p> <p>ii) If there is no voltage Check the left described (1) and (3). If a fault is found, handle the problem. If no fault is found, refer to (b).</p> <p>(b) Remove the wire for the remote controller from the terminal block (TB13) on the MA remote controller for the indoor unit, and check voltage among ① to ③.</p> <p>i) If the voltage is DC8.5-12V Check the left described (2) and (4). If a fault is found, handle the problem.</p> <p>ii) If there is no voltage Check the left described (1) again. If a fault is found, handle the problem. If no fault is found, check the wire for the remote display output (the relay polarity). If no further fault is found, replace the indoor controller board.</p>

	Phenomena	Factors	Checke method & Handling
2	When turning on the remote controller operation SW, a temporary operation display is indicated, and the display lights out immediately, and the unit stops.	<p>(1) The power for the M-NET transmission line is not supplied from the outdoor unit.</p> <p>(2) Short circuit of the transmission line.</p> <p>(3) Incorrect wiring of the M-NET transmission line on the outdoor unit side.</p> <p>① Disconnected wire for the MA remote controller and disconnected line to the terminal block.</p> <p>② The indoor transmission line is connected incorrectly to terminal block (TB7) to the transmission line for centralized control.</p> <p>③ The power supply connectors (CN40) for multiple outdoor units are inserted.</p> <p>Or the power supply connector (CN40) for outdoor unit is inserted in the system to which the power supply unit for transmission line is connected.</p> <p>(4) Disconnected M-NET transmission line on the indoor unit side.</p> <p>(5) Disconnected wire between terminal block (TB5) to the M-NET transmission line of the indoor unit and the indoor controller board (CN2M) or disconnected connector.</p>	<div style="border: 1px solid black; padding: 5px; width: fit-content;"> <p>When the factor (2) and (3) apply, self-diagnosis LED works and the check code 7102 will be displayed.</p> </div>

**Check method & Handling**

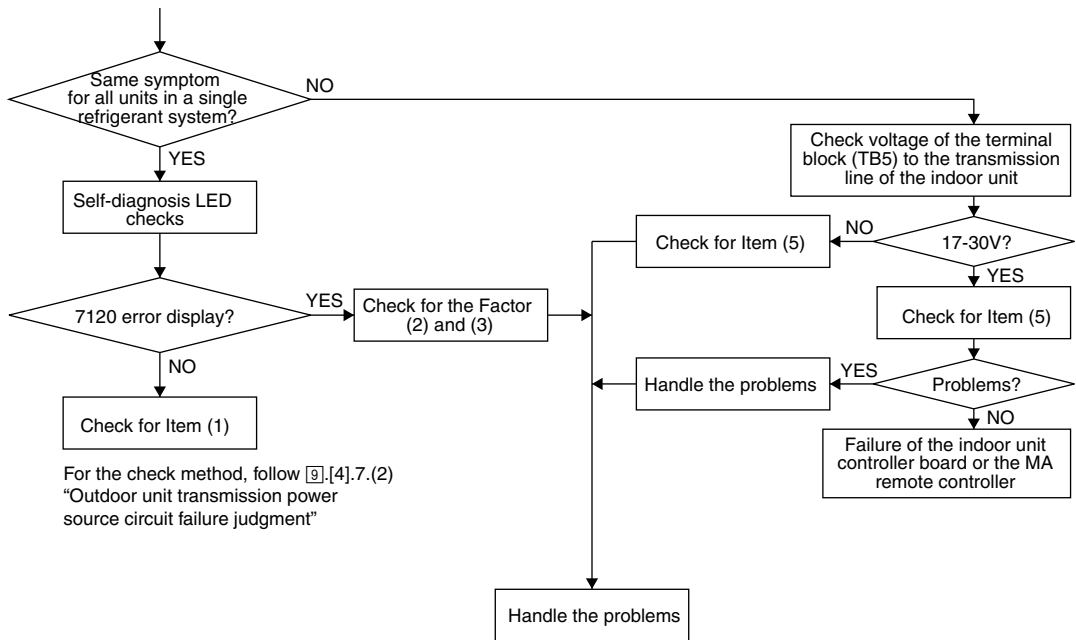

	Phenomena	Factors
3	<p>“HO” display on the remote controller does not turn off, and the switch does not work.</p> <p>(“HO” display turn off 3 minutes later, after turning the power on.)</p>	<p>(1) The power for the M-NET transmission line is not supplied from the outdoor unit.</p> <p>(2) Short circuit of the transmission line.</p> <p>(3) Incorrect wiring of the M-NET transmission line on the outdoor unit side.</p> <p>① Disconnected wire for the MA remote controller and disconnected line to the terminal block.</p> <p>② The indoor transmission line is connected incorrectly to terminal block (TB7) to the transmission line for centralized control.</p> <p>③ The power supply connectors (CN40) for multiple outdoor units are inserted. Or the power supply connector (CN40) for outdoor unit is inserted in the system to which the power supply unit for transmission line is connected.</p> <p>(4) Disconnected M-NET transmission line on the indoor unit side.</p> <p>(5) Disconnected wire between terminal block (TB5) to the M-NET transmission line of the indoor unit and the indoor controller board (CN2M) or disconnected connector.</p> <p>(6) The wire for the MA remote controller is connected incorrectly.</p> <p>① Short circuit of the wire for the MA remote controller.</p> <p>② Disconnected wire for the MA remote controller (No.2) and disconnected line to the terminal block.</p> <p>③ Reversed connection under group control.</p> <p>④ The wire for the MA remote controller is connected incorrectly to the terminal block to the transmission line (TB5).</p> <p>⑤ The M-NET transmission line is connected incorrectly to the terminal block (TB13) on the MA remote controller.</p> <p>(7) The sub/main setting of the MA remote controller is set to sub.</p> <p>(8) More than 2 main MA remote controllers are connected.</p> <p>(9) Indoor unit controller board failure (MA remote controller communication line)</p> <p>(10) Remote controller failure.</p>

When the factor (2) and (3) apply, self-diagnosis LED works and the check code 7102 will be displayed.

**Check method & Handling**

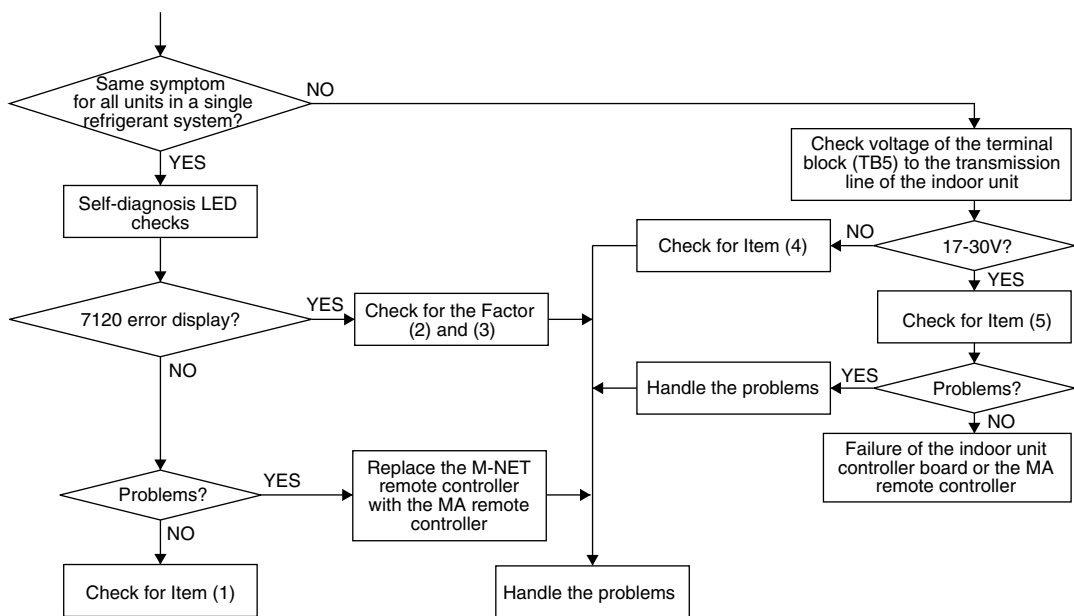

For the check method, follow [9].[4].7.(2)  
“Outdoor unit transmission power source circuit failure judgment”

<Flow chart>

Even if the operation SW on the remote controller is pressed, the indoor and the outdoor units do not start running.

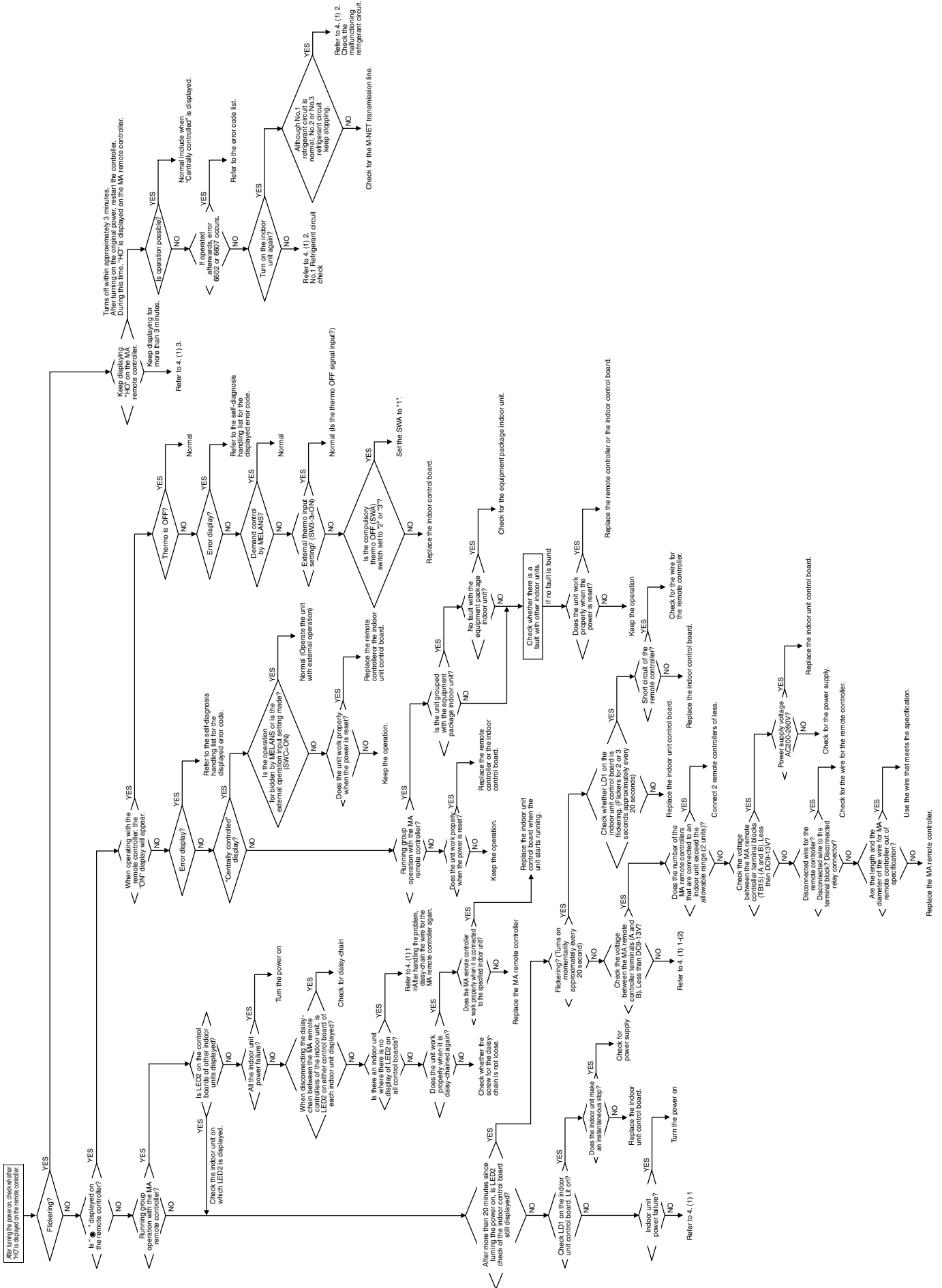

(2) In the case of the M-NET remote controller

	Phenomena	Factors	Check method & Handling
1	<p>Even if the operation SW on the remote controller is pressed, the display remains unlit and the unit does not start running.</p> <p>(Power indicator ● does not appear on the screen.)</p>	<p>(1) The power for the M-NET transmission line is not supplied from the outdoor unit.</p> <p>(2) Short circuit of the transmission line</p> <p>(3) Incorrect wiring of the M-NET transmission line on the outdoor unit side.</p> <p>① Disconnected wire for the MA remote controller and disconnected line to the terminal block.</p> <p>② The indoor transmission line is connected incorrectly to terminal block (TB7) to the transmission line for centralized control.</p> <p>(4) Disconnected transmission line on the remote controller side</p> <p>(5) Remote controller failure</p>	<p>(a) Check voltage of the M-NET remote controller transmission terminal.</p> <p>i) If the voltage is 17V-30V →The M-NET remote controller is defective.</p> <p>ii) If there is 17V or less →Refer to [9].[4].7.(2) "Outdoor unit transmission power source circuit failure judgment".</p> <div style="border: 1px solid black; padding: 5px; margin-top: 10px;"> <p>When the factor (2) and (3) apply, self-diagnosis LED of the outdoor unit works and the check code 7102 will be displayed.</p> </div>
2	<p>When turning on the remote controller operation SW, a temporary operation display is indicated, and the display lights out immediately.</p>	<p>(1) The power for the indoor unit is not on.</p> <p>① The main power of the indoor unit (AC220~240V) is OFF.</p> <p>② The connector on the indoor unit controller board has come off.</p> <p>③ The fuse on the indoor unit controller board has melted.</p> <p>④ Transformer failure and disconnected wire of the indoor unit.</p> <p>⑤ The indoor controller board failure.</p> <p>(2) The main board of the indoor and the outdoor unit failure As the indoor unit does not interact with the outdoor unit, the outdoor unit model cannot be recognized.</p>	

**Check method & Handling**

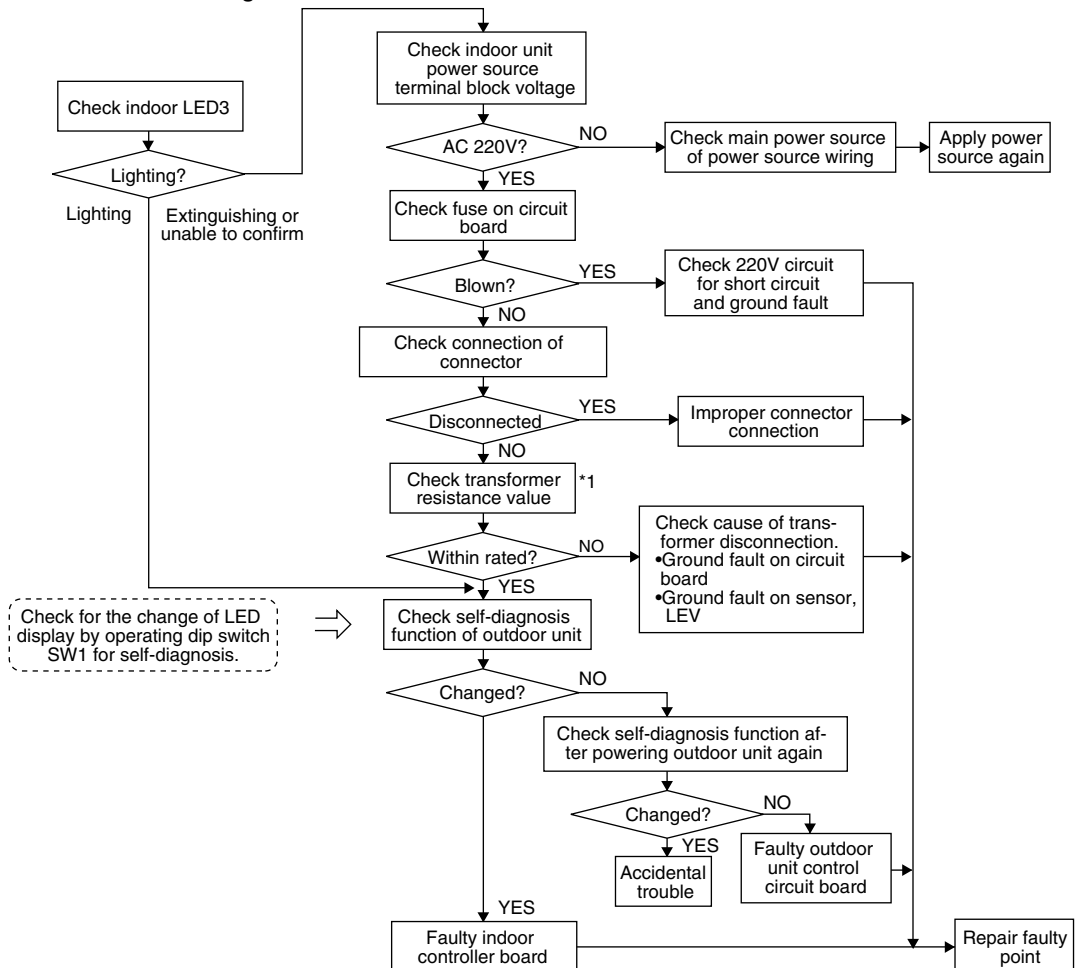

\*1 Check the transformer in accordance with the "TROUBLESHOOTING" in the indoor unit's service handbook.

	Phenomena	Factors
3	<p>“HO” display on remote controller does not disappear and ON/OFF switch is ineffective.</p>	<p>(Without using MELANS)</p> <ol style="list-style-type: none"> <li>(1) Outdoor unit address is set to “00”</li> <li>(2) Erroneous address.               <ol style="list-style-type: none"> <li>① Address setting of indoor unit to be coupled with remote controller incorrect. (Indoor unit = remote controller – 100.)</li> <li>② Address setting of remote controller incorrect. (Remote controller = indoor unit + 100.)</li> </ol> </li> <li>(3) Faulty wiring of transmission terminal block TB5 of indoor unit in the same group with remote controller.</li> <li>(4) Centralized control SW2-1 of outdoor unit is turned ON.</li> <li>(5) Disconnection or faulty wiring of indoor unit transmission line.</li> <li>(6) Disconnection between indoor unit M-NET transmission line terminal block (TB5) and connector CN2M.</li> <li>(7) More than 2 sets of power supply connector (CN40) are inserted into centralized control transmission line of outdoor unit.</li> <li>(8) M-NET remote controller is connected to the terminal block of MA remote controller.</li> <li>(9) Faulty outdoor unit control circuit board.</li> <li>(10) Faulty indoor controller board.</li> <li>(11) Faulty remote controller.</li> </ol> <p>(Interlocking control with MELANS)</p> <ol style="list-style-type: none"> <li>(12) No grouping registration from MELANS (Neglecting to set the relation between indoor unit and network remote controller).</li> <li>(13) Disconnection of centralized control transmission line (TB7) at outdoor unit.</li> <li>(14) Power supply connectors (CN40) of Multiple outdoor units are inserted into transmission lines. Or in the system to which power supply unit for transmission line, power supply of the outdoor unit (CN40) is inserted into transmission line.</li> </ol>

**Check method & Handling**

In case MELANS is not used

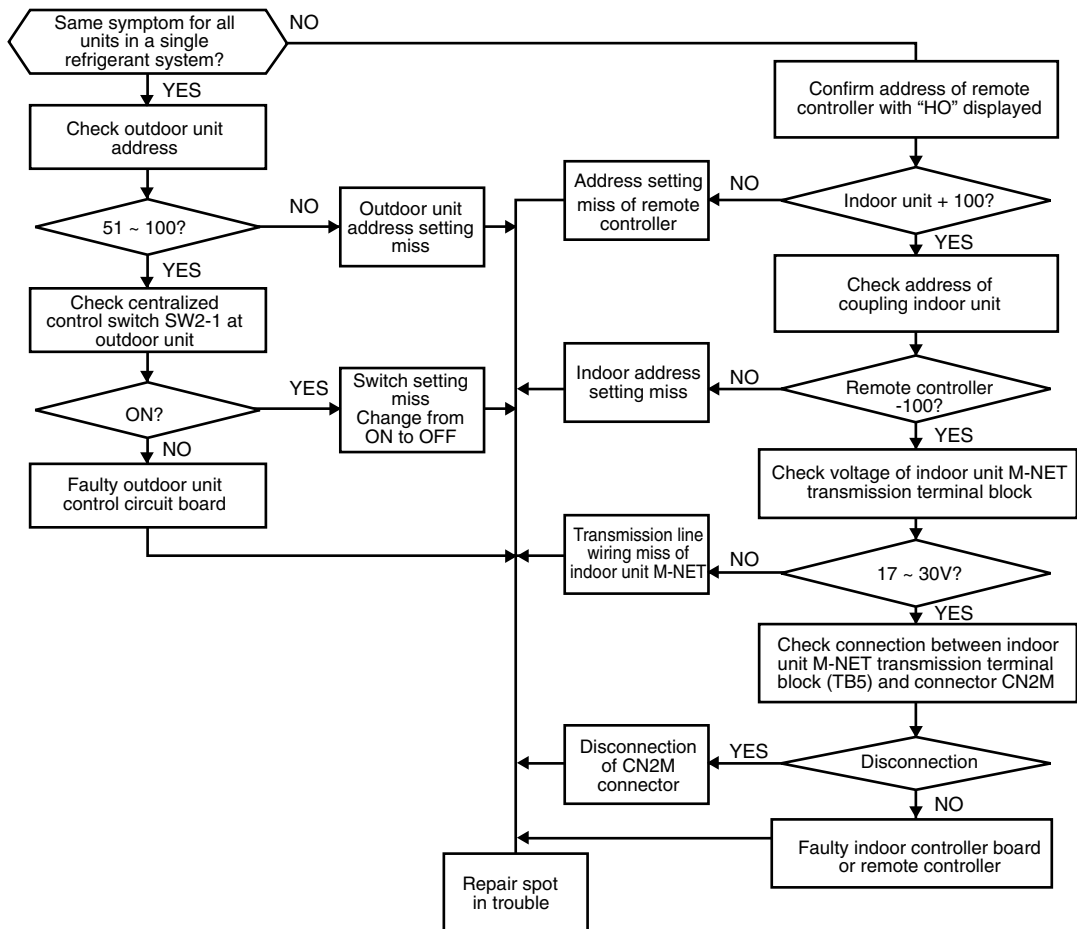

**In case with MELANS used**



When MELANS is used, “HO” display on the remote controller will disappear at the group registration of the indoor unit and local remote controller. If “HO” does not disappear after the registration, check the items (11) ~ (13) in the Factors column.

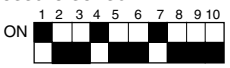
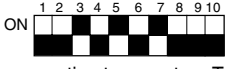
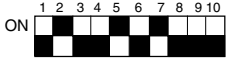

	Phenomena	Factors	Checke method & Handling
4	"88" appears on remote controller at registration and access remote controller.	(Generates at registration and confirmation) (1) Erroneous address of unit to be coupled. (2) Disconnection of transmission line of unit to be coupled (No connection). (3) Faulty circuit board of unit to be coupled. (4) Installation miss of transmission line.	(a) Confirm the address of unit to be coupled. (b) Check the connection of transmission line. (c) Check the transmission terminal block voltage of unit to be coupled. i) Normal if voltage is DC17 ~ 30V. ii) Check the item d) in case other than i).
		(Generates at interlocking registration between LOSSNAY and the indoor unit) (5) The power of LOSSNAY is OFF.	(d) Check for the main power of LOSSNAY.
		(Confirmation of different refrigerant system controller) (6) Disconnection of power source of outdoor unit to be confirmed. (7) Disconnection of centralized control transmission line (TB7) of outdoor unit. (8) Power supply connector (CN40) is not inserted into centralized control transmission line in grouping with different refrigerant system without using MELANS. (9) More than 2 sets of power supply connector are inserted into the centralized control transmission line of outdoor unit. (10) In the system connected with MELANS, power supply connector (CN40) is inserted into the centralized control transmission line of outdoor unit. (11) Short circuit of centralized control transmission line.	(e) Confirm the power source of outdoor unit to be coupled with the unit to be confirmed. (f) Confirm that the centralized control transmission line (TB7) of outdoor unit is not disconnection. (g) Confirm the voltage of centralized control transmission line. i) Normal in case of 10V ~ 30V. ii) Check the items (8) ~ (11) left in case other than i).

(3) Both for MA remote controller and M-NET remote controller

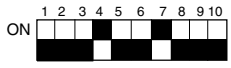
	Phenomena	Factors	Checke method & Handling
1	Cooling with normal remote controller display but not providing capacity.	<p>(1) Insufficient frequency rise</p> <ul style="list-style-type: none"> <li>① Faulty detection of pressure sensor.</li> <li>② Higher discharge temperature exceeding frequency limit.</li> <li>③ Higher high pressure exceeding frequency limit.</li> <li>④ Low pressure excessively lowered.</li> </ul> <p>(2) Faulty action of indoor unit LEV</p> <ul style="list-style-type: none"> <li>① Faulty action of indoor unit LEV does not allow sufficient flow rate. Frequency does not rise due to lowered low pressure.</li> <li>② Leaking LEV of stopping unit lowers flow rate of operating unit.</li> </ul> <p>(3) Abnormal speed of outdoor unit fan</p> <ul style="list-style-type: none"> <li>① Faulty motor or board, or heat exchanger clogging lowers airflow rate.</li> <li>② Faulty temperature intake of OA sensor causes fan control malfunction.</li> <li>③ Faulty intake of pressure sensor causes fan control malfunction.</li> </ul> <p>(4) Long piping length Pressure loss degree at pressure side varies cooling capacity greatly.</p> <p>(5) Piping size is not proper (slender)</p> <p>(6) Insufficient refrigerant volume Discharge temperature rises while frequency does not rise.</p>	<p>(a) Observe difference between sensor detected pressure and actual pressure by monitoring with LED. →At abnormal intake, check the pressure sensor. (Refer to Troubleshooting of Pressure Sensor).</p> <p>Note: Lower intake of low pressure sensor than actual pressure causes insufficient capacity.</p> <p>SW1 setting High pressure sensor</p>  <p>Low pressure sensor</p>  <p>(b) Observe difference between evaporating temperature (Te) and target evaporating temperature (Tem) by monitoring with LED.</p> <p>Note: Higher Te than Tem causes insufficient capacity.</p> <p>SW1 setting Evaporating temperature Te</p>  <p>Target evaporating temperature Tem</p>  <p>Note: When frequency does not rise even at higher Te than Tem, frequency restriction by discharge temperature or high pressure may be affected. At high discharge temperature →Refer to 1102 At high pressure →Refer to 1302</p> <p>Refer to the page of LEV troubleshooting ( [9].[4].5 )</p> <p>Refer to the page of outdoor unit fan troubleshooting. Refer to the page of 5106. Refer to the page of 1302.</p> <p>Check the characteristic of capacity decrease by piping length. Piping pressure loss is assumable by temperature difference between heat exchanger outlet temperature of indoor unit and OC evaporation temp. (Te). →Modify piping.</p> <p>Refer to Item 1-(1) (Frequency does not rise sufficiently.) Refer to Item Refrigerant volume adjustment.</p>

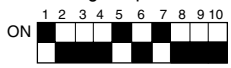
	Phenomena	Factors	Checke method & Handling
1	Cooling with normal remote controller display but not providing capacity.	(7) Clogging by foreign matter	Check temperature difference between before and after a portion (strainer, distributor) of low pressure piping where foreign matter may likely be clogged. Significant temperature drop may indicate clogging. →Remove foreign matter inside piping.
		(8) Indoor unit inlet temperature excessively low (Less than 15°C wet bulb)	Check inlet temperature and short cycle at indoor unit side. To improve using manner
		(9) Faulty compressing Leaking inside compressor lowers refrigerant circulation volume.	As leaking if existed increases discharge temperature, judge by measuring the temperature.
		(10) Faulty action of LEV1 As sufficient sub-cooling can not be kept at outdoor unit outlet due to faulty LEV1 action, refrigerant is difficult to flow at indoor unit.	Refer to page of LEV troubleshooting ( [9].[4].5 ) High possibility at little or no difference between TH5 and TH7
		(11) Faulty TH5, TH7, HPS sensor, erroneous wiring. No normal control of LEV1	a) Check thermistor. b) Check wiring.
2	Heating with normal remote controller display but not providing capacity.	(1) Insufficient frequency rise ① Faulty detection of pressure sensor ② Higher discharge temperature exceeding frequency limit ③ Higher high pressure exceeding frequency limit	a) Observe difference between sensor detected pressure and actual pressure by monitoring with LED. →At abnormal intake, check the pressure sensor. (Refer to Troubleshooting of Pressure Sensor Note: Higher intake of high pressure sensor than actual pressure causes insufficient capacity.  SW1 setting High pressure sensor  Low pressure sensor  (b) Observe difference between condensing temperature (Tc) and target condensing temperature (Tcm) by monitoring with LED. Note: Higher Te than Tem causes insufficient capacity.  SW1 setting Condensing temperature Tc  Target condensing temperature Tcm  Note: When frequency does not rise even at lower Tc than Tcm, frequency restriction by discharge temperature or high pressure may be affected. At high discharge temperature →Refer to 1102 At high pressure →Refer to 1302
		(2) Faulty action of indoor unit LEV Faulty action of indoor unit LEV does not allow sufficient flow rate.	Refer to the page of LEV troubleshooting.

	Phenomena	Factors	Checke method & Handling
2	Heating with normal remote controller display but not providing capacity.	(3) When abnormal temperature of indoor unit piping temperature sensor is taken higher, LEV is throttled excessively due to apparent small sub-cooling.	Check piping thermistor.
		(4) Abnormal speed of outdoor unit fan ① Faulty motor or board, or heat exchanger clogging lowers airflow rate. This lowers airflow rate and low pressure leading to increase discharge temperature. ② Faulty temperature intake of piping sensor causes fan control malfunction.	Refer to the page of outdoor unit fan.
		(5) Faulty insulation of refrigerant piping	
		(6) Long piping length Excessively long piping length at high pressure side causes high pressure loss leading to decrease in high pressure.	Check the characteristic of capacity decrease by piping length. →Modify piping  Check pressure difference between before and after a portion (strainer, distributor) of high pressure (gas) piping where foreign matter may likely be clogged. Difficult to confirm clogging inside extended piping. Check clogging in the same manner in cooling by operating under cooling cycle. →Remove foreign matter
		(7) Piping size is not proper (slender)  (8) Clogging by foreign matter	
		(9) Indoor unit inlet temperature excessively high (exceeding 28°C)	Check inlet temperature and short cycle at indoor unit side. To improve using manner
		(10) Insufficient refrigerant volume Discharge temperature drops while frequency does not rise. Likely to enter refrigerant recovery operation.	Refer to Item 2-(1). (Insufficient frequency rise) Refer to Item Refrigerant volume adjustment.
		(11) Faulty compressing (as same in case of cooling)	Check discharge temperature.
3	As a previous step to apply emergency stop under error mode, the first detection will not be applied with emergency stop as it is stopping under the 3 minutes restart prevention mode as an intermittent fault checking. ① High pressure error ② Discharge temperature error ③ Radiator panel thermistor error ④ Thermistor error ⑤ Pressure sensor error ⑥ Overcurrent shutout ⑦ Refrigerant over charge error  Notes:1. Freeze protection tripping only under cooling mode may be considered in addition to the above. (Freeze protection is detected by one or all indoor units.) 2. With some error codes, emergency stop is not commenced even at the second stopping.	(a) Check the mode operated in the past by displaying intermittent fault check history by LED display with SW1. (b) Check the mode for stopping through the operation reproduced displaying intermittent fault checking by LED display with SW1. ↓ For each error mode, refer to the relating page. *: When checking freeze protection tripping, set SW1 to the status displaying indoor piping temperature table (Chapter 10) to confirm the temperature.	

### [3] Investigation of Transmission Wave Shape/Noise

#### 1. M-NET transmission

Control is performed by exchanging signals between outdoor unit, indoor unit and remote controller by M-NET transmission. If noise should enter into the transmission line, the normal transmission will be hindered causing erroneous operation.

##### (1) Symptom caused by the noise entered into transmission line

Cause	Erroneous operation	Error code
Noise entered into transmission line	Signal changes and is misjudged as the signal of other address.	6600
	Transmission wave shape changes to other signal due to noise.	6602
	Transmission wave shape changes due to noise, and can not be received normally thus providing no reply (ACK).	6607
	Transmission can not be made continuously due to the entry of fine noise.	6603
	Transmission can be made normally, but reply (ACK) or answer can not be issued normally due to noise.	6607 6608

##### (2) Method to confirm wave shape

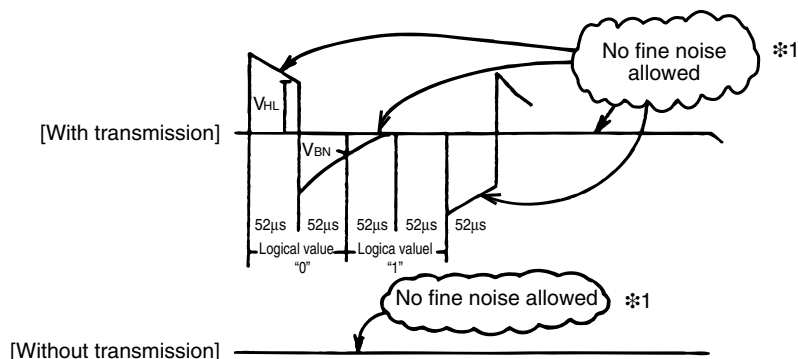

Check the wave shape of transmission line with an oscilloscope to confirm that the following conditions are being satisfied.

- 1) The figure should be  $104\mu\text{s/bit} \pm 1\%$ .
- 2) No finer wave shape (noise) than the transmission signal ( $52\mu\text{s} \pm 1\%$ ) should be allowed. \*\*:1
- 3) The sectional voltage level of transmission signal should be as follows.

Logic value	Transmission line voltage level
0	$V_{HL} = 2.0\text{V}$ or more
1	$V_{BN} = 1.3\text{V}$ or less

\*\*:1 However, minute noise from the DC-DC converter or inverter operation may be picked up.

**(3) Checking and measures to be taken**

(a) Measures against noise

Check the items below when noise can be confirmed on wave shape or the error code in the item (1) is generated.

	Items to be checked	Measures to be taken
Checking for wiring method	(1) Wiring of transmission and power lines in crossing.	Isolate transmission line from power line (5cm or more). Never put them in a same conduit.
	(2) Wiring of transmission line with that of other system in bundle.	Wire transmission line isolating from other transmission line. Wiring in bundle may cause erroneous operation like crosstalk.
	(3) Use of shield wire for transmission line (for both indoor unit control and centralized control).	Use specified transmission wire. Type : Shield line CVVS/CPEVS Wire diameter : 1.25mm <sup>2</sup> or more
	(4) Repeating of shield at the repeating of transmission line with indoor unit.	The transmission line is wired with 2-jumper system. Wire the shield with jumper system as same for transmission line. When the jumper wiring is not applied to the shield, the effect against noise will be reduced.
	(5) Are the unit and transmission lines grounded as instructed in the INSTALLATION MANUAL?	Connect to ground as shown in the INSTALLATION MANUAL.
Check for earthing	(6) Earthing of the shield of transmission line (for indoor unit control) to outdoor unit.	One point earthing should be made at outdoor unit. Without earthing, transmission signal may be changed as the noise on the transmission line has no way to escape.
	(7) Arrangement for the shield of transmission line (for centralized control).	For the shield earth of the transmission line for centralized control, the effect of noise can be minimized if it is from one of the outdoor units in case of the group operation with different refrigerant systems, and from the upper rank controller in case the upper rank controller is used. However, the environment against noise such as the distance of transmission line, the number of connecting sets, the type of connecting controller, and the place of installation, is different for the wiring for centralized control. Therefore, the state of the work should be checked as follows. a) No earthing • Group operation with different refrigerant systems One point earthing at outdoor unit • Upper rank controller is used Earthing at the upper rank controller b) Error is generated even though one point earth is being connected. Earth shield at all outdoor units.  Connect to ground as shown in the user's manual.

(b) When the wave height value of transmission wave shape is low, 6607 error is generated, or remote controller is under the state of "HO."

	Items to be checked	Measures to be taken
	(8) The farthest distance of transmission line is exceeding 200m.	Confirm that the farthest distance from outdoor unit to indoor unit/ remote controller is less than 200m.
	(9) The types of transmission lines are different.	Use the transmission wire specified. Type of transmission line : Shield wire CVVS/CPEVS Wire dia. of transmission line : 1.25mm <sup>2</sup> or more
	(10) No transmission power (30V) is being supplied to the indoor unit or the remote control.	a) Check 30V on CNS1, CNS2. b) Remove CNS1 and CNS2 and check resistance is 5-2, 6-2, if not this is a fault. Check main board R3 resistance is 1kΩ±5%, if not this is a fault.
	(11) Faulty indoor unit/remote controller.	Replace outdoor unit circuit board or remote controller.

## 2. MA remote control transmission

The MA remote control and indoor unit communicate with the current tone burst method.

### (1) Symptoms caused by infiltration of noise on transmission cable

If noise, etc., infiltrates the transmission cable and the communication between the MA remote control and indoor unit is cut off for three consecutive minutes, a MA communication error (6831) will occur.

### (2) Confirmation of transmission specifications and waveform

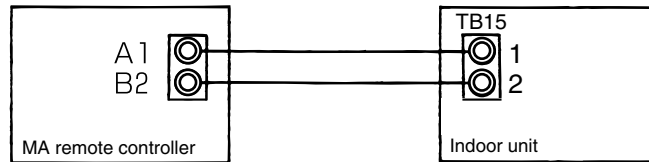

A1, B2: No polarity  
Across terminal No. 1-2 :  
Power supply (8.5V to 12VDC)

Transmission waveform (Across terminal No. 1-2)

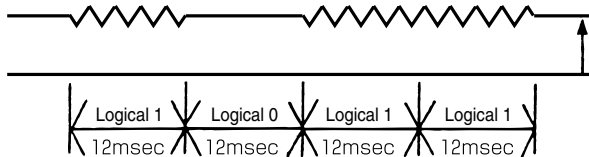

- (1) 2msec/bit  $\pm$  5% must be satisfied
- (2) Voltage across terminal No.1-2 must be within range shown on left.

## [4] Troubleshooting of Principal Parts

### 1. Pressure sensor

#### (1) Check for failure by comparing the sensing pressure according to the high pressure/low pressure pressure sensor and the pressure gauge pressure.

Set SW1 as shown below to display the high and low pressure sensor data displayed digitally by the light emitting diode LD1.



- (1) In the stopped condition, compare the pressure readings from the gauge and from the LD1 display.
  - (a) If the gauge pressure is 0~0.0098MPa, the internal pressure is dropping due to gas leakage.
  - (b) If the pressure according to the LD1 display is 0~0.0098MPa, there is a faulty contact at the connector, or it is disconnected. Proceed to (4).
  - (c) If the pressure according to the LD1 display is 4.15MPa for high pressure or higher, proceed to (3).
  - (d) If other than (a), (b) or (c), compare the pressure readings during operation. Proceed to (2).
- (2) Compare the pressure readings from the gauge and from the LD1 display while in the running condition.
  - (a) If the difference between the two pressures is within 0.098MPa, for high pressure and 0.03MPa for low pressure both the affected pressure sensor and the main MAIN board are normal.
  - (b) If the difference between the two pressures exceeds 0.098MPa, for high pressure and 0.03MPa for low pressure the affected pressure sensor is faulty (deteriorating performance).
  - (c) If the pressure reading in the LD1 display does not change, the affected pressure sensor is faulty.
- (3) Disconnect the pressure sensor from the MAIN board and check the pressure according to the LD1 display.
  - (a) If the pressure is 0~0.098MPa for low pressure on the LD1 display, the affected pressure sensor is faulty.
  - (b) If the pressure is 4.15MPa for high pressure or higher, the MAIN board is faulty.
- (4) Disconnect the pressure sensor from the MAIN board and short out the No. 2 and No. 3 pins of the connector (63HS), then check the pressure by the LD1 display.
  - (a) If the pressure according to the LD1 display is 4.15MPa for high pressure the affected pressure, the affected pressure sensor is faulty.
  - (b) If other than (a), the MAIN board is faulty.

#### (2) Pressure sensor configuration

The pressure sensors are configured in the circuit shown in the figure below. If DC 5V is applied between the red and black wires, a voltage corresponding to the voltage between the white and black wires is output and this voltage is picked up by the microcomputer.

The output voltage is 0.071V/0.098MPa.

※ The pressure sensor on the body side is specified for connector connection.

The connector pin number on the body side is different from that on the main board side.

	Body side	Main board side
Vcc	Pin 1	Pin 3
Vout	Pin 2	Pin 2
GND	Pin 3	Pin 1

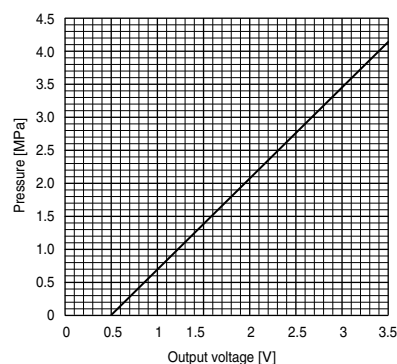
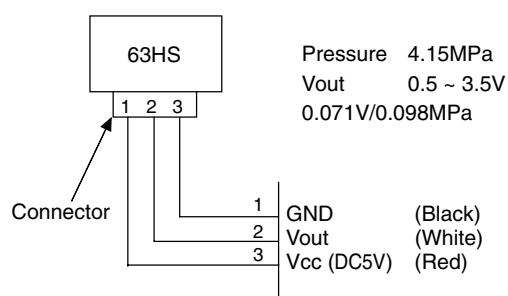



## 2. Low-pressure pressure sensor (63LS)

### (1) Conduct the check comparing the pressure that is detected by the low-pressure pressure sensor and the low-pressure gauge pressure.

The pressure that is detected by the low-pressure pressure sensor will be displayed on the LED screen, LD1 when setting the digital shift switch (SW1) as shown below.



- (1) Compare the gauge pressure and the pressure that is displayed on LD1 while the sensor being stopped.
  - (a) When the gauge pressure is 0~0.098MPa → Inner pressure drop due to gas leak.
  - (b) When the pressure that is displayed on LD1 0~0.098MPa → Contact failure of the connector Check for the contact and proceed to (4).
  - (c) When the pressure that is displayed on LD is 1.7MPa or more → Proceed to (3).
  - (d) When (a), (b), and (c) are not applied, compare the pressure while the sensor is operating. → Proceed to (2).
- (2) Compare the gauge pressure and the pressure that is displayed on LD1 while the sensor is operating. (Compare by MPa unit.)
  - (a) When the difference between the both pressure is within 0.03MPa → Both the low-pressure pressure sensor and the main board are normal.
  - (b) When the difference between the both pressure is over 0.03MPa → The low-pressure pressure sensor is defective (particular deterioration).
  - (c) When the pressure that is displayed on LD1 does not change → The low-pressure pressure sensor is defective.
- (3) Remove the low-pressure pressure sensor from the main board and check the pressure that is displayed on LD1.
  - (a) When the pressure that is displayed on LD1 is 0~0.098MPa → The low-pressure pressure sensor is defective.
  - (b) When the pressure that is displayed on LD1 is approximately 1.7MPa → The main board is defective.
    - When the outdoor temperature is 30°C or less → The main board is defective.
    - When the outdoor temperature is over 30°C → Proceed to (5).
- (4) Remove the low-pressure pressure sensor from the main board, short circuit between the No.2 and No.3 connector (63LS), and check the pressure that is displayed LD1.
  - (a) When the pressure that is displayed on LD1 is 1.7MPa or more → The low-pressure pressure sensor is defective.
  - (b) When (a) is not applied → The main board is defective.
- (5) Remove the high-pressure sensor (63HS) from the main board, insert it into the low-pressure pressure sensor (63LS), and check the pressure that is displayed on LD1.
  - (a) When the pressure that is displayed on LD1 is 1.7MPa or more → The main board is defective.
  - (b) When (a) is no applied → The low-pressure pressure sensor is defective.

### (2) Low-pressure pressure configuration

The low-pressure pressure sensor is composed of the circuit as shown in the right figure. When DC5V is applied between Vcc and GND, the voltage that is appropriate for the pressure between Vout and GND will be output, and it will be taken by the microcomputer.

The output voltage is 0.173V/0.098MPa.

\* The pressure sensor on the body side is specified for connector connection.

The connector pin number on the body side is different from that on the main board side.

	Body side	Main board side
Vcc	Pin 1	Pin 3
Vout	Pin 2	Pin 2
GND	Pin 3	Pin 1

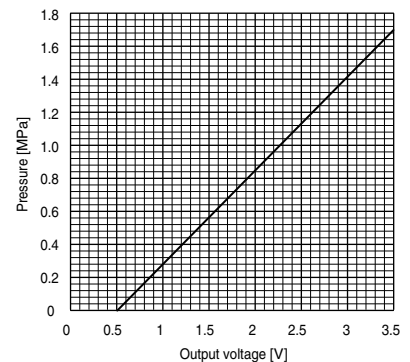
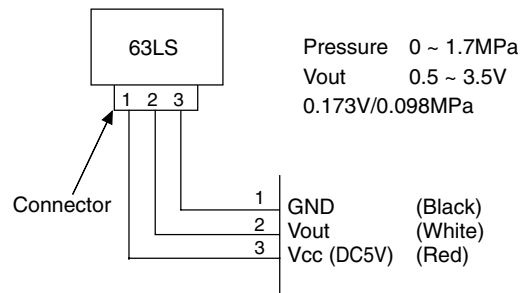

### 3. Solenoid valve

Check if the control board's output signals and the operation of the solenoid valves match.

Setting the self-diagnosis switch (SW1) as shown in the figure below causes the ON signal of each relay to be output to the LED's.

Each LED shows whether the relays for the following parts are ON or OFF. When a LED lights up, it indicates that the relay is ON.

\*The circuit is closed when the relay is ON depending on parts. Refer to the following instructions.

SW1	LED							
	1	2	3	4	5	6	7	8
	21S4a	21S4b	21S4c	CH11	CH12			
	SV1		SV3					
		SV5b	SV5c				52F	

When whatever valves malfunction, check whether the solenoid valve coil is not attached wrongly, the lead wire of the coil is not disconnected, the connector on the board is not inserted wrongly, or the wire for the connector is not disconnected.

#### (1) In the case of SV1 (Bypass valve)

This solenoid valve opens when powered (Relay ON).

- When the compressor starts, SV1 is ON for 4 minutes, check operation by whether the solenoid valve is emitting an operating noise.
- Changes in the operating condition by solenoid valve operation can be confirmed by the temperature of the bypass circuit and the sound of the refrigerant.
- SV1 goes on in accordance with the rise in high pressure in the cooling and heating mode, check operation by LED display and the operating noise emitted by the solenoid valve.

#### (2) In the case of SV3 (Bypass valve) (Only P450-P650 types)

This solenoid valve opens when powered (Relay ON).

The valve is normally powered while No.2 Comp is being stopped.

(When the discharge temperature of No.1 Comp exceeds 110°C, the valve may be turned off.)

To check whether the valve is open or closed, check the change of the SV3 downstream piping temperature while the valve is being powered. When the valve is open, high-temperature gas will run. Do not touch the pipe when checking the temperature.

#### (3) In the case of 21S4a (4-way switching valve)

About this 4-way valve

When not powered : The electricity runs between the oil separator exit and the heat exchanger (in the case of P400 type) HEXB, between heat exchangers at the rear (in the case of P450-P650 types), between HEX1a and 2a (heat exchanger on the right (as you face the front of the unit)), and between the gas ball valve (BV1) and the accumulator. This circulation is for cooling.

When powered : The electricity runs between the oil separator and the gas ball valve, and between the heat exchanger and the accumulator. This circulation is for heating.

Check the LED display and the intake and the discharge temperature for the 4-way valve to check whether the valve has no faults and the electricity runs between where and where.

Do not touch the pipe when checking the temperature, as the pipe on the oil separator side will be hot.

\* Do not give an impact from outside, as the outer hull will be deformed leading to the malfunction of the inner valve.

#### (4) In the case of 21S4b (4-way switching valve)

About this 4-way valve

When not powered : The electricity runs between the oil separator exit and the heat exchanger (in the case of P400 types) HEXB, between heat exchangers at the rear (in the case of P450-P650 types), and between HEX1b and 2b (heat exchanger on the left (as you face the front of the unit)).

When powered : The electricity runs between the heat exchanger and the accumulator, and the valve opens or closes the heat exchanger circuit when cooling or heating.

Check the LED display and the switching sound to check whether the valve has no faults, however, it may be occasionally difficult to check by the sound, as the switching coincides with 21S4a and 21S4c. In this case, check the intake and the discharge temperature for the 4-way valve to check that the electricity runs between where and where.

※1 Do not touch the valve when checking the temperature, as it will be hot.

※2 Do not give an impact from outside, as the outer hull will be deformed leading to the malfunction of the inner valve.

#### (5) In the case of 21S4c (4-way switching valve) (Only P400-P650 types)

About this 4-way valve

When not powered : The electricity runs between the oil separator exit and the heat exchanger (in the case of P400 types) HEXF, between heat exchangers at the front (in the case of P450-P650 types) HEX1a, and between the heat exchangers on the right (as you face the front of the unit).

When powered : The electricity runs between the heat exchanger and the accumulator, and the valve opens or closes the heat exchanger circuit when cooling or heating.

Check the LED display and the switching sound to check whether the valve has no faults, however, it may be occasionally difficult to check by the sound, as the switching coincides with 21S4a and 21S4c. In this case, check the intake and the discharge temperature for the 4-way valve to check that the electricity runs between where and where.

※1 Do not touch the valve when checking the temperature, as it will be hot.

※2 Do not give an impact from outside, as the outer hull will be deformed leading to the malfunction of the inner valve.

#### (6) In the case of SV5b (2-way switching valve)

This valve closes when powered. Check the LED display and the switching sound to check whether the valve has no faults. When cooling, the switching coincides with 21S4b. When it is difficult to check by the sound, check the temperature at the front and the back of the pipe to check whether the refrigerant flows.

※ Do not give an impact from outside, as the outer hull will be deformed leading to the malfunction of the inner valve.

#### (7) In the case of SV5c (2-way switching valve) (Only P400-P650 types)

This valve closes when powered. Check the LED display and the switching sound to check whether the valve has no faults. When cooling, the switching coincides with 21S4c. When it is difficult to check by the sound, check the temperature at the front and the back of the pipe to check whether the refrigerant flows.

※ Do not give an impact from outside, as the outer hull will be deformed leading to the malfunction of the inner valve.

### 4. Outdoor unit fan

- To check the revolution of the fan, check the inverter output state on the LED screen, as the inverter on the outdoor fan controls the revolutions of the fan. The revolution of the fan is approximately 600rpm at full speed.
- When starting the fan, the fan runs at full speed for 5 seconds.
- For the 2 fans for P450-P650 types, the fan on the right (as you face the fan) runs at all times and the fan on the left runs when required. (When heating except for defrost, both fans run.)
- When setting the DIP SW1 to ON  , the inverter output [%] will appear. 100% indicates the full speed and 0% indicates the stop.
- As the revolution of the fan changes under control, at the interphase or when the indoor unit operation capacity is low, the revolution of the fan may change.
- When the fan does not work or an abnormal vibration occurs, the FAN board is defective, or the fan motor runs under open phase or opposite phase. (The microcomputer detects the open phase or the opposite phase of the main power source, however, these malfunctions may occur when doing other service work or when the lead wire for the fan motor is intentionally replaced.)
- When the only one fan is running and the other fans are stopped, check the 52F output state on the LED screen first and check the fan connector and 52F connector misconnection, 52F failure, or the lead wire disconnection.

## 5. LEV

### (1) Indoor LEV

The valve opening angle changes in proportion to the number of pulses.

(Connections between the indoor unit's control board and indoor LEV.)

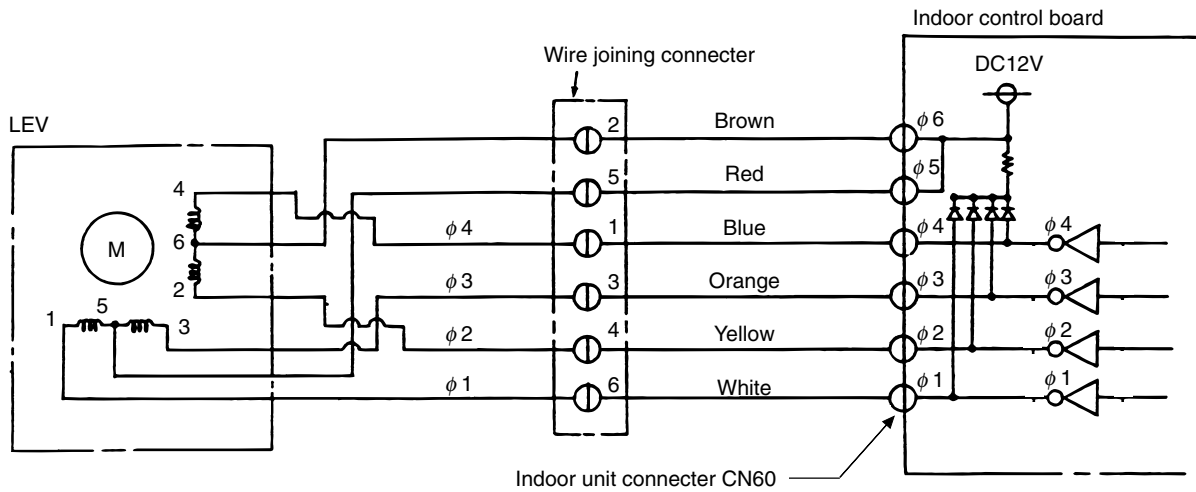

#### Pulse signal output and valve operation

Output (Phase)	Output state			
	1	2	3	4
1	ON	OFF	OFF	ON
2	ON	ON	OFF	OFF
3	OFF	ON	ON	OFF
4	OFF	OFF	ON	ON

Output pulses change in the following orders when the Valve is closed; 1 → 2 → 3 → 4 → 1  
Valve is open; 4 → 3 → 2 → 1 → 4

\*1. When the LEV opening angle does not change, all the output phases are off.

\*2. When the output is out of phase or remains ON continuously, the motor cannot run smoothly, but move jerkily and vibrates.

#### LEV valve closing and valve opening operation

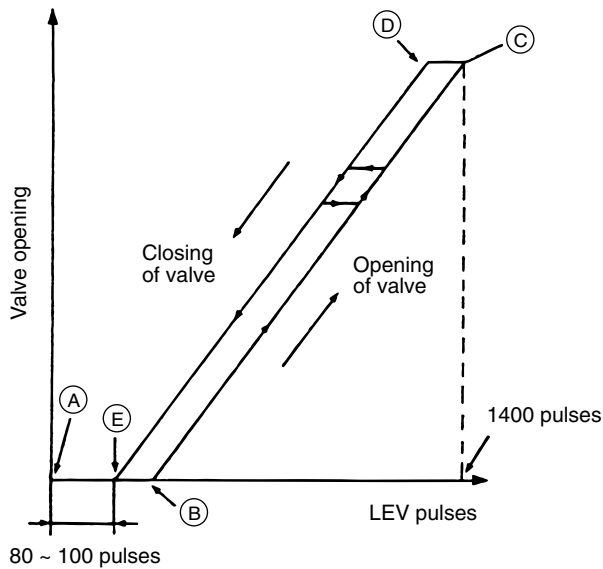

\* When the power is switched ON, a 2200 pulse valve opening signal is output to make sure the valve's position, so that it is definitely at point (A).

\* When the valve operates smoothly, there is no sound from the LEV and no vibration occurs, but when the valve is locked or (E) → (A), it emits a noise .

\* Whether a sound is being emitted or not can be determined by holding a screwdriver, etc. against it, then placing your ear against the handle.

## (2) Outdoor LEV

The valve opening angle changes in proportion to the number of pulses.  
(Connections between the outdoor unit's MAIN board and LEV1.)

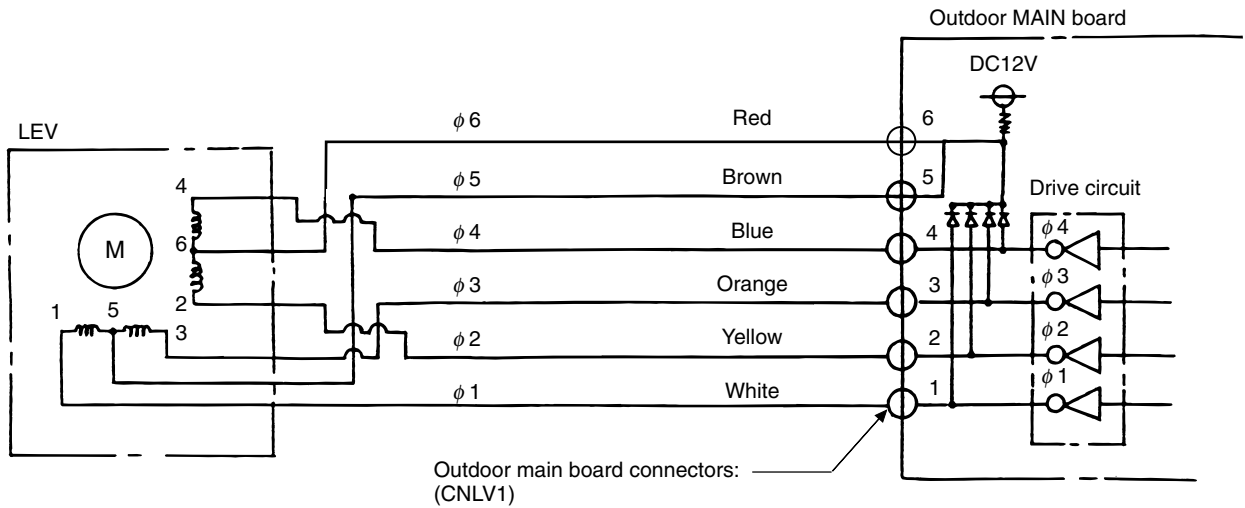

### Pulse signal output and valve operation

Output (Phase)	Output states							
	1	2	3	4	5	6	7	8
φ 1	ON	OFF	OFF	OFF	OFF	OFF	ON	ON
φ 2	ON	ON	ON	OFF	OFF	OFF	OFF	OFF
φ 3	OFF	OFF	ON	ON	ON	OFF	OFF	OFF
φ 4	OFF	OFF	OFF	OFF	ON	ON	ON	OFF

Output pulses change in the following orders when the

Valve is closed; 1 → 2 → 3 → 4 → 5 → 6 → 7 → 8 → 1

Valve is open; 8 → 7 → 6 → 5 → 4 → 3 → 2 → 1 → 8

- \* 1. When the LEV opening angle does not change, all the output phases are off.
- 2. When the output is out of phase or remains ON continuously, the motor cannot run smoothly, but move jerkily and vibrates.

### LEV valve closing and valve opening operation

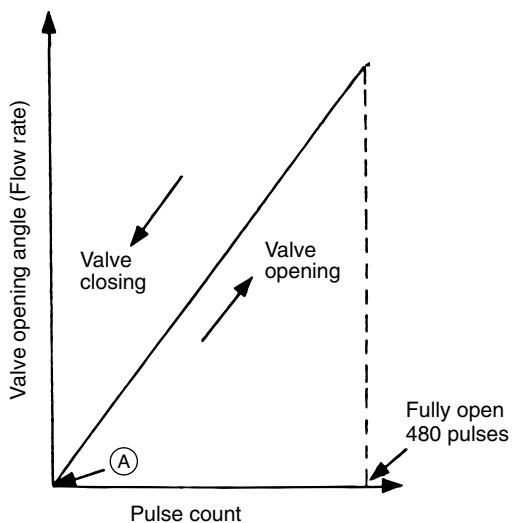

\* When the power is switched ON, a 520 pulse valve opening signal is output to make sure the valve's position, so that it is definitely at point (A). Pulse signal is output for approximately 17 seconds.

\* When the valve operates smoothly, there is no sound from the LEV and no vibration occurs, but when the valve is locked, it emits a noise.

\* Whether a sound is being emitted or not can be determined by holding a screwdriver, etc. against it, then placing your ear against the handle.

\* If there is liquid refrigerant inside the LEV, the sound may become lower.

**(3) Judgment methods and likely failure mode**

**Caution:**

The specifications of the outdoor unit (outdoor LEV) and indoor unit (indoor LEV) differ. For this reason, there are cases where the treatment contents differ, so follow the treatment specified for the appropriate LEV as indicated in the right column.

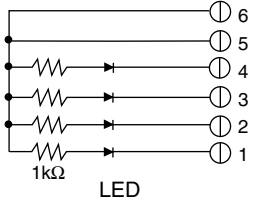
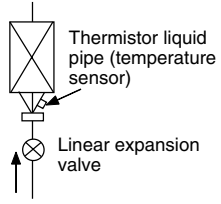
Failure mode	Judgment method	Treatment	Affected LEV
Microcomputer driver circuit failure	<p>1. Disconnect the control board connector and connect the check LED as shown in the figure below.</p>  <p style="text-align: center;">LED</p> <p>When the base power supply is turned on, the indoor LEV outputs pulse signals for 10 seconds, the outdoor LEV outputs pulse signals for 17 seconds. If the LED does not light up, or lights up and remains on, the driver circuit is abnormal.</p>	In the case of driver circuit failure, replace the control board.	Indoor Outdoor
LEV mechanism is locked	<p>1. If the LEV is locked up, the drive motor turns with no load and a small clicking sound is generated. Generation of this sound when the LEV is fully closed or fully open is abnormal.</p>	Replace the LEV.	Indoor Outdoor
The LEV motor coils have a disconnected wire or is shorted	<p>Measure the resistance between the coils (red - white, red - orange, brown - yellow, brown - blue) using a tester. They are normal if the resistance is within <math>150\Omega \pm 10\%</math>.</p>	Replace the LEV coils.	Indoor
	<p>Measure the resistance between the coils (gray - orange, gray - red, gray - yellow, gray - black) using a tester. They are normal if the resistance is within <math>46\Omega \pm 10\%</math>.</p>	Replace the LEV coils.	Outdoor
Fully closed failure (valve leaks)	<p>1. If you are checking the indoor unit's LEV, operate the indoor unit's blower and the other indoor units in the cooling mode, then check the piping temperatures (liquid pipe temperatures) of the indoor units by the operation monitor through the heat source unit's control board. When the fan is running, the linear expansion valve is fully closed, so if there is leakage, the temperature sensed by the thermistor (liquid pipe temperature sensor) will become low. If the temperature is considerably low compared to the remote control's intake temperature display, it can be judged that there is not a fully closed failure. In the case of minimal leakage, it is not necessary to replace the LEV if there are no other effects.</p> 	If there is a large amount of leakage, replace the LEV.	Indoor
Faulty wire connections in the connector or faulty contact.	<p>1. Check for pins not fully inserted on the connector and check the colors of the lead wires visually</p> <p>2. Disconnect the control board's connector and conduct a continuity check using a tester.</p>	Check the continuity at the places where trouble is found.	Indoor Outdoor

**(4) Outdoor LEV coil removal procedure (configuration)**

As shown in the figure, the outdoor LEV is made in such a way that the coils and the body can be separated.

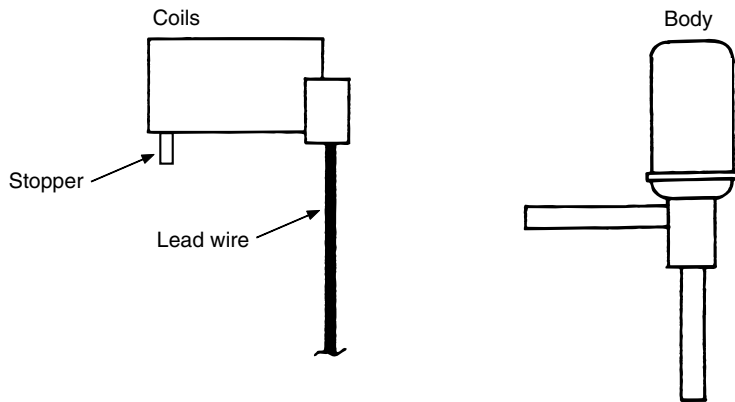

**Removing the coils:**

Fasten the body tightly at the bottom (Part A in the figure) so that the body will not move, then pull out the coils toward the top. If they catch on the stopper and are difficult to take out, turn the coils left and right until the stoppers are free from the stopper indentations, then pull the coils out.

If you take out the coils without gripping the body, undue force may be applied to the piping and the pipe may be bent, be sure to fasten the body in such a way that it will not move.

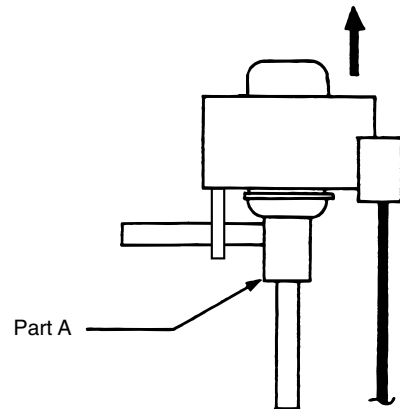

**Installing the coils :**

Fasten the body tightly at the bottom (Part A in the figure) so that the body will not move, then insert the coils from the top, inserting the coils' stopper securely in one of the indentations on the body. (There are four indentations for the stopper on the body around its circumference, and it doesn't matter which indentation is used. However, be careful not to apply undue force to the lead wires or twist them around inside the body.) If the coils are inserted without gripping the body, it may exert undue force on the piping, causing it to become bent, so be sure to hold the body firmly so that it won't move when installing the coils.

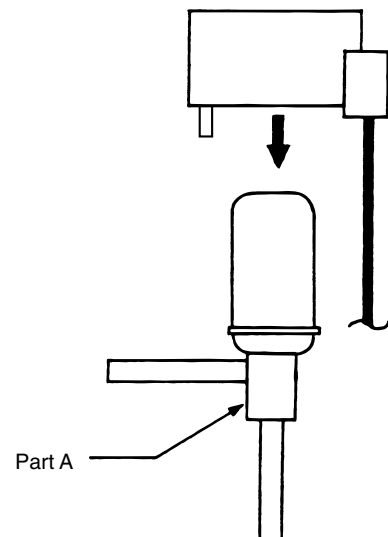

## 6. Inverter and compressor

- a. **Replace only the compressor** if only the compressor is found to be defective.  
(Overcurrent will flow through the inverter if the compressor is damaged, however, the power supply is automatically cut when overcurrent is detected, protecting the inverter from damage.)
- b. Replace the defective components if the inverter is found to be defective.
- c. If both the compressor and the inverter are found to be defective, replace the defective component(s) of both devices.

### (1) Inverter related defect identification and countermeasures

	Error display/failure condition	Measure/inspection item
[1]	Inverter related errors 4250, 4255, 4220, 4225, 4230, 4235, 4240, 4245, 4260, 4265, 5301, 0403, 5110	Check the details of the inverter error in the error log at [9].[1] Check Code List. Perform the measures corresponding to the error code and error details determined using [9].[2] Responding to Error Display on the Remote Controller.
[2]	Main power breaker trip	a. Check the breaker capacity. b. Electrical system short circuit or grounding other than the inverter c. Refer to (3) - [1] if not a, or b.
[3]	Main power earth leakage breaker trip	a. Earth leakage breaker capacity/sensitivity current check b. Meg defect for electrical system other than the inverter c. Refer to (3) - [1] if not a, or b.
[4]	Only the compressor does not operate.	•Check the inverter frequency at the LED monitor and proceed to (2) - [3] if the status is operational.
[5]	The compressor always vibrates strongly or emits an abnormal noise.	Go to (2) - [3].
[6]	Only the fan motor does not operate.	•Check the inverter frequency at the LED monitor and proceed to (2)-[6], [7] if status is operational.
[7]	The fan motor shakes violently at all times or makes an abnormal sound.	•Check the inverter frequency at the LED monitor and proceed to (2)-[6], [7] if status is operational.
[8]	Noise has penetrated the peripheral device	a. Check to ensure that power supply wiring, etc. of the peripheral device is not in close contact with the power supply wiring of outdoor unit. b. Check to ensure that the inverter output wiring is not in close contact with the power supply wiring and transmission lines. c. Check to ensure that the transmission line shield wiring is being used properly in the necessary environment, and that the shield wire ground is appropriate. d. Meg defect for electrical system other than the inverter. e. Attach a ferrite core to the inverter output wiring. (Please contact the factory for details of the service part settings.) f. Change the power to another system. g. If this problem occurs suddenly, there is a possibility that the inverter output is grounded. Proceed to (2) - [3]. • Contact the factory for cases other than those listed above.
[9]	Sudden malfunction (as a result of external noise.)	a. Check to ensure that the unit is grounded. b. Check to ensure that the transmission line shield wiring is being used properly in the necessary environment, and that the shield wire ground is appropriate. c. Check to ensure that the neither the transmission line or external connection wiring run close to another power supply system or run through the same conduct pipe. • Contact the factory for cases other than those listed above.

- Notes: 1. Due to a large capacity electrolytic capacitor used in the inverter, voltage still flows through even after cutting the main power, creating the possibility of electric shock. As a result, wait for a sufficient length of time (5~10 minutes) after cutting the main power and check the voltage at both terminals of the electrolytic capacitor to performing any checks on the inverter.
2. Damage will result to the components of IPM, etc. if the inverter wiring is not properly secured with screws, or if the connector has not been properly inserted. It is likely that any errors occurring after replacing components are the result of wiring mistakes. Ensure that the wiring, screws, connectors and Faston, etc. are properly inserted.
  3. Do not remove or insert inverter connectors with the main power supply on, as this will result in damage to the PCB.
  4. The current sensor will be damaged if current flows without connecting to the PCB. Always insert connectors into the corresponding PCB when running the inverter.



## (2) Treatment of inverter output related troubles

	Check item	Phenomena	Treatment
[1] Check the INV board error detection circuit.	Perform the following: 1. Disconnect INV board CNDR2. After removing, turn on the outdoor unit and check the error status. (The compressor does not operate because CNDR2, which carries the IPM drive signal, has been disconnected.)	(1) IPM/overcurrent error. (4250 detailed No. 101, 102, 103, 104, 105, 106, 107)	• Replace the INV board.
		(2) Logic error (4250 detail No.111)	• Replace the INV board.
		(3) ACCT sensor circuit error. (5301 detailed No. 115)	See to [9].[4].6.(4) "Current Sensor ACCT" Check the resistance and replace if erroneous. Replace the INV board if the ACCT status is normal.
		(4) DCCT sensor circuit error. (5301 detailed No. 116)	• Replace the DCCT After replacing the DCCT, operate the outdoor unit again. In the case when the error occurs again, replace the INV board. (The DCCT may be no problem.)
		(5) IPM open error (5301 detail No.119)	• Normal
[2] Check for compressor ground fault or coil error.	Disconnect the compressor wiring, and check the compressor Meg, and coil resistance.	(1) Compressor Meg failure Error if less than 1MΩ. •When no refrigerant is accumulated in the compressor. (2) Compressor coil resistance failure Coil resistance value of 0.16Ω (20°C)	• Replace compressor Check whether the refrigerant is accumulating in the compressor again.
[3] Check to see if the inverter is damaged. •Perform this check if an error occurs immediately before or after turning on the compressor.	Perform the following: 1. Reconnect the connector removed at item [1]. 2. Disconnect the compressor wiring. 3. Turn on SW1-1 on the INV board. Operate the outdoor unit after above steps. Check the inverter output voltage. •It is recommend to use the test rused to determine the [9].[4].6.(5) IPM troubleshooting when checking the inverter output voltage. •Measure when the inverter output frequency is stable.	(1) IPM/overcurrent error. (4250 detailed No. 101, 102, 103, 104, 105, 106, 107)	• Refer to item [5] for inverter circuit trouble.
		(2) There is a high possibility of an inverter circuit error if the voltage unbalance across all wiring is greater than the larger of the values represented by 5% or 5V.	
		(3) No voltage unbalance across all wiring	See item [2]. Proceed to item [5] however if there is no problem at [2]. Replace the compressor if there is no problem at [5].
[4] Check to see if the inverter is damaged. •Perform this check if an error occurs during steady operation.	Turn on the outdoor unit. Check the inverter output voltage. •It is recommend to use the test rused to determine the [9].[4].6.(5) IPM troubleshooting when checking the inverter output voltage. •Measure when the inverter output frequency is stable.	(1) There is a high possibility of an inverter circuit error if the voltage unbalance across all wiring is greater than the larger of the values represented by 5% or 5V.	• Refer to item [5] for inverter circuit trouble.
		(2) No voltage unbalance across all wiring	See item [2]. Proceed to item [5] however if there is no problem at [2]. Replace the compressor if there is no problem at [5].

	Check item	Phenomena	Treatment	
[5] Check the inverter circuit trouble.	1. Check to see if the IPM screw terminal is loose.	(1) Screw terminal is loose.	Check all IPM screw terminals and tighten.	
	2. Check the exterior of the IPM.	(2) IPM is cracked due to swelling.	<ul style="list-style-type: none"> <li>• IPM replacement</li> </ul> Check the operation in [3] or [4] after replacing the IPM. In the case of an output voltage unbalance or error recurrence: →Replace the G/A board In the case of an output voltage unbalance or error recurrence after replacement: →Replace the INV board	
	3. Check the resistances between each terminal of IPM. Refer to 9.[4].6.(5) for details on IPM troubleshooting.	(3) Resistance error between each terminal of IPM.	<ul style="list-style-type: none"> <li>• IPM replacement</li> </ul> Check the operation in [3] or [4] after replacing the IPM. In the case of an output voltage unbalance or error recurrence: →Replace the G/A board In the case of an output voltage unbalance or error recurrence after replacement: →Replace the INV board	
		(4) All normal for items (1) ~ (3) above.	<ul style="list-style-type: none"> <li>• IPM replacement</li> </ul> In the case of an output voltage unbalance or error recurrence after replacement: →Replace the G/A board In the case of an output voltage unbalance or error recurrence after replacement: →Replace the INV board	
[6] Check the fan motor grounding fault and the winding.	Remove the wire for the outdoor fan motor and check the fan motor megger and the winding resistance.	(1) Fan motor megger fault Fault when the megger is 1Ω or less.	Replace the fan motor.	
		(2) Fan motor disconnection Standard: The winding resistance is approximately several Ω. (It varies depending on the temperature or while the inner thermo is operating, it will be ∞Ω.)		
[7] Check the FAN board failure.	1. Check around the fan output wiring.	Connector contact failure 1) Board side (CNINV) 2) Fan motor side	Connect the connector	
	2. Check the connector CNVDC connection	Connector contact failure	Connect the connector	
	3. Check the FAN board failure.	(1) The voltage unbalance among each motor. (The voltage unbalance is greater than the larger of the values represented by 5% or 5V.)	(2) The same error occurs even if operated again.	Replace the FAN board.
4. Check the transformation of the FAN board.	The same error occurs even if the board is replaced as described in 3.	Replace the power-supply transformation for FAN board.		

### (3) Trouble measures when main power breaker tripped

	Check item	Phenomena	Treatment
[1]	Perform Meg check between the terminals in the power terminal block TB1.	(1) Zero to several ohm, or Meg failure.	Check each part in the main inverter circuit. • Refer to "Simple checking Procedure for individual components of main inverter circuit". a. Diode Stack b. IPM c. Rush current protection resistor d. Electromagnetic relay e. DC reactor f. Noise filter
[2]	Turn on the power again and check once more.	(1) Main power breaker trip (2) No remote control display	
[3]	Turn on the outdoor unit and check that it operates normally.	(1) Operates normally without tripping the main breaker. (2) Main power breaker trip	a. There is a possibility that the wiring shorted momentarily. Trace the short and repair. b. If a. above is not the case, there is a possibility that there was a compressor failure. • A compressor ground fault can be considered. Go to (2) - [2].

### (4) Simple checking procedure for individual components of main inverter circuit

\* Before checking, cut the power off and remove the required parts from the control box.

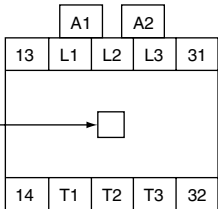
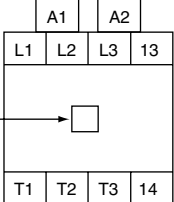
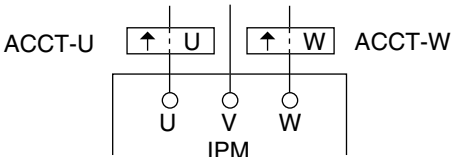
Part name	Judgement method																												
Diode stack	Refer to "Determining diode stack troubleshooting" ( [9].[4].6.(6) )																												
IPM (Intelligent power module)	Refer to "Determining IPM interference" ( [9].[4].6.(5) )																												
Rush current protection resistor R11, R12	Measure the resistance between terminals: $47\Omega \pm 10\%$																												
Electromagnetic contactor (52C1, 52C2, 52F)	<p>[In the case of 52C1, 52C2]</p>  <p>[In the case of 52F]</p>  <table border="1" style="margin-left: 20px;"> <thead> <tr> <th colspan="2">Checking position</th> <th>Judgement value</th> </tr> </thead> <tbody> <tr> <td colspan="2">A1-A2</td> <td>0.1k~2.0kΩ</td> </tr> <tr> <td rowspan="5">Button ON (pushdown)</td> <td>L1-T1</td> <td>1Ω or less (Almost 0Ω)</td> </tr> <tr> <td>L2-T2</td> <td>//</td> </tr> <tr> <td>L3-T3</td> <td>//</td> </tr> <tr> <td>13-14</td> <td>//</td> </tr> <tr> <td>31-32</td> <td>∞</td> </tr> <tr> <td rowspan="5">Button OFF</td> <td>L1-T1</td> <td>∞</td> </tr> <tr> <td>L2-T2</td> <td>//</td> </tr> <tr> <td>L3-T3</td> <td>//</td> </tr> <tr> <td>13-14</td> <td>//</td> </tr> <tr> <td>31-32</td> <td>1Ω or less (Almost 0Ω)</td> </tr> </tbody> </table>	Checking position		Judgement value	A1-A2		0.1k~2.0kΩ	Button ON (pushdown)	L1-T1	1Ω or less (Almost 0Ω)	L2-T2	//	L3-T3	//	13-14	//	31-32	∞	Button OFF	L1-T1	∞	L2-T2	//	L3-T3	//	13-14	//	31-32	1Ω or less (Almost 0Ω)
Checking position		Judgement value																											
A1-A2		0.1k~2.0kΩ																											
Button ON (pushdown)	L1-T1	1Ω or less (Almost 0Ω)																											
	L2-T2	//																											
	L3-T3	//																											
	13-14	//																											
	31-32	∞																											
Button OFF	L1-T1	∞																											
	L2-T2	//																											
	L3-T3	//																											
	13-14	//																											
	31-32	1Ω or less (Almost 0Ω)																											
DC reactor DCL	Measure the resistance between terminals: 1Ω or lower (almost 0Ω) Measure the resistance between terminals and the chassis : ∞																												
Current sensor ACCT	<p>Disconnect the CNCT2 target connector and check the resistance between terminals: <math>280\Omega \pm 30\Omega</math> 1-2PIN (U-phase) 3-4PIN (W-phase)</p>  <p style="text-align: right;">* Check the ACCT connecting phase and direction.</p>																												

## (5) Intelligent power module (IPM)

Measure resistances between each terminal of IPM with tester, and use the results for troubleshooting

Notes on measurement

- Make sure the polarity before the measurement. (On the tester, black normally indicates plus.)
- Make sure that the resistance is not open ( $\infty\Omega$ ) or not shorted (to  $0\Omega$ ).
- For the resistance, the margin of error is allowed.
- The result that is more than double or half than the result that is measured at the same measurement point is not allowed.

### Tester restriction

- **Use the tester whose internal electrical power source is 1.5V or greater.**
- **Use the dry-battery-powered tester.**  
(※The accurate diode-specific resistance cannot be measured with the button-battery-powered card tester, as the applied voltage is low.)
- **Use the range that measures low resistance as much as possible.**  
The more accurate resistance can be measured.

#### • External view

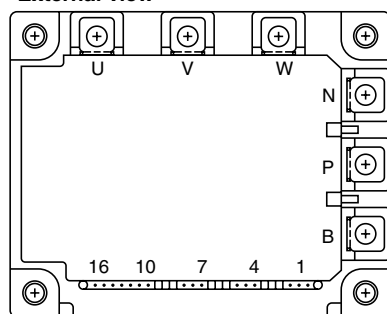

#### • Internal circuit diagram

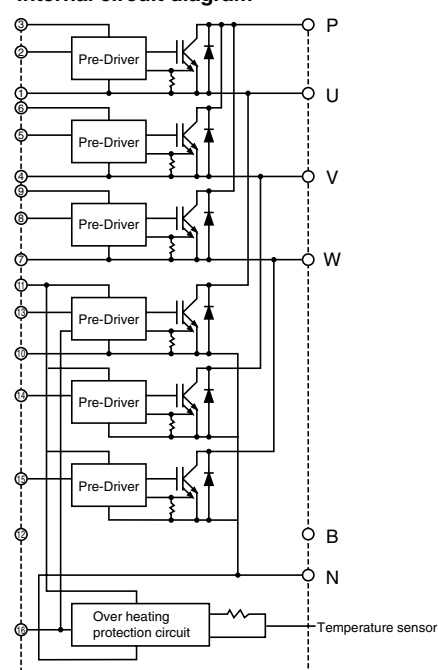

#### • Judgement value

Black (+) \ Red (-)	P	N	U	V	W
P	-	$\infty$	5~200 $\Omega$	5~200 $\Omega$	5~200 $\Omega$
N	$\infty$	-	$\infty$	$\infty$	$\infty$
U	$\infty$	5~200 $\Omega$	-	-	-
V	$\infty$	5~200 $\Omega$	-	-	-
W	$\infty$	5~200 $\Omega$	-	-	-

## (6) Diode stack

Measure resistances between each terminal of diode stack with tester, and use the results for troubleshooting. Refer to (5) "Intelligent power module (IPM)" for notes on measurement and tester restriction.

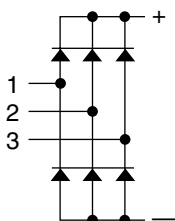
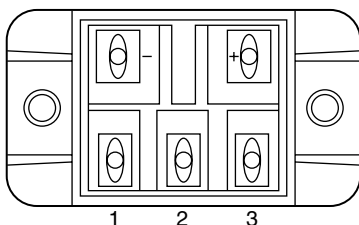

#### • Judgement value

Black (+) \ Red (-)	+ (P)	- (N)	~ (1)	~ (2)	~ (3)
+ (P)	-	$\infty$	5~200 $\Omega$	5~200 $\Omega$	5~200 $\Omega$
- (N)	$\infty$	-	$\infty$	$\infty$	$\infty$
~ (1)	$\infty$	5~200 $\Omega$	-	-	-
~ (2)	$\infty$	5~200 $\Omega$	-	-	-
~ (3)	$\infty$	5~200 $\Omega$	-	-	-

**(7) Caution at replacement of inverter parts**

(1) Fully check wiring for incorrect and loose connection.

The incorrect or loose connection of the power circuit part wiring like IPM and diode module causes to damage the IPM. Therefore, check the wiring fully. As the insufficient tightening of screws is difficult to find, tighten them together additionally after finishing other works. For the wiring of the base for IPM, observe the wiring diagram below carefully as it has many terminals.

(2) Coat the grease for radiation provided uniformly onto the radiation surface of IPM /diode modules.

Coat the grease for radiation on the full surface in a thin layer, and fix the module securely with the screw for fastening. As the radiation grease attached on the wiring terminal causes poor contact, wipe it off if attached.

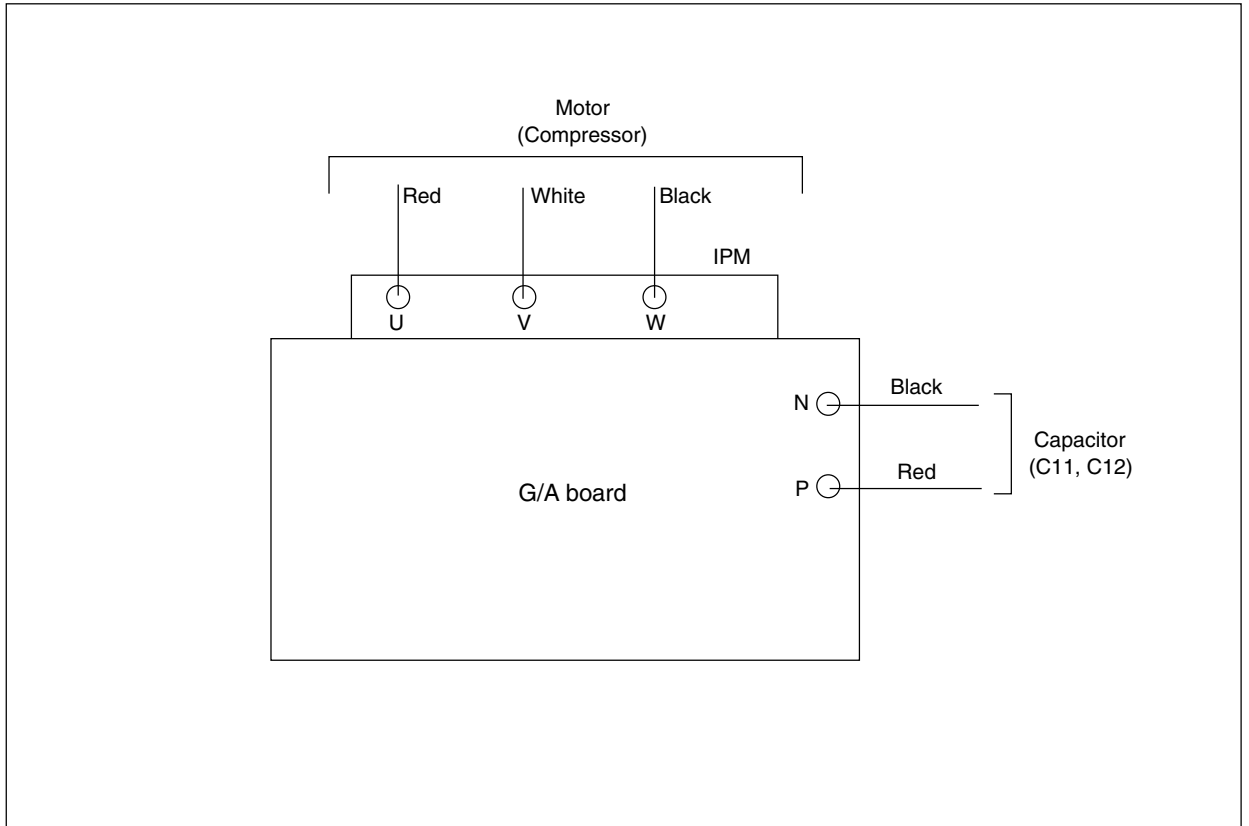

## 7. Control circuit

### (1) Control power source function block

[ P200~P400 types ]

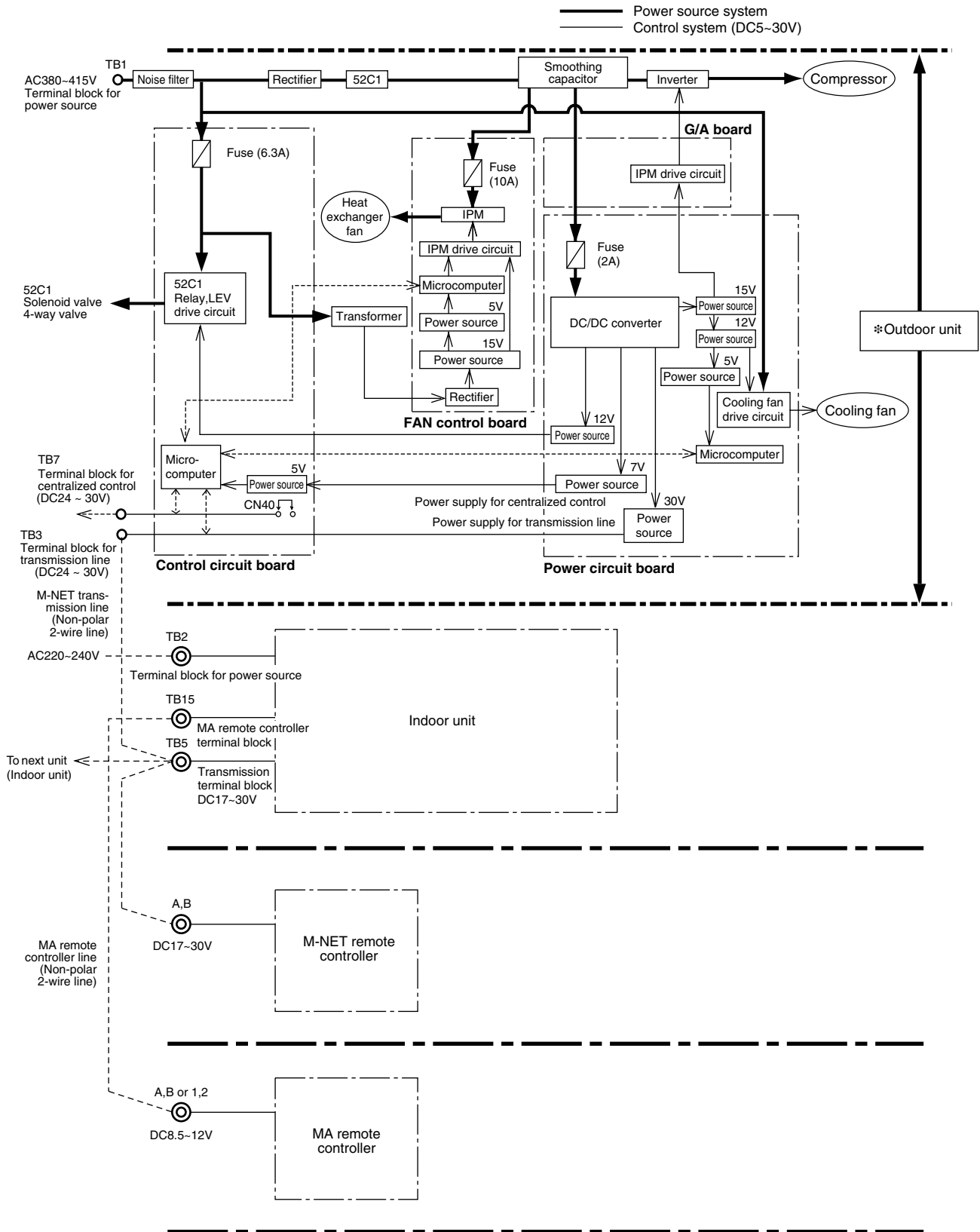

\* M-NET remote controller and MA remote controller can not be used together.

[ P450~P650 types ]

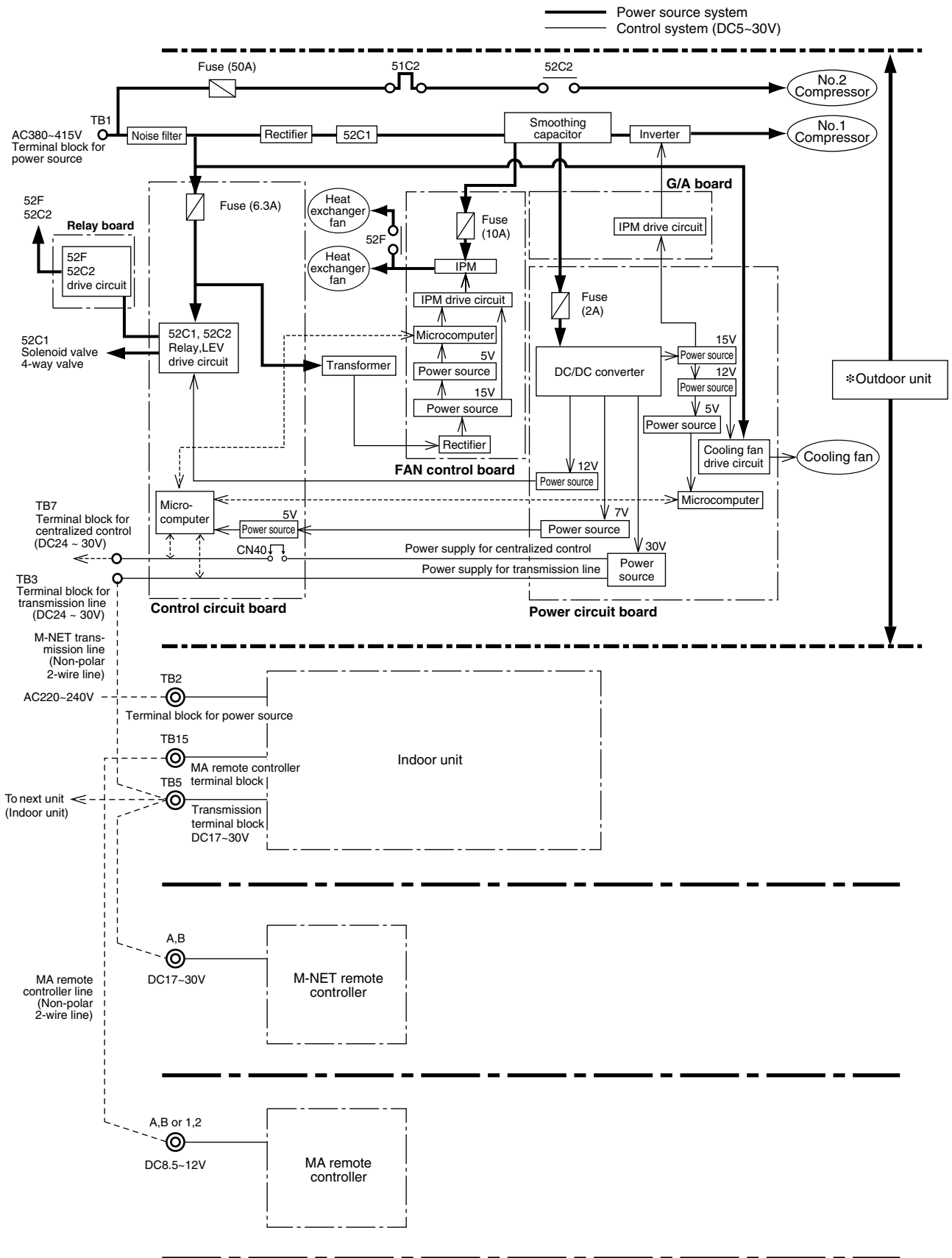

\* M-NET remote controller and MA remote controller can not be used together.

(2) Outdoor unit transmission power source circuit failure judgment

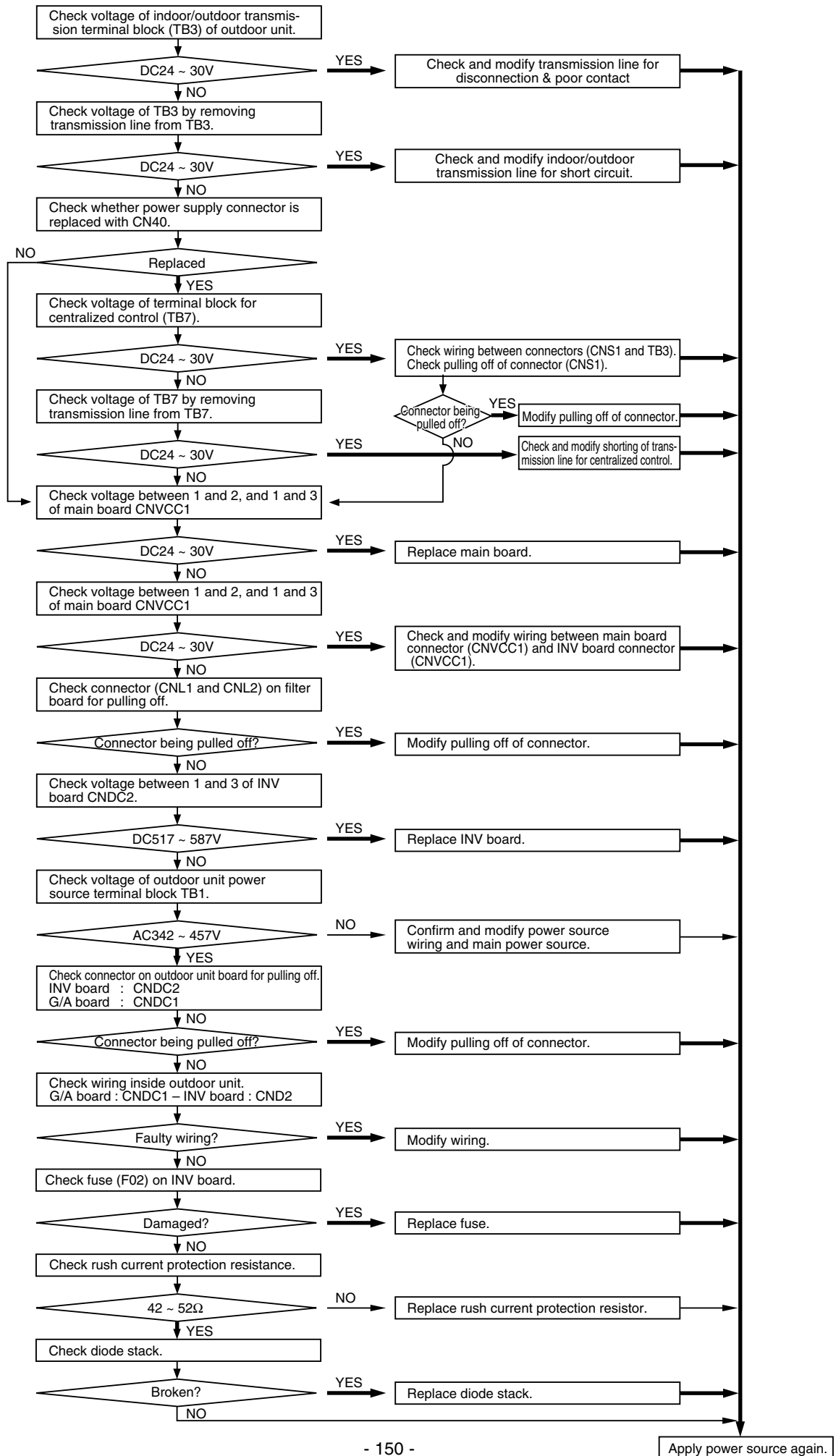



## [5] Refrigerant Leak

### 1. Leak spot: In the case of extended pipe for indoor unit (Cooling season)

- ① Mount a pressure gauge on the check joint (CJ2) for low-pressure service.
- ② Stop all the indoor units, and close the liquid ball valve (BV2) inside the outdoor unit while the compressor is being stopped.
- ③ Stop all the indoor units; turn on SW3-6 on the outdoor unit main board while the compressor is being stopped. (Pump down mode will start, and all the indoor unit will perform a test run in cooling mode.)
- ④ Under the pump down mode (SW3-6 is ON), the low-pressure pressure (LPS) becomes 0.382MPa or less, or all the indoor units automatically stop in 15 minutes after the pump mode starts.  
When the value of the pressure gauge, which is on the check joint (CJ2) for low-pressure service, is 0.284MPa or when 20 minutes pass, stop all the indoor units and the compressor.
- ⑤ Close the gas ball valve (BV1) inside the outdoor unit.
- ⑥ Wipe the refrigerant that remains in the extended pipe for the indoor unit.  
Do not discharge refrigerant into air into the atmosphere when it is collected.
- ⑦ Repair the leak.
- ⑧ After repairing the leak, vacuum the extended pipe for the indoor unit.
- ⑨ To adjust refrigerant, open the ball valves (BV1 and BV2) inside the outdoor unit and turn off SW3-6.

### 2. Leak spot: In the case of outdoor unit (Cooling season)

- ① Conduct a test run for all the indoor units under the cooling mode.
  - (1) To start a test run for all the indoor units, turn on SW3-2 when SW3-1 on the outdoor unit main board is ON.
  - (2) Change the setting of the remote controller for all the indoor units to the cooling mode.
  - (3) Check that all the indoor units are performing a cooling operation.
- ② Check the values of Tc and TH7.  
(To display the values on the LED screen, use the self-diagnosis switch (SW1) on the outdoor unit main board.)
  - (1) When Tc-TH7 is 10K or more .... See the next item ③.
  - (2) When Tc-TH7 is less than 10K .... After the compressor stops, wipe the refrigerant inside the system, repair the leak, perform evacuation, and recharge new refrigerant.  
(Leak spot: In the case of outdoor unit, handle in the same way as heating season.)

[ Tc self-diagnosis switch ]



[ TH7 self-diagnosis switch ]

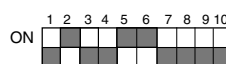

- ③ Stop all the indoor units, and stop the compressor.
  - (1) To stop all the indoor units and the compressor, turn off SW3-2 when SW3-1 on the outdoor unit main board is ON.
  - (2) Check that all the indoor units are being stopped.
- ④ Close the ball valves (BV1 and BV2).
- ⑤ **To prevent the liquid seal, extract small amount of refrigerant from the check joint of the liquid ball valve (BV2), as the liquid seal may cause a malfunction of the unit.**
- ⑥ Collect the refrigerant that remains inside the outdoor unit. Do not discharge refrigerant into air into the atmosphere when it is collected.
- ⑦ Repair the leak.
- ⑧ After repairing the leak, replace the dryer with the new one, and perform evacuation inside the outdoor unit.
- ⑨ To adjust refrigerant, open the ball valves (BV1 and BV2) inside the outdoor unit.

Note : When the power for the outdoor/indoor unit must be turned off to repair the leak after closing the ball valves specified in the item ④, **turn the power off in approximately one hour after the outdoor/indoor units stop.**

- a) If the power for the outdoor unit is turned off within 30 minutes after the item ④,
  - When the stop mode continues for 30 minutes in a row, the indoor unit LEV turns from fully closed to faintly open to prevent the liquid seal inside the liquid pipe. Therefore, when the power for the indoor unit is turned off within 30 minutes after the outdoor unit stops, liquid will be sealed.
- b) Even if the outdoor unit LEV turns from fully closed to faintly open within 30 minutes after the outdoor unit stops, do not turn off the power for indoor/outdoor unit until the refrigerant inside the liquid pipe discharges into the indoor unit and into the gas pipe.
  - When only the power for the indoor unit is turned off, the indoor unit LEV turns from faintly open to fully closed.

### 3. Leak spot: In the case of extended pipe for indoor unit (Heating season)

- ① Conduct a test run for all the indoor units under the heating mode.
  - (1) To start a test run for all the indoor units, turn on SW3-2 when SW3-1 on the outdoor unit main board is ON.
  - (2) Change the setting of the remote controller for all the indoor units to the heating mode.
  - (3) Check that all the indoor units are performing a heating operation.
- ② Stop all the indoor units, and stop the compressor.
  - (1) To stop all the indoor units and the compressor, turn off SW3-2 when SW3-1 on the outdoor unit main board is ON.
  - (2) Check that all the indoor units are being stopped.
- ③ Close the ball valves (BV1 and BV2).
- ④ Collect the refrigerant that remains inside the outdoor unit. Do not discharge refrigerant into air into the atmosphere when it is collected.
- ⑤ Repair the leak.
- ⑥ After repairing the leak, perform evacuation of the extended pipe for the indoor unit, and open the ball valves (BV1 and BV2) to adjust refrigerant.

### 4. Leak spot: In the case of outdoor unit (Heating season)

- ① Collect the refrigerant in the entire system (outdoor unit, extended pipe and indoor unit). Do not discharge refrigerant into the atmosphere when it is collected.
- ② Repair the leak.
- ③ After repairing the leak, replace the dryer with the new one, and perform evacuation of the entire system, and calculate the standard amount of refrigerant to be added (for outdoor unit, extended pipe and indoor unit), and charge the refrigerant. For the amount of refrigerant, refer to [8].[4].3.

## [6] Compressor Replacement Instructions (only P450-P650 types)

Follow the instructions below when replacing the compressor.

When replacing the compressor No.1 (inverter drive), start replacing after judging whether the compressor is malfunctioning or the inverter is malfunctioning. When only one compressor is malfunctioning, operate the compressor for approximately an hour under emergency operation mode before the replacement, check the items below, and replace the compressor after examining whether the return oil circuit is working properly or not.

Refer to the right chart for the temperature of each part.

< When normal >

- ① Temperature of A = Temperature of C, and  
Temperature of A > Outdoor temperature + 10deg
- ② Temperature of B = Temperature of C, and  
Temperature of B > Outdoor temperature + 10deg

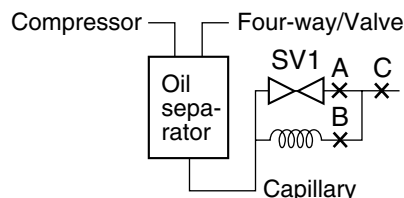

< When abnormal >

When ① is abnormal (out of range)

Return oil failure due to SV1 circuit failure → Replace SV1 circuit.

When ② is abnormal (out of range)

Return oil failure due to capillary blockage → Replace the capillary

- (1) Make sure that the main power is OFF.

When replacing the compressor due to megger fault and the megger is  $1\Omega$  or more, megger drop is likely due to the liquified refrigerant gas entering and accumulating in the compressor. Turn the power off after powering the crankcase heater at least 12 hours, and apply megger again.

- (2) Remove the fin guard, the front panel and the front partition plate on the right (as you face the front).

- (3) Drain the refrigerant from the check joint for high and low-pressure service.

When collecting refrigerant from the accumulator, perform proper work with the reference of the liquid refrigerant collecting method from the accumulator.

- (4) Drain the refrigerating machine oil from the drain oil pipe that is located on the equal oil pipe.

Note : When draining the oil, prepare an approximately 10-liter container.

Note : Keep draining oil until the oil in the drain oil plug clears up.

Note : Keep track of the amount of drained oil, as the same amount of oil will be added.

Note : Do not splash oil.

Note : Do not leave the refrigerant circuit open for a long time, as the oil rapidly absorbs moisture.

Note : The drained oil cannot be recycled.

- (5) After draining oil from the refrigerant and the drain oil plug, remove the metal fitting-1 or the flare nuts (2 places) that connect the compressor and the equal oil pipe, and bend the equal oil pipe so as not to apply an excess force.

- (6) Close the equal oil pipe attachment point with a cap to prevent the oil from leaking.

- (7) Remove the compressor terminal cover, and remove the power supply wiring.

- (8) Remove the sound-proof material that is winded around the discharge temperature thermistor and the compressor.

- (9) Remove the crankcase heater.

- (10) Heat the brazing part of the discharge pipe and the suction pipe, and remove the pipes.

- (11) Remove the compressor fixing nut and the metal fitting-2 (3 places for compressor-2).

- (12) Replace the compressor with the service compressor.

- (13) Braze the discharge pipe and the suction pipe.

- (14) Attach the equal oil pipe to both compressors. Replace the dryer with the new one. After replacing the dryer, do not leave the refrigerant circuit open for long time.

Note : When replacing the compressor and when the equal oil pipe is damaged or irreparably deformed, after replacing the compressor, heat the junction of the equal oil pipe, remove the equal oil pipe, and braze the service equal oil pipe.

- (15) Close the ball valves in the outdoor unit (both on the liquid and the gas side), and pressurize up to 4.15MPa with nitrogen from the check joint for high and low-pressure service.

- (16) After confirming the airtightness, emit nitrogen gas.

- (17) Open the ball valves in the outdoor unit (both on the liquid and the gas side), and perform vacuuming.

- (18) While vacuuming, add the same amount of oil that is drained from the drain oil plug on the equal oil pipe in the procedure (4).

Note : The oil to be added must be MEL32 made by Nisseki Mitsubishi. When adding oil, the oil must not absorb moisture, and do not use the oil that is over a year old.

Note : Do not drain the oil in the compressor and return the oil, as it will be used to examine for reasons for the compressor malfunction.

- (19) Attach the crankcase heater.  
Note : Attach the appropriate crankcase heater to the appropriate compressor.
- (20) Attach the soundproof material to the compressor.
- (21) Attach the discharge temperature themistor, and attach the insulation cover.
- (22) Attach the power source wire to the terminal on the compressor.
- (23) After vacuuming, calculate the amount of added refrigerant at factory shipment and the amount of added refrigerant on site, and charge the system.
- (24) After reconfirming the power source-wiring phase, apply a megger, attach the terminal cover, turn on the main power, and check whether the crankcase heater is powered.
- (25) Check that the ball valves (both on the liquid and the gas side) are open.
- (26) Operate all the indoor units, and check whether they run properly.
- (27) If there is something that needs to be improved in the installation or the usage, explain that to the customers.

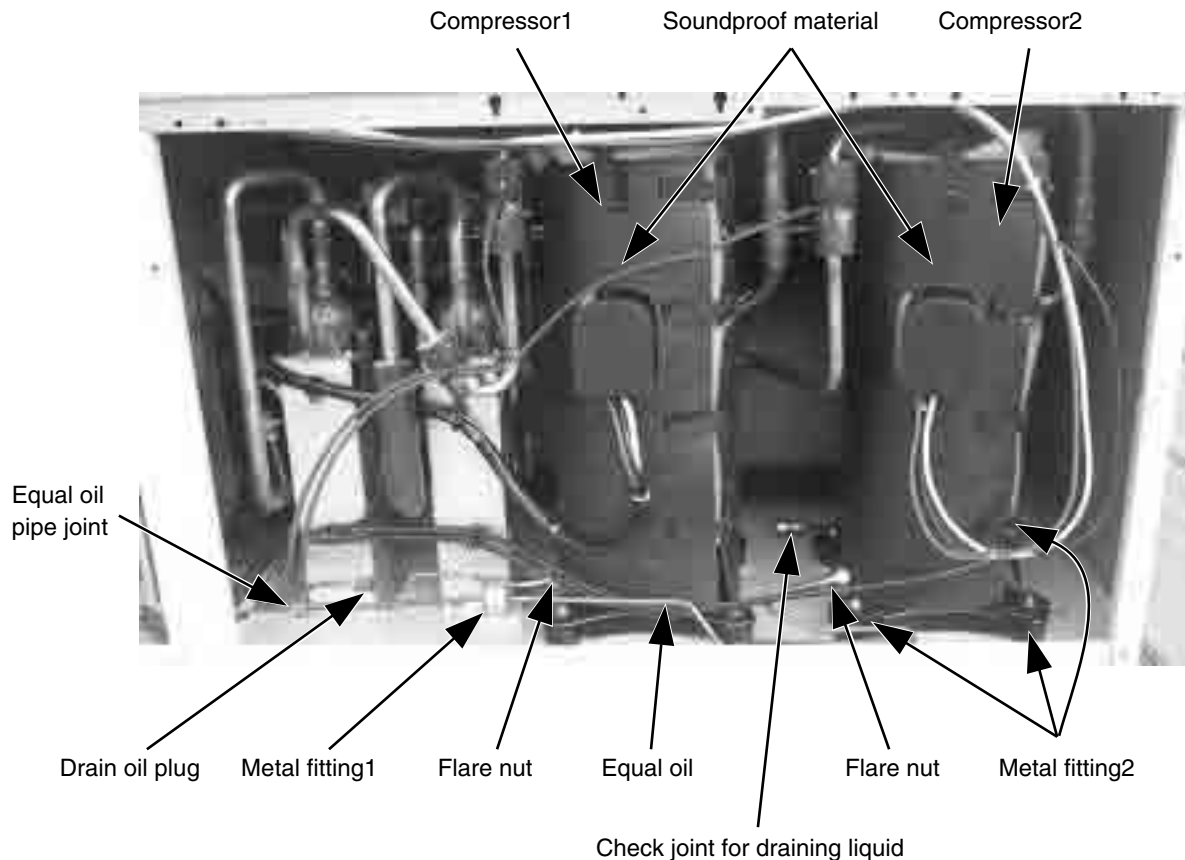

### [7] Collecting the Cooling Liquid from the Accumulator (Only P450-P650 types)

- (1) Perform evacuation inside the recovery cylinder.
- (2) Connect the check joint for collecting liquid that is derived from the accumulator and the recovery cylinder with a connection pipe (or hose that has predetermined withstand pressure).  
Note : When connecting the check joint and the connecting pipe (hose), extremely low-temperature oil may flow out. Use some protective equipment, such as leather gloves.
- (3) Open the valves of the recovery cylinder while the recovery cylinder is being weighed, and collect the liquid inside the accumulator into the cylinder.  
Note : Allow some capacity when collecting the liquid so that the recovery cylinder will not be flooded. Use several cylinders when collecting large amount of liquid.
- (4) After collecting the liquid, close the valve of the recovery cylinder, and remove the connecting pipe (hose).  
Note : When removing the check joint and the connecting pipe (hose), extremely low-temperature oil may flow out. Use some protective equipment, such as leather gloves.
- (5) Charge 3-liter oil from the check joint of the accumulator during evacuation.

## 10 LED display

### [1] LED Monitor Display

#### 1. How to read LED for service monitor

By setting of DIP SW1-1 ~ 1-10, the unit operating condition can be observed with the service LED on the control circuit board. (For the relation of each DIP SW to the content, see the table provided.)

As shown in the figure below, the LED consist of 7 segments is put in 4 sets side by side for numerical and graphic display.

OC : Outdoor unit	SV : Solenoid valve	THHS : Inverter radiator panel
IC : Indoor unit L	EV : Electronic expansion valve	Th : Thermistor
	COMP : Compressor	
SW1 : Outdoor unit control circuit board		
E : Memory storage for service activities (sampling per minute)		

7 seg LED

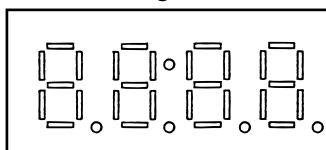

The numerical display includes that of pressure, temperature or the like, while the graphic display includes that of operating condition, solenoid valve ON/OFF state or the like.

- Numerical display

Example : Display at 18.8kg/cm<sup>2</sup>G (1.84MPa) of pressure sensor data (Item No. 72)

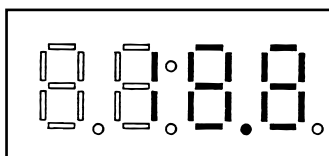

- Graphic display (Two LEDs aligned vertically express a flag.)

Example : At forcible powering in outdoor unit operation display (Item No. 14)

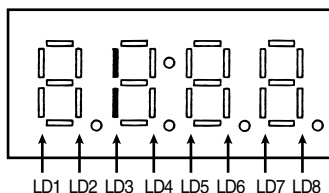

#### 2. LED display at initial setting

After turning the power on, the following model information will be displayed until the initial setting is done.

(Repeat No① → ② → ③ → ④)

No	SW1	Item	Display	Remark
①	Irrelevant	Software version	8888	[0103] ..... Version1.03
②		Refrigerant type	888	[ 410] ..... R410A
③		Unit type & capacity	888	[C-08] ..... PUY 8 horsepower [H-20] ..... PUHY 20 horsepower [r-10] ..... PURY 10 horsepower
④		M-NET address	888	[ 51] ..... 51 address

This LED display can be seen after the initial setting when No517, monitor display, setting is made.

### 3. Time data storage function

※ This function is not compatible with some units.

The outdoor unit has a simple clock function to receive the time setting from the system controller, such as the G50A, and count the current time with an internal timer.

If an error (prediction) occurs, the error history data and the error detection time are saved in the service memory.

The error detection time saved in the service memory and the current time can be confirmed with the service LEDs.

Notes: 1. This is a simple clock function so the time should be used only for reference.

2. The date and time data is all set to 00 as the default.

If a system controller that sets the time in the outdoor unit, such as the G50A, is not connected, the time and days elapsed from the first time the power was turned on will be displayed.

If the time setting has been received, the count will start from the set date and time.

3. The time data is not updated when the outdoor unit's power is off. When the power is turned off and then on again, the count will resume from the time before the power was turned off. Thus, a time differing from the actual time will be saved. (This also applies when a power failure occurs)

The system controller, such as the G50A, sets the time once a day. Thus, if this type of system controller is connected, the time will be updated to the correct time after the settings are received.

(The data stored in the memory before the settings are received will not be corrected.)

#### Reading the time data:

- For time display

Example : 9 hours 12 minutes

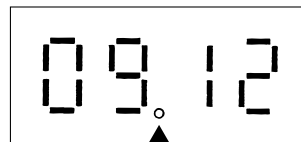

" ." disappears if the time data is deviated due to a power failure, or if a system controller for setting the time is not connected.

- Date display

(1) When upward controller that can set time is connected

Example : May 10, 2003

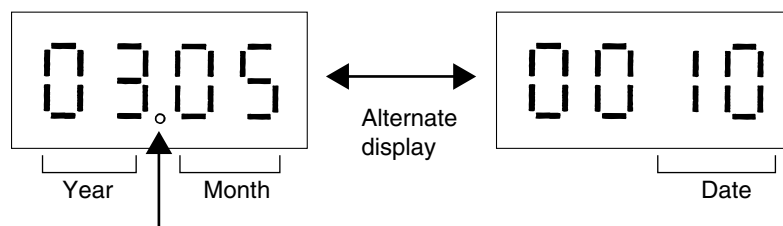

※ The year and month display uses " ." . The date display has no " ." .

(2) When upward controller that can set time is not connected

Example : 52 days after power was turned ON

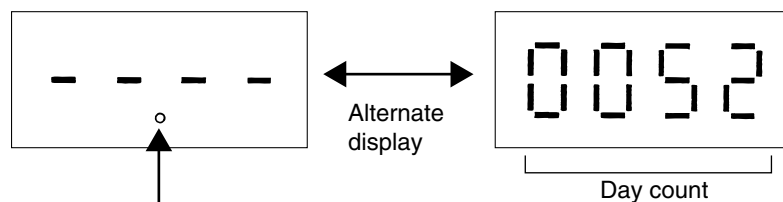

※ The year and month display uses " ." . The date display has no " ." .

#### 4. List of code on the LED monitor

##### LED monitor display

The following abbreviations are used in this table. IC : Indoor unit, OC : Outdoor unit

No.	SW1	Item	LED								Remarks	
	1234567890		LD1	LD2	LD3	LD4	LD5	LD6	LD7	LD8		
0	0000000000	Relay output display 1 (lighting to display)	Comp operation	Comp 1 operation	Comp 2 operation			52C1	52C2		Lights for normal operation	LD8 is a relay output which lights up at all times when the microcomputers power is on.
		Check display 1 OC error	0000 ~ 9999 (Address and error code reversed)									
1	1000000000	Check display 2 OC preliminary error	0000 ~ 9999 (Address and error code reversed)								Display the latest preliminary error. If there is no error, "----" is displayed.	
2	0100000000	Check code 3 (including IC and BC)	0000 ~ 9999 (Address and error code reversed)								If there is no error "----" is displayed.	
3	1100000000	Relay output display 2	21S4a	21S4b	21S4c	CH11	CH12					
4	0010000000	Relay output display 3	SV1		SV3							
5	1010000000	Relay output display 4		SV5b	SV5c					52F		
6	0110000000											
7	1110000000	Special operation	Retry operation	Temporary operation								
8	0001000000											
9	1001000000	Communication demand capacity	0000 ~ 9999								If no demand control, "----" is displayed [ % ].	
10	0101000000	Contact demand capacity	0000 ~ 9999								If no demand control, "----" is displayed [ % ].	
11	1101000000	External signal [signal during input]	Contact demand	Night mode	Snow sensor	Cooling and heating mode selection (Cooling)	Cooling and heating mode selection (Heating)					
12	0011000000											
13	1011000000											
14	0111000000	Outdoor unit operation display		Warm up mode	3 minutes restart protection mode	Compressor operation	Preliminary error	Error	3 minutes restart after instantaneous power failure	Vacuum operation protection delayed		
15	1111000000											
16	0000100000	Indoor unit check	Unit No.1	Unit No.2	Unit No.3	Unit No.4	Unit No.5	Unit No.6	Unit No.7	Unit No.8	If the IC makes an error stop, lit up Unit No.1 can be lit out with error rest in order from small address.	
17	1000100000		Unit No.9	Unit No.10	Unit No.11	Unit No.12	Unit No.13	Unit No.14	Unit No.15	Unit No.16		
18	0100100000		Unit No.17	Unit No.18	Unit No.19	Unit No.20	Unit No.21	Unit No.22	Unit No.23	Unit No.24		
19	1100100000		Unit No.25	Unit No.26	Unit No.27	Unit No.28	Unit No.29	Unit No.30	Unit No.31	Unit No.32		
20	0010100000											
21	1010100000											
22	0110100000											
23	1110100000	Indoor unit operation mode	Unit No.1	Unit No.2	Unit No.3	Unit No.4	Unit No.5	Unit No.6	Unit No.7	Unit No.8	Lights up during cooling. Blinks during heating. Goes off during stop and blower mode.	
24	0001100000		Unit No.9	Unit No.10	Unit No.11	Unit No.12	Unit No.13	Unit No.14	Unit No.15	Unit No.16		
25	1001100000		Unit No.17	Unit No.18	Unit No.19	Unit No.20	Unit No.21	Unit No.22	Unit No.23	Unit No.24		
26	0101100000		Unit No.25	Unit No.26	Unit No.27	Unit No.28	Unit No.29	Unit No.30	Unit No.31	Unit No.32		
27	1101100000											
28	0011100000											
29	1011100000											

No.	SW1	Item	LED								Remarks
	1234567890		LD1	LD2	LD3	LD4	LD5	LD6	LD7	LD8	
30	0111100000	Indoor unit thermostat	Unit No.1	Unit No.2	Unit No.3	Unit No.4	Unit No.5	Unit No.6	Unit No.7	Unit No.8	Lights up when thermostat is on. Goes off when thermostat is off.
31	1111100000		Unit No.9	Unit No.10	Unit No.11	Unit No.12	Unit No.13	Unit No.14	Unit No.15	Unit No.16	
32	0000010000		Unit No.17	Unit No.18	Unit No.19	Unit No.20	Unit No.21	Unit No.22	Unit No.23	Unit No.24	
33	1000010000		Unit No.25	Unit No.26	Unit No.27	Unit No.28	Unit No.29	Unit No.30	Unit No.31	Unit No.32	
34	0100010000										
35	1100010000										
36	0010010000										
37	1010010000										
38	0110010000										
39	1110010000	Outdoor operation mode	Permiss-able stop	Standby	Cooling		Heating				
40	0001010000										
41	1001010000										
42	0101010000	Outdoor unit control mode	Stop	Thermo OFF	Error stop	Regular control	Initial start	Defrost	Oil recovery	Low frequency oil collection	
43	1101010000		Warm up	Refrigerant collection							
44	0011010000										
45	1011010000	TH11					-99.9 ~ 999.9				The unit is [ °C ].
46	0111010000	TH12					↑				
47	1111010000										
48	0000110000	TH5					-99.9 ~ 999.9				
49	1000110000	TH6					↑				
50	0100110000	TH7					↑				
51	1100110000	TH8					↑				
52	0010110000										
53	1010110000										
54	0110110000										
55	1110110000										
56	0001110000										
57	1001110000										
58	0101110000										
59	1101110000										
60	0011110000	THHS1					-99.9 ~ 999.9				The unit is [ °C ].
61	1011110000										
62	0111110000										
63	1111110000	THHS5					-99.9 ~ 999.9				
64	0000001000										
65	1000001000										
66	0100001000										
67	1100001000										
68	0010001000										
69	1010001000										
70	0110001000										



No.	SW1	Item	LED								Remarks
	1234567890		LD1	LD2	LD3	LD4	LD5	LD6	LD7	LD8	
71	1110001000										
72	0001001000	High pressure					-99.9 ~ 999.9				The unit is [ kgf/cm <sup>2</sup> ].
73	1001001000	Low pressure					↑				
74	0101001000										
75	1101001000										
76	0011001000										
77	1011001000										
78	0111001000	Σ Qj					0000 ~ 9999				
79	1111001000	Σ Qjc					↑				
80	0000101000	Σ Qjh					↑				
81	1000101000	Target condensor temp. Tc					-99.9 ~ 999.9				The unit is [ °C ].
82	0100101000	Target condensor temp. Te					↑				
83	1100101000	Tc					↑				
84	0010101000	Te					↑				
85	1010101000										
86	0110101000										
87	1110101000	All temporary frequency					0000 ~ 9999				Control data [ Hz ].
88	0001101000	COMP1 control frequency					↑				
89	1001101000	COMP2 control frequency					↑				
90	0101101000										Frequency that is output from inverter [ Hz ].
91	1101101000	COMP1 output frequency					0000 ~ 9999				
92	0011101000										
93	1011101000										Control data
94	0111101000	AK1					0000 ~ 9999				
95	1111101000										
96	0000011000										Fan inverter output [ % ].
97	1000011000	FAN1					0000 ~ 9999				
98	0100011000										
99	1100011000										
100	0010011000	Number of fans being used					0000 ~ 9999				
101	1010011000										
102	0110011000										
103	1110011000										Outdoor LEV opening pulses (Fully open: 480)
104	0001011000	LEV1					0 ~ 480				
105	1001011000										
106	0101011000										
107	1101011000										Peak value [ A ].
108	0011011000	COMP1 operation current (DC)					-99.9 ~ 999.9				
109	1011011000										
110	0111011000										

No.	SW1	Item	LED								Remarks
	1234567890		LD1	LD2	LD3	LD4	LD5	LD6	LD7	LD8	
111	1111011000	COMP1 bus voltage	0000 ~ 9999								The unit is [ V ].
112	0000111000										
113	1000111000										
114	0100111000										
115	1100111000										
116	0010111000										
117	1010111000	Compressor 1 operation time upper 4 digits.	0000 ~ 9999								The unit is [ h ].
118	0110111000	Compressor 1 operation time lower 4 digits.	↑								
119	1110111000	Compressor 2 operation time upper 4 digits.	↑								
120	0001111000	Compressor 2 operation time lower 4 digits.	↑								
121	1001111000										
122	0101111000										
123	1101111000	COMP 1 number of starts and stops upper 4 digits.	0000 ~ 9999								Count up when starting up. [ Time ]
124	0011111000	COMP 1 number of starts and stops lower 4 digits.	↑								
125	1011111000	COMP 2 number of starts and stops upper 4 digits.	↑								
126	0111111000	COMP 2 number of starts and stops lower 4 digits.	↑								
127	1111111000										
128	000000100										
129	100000100										
130	010000100										
131	110000100										
132	001000100										
133	101000100										
134	011000100										
135	111000100										
136	0001000100										
137	1001000100										
138	0101000100										
139	1101000100										
140	0011000100										
141	1011000100										
142	0111000100										
143	1111000100										
144	0000100100										
145	1000100100										
146	0100100100										
147	1100100100										
148	0010100100										
149	1010100100										

No.	SW1	Item	LED								Remarks
	1234567890		LD1	LD2	LD3	LD4	LD5	LD6	LD7	LD8	
150	0110100100										
151	1110100100										
152	0001100100										
153	1001100100										
154	0101100100										
155	1101100100										
156	0011100100										
157	1011100100										
158	0111100100										
159	1111100100										
160	0000010100										
161	1000010100										
162	0100010100										
163	1100010100										
164	0010010100										
165	1010010100										
166	0110010100										
167	1110010100										
168	0001010100										
169	1001010100										
170	0101010100										
171	1101010100										
172	0011010100										
173	1011010100										
174	0111010100										
175	1111010100										
176	0000110100										
177	1000110100										
178	0100110100	Error history 1					0000 ~ 9999				
179	1100110100	Inverter error detail					Inverter error detail (0001 ~ 0120)				
180	0010110100	Error history 2					0000 ~ 9999				
181	1010110100	Inverter error detail					Inverter error detail (0001 ~ 0120)				
182	0110110100	Error history 3					0000 ~ 9999				
183	1110110100	Inverter error detail					Inverter error detail (0001 ~ 0120)				
184	0001110100	Error history 4					0000 ~ 9999				
185	1001110100	Inverter error detail					Inverter error detail (0001 ~ 0120)				
186	0101110100	Error history 5					0000 ~ 9999				
187	1101110100	Inverter error detail					Inverter error detail (0001 ~ 0120)				
188	0011110100	Error history 6					0000 ~ 9999				
189	1011110100	Inverter error detail					Inverter error detail (0001 ~ 0120)				
190	0111110100	Error history 7					0000 ~ 9999				
191	1111110100	Inverter error detail					Inverter error detail (0001 ~ 0120)				
192	0000001100	Error history 8					0000 ~ 9999				

Address and error code are reversed and displayed.  
"----" is displayed when there is no error.

No.	SW1	Item	LED								Remarks
	1234567890		LD1	LD2	LD3	LD4	LD5	LD6	LD7	LD8	
193	1000001100	Inverter error detail	Inverter error detail (0001 ~ 0120)								Address and error code are reversed and displayed. "----" is displayed when there is no error.
194	0100001100	Error history 9	0000 ~ 9999								
195	1100001100	Inverter error detail	Inverter error detail (0001 ~ 0120)								
196	0010001100	Error history 10	0000 ~ 9999								
197	1010001100	Inverter error detail	Inverter error detail (0001 ~ 0120)								
198	0110001100	Inverter error history (when saving data before an error)	0000 ~ 9999								
199	1110001100	Inverter error detail	Inverter error detail (0001 ~ 0120)								
200	0001001100										
201	1001001100	Outdoor unit operation display		Warm up mode	3 minutes restart protection mode	Compressor operation	Preliminary error	Error	3 minutes restart after instantaneous power failure	Vacuum operation protection delayed	
202	0101001100										
203	1101001100										
204	0011001100										
205	1011001100	Outdoor operation mode	Permissible stop	Standby	Cooling		Heating				
206	0111001100										
207	1111001100										
208	0000101100	Outdoor unit control mode	Stop	Thermo OFF	Error stop	Regular control	Initial start	Defrost	Oil recovery	Low frequency oil collection	
209	1000101100		Warm up	Refrigerant collection							
210	0100101100										
211	1100101100	Relay output display 1 (lighting to display)	Comp operation	Comp 1 operation	Comp 2 operation		52C1	52C2		Lights for normal operation	
212	0010101100	Relay output display 2 (lighting to display)	21S4a	21S4b	21S4c	CH11	CH12				
213	1010101100	Relay output display 3 (lighting to display)	SV1		SV3						
214	0110101100	Relay output display 4 (lighting to display)		SV5b	SV5c				52F		
215	1110101100										
216	0001101100	TH11	-99.9 ~ 999.9								The unit is [ °C ].
217	1001101100	TH12	↑								
218	0101101100										
219	1101101100	TH5	-99.9 ~ 999.9								
220	0011101100	TH6	↑								
221	1011101100	TH7	↑								
222	0111101100	TH8	↑								
223	1111101100										
224	0000011100										
225	1000011100										
226	0100011100										
227	1100011100										
228	0010011100										

No.	SW1	Item	LED								Remarks
	1234567890		LD1	LD2	LD3	LD4	LD5	LD6	LD7	LD8	
229	1010011100										The unit is [ °C ].
230	0110011100										
231	1110011100	THHS1					-99.9 ~ 999.9				
232	0001011100										
233	1001011100										
234	0101011100	THHS5					-99.9 ~ 999.9				
235	1101011100										
236	0011011100										
237	1011011100										
238	0111011100										
239	1111011100										
240	0000111100										
241	1000111100										
242	0100111100										
243	1100111100	High pressure					-99.9 ~ 999.9				The unit is [ kgf/cm <sup>2</sup> ].
244	0010111100	Low pressure					↑				
245	1010111100										
246	0110111100										
247	1110111100										
248	0001111100										
249	1001111100	Σ Qj					0000 ~ 9999				
250	0101111100	Σ Qjc					↑				
251	1101111100	Σ Qjh					↑				
252	0011111100	Target condensor temp. Tc					-99.9 ~ 999.9				The unit is [ °C ].
253	1011111100	Target condensor temp. Te					↑				
254	0111111100	Tc					↑				
255	1111111100	Te					↑				
256	0000000010										Control data [ Hz ].
257	1000000010										
258	0100000010	All temporary frequency					0000 ~ 9999				
259	1100000010	COMP1 control frequency					↑				
260	0010000010	COMP2 control frequency					↑				Frequency that is output from inverter [ Hz ].
261	1010000010										
262	0110000010	COMP1 output frequency					0000 ~ 9999				
263	1110000010										Control data
264	0001000010										
265	1001000010	AK1					0000 ~ 9999				Fan inverter output [ % ].
266	0101000010										
267	1101000010										
268	0011000010	FAN1					0000 ~ 9999				Fan inverter output [ % ].
269	1011000010										
270	0111000010										

No.	SW1	Item	LED								Remarks	
	1234567890		LD1	LD2	LD3	LD4	LD5	LD6	LD7	LD8		
271	1111000010	Number of fans being used	0000 ~ 9999									
272	0000100010											
273	1000100010											
274	0100100010											
275	1100100010	LEV1	0 ~ 480									Outdoor LEV opening pulses (Fully open: 480)
276	0010100010											
277	1010100010											
278	0110100010											
279	1110100010	COMP1 operation current (DC)	-99.9 ~ 999.9									Peak value [ A ].
280	0001100010											
281	1001100010											
282	0101100010	COMP1 bus voltage	-99.9 ~ 999.9									The unit is [ V ].
283	1101100010											
284	0011100010											
285	1011100010											
286	0111100010											
287	1111100010											
288	0000010010	Compressor 1 operation time upper 4 digits.	0000 ~ 9999									The unit is [ h ].
289	1000010010	Compressor 1 operation time lower 4 digits.	↑									
290	0100010010	Compressor 2 operation time upper 4 digits.	↑									
291	1100010010	Compressor 2 operation time lower 4 digits.	↑									
292	0010010010											
293	1010010010											
294	0110010010	COMP 1 number of starts and stops upper 4 digits.	0000 ~ 9999									Count up when starting up. [ Time ]
295	1110010010	COMP 1 number of starts and stops lower 4 digits.	↑									
296	0001010010	COMP 2 number of starts and stops upper 4 digits.	↑									
297	1001010010	COMP 2 number of starts and stops lower 4 digits.	↑									
298	0101010010											
299	1101010010											
300	0011010010											
301	1011010010											
302	0111010010											
303	1111010010											
304	0000110010											
305	1000110010											
306	0100110010											
307	1100110010											
308	0010110010											

No.	SW1	Item	LED								Remarks
	1234567890		LD1	LD2	LD3	LD4	LD5	LD6	LD7	LD8	
309	1010110010										
310	0110110010										
311	1110110010										
312	0001110010										
313	1001110010										
314	0101110010										
315	1101110010										
316	0011110010										
317	1011110010										
318	0111110010										
319	1111110010										
320	0000001010										
321	1000001010										
322	0100001010										
323	1100001010										
324	0010001010										
325	1010001010										
326	0110001010										
327	1110001010										
328	0001001010										
329	1001001010										
330	0101001010										
331	1101001010										
332	0011001010										
333	1011001010										
334	0111001010										
355	1111001010										
336	0000101010										
337	1000101010										
338	0100101010										
339	1100101010										
340	0010101010										
341	1010101010										
342	0110101010										
343	1110101010										
344	0001101010										
345	1001101010										
346	0101101010										
347	1101101010										
348	0011101010										
349	1011101010										
350	0111101010										
351	1111101010	IC1 Address/Capacity code	0000 ~ 9999				0000 ~ 9999				Displayed alternately every 5 seconds.
352	0000011010	IC2 Address/Capacity code	↑				↑				

No.	SW1	Item	LED								Remarks
	1234567890		LD1	LD2	LD3	LD4	LD5	LD6	LD7	LD8	
353	1000011010	IC3 Address/Capacity code	0000 ~ 9999				0000 ~ 9999				Displayed alternately every 5 seconds.
354	0100011010	IC4 Address/Capacity code	↑				↑				
355	1100011010	IC5 Address/Capacity code	↑				↑				
356	0010011010	IC6 Address/Capacity code	↑				↑				
357	1010011010	IC7 Address/Capacity code	↑				↑				
358	0110011010	IC8 Address/Capacity code	↑				↑				
359	1110011010	IC9 Address/Capacity code	↑				↑				
360	0001011010	IC10 Address/Capacity code	↑				↑				
361	1001011010	IC11 Address/Capacity code	↑				↑				
362	0101011010	IC12 Address/Capacity code	↑				↑				
363	1101011010	IC13 Address/Capacity code	↑				↑				
364	0011011010	IC14 Address/Capacity code	↑				↑				
365	1011011010	IC15 Address/Capacity code	↑				↑				
366	0111011010	IC16 Address/Capacity code	↑				↑				
367	1111011010	IC17 Address/Capacity code	↑				↑				
368	0000111010	IC18 Address/Capacity code	↑				↑				
369	1000111010	IC19 Address/Capacity code	↑				↑				
370	0100111010	IC20 Address/Capacity code	↑				↑				
371	1100111010	IC21 Address/Capacity code	↑				↑				
372	0010111010	IC22 Address/Capacity code	↑				↑				
373	1010111010	IC23 Address/Capacity code	↑				↑				
374	0110111010	IC24 Address/Capacity code	↑				↑				
375	1110111010	IC25 Address/Capacity code	↑				↑				
376	0001111010	IC26 Address/Capacity code	↑				↑				
377	1001111010	IC27 Address/Capacity code	↑				↑				
378	0101111010	IC28 Address/Capacity code	↑				↑				
379	1101111010	IC29 Address/Capacity code	↑				↑				
380	0011111010	IC30 Address/Capacity code	↑				↑				
381	1011111010	IC31 Address/Capacity code	↑				↑				
382	0111111010	IC32 Address/Capacity code	↑				↑				
383	1111111010										
384	000000110										
385	100000110										
386	010000110										
387	110000110										
388	001000110										
389	101000110										
390	011000110										
391	111000110										
392	0001000110										
393	1001000110										
394	0101000110										
395	1101000110										



No.	SW1	Item	LED								Remarks
	1234567890		LD1	LD2	LD3	LD4	LD5	LD6	LD7	LD8	
396	0011000110										
397	1011000110										
398	0111000110										
399	1111000110										
400	0000100110										
401	1000100110										
402	0100100110										
403	1100100110										
404	0010100110										
405	1010100110										
406	0110100110										
407	1110100110										
408	0001100110	IC1 Suction temperature					-99.9 ~ 999.9				The unit is [ °C ].
409	1001100110	IC2 Suction temperature					↑				
410	0101100110	IC3 Suction temperature					↑				
411	1101100110	IC4 Suction temperature					↑				
412	0011100110	IC5 Suction temperature					↑				
413	1011100110	IC6 Suction temperature					↑				
414	0111100110	IC7 Suction temperature					↑				
415	1111100110	IC8 Suction temperature					↑				
416	0000010110	IC9 Suction temperature					↑				
417	1000010110	IC10 Suction temperature					↑				
418	0100010110	IC11 Suction temperature					↑				
419	1100010110	IC12 Suction temperature					↑				
420	0010010110	IC13 Suction temperature					↑				
421	1010010110	IC14 Suction temperature					↑				
422	0110010110	IC15 Suction temperature					↑				
423	1110010110	IC16 Suction temperature					↑				
424	0001010110	IC17 Suction temperature					↑				
425	1001010110	IC18 Suction temperature					↑				
426	0101010110	IC19 Suction temperature					↑				
427	1101010110	IC20 Suction temperature					↑				
428	0011010110	IC21 Suction temperature					↑				
429	1011010110	IC22 Suction temperature					↑				
430	0111010110	IC23 Suction temperature					↑				
431	1111010110	IC24 Suction temperature					↑				
432	0000110110	IC25 Suction temperature					↑				
433	1000110110	IC26 Suction temperature					↑				
434	0100110110	IC27 Suction temperature					↑				
435	1100110110	IC28 Suction temperature					↑				
436	0010110110	IC29 Suction temperature					↑				
437	1010110110	IC30 Suction temperature					↑				
438	0110110110	IC31 Suction temperature					↑				

No.	SW1	Item	LED								Remarks
	1234567890		LD1	LD2	LD3	LD4	LD5	LD6	LD7	LD8	
439	1110110110	IC32 Suction temperature	-99.9 ~ 999.9								The unit is [ °C ].
440	0001110110										
441	1001110110										
442	0101110110										
443	1101110110										
444	0011110110										
445	1011110110										
446	0111110110										
447	1111110110										
448	0000001110										
449	1000001110										
450	0100001110										
451	1100001110										
452	0010001110										
453	1010001110										
454	0110001110										
455	1110001110										
456	0001001110										
457	1001001110										
458	0101001110	IC1 Liquid pipe temp.	-99.9 ~ 999.9								
459	1101001110	IC2 Liquid pipe temp.	↑								
460	0011001110	IC3 Liquid pipe temp.	↑								
461	1011001110	IC4 Liquid pipe temp.	↑								
462	0111001110	IC5 Liquid pipe temp.	↑								
463	1111001110	IC6 Liquid pipe temp.	↑								
464	0000101110	IC7 Liquid pipe temp.	↑								
465	1000101110	IC8 Liquid pipe temp.	↑								
466	0100101110	IC9 Liquid pipe temp.	↑								
467	1100101110	IC10 Liquid pipe temp.	↑								
468	0010101110	IC11 Liquid pipe temp.	↑								
469	1010101110	IC12 Liquid pipe temp.	↑								
470	0110101110	IC13 Liquid pipe temp.	↑								
471	1110101110	IC14 Liquid pipe temp.	↑								
472	0001101110	IC15 Liquid pipe temp.	↑								
473	1001101110	IC16 Liquid pipe temp.	↑								
474	0101101110	IC17 Liquid pipe temp.	↑								
475	1101101110	IC18 Liquid pipe temp.	↑								
476	0011101110	IC19 Liquid pipe temp.	↑								
477	1011101110	IC20 Liquid pipe temp.	↑								
478	0111101110	IC21 Liquid pipe temp.	↑								
479	1111101110	IC22 Liquid pipe temp.	↑								
480	0000011110	IC23 Liquid pipe temp.	↑								
481	1000011110	IC24 Liquid pipe temp.	↑								

No.	SW1	Item	LED								Remarks
	1234567890		LD1	LD2	LD3	LD4	LD5	LD6	LD7	LD8	
482	0100011110	IC25 Liquid pipe temp.	-99.9 ~ 999.9								The unit is [ °C ].
483	1100011110	IC26 Liquid pipe temp.	↑								
484	0010011110	IC27 Liquid pipe temp.	↑								
485	1010011110	IC28 Liquid pipe temp.	↑								
486	0110011110	IC29 Liquid pipe temp.	↑								
487	1110011110	IC30 Liquid pipe temp.	↑								
488	0001011110	IC31 Liquid pipe temp.	↑								
489	1001011110	IC32 Liquid pipe temp.	↑								
490	0101011110										
491	1101011110										
492	0011011110										
493	1011011110										
494	0111011110										
495	1111011110										
496	0000111110										
497	1000111110										
498	0100111110										
499	1100111110										
500	0010111110										
501	1010111110										
502	0110111110										
503	1110111110										
504	0001111110										
505	1001111110										
506	0101111110										
507	1101111110										
508	0011111110										
509	1011111110										
510	0111111110										
511	1111111110										
512	0000000001	Self-address	Self-address and model code are alternately displayed								
513	1000000001	IC/FU address	Display count up for the number of connected units								
514	0100000001	RC address	Display count up for the number of connected units								
515	1100000001	BC/TU address	Display count up for the number of connected units								
516	0010000001	OS address	Display count up for the number of connected units								
517	1010000001	Main board S/W version	S/W version → Refrigerant type → Cooling only / Cooling & Heating capacity → Address								Refer to LED display at initial setting
518	0110000001										
519	1110000001										
520	0001000001										
521	1001000001										
522	0101000001										
523	1101000001	IC1 Gas pipe temp.	-99.9 ~ 999.9								The unit is [ °C ].
524	0011000001	IC2 Gas pipe temp.	↑								

No.	SW1	Item	LED								Remarks
	1234567890		LD1	LD2	LD3	LD4	LD5	LD6	LD7	LD8	
525	1011000001	IC3 Gas pipe temp.	-99.9 ~ 999.9								The unit is [ °C ].
526	0111000001	IC4 Gas pipe temp.	↑								
527	1111000001	IC5 Gas pipe temp.	↑								
528	0000100001	IC6 Gas pipe temp.	↑								
529	1000100001	IC7 Gas pipe temp.	↑								
530	0100100001	IC8 Gas pipe temp.	↑								
531	1100100001	IC9 Gas pipe temp.	↑								
532	0010100001	IC10 Gas pipe temp.	↑								
533	1010100001	IC11 Gas pipe temp.	↑								
534	0110100001	IC12 Gas pipe temp.	↑								
535	1110100001	IC13 Gas pipe temp.	↑								
536	0001100001	IC14 Gas pipe temp.	↑								
537	1001100001	IC15 Gas pipe temp.	↑								
538	0101100001	IC16 Gas pipe temp.	↑								
539	1101100001	IC17 Gas pipe temp.	↑								
540	0011100001	IC18 Gas pipe temp.	↑								
541	1011100001	IC19 Gas pipe temp.	↑								
542	0111100001	IC20 Gas pipe temp.	↑								
543	1111100001	IC21 Gas pipe temp.	↑								
544	0000100001	IC22 Gas pipe temp.	↑								
545	1000010001	IC23 Gas pipe temp.	↑								
546	0100010001	IC24 Gas pipe temp.	↑								
547	1100010001	IC25 Gas pipe temp.	↑								
548	0010010001	IC26 Gas pipe temp.	↑								
549	1010010001	IC27 Gas pipe temp.	↑								
550	0110010001	IC28 Gas pipe temp.	↑								
551	1110010001	IC29 Gas pipe temp.	↑								
552	0001010001	IC30 Gas pipe temp.	↑								
553	1001010001	IC31 Gas pipe temp.	↑								
554	0101010001	IC32 Gas pipe temp.	↑								
555	1101010001										
556	0011010001										
557	1011010001										
558	0111010001										
559	1111010001										
560	0000110001										
561	1000110001										
562	0100110001										
563	1100110001										
564	0010110001										
565	1010110001										
566	0110110001										
567	1110110001										

No.	SW1	Item	LED								Remarks
	1234567890		LD1	LD2	LD3	LD4	LD5	LD6	LD7	LD8	
568	0001110001										
569	1001110001										
570	0101110001										
571	1101110001										
572	0011110001										
573	1011110001	IC1SH					-99.9 ~ 999.9				The unit is [ deg ].
574	0111110001	IC2SH					↑				
575	1111110001	IC3SH					↑				
576	0000001001	IC4SH					↑				
577	1000001001	IC5SH					↑				
578	0100001001	IC6SH					↑				
579	1100001001	IC7SH					↑				
580	0010001001	IC8SH					↑				
581	1010001001	IC9SH					↑				
582	0110001001	IC10SH					↑				
583	1110001001	IC11SH					↑				
584	0001001001	IC12SH					↑				
585	1001001001	IC13SH					↑				
586	0101001001	IC14SH					↑				
587	1101001001	IC15SH					↑				
588	0011001001	IC16SH					↑				
589	1011001001	IC17SH					↑				
590	0111001001	IC18SH					↑				
591	1111001001	IC19SH					↑				
592	0000101001	IC20SH					↑				
593	1000101001	IC21SH					↑				
594	0100101001	IC22SH					↑				
595	1100101001	IC23SH					↑				
596	0010101001	IC24SH					↑				
597	1010101001	IC25SH					↑				
598	0110101001	IC26SH					↑				
599	1110101001	IC27SH					↑				
600	0001101001	IC28SH					↑				
601	1001101001	IC29SH					↑				
602	0101101001	IC30SH					↑				
603	1101101001	IC31SH					↑				
604	0011101001	IC32SH					↑				
605	1011101001										
606	0111101001										
607	1111101001										
608	0000011001										
609	1000011001										
610	0100011001										

No.	SW1	Item	LED								Remarks
	1234567890		LD1	LD2	LD3	LD4	LD5	LD6	LD7	LD8	
611	1100011001										
612	0010011001										
613	1010011001										
614	0110011001										
615	1110011001										
616	0001011001										
617	1001011001										
618	0101011001										
619	1101011001										
620	0011011001										
621	1011011001										
622	0111011001										
623	1111011001	IC1SC					-99.9 ~ 999.9				The unit is [ deg ].
624	0000111001	IC2SC					↑				
625	1000111001	IC3SC					↑				
626	0100111001	IC4SC					↑				
627	1100111001	IC5SC					↑				
628	0010111001	IC6SC					↑				
629	1010111001	IC7SC					↑				
630	0110111001	IC8SC					↑				
631	1110111001	IC9SC					↑				
632	0001111001	IC10SC					↑				
633	1001111001	IC11SC					↑				
634	0101111001	IC12SC					↑				
635	1101111001	IC13SC					↑				
636	0011111001	IC14SC					↑				
637	1011111001	IC15SC					↑				
638	0111111001	IC16SC					↑				
639	1111111001	IC17SC					↑				
640	0000000101	IC18SC					↑				
641	1000000101	IC19SC					↑				
642	0100000101	IC20SC					↑				
643	1100000101	IC21SC					↑				
644	0010000101	IC22SC					↑				
645	1010000101	IC23SC					↑				
646	0110000101	IC24SC					↑				
647	1110000101	IC25SC					↑				
648	0001000101	IC26SC					↑				
649	1001000101	IC27SC					↑				
650	0101000101	IC28SC					↑				
651	1101000101	IC29SC					↑				
652	0011000101	IC30SC					↑				
653	1011000101	IC31SC					↑				

No.	SW1	Item	LED								Remarks
	1234567890		LD1	LD2	LD3	LD4	LD5	LD6	LD7	LD8	
654	0111000101	IC32SC	-99.9 ~ 999.9								The unit is [ deg ].
655	1111000101										
656	0000100101										
657	1000100101										
658	0100100101										
659	1100100101										
660	0010100101										
661	1010100101										
662	0110100101										
663	1110100101										
664	0001100101										
665	1001100101										
666	0101100101										
667	1101100101										
668	0011100101										
669	1011100101										
670	0111100101										
671	1111100101										
672	0000010101										
673	1000010101										
674	0100010101										
675	1100010101										
676	0010010101	INV board S/W version	0.00 ~ 99.99								
677	1010010101										
678	0110010101										
679	1110010101	FAN board S/W version	0.00 ~ 99.99								
680	0001010101										
681	1001010101										
682	0101010101										
683	1101010101										
684	0011010101										
685	1011010101										
686	0111010101										
687	1111010101										
688	0000110101	Current time	00:00 ~ 23:59								
689	1000110101	Current time-2	00.00 ~ 99.12 / 1 ~ 31								Display alternately year/month and day
690	0100110101	Error detection time1	00:00 ~ 23:59								Hour : minute
691	1100110101	Error detection time1-2	00.00 ~ 99.12 / 1 ~ 31								Display alternately year/month and day
692	0010110101	Error detection time2	00:00 ~ 23:59								Hour : minute
693	1010110101	Error detection time2-2	00.00 ~ 99.12 / 1 ~ 31								Display alternately year/month and day
694	0110110101	Error detection time3	00:00 ~ 23:59								Hour : minute
695	1110110101	Error detection time3-2	00.00 ~ 99.12 / 1 ~ 31								Display alternately year/month and day

No.	SW1	Item	LED								Remarks
	1234567890		LD1	LD2	LD3	LD4	LD5	LD6	LD7	LD8	
696	0001110101	Error detection time4	00:00 ~ 23:59								Hour : minute
697	1001110101	Error detection time4-2	00.00 ~ 99.12 / 1 ~ 31								Display alternately year/month and day
698	0101110101	Error detection time5	00:00 ~ 23:59								Hour : minute
699	1101110101	Error detection time5-2	00.00 ~ 99.12 / 1 ~ 31								Display alternately year/month and day
700	0011110101	Error detection time6	00:00 ~ 23:59								Hour : minute
701	1011110101	Error detection time6-2	00.00 ~ 99.12 / 1 ~ 31								Display alternately year/month and day
702	0111110101	Error detection time7	00:00 ~ 23:59								Hour : minute
703	1111110101	Error detection time7-2	00.00 ~ 99.12 / 1 ~ 31								Display alternately year/month and day
704	0000001101	Error detection time8	00:00 ~ 23:59								Hour : minute
705	1000001101	Error detection time8-2	00.00 ~ 99.12 / 1 ~ 31								Display alternately year/month and day
706	0100001101	Error detection time9	00:00 ~ 23:59								Hour : minute
707	1100001101	Error detection time9-2	00.00 ~ 99.12 / 1 ~ 31								Display alternately year/month and day
708	0010001101	Error detection time10	00:00 ~ 23:59								Hour : minute
709	1010001101	Error detection time10-2	00.00 ~ 99.12 / 1 ~ 31								Display alternately year/month and day
710	0110001101	Time when data before error is saved	00:00 ~ 23:59								Hour : minute
711	1110001101	Time when data before error is saved-2	00.00 ~ 99.12 / 1 ~ 31								Display alternately year/month and day
712	0001001101										
713	1001001101										
714	0101001101	IC1 LEV opening pulses	0000 ~ 2000								Fully open : 2000
715	1101001101	IC2 LEV opening pulses	↑								
716	0011001101	IC3 LEV opening pulses	↑								
717	1011001101	IC4 LEV opening pulses	↑								
718	0111001101	IC5 LEV opening pulses	↑								
719	1111001101	IC6 LEV opening pulses	↑								
720	0000101101	IC7 LEV opening pulses	↑								
721	1000101101	IC8 LEV opening pulses	↑								
722	0100101101	IC9 LEV opening pulses	↑								
723	1100101101	IC10 LEV opening pulses	↑								
724	0010101101	IC11 LEV opening pulses	↑								
725	1010101101	IC12 LEV opening pulses	↑								
726	0110101101	IC13 LEV opening pulses	↑								
727	1110101101	IC14 LEV opening pulses	↑								
728	0001101101	IC15 LEV opening pulses	↑								
729	1001101101	IC16 LEV opening pulses	↑								
730	0101101101	IC17 LEV opening pulses	↑								
731	1101101101	IC18 LEV opening pulses	↑								
732	0011101101	IC19 LEV opening pulses	↑								
733	1011101101	IC20 LEV opening pulses	↑								
734	0111101101	IC21 LEV opening pulses	↑								
735	1111101101	IC22 LEV opening pulses	↑								
736	0000011101	IC23 LEV opening pulses	↑								
737	1000011101	IC24 LEV opening pulses	↑								



No.	SW1	Item	LED								Remarks
	1234567890		LD1	LD2	LD3	LD4	LD5	LD6	LD7	LD8	
738	0100011101	IC25 LEV opening pulses	0000 ~ 2000								Fully open : 2000
739	1100011101	IC26 LEV opening pulses	↑								
740	0010011101	IC27 LEV opening pulses	↑								
741	1010011101	IC28 LEV opening pulses	↑								
742	0110011101	IC29 LEV opening pulses	↑								
743	1110011101	IC30 LEV opening pulses	↑								
744	0001011101	IC31 LEV opening pulses	↑								
745	1001011101	IC32 LEV opening pulses	↑								
746	0101011101										
747	1101011101										
748	0011011101										
749	1011011101										
750	0111011101										
751	1111011101										
752	0000111101										
753	1000111101										
754	0100111101										
755	1100111101										
756	0010111101										
757	1010111101										
758	0110111101										
759	1110111101										
760	0001111101										
761	1001111101										
762	0101111101										
763	1101111101										
764	0011111101	IC1 Operation mode	0000 : Off 0001 : Fan 0002 : Cooling 0003 : Heating 0004 : Dry								
765	1011111101	IC2 Operation mode									
766	0111111101	IC3 Operation mode									
767	1111111101	IC4 Operation mode									
768	000000011	IC5 Operation mode									
769	100000011	IC6 Operation mode									
770	010000011	IC7 Operation mode									
771	110000011	IC8 Operation mode									
772	001000011	IC9 Operation mode									
773	101000011	IC10 Operation mode									
774	011000011	IC11 Operation mode									
775	111000011	IC12 Operation mode									
776	000100011	IC13 Operation mode									
777	100100011	IC14 Operation mode									
778	010100011	IC15 Operation mode									
779	110100011	IC16 Operation mode									
780	001100011	IC17 Operation mode									

No.	SW1	Item	LED								Remarks		
	1234567890		LD1	LD2	LD3	LD4	LD5	LD6	LD7	LD8			
781	1011000011	IC18 Operation mode											
782	0111000011	IC19 Operation mode											
783	1111000011	IC20 Operation mode											
784	0000100011	IC21 Operation mode											
785	1000100011	IC22 Operation mode											
786	0100100011	IC23 Operation mode									0000 : Off		
787	1100100011	IC24 Operation mode									0001 : Fan		
788	0010100011	IC25 Operation mode									0002 : Cooling		
789	1010100011	IC26 Operation mode									0003 : Heating		
790	0110100011	IC27 Operation mode									0004 : Dry		
791	1110100011	IC28 Operation mode											
792	0001100011	IC29 Operation mode											
793	1001100011	IC30 Operation mode											
794	0101100011	IC31 Operation mode											
795	1101100011	IC32 Operation mode											
796	0011100011												
797	1011100011												
798	0111100011												
799	1111100011												
800	0000010011												
801	1000010011												
802	0100010011												
803	1100010011												
804	0010010011												
805	1010010011												
806	0110010011												
807	1110010011												
808	0001010011												
809	1001010011												
810	0101010011												
811	1101010011												
812	0011010011												
813	1011010011												
814	0111010011	IC1 Filter									0000 ~ 9999	Hours since previous maintenance [ h ]	
815	1111001001	IC2 Filter									↑		
816	0000101011	IC3 Filter									↑		
817	1000101011	IC4 Filter									↑		
818	0100101011	IC5 Filter									↑		
819	1100101011	IC6 Filter									↑		
820	0010101011	IC7 Filter									↑		
821	1010101011	IC8 Filter									↑		
822	0110101011	IC9 Filter									↑		
823	1110101011	IC10 Filter									↑		

No.	SW1	Item	LED								Remarks
	1234567890		LD1	LD2	LD3	LD4	LD5	LD6	LD7	LD8	
824	0001101011	IC11 Filter	0000 ~ 9999								Hours since previous maintenance [ h ]
825	1001101011	IC12 Filter	↑								
826	0101101011	IC13 Filter	↑								
827	1101101011	IC14 Filter	↑								
828	0011101011	IC15 Filter	↑								
829	1011101011	IC16 Filter	↑								
830	0111101011	IC17 Filter	↑								
831	1111101011	IC18 Filter	↑								
832	0000011011	IC19 Filter	↑								
833	1000011011	IC20 Filter	↑								
834	0100011011	IC21 Filter	↑								
835	1100011011	IC22 Filter	↑								
836	0010011011	IC23 Filter	↑								
837	1010011011	IC24 Filter	↑								
838	0110011011	IC25 Filter	↑								
839	1110011011	IC26 Filter	↑								
840	0001011011	IC27 Filter	↑								
841	1001011011	IC28 Filter	↑								
842	0101011011	IC29 Filter	↑								
843	1101011011	IC30 Filter	↑								
844	0011011011	IC31 Filter	↑								
845	1011011011	IC32 Filter	↑								
846	0111001001										
847	1111001011										
848	0000101011										
849	1000101011										
850	0100101011										
851	1100101011										
852	0010101011										
853	1010101011										
854	0110101011										
855	1110101011										
856	0001101011										
857	1001101011										
858	0101101011										
859	1101101011										
860	0011101011										
861	1011101011										
862	0111101011										
863	1111101011										
864	0000011011										
865	1000011011										
866	0100011011										

No.	SW1	Item	LED								Remarks
	1234567890		LD1	LD2	LD3	LD4	LD5	LD6	LD7	LD8	
867	1100011011										
868	0010011011										
869	1010011011										
870	0110011011										
871	1110011011	U phase current effective value 1					-99.9 ~ 999.9				The unit is [ A ].
872	0001011011	W phase current effective value 1					↑				
873	1001011011	Power factor phase angle 1 (deg)					↑				The unit is [ deg ].
874	0101011011										
875	1101011011										
876	0011011011										
877	1011011011										
878	0111011011										
879	1111011011										
880	0000111011	Main circuit board reset counter					0 ~ 254				The unit is [ Time ].
881	1000111011	INV board reset counter					↑				
882	0100111011										
883	1100111011										
884	0010111011	FAN board reset counter					0 ~ 254				
885	1010111011										
886	0110111011										
887	1110111011										
888	0001111011										
889	1001111011										
890	0101111011										
891	1101111011										
892	0011111011										
893	1011111011										
894	0111111011										
895	1111111011										
896	0000000111										
897	1000000111										
898	0100000111										
899	1100000111										
900	0010000111										
901	1010000111										
902	0110000111										
903	1110000111										
904	0001000111										
905	1001000111										
906	0101000111										

No.	SW1	Item	LED								Remarks
	1234567890		LD1	LD2	LD3	LD4	LD5	LD6	LD7	LD8	
907	1101000111										
1020	0011111111										
1021	1011111111										
1022	0111111111										
1023	1111111111										

**Service Handbook PUHY-P200, P250, P300, P350, P400YGM-A  
PUHY-P450, P500, P550, P600, P650YGM-A  
PUY-P200, P250, P300, P350YGM-A**

