

Air-Conditioners For Building Application

OUTDOOR UNIT

CE

PUMY-P125VMA

GB

D

F

E

I

NL

P

GR

INSTALLATION MANUAL

For safe and correct use, please read this installation manual thoroughly before installing the air-conditioner unit.

INSTALLATIONSHANDBUCH

Zum sicheren und ordnungsgemäßen Gebrauch der Klimageräte das Installationshandbuch gründlich durchlesen.

MANUEL D'INSTALLATION

Veillez lire le manuel d'installation en entier avant d'installer ce climatiseur pour éviter tout accident et vous assurer d'une utilisation correcte.

MANUAL DE INSTALACIÓN

Para un uso seguro y correcto, lea detalladamente este manual de instalación antes de montar la unidad de aire acondicionado.

MANUALE DI INSTALLAZIONE

Per un uso sicuro e corretto, leggere attentamente questo manuale di installazione prima di installare il condizionatore d'aria.

INSTALLATIEHANDLEIDING

Voor een veilig en juist gebruik moet u deze installatiehandleiding grondig doorlezen voordat u de airconditioner installeert.

MANUAL DE INSTALAÇÃO

Para segurança e utilização correctas, leia atentamente este manual de instalação antes de instalar a unidade de ar condicionado.

ΕΓΧΕΙΡΙΔΙΟ ΟΔΗΓΙΩΝ ΕΓΚΑΤΑΣΤΑΣΗΣ

Για ασφάλεια και σωστή χρήση, παρακαλείστε διαβάσετε προσεκτικά αυτό το εγχειρίδιο εγκατάστασης πριν αρχίσετε την εγκατάσταση της μονάδας κλιματισμού.

4 [Fig. 4.0.1]

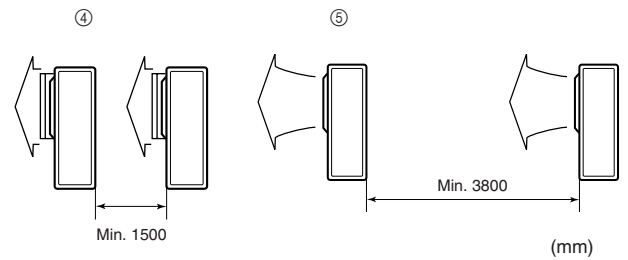
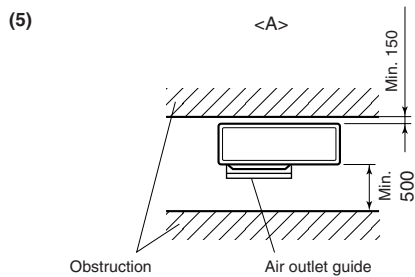
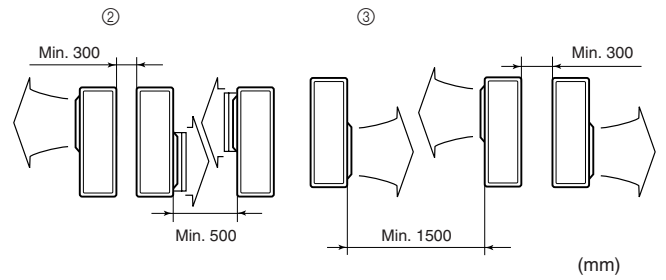
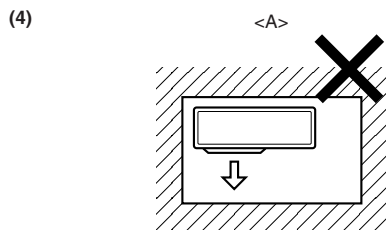
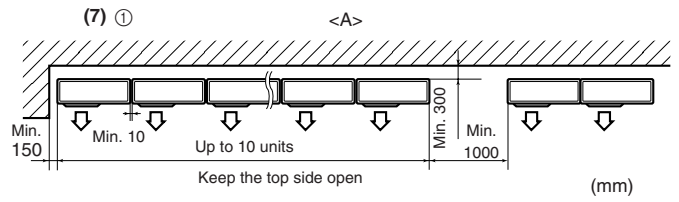
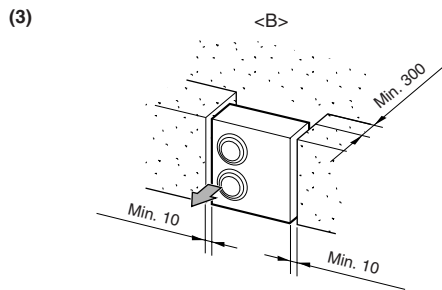
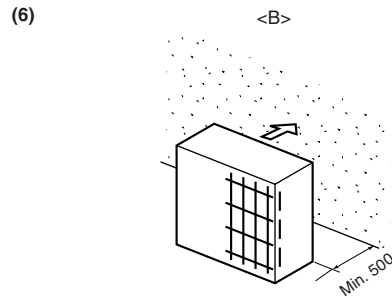
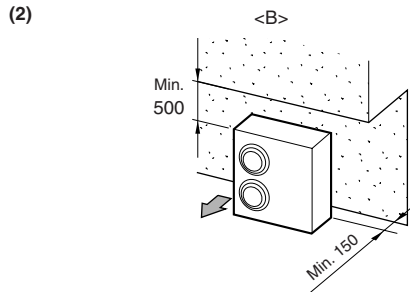
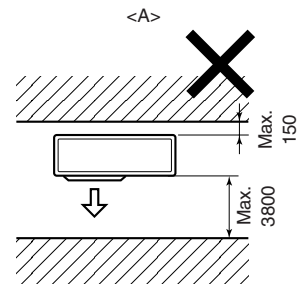
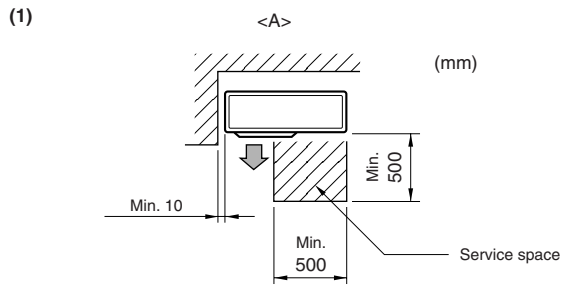

5 [Fig. 5.0.1]

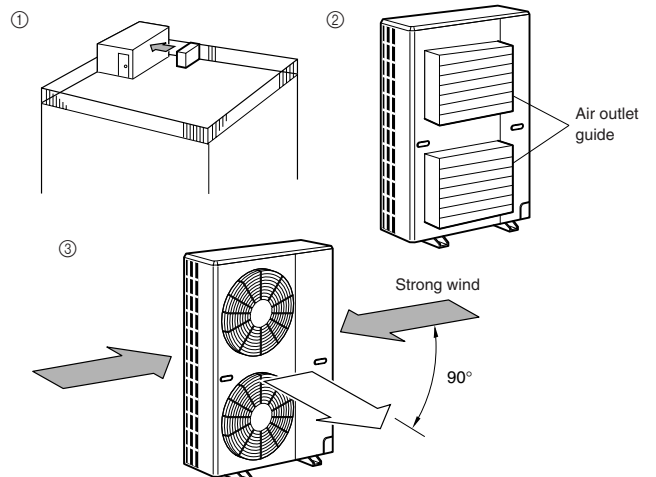
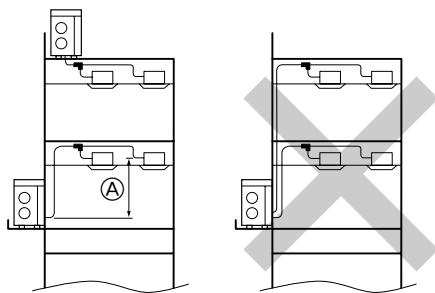

[Fig. 6.1.1]

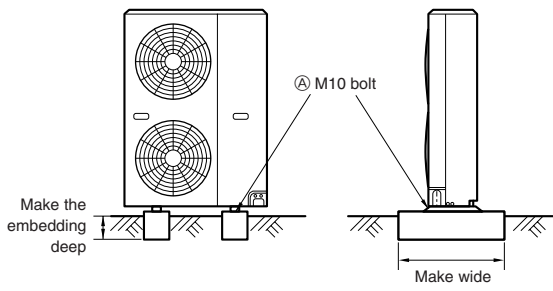

[Fig. 6.1.2]

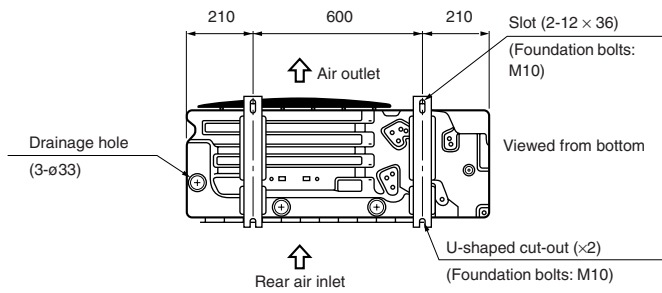
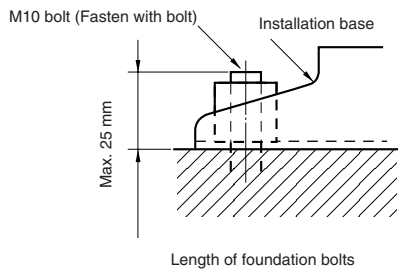
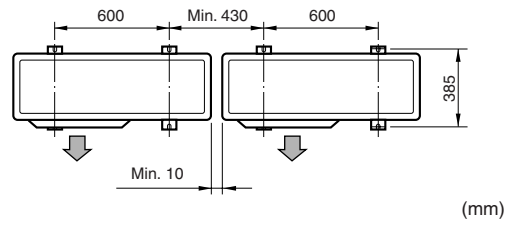

6.2

[Fig. 6.2.1]

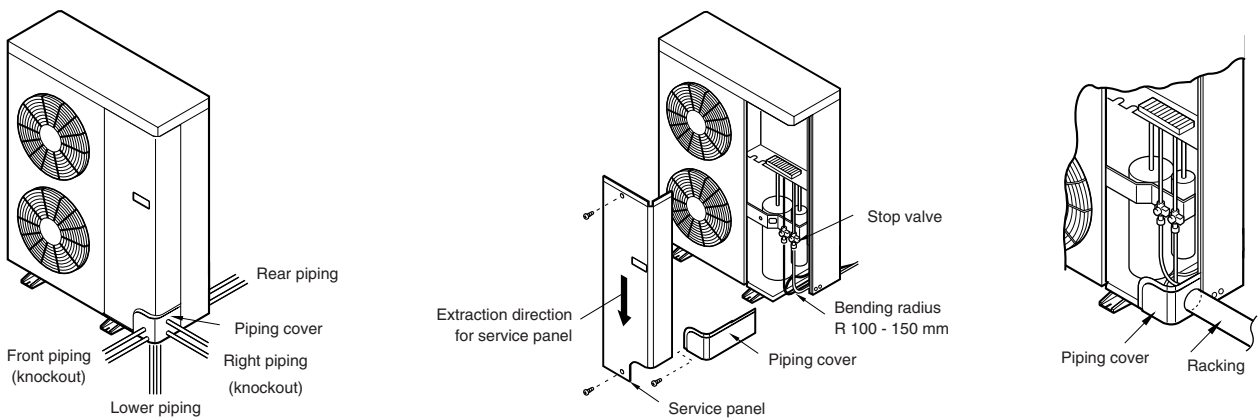

[Fig. 7.2.1]

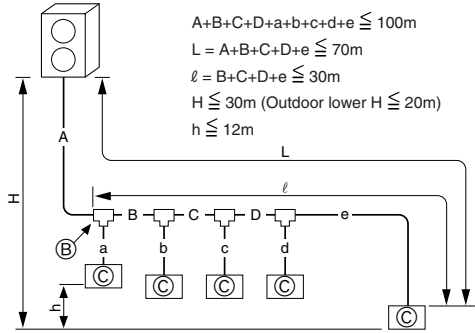

$A+B+C+D+a+b+c+d+e \leq 100m$
 $L = A+B+C+D+e \leq 70m$
 $\ell = B+C+D+e \leq 30m$
 $H \leq 30m$ (Outdoor lower $H \leq 20m$)
 $h \leq 12m$

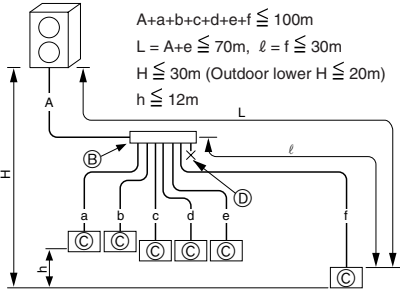

$A+a+b+c+d+e+f \leq 100m$
 $L = A+a \leq 70m, \ell = f \leq 30m$
 $H \leq 30m$ (Outdoor lower $H \leq 20m$)
 $h \leq 12m$

- Ⓐ: Outdoor Unit
- Ⓑ: First Branch
- Ⓒ: Indoor unit
- Ⓓ: Cap

A (mm)		
	Ⓐ Liquid pipe	Ⓑ Gas pipe
PUMY-P125	ø9.52	ø19.05

B, C, D (mm)		
Ⓒ Total capacity of indoor units	Ⓐ Liquid pipe	Ⓑ Gas pipe
~ 80	ø9.52	ø15.88
81 ~	ø9.52	ø19.05

a, b, c, d, e, f (mm)		
Ⓓ Model number	Ⓐ Liquid pipe	Ⓑ Gas pipe
20,25,32,40	ø6.35	ø12.7
50,63,80	ø9.52	ø15.88
100,125	ø9.52	ø19.05

Ⓔ Branch Kit Model	
CMY-Y62-C-E	

Ⓕ 4-Branching Header	Ⓖ 8-Branching Header
CMY-Y64-C	CMY-Y68

[Fig. 8.2.1]

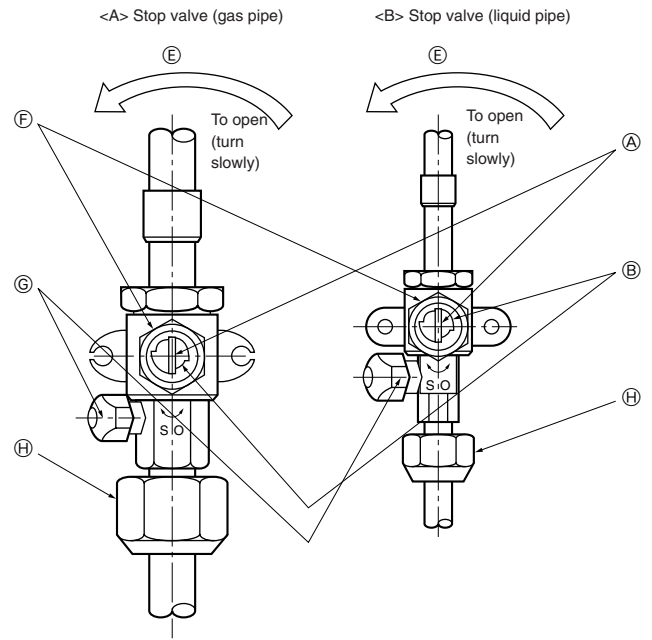

(This figure shows the handle when it is fully open.)

- Ⓐ: Valve stem
- Ⓑ: Stopper pin
- Ⓔ: Open (Operate slowly)
- Ⓕ: Cap, copper packing
- Ⓖ: Service port
- Ⓗ: Flare nut

[Fig. 8.2.2]

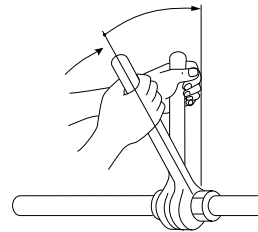

[Fig. 8.3.1]

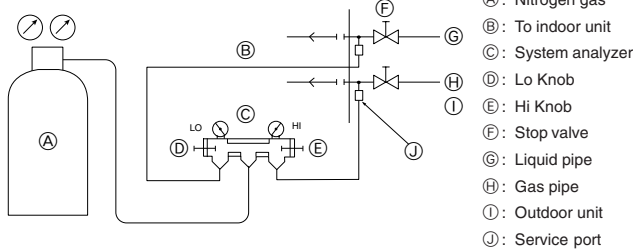

- Ⓐ: Nitrogen gas
- Ⓑ: To indoor unit
- Ⓒ: System analyzer
- Ⓓ: Lo Knob
- Ⓔ: Hi Knob
- Ⓕ: Stop valve
- Ⓖ: Liquid pipe
- Ⓗ: Gas pipe
- Ⓙ: Outdoor unit
- Ⓚ: Service port

[Fig. 8.3.3]

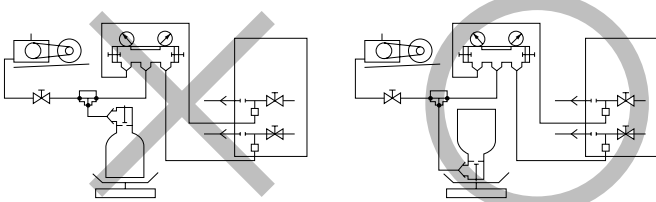

[Fig. 8.3.2]

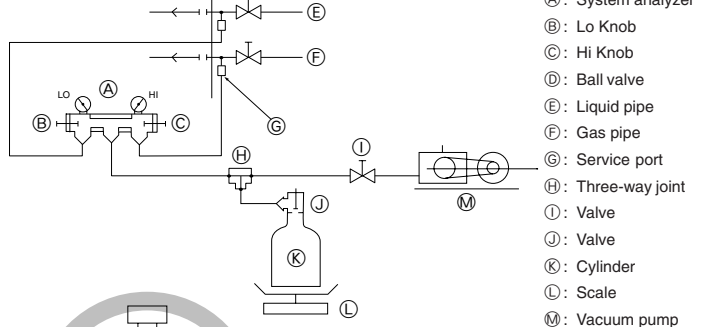

- Ⓐ: System analyzer
- Ⓑ: Lo Knob
- Ⓒ: Hi Knob
- Ⓓ: Ball valve
- Ⓔ: Liquid pipe
- Ⓕ: Gas pipe
- Ⓖ: Service port
- Ⓗ: Three-way joint
- Ⓙ: Valve
- Ⓚ: Valve
- Ⓛ: Cylinder
- Ⓜ: Scale
- Ⓝ: Vacuum pump

8.4

[Fig. 8.4.1]

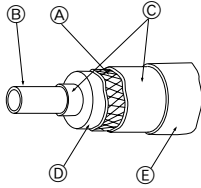

- (A): Steel wire
- (B): Piping
- (C): Asphaltic oily mastic or asphalt
- (D): Heat insulation material A
- (E): Outer covering B

[Fig. 8.4.2]

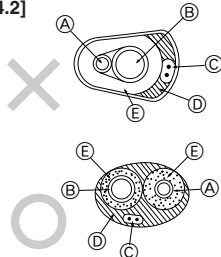

- (A): Liquid pipe
- (B): Gas pipe
- (C): Electric wire
- (D): Finishing tape
- (E): Insulator

[Fig. 8.4.3]

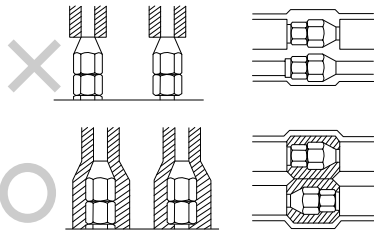

[Fig. 8.4.4]

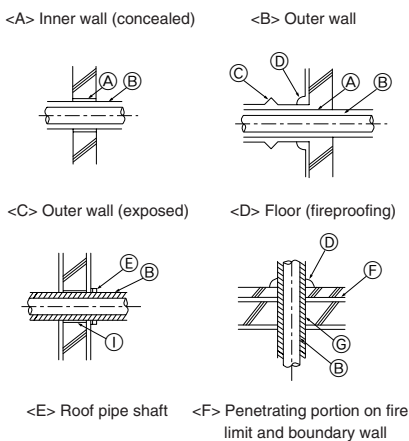

- (A): Sleeve
- (B): Heat insulating material
- (C): Lagging
- (D): Caulking material
- (E): Band
- (F): Waterproofing layer
- (G): Sleeve with edge
- (H): Lagging material
- (I): Mortar or other incombustible caulking
- (J): Incombustible heat insulation material

9

9.2

[Fig. 9.2.1]

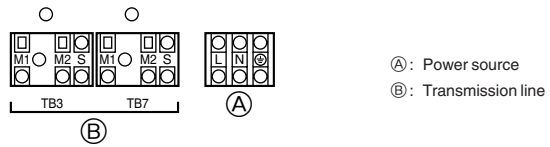

- (A): Power source
- (B): Transmission line

9.3

[Fig. 9.3.1]

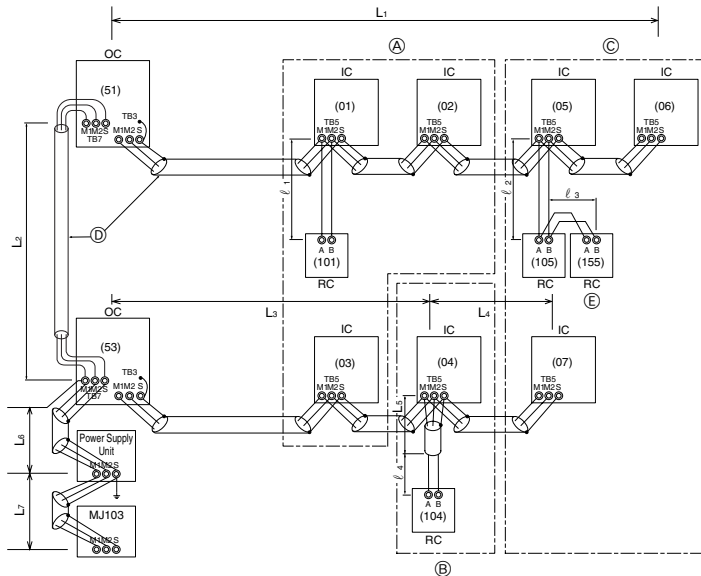

[Fig. 9.3.2]

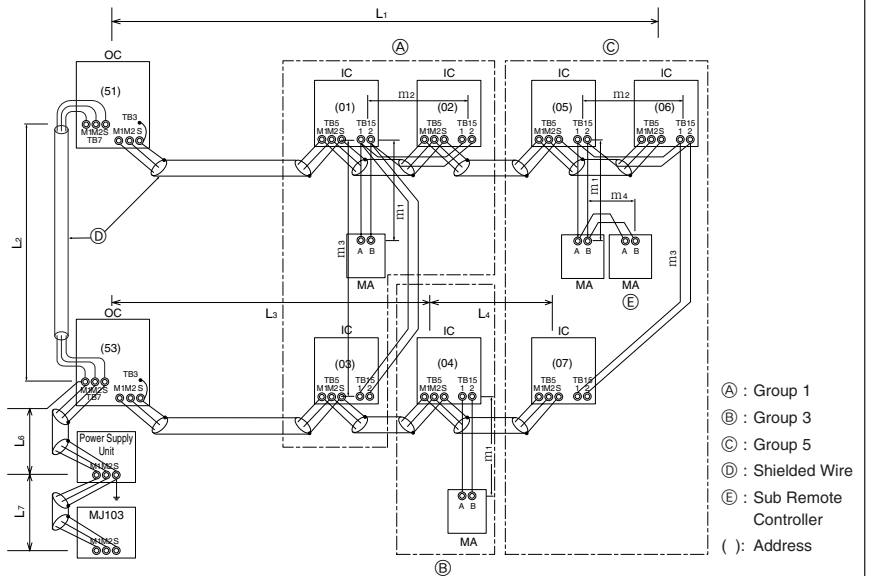

- (A): Group 1
- (B): Group 3
- (C): Group 5
- (D): Shielded Wire
- (E): Sub Remote Controller
- (): Address

9.4

[Fig. 9.4.1]

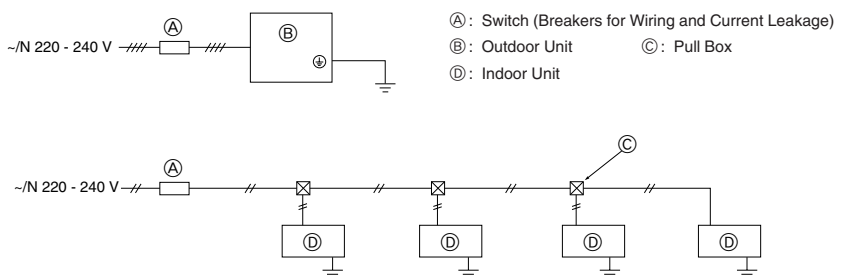

- (A): Switch (Breakers for Wiring and Current Leakage)
- (B): Outdoor Unit
- (C): Pull Box
- (D): Indoor Unit

1. Safety precautions	6	7.2. Refrigerant piping system	9
1.1. Before installation and electric work	6	8. Additional Refrigerant Charge	10
1.2. Precautions for devices that use R407C refrigerant	6	8.1. Calculation of Additional Refrigerant Charge	10
1.3. Before getting installed	7	8.2. Caution for piping connection/valve operation	10
1.4. Before getting installed (moved) - electrical work	7	8.3. Airtight test, evacuation, and refrigerant charging	10
1.5. Before starting the test run	7	8.4. Thermal insulation of refrigerant piping	11
2. Specifications	7	8.5. Pump down	12
3. Confirmation of parts attached	7	9. Wiring	12
4. Space required around unit	8	9.1. Caution	12
5. Selection of installation site	8	9.2. Control box and connecting position of wiring	12
6. Installation of unit	9	9.3. Wiring transmission cables	12
6.1. Installation	9	9.4. Wiring of main power supply and equipment capacity	13
6.2. Connecting direction for refrigerant piping	9	10. Test run	14
7. Refrigerant piping installation	9	10.1. The following phenomena do not represent trouble	
7.1. Caution	9	(emergency)	14

1. Safety precautions

1.1. Before installation and electric work





- ▶ Before installing the unit, make sure you read all the “Safety precautions”.
- ▶ Do not connect other electric appliances to the same supply lines.
- ▶ The “Safety precautions” provide very important points regarding safety. Make sure you follow them.

Symbols used in the text

 **Warning:**
Describes precautions that should be observed to prevent danger of injury or death to the user.

 **Caution:**
Describes precautions that should be observed to prevent damage to the unit.

Symbols used in the illustrations

-  : Indicates an action that must be avoided.
-  : Indicates that important instructions must be followed.
-  : Indicates a part which must be grounded.
-  : Beware of electric shock. (This symbol is displayed on the main unit label.)
<Color: yellow>

 **Warning:**
Carefully read the labels affixed to the main unit.

-  **Warning:**
- **Ask the dealer or an authorized technician to install the air conditioner.**
 - Improper installation by the user may result in water leakage, electric shock, or fire.
 - **Install the unit at a place that can withstand its weight.**
 - Inadequate strength may cause the unit to fall down, resulting in injuries.
 - **Use the specified cables for wiring. Make the connections securely so that the outside force of the cable is not applied to the terminals.**
 - Inadequate connection and fastening may generate heat and cause a fire.
 - **Prepare for strong winds and earthquakes and install the unit at the specified place.**
 - Improper installation may cause the unit to topple and result in injury.
 - **Always use an filter and other accessories specified by Mitsubishi Electric.**
 - Ask an authorized technician to install the accessories. Improper installation by the user may result in water leakage, electric shock, or fire.
 - **Never repair the unit. If the air conditioner must be repaired, consult the dealer.**
 - If the unit is repaired improperly, water leakage, electric shock, or fire may result.
 - **Do not touch the heat exchanger fins.**
 - Improper handling may result in injury.
 - **If refrigerant gas leaks during installation work, ventilate the room.**
 - If the refrigerant gas comes into contact with a flame, poisonous gases will be released.
 - **Install the air conditioner according to this Installation Manual.**
 - If the unit is installed improperly, water leakage, electric shock, or fire may result.
 - **Have all electric work done by a licensed electrician according to “Electric Facility Engineering Standard” and “Interior Wire Regulations” and the instructions given in this manual and always use a special circuit.**
 - If the power source capacity is inadequate or electric work is performed improperly, electric shock and fire may result.

- **Securely install the outdoor unit terminal cover (panel).**
 - If the terminal cover (panel) is not installed properly, dust or water may enter the outdoor unit and fire or electric shock may result.
- **When installing and moving the air conditioner to another site, do not charge the it with a refrigerant different from the refrigerant (R407C) specified on the unit.**
 - If a different refrigerant or air is mixed with the original refrigerant, the refrigerant cycle may malfunction and the unit may be damaged.
- **If the air conditioner is installed in a small room, measures must be taken to prevent the refrigerant concentration from exceeding the safety limit even if the refrigerant should leak.**
 - Consult the dealer regarding the appropriate measures to prevent the safety limit from being exceeded. Should the refrigerant leak and cause the safety limit to be exceeded, hazards due to lack of oxygen in the room could result.
- **Ventilate the room if refrigerant leaks during operation.**
 - If the refrigerant comes in contact with a flame, poisonous gases will be released.
- **When moving and reinstalling the air conditioner, consult the dealer or an authorized technician.**
 - If the air conditioner is installed improperly, water leakage, electric shock, or fire may result.
- **After completing installation work, make sure that refrigerant gas is not leaking.**
 - If the refrigerant gas leaks and is exposed to a fan heater, stove, oven, or other heat source, it may generate noxious gases.
- **Do not reconstruct or change the settings of the protection devices.**
 - If the pressure switch, thermal switch, or other protection device is shorted and operated forcibly, or parts other than those specified by Mitsubishi Electric are used, fire or explosion may result.
- **To dispose of this product, consult your dealer.**
- **The installer and system specialist shall secure safety against leakage according to local regulation or standards.**
 - Following standards may be applicable if local regulation are not available.
- **Pay a special attention to the place, such as a basement, etc. where refrigeration gas can stay, since refrigeration is heavier than the air.**
- **A switch with at least 3 mm contact separation in each pole shall be provided by the air conditioner installation.**

1.2. Precautions for devices that use R407C refrigerant

-  **Caution:**
- **Do not use the existing refrigerant piping.**
 - The old refrigerant and refrigerator oil in the existing piping contains a large amount of chlorine which may cause the refrigerator oil of the new unit to deteriorate.
 - **Use refrigerant piping made of phosphorus deoxidized copper and copper alloy seamless pipes and tubes. In addition, be sure that the inner and outer surfaces of the pipes are clean and free of hazardous sulphur, oxides, dust/dirt, shaving particles, oils, moisture, or any other contaminant.**
 - Contaminants on the inside of the refrigerant piping may cause the refrigerant residual oil to deteriorate.
 - **Store the piping to be used during installation indoors and keep both ends of the piping sealed until just before brazing. (Store elbows and other joints in a plastic bag.)**
 - If dust, dirt, or water enters the refrigerant cycle, deterioration of the oil and compressor trouble may result.
 - **Use ester oil, ether oil or alkylbenzene (small amount) as the refrigerator oil to coat flares and flange connections.**
 - The refrigerator oil will degrade if it is mixed with a large amount of mineral oil.
 - **Use liquid refrigerant to fill the system.**
 - If gas refrigerant is used to seal the system, the composition of the refrigerant in the cylinder will change and performance may drop.

- **Do not use a refrigerant other than R407C.**
 - If another refrigerant (R22, etc.) is used, the chlorine in the refrigerant may cause the refrigerator oil to deteriorate.
- **Use a vacuum pump with a reverse flow check valve.**
 - The vacuum pump oil may flow back into the refrigerant cycle and cause the refrigerator oil to deteriorate.
- **Do not use the following tools that are used with conventional refrigerants.**

(Gauge manifold, charge hose, gas leak detector, reverse flow check valve, refrigerant charge base, refrigerant recovery equipment)

 - If the conventional refrigerant and refrigerator oil are mixed in the R407C, the refrigerant may deteriorate.
 - If water is mixed in the R407C, the refrigerator oil may deteriorate.
 - Since R407C does not contain any chlorine, gas leak detectors for conventional refrigerants will not react to it.
- **Do not use a charging cylinder.**
 - Using a charging cylinder may cause the refrigerant to deteriorate.
- **Be especially careful when managing the tools.**
 - If dust, dirt, or water gets in the refrigerant cycle, the refrigerant may deteriorate.

1.3. Before getting installed

⚠ Caution:

- **Do not install the unit where combustible gas may leak.**
 - If the gas leaks and accumulates around the unit, an explosion may result.
- **Do not use the air conditioner where food, pets, plants, precision instruments, or artwork are kept.**
 - The quality of the food, etc. may deteriorate.
- **Do not use the air conditioner in special environments.**
 - Oil, steam, sulfuric smoke, etc. can significantly reduce the performance of the air conditioner or damage its parts.
- **When installing the unit in a hospital, communication station, or similar place, provide sufficient protection against noise.**
 - The inverter equipment, private power generator, high-frequency medical equipment, or radio communication equipment may cause the air conditioner to operate erroneously, or fail to operate. On the other hand, the air conditioner may affect such equipment by creating noise that disturbs medical treatment or image broadcasting.
- **Do not install the unit on a structure that may cause leakage.**
 - When the room humidity exceeds 80 % or when the drain pipe is clogged, condensation may drip from the indoor unit. Perform collective drainage work together with the outdoor unit, as required.

1.4. Before getting installed (moved) - electrical work

⚠ Caution:

- **Ground the unit.**
 - Do not connect the ground wire to gas or water pipes, lightning rods, or telephone ground lines. Improper grounding may result in electric shock.
- **The reverse phase of L lines (L1, L2, L3) and the reverse phase of L lines and N line can be not be detected.**
 - The some electric parts should be damaged when power is supplied under the miss wiring.

2. Specifications

Model	PUMY-P125VMA	
Noise level	54 dB <A>	
Net weight	127 kg	
Maximum refrigerant pressure	2.94 MPa	
External static pressure	0 Pa	
Indoor units	Total capacity	50 ~ 130 %
	Model / Quantity	20 ~ 125 / 1 ~ 8
Operation temperature	Cooling mode: - 5 °CDB ~ 46 °CDB Heating mode: - 12 °CWB ~ 15.5 °CWB	

3. Confirmation of parts attached

In addition to this manual, the following parts are supplied with the outdoor unit. They are used for group operation with more than two outdoor units. For details refer to page 13.



Grounding lead wire (x2) (green/yellow)

- **Install the power cable so that tension is not applied to the cable.**
 - Tension may cause the cable to break and generate heat and cause a fire.
- **Install an leak circuit breaker, as required.**
 - If an leak circuit breaker is not installed, electric shock may result.
- **Use power line cables of sufficient current carrying capacity and rating.**
 - Cables that are too small may leak, generate heat, and cause a fire.
- **Use only a circuit breaker and fuse of the specified capacity.**
 - A fuse or circuit breaker of a larger capacity or a steel or copper wire may result in a general unit failure or fire.
- **Do not wash the air conditioner units.**
 - Washing them may cause an electric shock.
- **Be careful that the installation base is not damaged by long use.**
 - If the damage is left uncorrected, the unit may fall and cause personal injury or property damage.
- **Install the drain piping according to this Installation Manual to ensure proper drainage. Wrap thermal insulation around the pipes to prevent condensation.**
 - Improper drain piping may cause water leakage and damage to furniture and other possessions.
- **Be very careful about product transportation.**
 - Only one person should not carry the product if it weighs more than 20 kg.
 - Some products use PP bands for packaging. Do not use any PP bands for a means of transportation. It is dangerous.
 - Do not touch the heat exchanger fins. Doing so may cut your fingers.
 - When transporting the outdoor unit, suspend it at the specified positions on the unit base. Also support the outdoor unit at four points so that it cannot slip sideways.
- **Safely dispose of the packing materials.**
 - Packing materials, such as nails and other metal or wooden parts, may cause stabs or other injuries.
 - Tear apart and throw away plastic packaging bags so that children will not play with them. If children play with a plastic bag which was not torn apart, they face the risk of suffocation.

1.5. Before starting the test run

⚠ Caution:

- **Turn on the power at least 12 hours before starting operation.**
 - Starting operation immediately after turning on the main power switch can result in severe damage to internal parts. Keep the power switch turned on during the operational season.
- **Do not touch the switches with wet fingers.**
 - Touching a switch with wet fingers can cause electric shock.
- **Do not touch the refrigerant pipes during and immediately after operation.**
 - During and immediately after operation, the refrigerant pipes are may be hot and may be cold, depending on the condition of the refrigerant flowing through the refrigerant piping, compressor, and other refrigerant cycle parts. Your hands may suffer burns or frostbite if you touch the refrigerant pipes.
- **Do not operate the air conditioner with the panels and guards removed.**
 - Rotating, hot, or high-voltage parts can cause injuries.
- **Do not turn off the power immediately after stopping operation.**
 - Always wait at least five minutes before turning off the power. Otherwise, water leakage and trouble may occur.

4. Space required around unit

[Fig. 4.0.1] (P.2)

<A> Top view

 Side view

(1) Basic space required

(2) When there is an obstruction above the unit

If there are no obstacles in front or at the left or right of the unit, obstacles above the unit are permitted as shown in the diagram.

- The front, right and left sides must be free of obstacles.

(3) When inlet air enters from right and left sides of unit

If the size of the space reserved for the unit is as shown in the diagram, the unit can be installed so that obstacles are at the right, left and rear.

- The front and top must be unobstructed.
- The height of obstacles on either side must be the same or lower than that of the outdoor unit.

(4) When unit is surrounded by walls

The unit cannot be used if there are obstacles on all 4 surrounding sides, even if there is more than the prescribed amount of space around the outdoor unit and if the top is unobstructed.

(5) Obstacles at the front & rear only

The outdoor unit cannot be used except if the following conditions are met: An optional outdoor air outlet guide (left/right & top unobstructed) must be fitted. Moreover, if there is no natural wind flowing between the obstacles, keep the height or width of the obstacles within the following range to prevent the risk of short cycling. (If either the front or rear satisfies the requirements, there is no special restriction on the remaining side).

Obstruction width: 1.5 times the width of outdoor unit or smaller

Obstruction height: Unit height or lower

(6) Obstacles in the front (blowing side) only

If there are obstacles in front of the unit, keep the back, left/right, & top unobstructed.

(7) When installing many outdoor units

① Side-by-side arrangement

Remove the side screw on the pipe cover.

Keep the top unobstructed.

- Refrigerant piping and electric wiring cannot be attached on the right side.

② Face-to-face arrangement (with air outlet guide)

Fit an optional outdoor air outlet guide on each unit and set them to "upward blow".

③ Face-to-face arrangement (without air outlet guides)

④ Parallel arrangement (with air outlet guides)

Fit an optional outdoor air outlet guide on each unit.

⑤ Parallel arrangement (without air outlet guides)

5. Selection of installation site

[Fig. 5.0.1] (P.2)

Select space for installing the outdoor unit, which will meet the following conditions:

- No direct thermal radiation from other heat sources
- No possibility of short cycle operations caused by exhaust heat from the unit
- No possibility of annoying neighbors by noise from the unit
- No exposure to strong wind
- No possibility of snow damage
- Fixture with strength which bears the weight of the unit
- Note that drain flows out of the unit when heating
- With space for air passage and service work shown opposite.

Because of the possibility of fire, do not install the unit to spaces where generation, inflow, stagnation, and leak of combustible gas is expected.

- Avoid unit installation in a place where acidic solutions and spray (sulfur) are often used.
- Take into account the following points if there are chances that cooling operation will be required when the outdoor temperature is **10°C or lower**. (Allowable outdoor temperature is -5°C.)
 - Do not install the outdoor unit in places where it may be exposed directly to rain, snow or wind.
 - If the above location is unavoidable, optional anti-snow ducts or air outlet guides must be installed.
 - Install the outdoor unit on the same floor or in a position higher than the indoor units.
 - In principle, the outdoor unit must be installed in a position higher than the indoor units. If the outdoor unit has to be installed in a position lower than the indoor units, keep the difference in height to within 4 m.

- Do not use the unit in any special environment where oil, steam and sulfuric gas exist.

Restriction on installing the outdoor unit to conduct cooling operation under the outdoor temperature of 10°C or less.

(At the same or above the floor on which the indoor unit is installed)

Ⓐ 4m or less

Precautions

Installation on a rooftop or other windy places

When installing the unit on a rooftop or other location unprotected from the wind, situate the unit's air outlet so that it is not directly exposed to strong winds. Strong wind entering the air outlet may impede the normal airflow and cause malfunctions.

The following shows three examples of precautions against strong winds.

- ① **Face the outlet toward any available wall at least 50 cm away from the wall.**
- ② **Install an optional air outlet guide and if the unit is installed at a place where the powerful blast of a typhoon, etc. comes directly into the air outlet.**
- ③ **Position the unit so that the air outlet blows perpendicularly to the seasonal wind direction, if possible.**

6. Installation of unit

6.1. Installation

[Fig. 6.1.1] (P.3)

Ⓐ M10 anchor bolt procured at the site.

- Fix unit tightly with bolts so that unit will not fall down due to earthquake or gust.
- Use concrete or angle for foundation of unit.
- Vibration may be transmitted to the installation section and noise and vibration may be generated from the floor and walls, depending on the installation conditions. Therefore, provide ample vibrationproofing (cushion pads, cushion frame, etc.).

⚠ Warning:

- **Be sure to install unit in a place strong enough to withstand its weight. Any lack of strength may cause unit to fall down, resulting in a personal injury.**
- **Have installation work in order to protect against a strong wind and earthquake.**

7. Refrigerant piping installation

Connecting the piping is a terminal-branch type in which refrigerant piping from the outdoor unit is branched at the terminal and connected to each of the indoor units.

For the piping of outdoor unit, flare connection must be used.

Note that the branched sections are brazed.

⚠ Warning:

Always use extreme care to prevent the refrigerant gas (R407C) from leaking while using fire or flame. If the refrigerant gas comes in contact with the flame from any source, such as a gas stove, it breaks down and generates a poisonous gas which can cause gas poisoning. Never weld in an unventilated room. Always conduct an inspection for gas leakage after installation of the refrigerant piping has been completed.

7.1. Caution

- ① Use the following materials for refrigeration piping.
 - Material: Use refrigerant piping made of phosphorus deoxidized copper. In addition, be sure that the inner and outer surfaces of the pipes are clean and free of hazardous sulphur, oxides, dust/dirt, shaving particles, oils, moisture, or any other contaminant.
- ② Commercially available piping often contains dust and other materials. Always blow it clean with a dry inert gas.
- ③ Use care to prevent dust, water or other contaminants from entering the piping during installation.
- ④ Reduce the number of bending portions as much as possible, and make bending radius as big as possible.
- ⑤ Always observe the restrictions on the refrigerant piping (such as rated length, the difference between high/low pressures, and piping diameter). Failure to do so can result in equipment failure or a decline in heating/cooling performance.
- ⑥ The City Multi Series Y will stop due an abnormality due to excessive or insufficient coolant. At such a time, always properly charge the unit. When servicing, always check the notes concerning pipe length and amount of additional refrigerant at both locations, the refrigerant volume calculation table on the back of the service panel and the additional refrigerant section on the labels for the combined number of indoor units.
- ⑦ **Use liquid refrigerant to fill the system.**
- ⑧ Never use refrigerant to perform an air purge. Always evacuate using a vacuum pump.
- ⑨ Always insulate the piping properly. Insufficient insulation will result in a decline in heating/cooling performance, water drops from condensation and other such problems.
- ⑩ When connecting the refrigerant piping, make sure the ball valve of the outdoor unit is completely closed (the factory setting) and do not operate it until the refrigerant piping for the outdoor and indoor units has been connected, a refrigerant leakage test has been performed and the evacuation process has been completed.
- ⑪ Always use a non-oxidizing brazing material for brazing the parts. If a non-oxidizing brazing material is not used, it could cause clogging or damage to the compressor unit.
- ⑫ **Never perform outdoor unit piping connection work when it is raining.**

Any installation deficiency may cause unit to fall down, resulting in a personal injury.

When building the foundation, give full attention to the floor strength, drain water disposal (>during operation, drain water flows out of the unit>), and piping and wiring routes.

Bolt pitch for side-by-side arrangement of units.

[Fig. 6.1.2] (P.3)

6.2. Connecting direction for refrigerant piping

[Fig. 6.2.1] (P.3)

⚠ Warning:

When installing and moving the unit, do not charge it with refrigerant other than the refrigerant specified on the unit.

- Mixing of a different refrigerant, air, etc. may cause the refrigerant cycle to malfunction and result in severe damage.

⚠ Caution:

- **Use a vacuum pump with the service port provided the outdoor unit's stop valve.**
 - If the vacuum pump does not have the service port, the vacuum pump oil may flow back into the refrigerant cycle and cause deterioration of the refrigerant oil and other trouble.
- **Do not use the tools shown below used with conventional refrigerant. (Gauge manifold, charge hose, gas leak detector, check valve, refrigerant charge base, vacuum gauge, refrigerant recovery equipment)**
 - Mixing of conventional refrigerant and refrigerator oil may cause the refrigerant oil to deteriorate.
 - Mixing of water will cause the refrigerator oil to deteriorate.
 - R407C refrigerant does not contain any chlorine. Therefore, gas leak detectors for conventional refrigerants will not react to it.
- **Manage the tools more carefully than normal.**
 - If dust, dirt, or water gets in the refrigerant cycle, the refrigerator oil will deteriorate.
- **Never use existing refrigerant piping.**
 - The large amount of chlorine in conventional refrigerant and refrigerator oil in the existing piping will cause the new refrigerant to deteriorate.
- **Store the piping to be used during installation indoors and keep both ends of the piping sealed until just before brazing.**
 - If dust, dirt, or water gets into the refrigerant cycle, the oil will deteriorate and the compressor may fail.
- **Do not use a charging cylinder.**
 - Using a charging cylinder may cause the refrigerant to deteriorate.
- **Do not use special detergents for washing piping.**

7.2. Refrigerant piping system

Connection Example

[Fig. 7.2.1] (P.4)

- | | |
|----------------------------------|----------------------|
| Ⓐ Liquid pipe | Ⓑ Gas pipe |
| Ⓒ Total capacity of indoor units | Ⓓ Model number |
| Ⓔ Branch Kit Model | Ⓕ 4-Branching Header |
| Ⓖ 8-Branching Header | |
| Ⓐ Outdoor Unit | Ⓑ First Branch |
| Ⓒ Indoor unit | Ⓓ Cap |

8. Additional Refrigerant Charge

Refrigerant of 3 kg equivalent to 50-m total extended piping length (model 125) is already included when the outdoor unit is shipped. Thus, if the total extended piping length is 50 m or less (model 125), there is no need to charge with additional refrigerant.

8.1. Calculation of Additional Refrigerant Charge

- If the total extended piping length exceeds 50 m (model 125), calculate the required additional refrigerant charge using the procedure shown below.
- If the calculated additional refrigerant charge is a negative amount, do not charge with any refrigerant.

<Additional Charge>

Additional refrigerant charge	=	Liquid pipe size Total length of ø9.52 × 0.06	+	Liquid pipe size Total length of ø6.35 × 0.024	-	Refrigerant amount for outdoor unit
(kg)		(m) × 0.06 (kg/m)		(m) × 0.024 (kg/m)		125: 3.0 kg

<Example>

Outdoor model : 125

Indoor 1 : 50	A : ø9.52	30 m	a : ø9.52	15 m	} At the conditions below:
2 : 40			b : ø6.35	10 m	
3 : 25			c : ø6.35	10 m	
4 : 20			d : ø6.35	20 m	

The total length of each liquid line is as follows

ø9.52 : A + a = 30 + 15 = 45 m

ø6.35 : b + c + d = 10 + 10 + 20 = 40 m

Therefore,

<Calculation example>

Additional

refrigerant charge = 45 × 0.06 + 40 × 0.024 - 3.0 = 0.7 kg (rounded up)

8.2. Caution for piping connection/valve operation

- Conduct piping connection and valve operation accurately.
- After evacuation and refrigerant charge, ensure that the handle is fully open. If operating with the valve closed, abnormal pressure will be imparted to the high- or low-pressure side of the refrigerant circuit, giving damage to the compressor, four-way valve, etc.
- Determine the amount of additional refrigerant charge by using the formula, and charge refrigerant additionally through the service port after completing piping connection work.
- After completing work, tighten the service port and cap securely not to generate gas leak.

[Fig. 8.2.1] (P.4)

<A> [Ball valve (gas side)]

(This figure shows the valve in the fully open state.)

 [Ball valve (liquid side)]

Ⓐ Valve stem

[Fully closed at the factory, when connecting the piping, when evacuating, and when charging additional refrigerant. Open fully after the operations above are completed.]

Ⓑ Stopper pin [Prevents the valve stem from turning 90° or more.]

Ⓒ Open (Operate slowly)

Ⓓ Cap, copper packing

[Remove the cap and operate the valve stem. Always reinstall the cap after operation is completed. (Valve stem cap tightening torque: 25 N-m (250 kg-cm) or more)]

Ⓔ Service port

[Use this port to evacuate the refrigerant piping and add an additional charge at the site.

Open and close the port using a double-ended wrench.

Always reinstall the cap after operation is completed. (Service port cap tightening torque: 14 N-m (140 kg-cm) or more)]

Ⓜ Flare nut

Loosen and tighten this nut using a double-ended wrench.

Coat the flare contact surface with refrigerator oil (Ester oil, ether oil or alkylbenzene [small amount]).]

Appropriate tightening torque by torque wrench:

Copper pipe external dia. (mm)	Tightening torque (N-m) / (kg-cm)
ø6.35	14 to 18 / 140 to 180
ø9.52	35 to 42 / 350 to 420
ø12.7	50 to 57.5 / 500 to 575
ø15.88	75 to 80 / 750 to 800
ø19.05	100 to 140 / 1000 to 1400

Tightening angle standard:

Pipe diameter (mm)	Tightening angle (°)
ø6.35, ø9.52	60 to 90
ø12.7, ø15.88	30 to 60
ø19.05	20 to 35

[Fig. 8.2.2] (P.4)

Note:

If a torque wrench is not available, use the following method as a standard: When you tighten the flare nut with a wrench, you will reach a point where the tightening torque will abruptly increase. Turn the flare nut beyond this point by the angle shown in the table above.

⚠ Caution:

- Always remove the connecting pipe from the ball valve and braze it outside the unit.
 - Brazing the connecting pipe while it is installed will heat the ball valve and cause trouble or gas leakage. The piping, etc. inside the unit may also be burned.
- Use ester oil, ether oil or alkylbenzene (small amount) as the refrigerator oil to coat flares and flange connections.
 - The refrigerator oil will degrade if it is mixed with a large amount of mineral oil.
- Tighten the flare nut with a torque wrench in the specified method.
 - Overtightening will cause the flare nut to crack and it will cause refrigerant leakage over a period of time.

8.3. Airtight test, evacuation, and refrigerant charging

① Airtight test

Perform with the stop valve of the outdoor unit closed, and pressurize the connection piping and the indoor unit from the service port provided on the stop valve of the outdoor unit. (Always pressurize from both the liquid pipe and the gas pipe service ports.)

[Fig. 8.3.1] (P.4)

Ⓐ Nitrogen gas	Ⓑ To indoor unit	Ⓒ System analyzer
Ⓓ Lo Knob	Ⓔ Hi Knob	Ⓕ Stop valve
Ⓔ Liquid pipe	Ⓖ Gas pipe	Ⓖ Outdoor unit
Ⓙ Service port		

<For R407C models>

The method of conducting the airtight test is basically the same as for R22 models. However, since the restrictions have a large affect on deterioration of the refrigerator oil, always observe them. Also, with nonazeotropic refrigerant (R407C, etc.), gas leakage causes the composition to change and affects performance. Therefore, perform the airtightness test cautiously.

Airtight test procedure	Restriction
<p>1. Nitrogen gas pressurization</p> <p>(1) Connect the testing tools.</p> <ul style="list-style-type: none"> • Make sure the stop valves are closed and do not open them. • Add pressure to the refrigerant lines through the service port of the liquid stop valve. <p>(2) Do not add pressure to the specified pressure all at once; add pressure little by little.</p> <p>① Pressurize to 0.5 MPa (5 kgf/cm²G), wait five minutes, and make sure the pressure does not decrease.</p> <p>② Pressurize to 1.5 MPa (15 kgf/cm²G), wait five minutes, and make sure the pressure does not decrease.</p> <p>③ Pressurize to 2.94 MPa (29.4 kgf/cm²G) and measure the surrounding temperature and refrigerant pressure.</p> <p>(3) If the specified pressure holds for about one day and does not decrease, the pipes have passed the test and there are no leaks.</p> <ul style="list-style-type: none"> • If the surrounding temperature changes by 1 °C, the pressure will change by about 0.01 MPa (0.1 kgf/cm²G). Make the necessary corrections. <p>(4) If the pressure decreases in steps (2) or (3), there is a gas leak. Look for the source of the gas leak.</p>	<ul style="list-style-type: none"> • If a flammable gas or air (oxygen) is used as the pressurization gas, it may catch fire or explode. • Do not use a refrigerant other than that indicated on the unit. • Sealing with gas from a cylinder will cause the composition of the refrigerant in the cylinder to change. • Use a pressure gauge, charge box, and other parts especially for R407C. • An electric leak detector for R22 cannot detect leaks of R407C. • Do not use a haloid torch. (Leaks cannot be detected.)

② Evacuation

Evacuate with the ball valve of the outdoor unit closed and evacuate both the connection piping and the indoor unit from the service port provided on the ball valve of the outdoor unit using a vacuum pump. (Always evacuate from the service port of both the liquid pipe and the gas pipe.) After the vacuum reaches 650 Pa [abs], continue evacuation for at least one hour or more.

* Never perform air purging using refrigerant.

[Fig. 8.3.2] (P.4)

- | | | |
|-------------------|-------------------|------------|
| Ⓐ System analyzer | Ⓑ Lo Knob | Ⓒ Hi Knob |
| Ⓓ Ball valve | Ⓔ Liquid pipe | Ⓕ Gas pipe |
| Ⓖ Service port | Ⓗ Three-way joint | Ⓖ Valve |
| Ⓙ Valve | Ⓚ Cylinder | Ⓛ Scale |
| Ⓜ Vacuum pump | | |

Note:

- **Always add an appropriate amount of refrigerant. Also always seal the system with liquid refrigerant. Too much or too little refrigerant will cause trouble.**
- **Use a gauge manifold, charging hose, and other parts for the refrigerant indicated on the unit.**
- **Use a gravimeter. (One that can measure down to 0.1 kg.)**

③ Refrigerant Charging (For R407C models)

Since the refrigerant used with the unit is nonazotropic, it must be charged in the liquid state. Consequently, when charging the unit with refrigerant from a cylinder, if the cylinder does not have a syphon pipe, charge the liquid refrigerant by turning the cylinder upside-down as shown below. If the cylinder has a syphon pipe like that shown in the figure at the right, the liquid refrigerant can be charged with the cylinder standing upright. Therefore, give careful attention to the cylinder specifications. If the unit should be charged with gas refrigerant, replace all the refrigerant with new refrigerant. Do not use the refrigerant remaining in the cylinder.

[Fig. 8.3.3] (P.4)

8.4. Thermal insulation of refrigerant piping

Be sure to give insulation work to refrigerant piping by covering liquid pipe and gas pipe separately with enough thickness heat-resistant polyethylene, so that no gap is observed in the joint between indoor unit and insulating material, and insulating materials themselves. When insulation work is insufficient, there is a possibility of condensation drip, etc. Pay special attention to insulation work to ceiling plenum.

[Fig. 8.4.1] (P.5)

- | | |
|------------------------------------|------------------------------|
| Ⓐ Steel wire | Ⓑ Piping |
| Ⓒ Asphaltic oily mastic or asphalt | Ⓓ Heat insulation material A |
| Ⓔ Outer covering B | |

Heat insulation material A	Glass fiber + Steel wire	
	Adhesive + Heat - resistant polyethylene foam + Adhesive tape	
Outer covering B	Indoor	Vinyl tape
	Floor exposed	Water-proof hemp cloth + Bronze asphalt
	Outdoor	Water-proof hemp cloth + Zinc plate + Oily paint

Note:

- **When using polyethylene cover as covering material, asphalt roofing shall not be required.**
- **No heat insulation must be provided for electric wires.**

[Fig. 8.4.2] (P.5)

- | | | |
|------------------|-------------|-----------------|
| Ⓐ Liquid pipe | Ⓑ Gas pipe | Ⓒ Electric wire |
| Ⓓ Finishing tape | Ⓔ Insulator | |

[Fig. 8.4.3] (P.5)

Penetrations

[Fig. 8.4.4] (P.5)

- | | |
|---|----------------------------|
| <A> Inner wall (concealed) | Outer wall |
| <C> Outer wall (exposed) | <D> Floor (fireproofing) |
| <E> Roof pipe shaft | |
| <F> Penetrating portion on fire limit and boundary wall | |
| Ⓐ Sleeve | Ⓑ Heat insulating material |
| Ⓒ Lagging | Ⓓ Caulking material |
| Ⓔ Band | Ⓕ Waterproofing layer |
| Ⓖ Sleeve with edge | Ⓗ Lagging material |
| Ⓙ Mortar or other incombustible caulking | |
| Ⓛ Incombustible heat insulation material | |

When filling a gap with mortar, cover the penetration part with steel plate so that the insulation material will not be caved in. For this part, use incombustible materials for both insulation and covering. (Vinyl covering should not be used.)

Example of a group operation system with multiple outdoor units (Shielding wires and address setting are necessary.)

<Examples of Transmission Cable Wiring>

[Fig. 9.3.1] M-NET Remote Controller (P.5)

[Fig. 9.3.2] MA Remote Controller (P.5)

- Ⓐ Group 1 Ⓑ Group 3 Ⓒ Group 5 Ⓓ Shielded Wire Ⓔ Sub Remote Controller
() Address

<Wiring Method and Address Settings>

- Always use shielded wire when making connections between the outdoor unit (OC) and the indoor unit (IC), as well for all OC-OC, and IC-IC wiring intervals.
- Use feed wiring to connect terminals M1 and M2 and the ground terminal on the transmission cable terminal block (TB3) of each outdoor unit (OC) to terminals M1, M2 and terminal S on the transmission cable block of the indoor unit (IC).
- Connect terminals 1 (M1) and 2 (M2) on the transmission cable terminal block of the indoor unit (IC) that has the most recent address within the same group to the terminal block on the remote controller (RC).
- Connect together terminals M1, M2 and terminal S on the terminal block for central control (TB7) for the outdoor unit (OC).
- On one outdoor unit only, change the jumper connector on the control panel from CN41 to CN40.
- Connect the terminal S on the terminal block for central control (TB7) for the outdoor unit (OC) for the unit into which the jumper connector was inserted into CN40 in Step above to the ground terminal (⊕) in the electrical component box.
- Set the address setting switch as follows.

Unit	Range	Setting Method
IC (Main)	01 to 50	Use the most recent address within the same group of indoor units
IC (Sub)	01 to 50	Use an address, other than that of the IC (Main) from among the units within the same group of indoor units. This must be in sequence with the IC (Main)
Outdoor Unit	51 to 100	Use the most recent address of all the indoor units plus 50 * The address automatically becomes "100" if it is set as "01 ~ 50".
M-NET R/C (Main)	101 to 150	Set at an IC (Main) address within the same group plus 100
M-NET R/C (Sub)	151 to 200	Set at an IC (Main) address within the same group plus 150
MA R/C	-	Unnecessary address setting (Necessary main/sub setting)

- The group setting operations among the multiple indoor units is done by the remote controller (RC) after the electrical power has been turned on.

<Permissible Lengths>

① M-NET Remote controller

- Max length via outdoor units: $L_1+L_2+L_3+L_4$ and $L_1+L_2+L_3+L_5$ and $L_1+L_2+L_6+L_7 \leq 500$ m (1.25 mm² or more)
- Max transmission cable length: L_1 and L_3+L_4 and L_3+L_5 and L_6 and L_2+L_6 and $L_7 \leq 200$ m (1.25 mm² or more)
- Remote controller cable length: $l_1, l_2, l_3, l_4 \leq 10$ m (0.3 to 1.25 mm²)
If the length exceeds 10 m, use a 1.25 mm² shielded wire. The length of this section (L_a) should be included in the calculation of the maximum length and overall length.

② MA Remote controller

- Max length via outdoor unit (M-NET cable): $L_1+L_2+L_3+L_4$ and $L_1+L_2+L_6+L_7 \leq 500$ m (1.25 mm² or more)
- Max transmission cable length (M-NET cable): L_1 and L_3+L_4 and L_6 and L_2+L_6 and $L_7 \leq 200$ m (1.25 mm² or more)
- Remote controller cable length: m_1 and $m_1+m_2+m_3$ and $m_1+m_2+m_3+m_4 \leq 200$ m (0.3 to 1.25 mm²)

9.4. Wiring of main power supply and equipment capacity

Schematic Drawing of Wiring (Example)

[Fig. 9.4.1] (P.5)

- Ⓐ Switch (Breakers for Wiring and Current Leakage) Ⓑ Outdoor Unit
Ⓒ Pull Box Ⓓ Indoor Unit

Thickness of Wire for Main Power Supply and On/Off Capacities

Model		Minimum Wire Thickness (mm ²)			Breaker for Wiring (NFB)	Breaker for Current Leakage
		Main Cable	Branch	Ground		
Outdoor Unit	P125	5.5 (6)	-	5.5 (6)	32 A	32 A 30 mA 0.1sec. or less
Indoor Unit		1.5	1.5	1.5	15 A	15 A 30 mA 0.1sec. or less

- Use a separate power supply for the outdoor unit and indoor unit.
- Bear in mind ambient conditions (ambient temperature, direct sunlight, rain water, etc.) when proceeding with the wiring and connections.
- The wire size is the minimum value for metal conduit wiring. The power cord size should be 1 rank thicker consideration of voltage drops.
Make sure the power-supply voltage does not drop more than 10 %.
- Specific wiring requirements should adhere to the wiring regulations of the region.
- Power supply cords of parts of appliances for outdoor use shall not be lighter than polychloroprene sheathed flexible cord (design 245 IEC57). For example, use wiring such as YZW.

⚠ Warning:

- Be sure to use specified wires to connect so that no external force is imparted to terminal connections. If connections are not fixed firmly, it may cause heating or fire.
- Be sure to use the appropriate type of overcurrent protection switch. Note that generated overcurrent may include some amount of direct current.

⚠ Caution:

- Some installation site may require attachment of an earth leakage breaker. If no earth leakage breaker is installed, it may cause an electric shock.
- Do not use anything other than breaker and fuse with correct capacity. Using fuse and wire or copper wire with too large capacity may cause a malfunction of unit or fire.

10. Test run

10.1. The following phenomena do not represent trouble (emergency)

Phenomenon	Display of remote controller	Cause
Indoor unit does not perform cooling (heating) operation.	"Cooling (heating)" flashes	When another indoor unit is performing the heating (cooling) operation, the cooling (heating) operation is not performed.
The auto vane runs freely.	Normal display	Because of the control operation of auto vane, it may change over to horizontal blow automatically from the downward blow in cooling in case the downward blow operation has been continued for 1 hour. At defrosting in heating, hot adjusting and thermostat OFF, it automatically changes over to horizontal blow.
Fan setting changes during heating.	Normal display	Ultra-low speed operation is commenced at thermostat OFF. Light air automatically changes over to set value by time or piping temperature at thermostat ON.
Fan stops during heating operation.	Defrost display	The fan is to stop during defrosting.
Fan does not stop while operation has been stopped.	No lighting	Fan is to run for 1 minute after stopping to exhaust residual heat (only in heating).
No setting of fan while start SW has been turned on.	Heat ready	Ultra low-speed operation for 5 minutes after SW ON or until piping temperature becomes 35°C, low speed operation for 2 minutes thereafter, and then set notch is commenced. (Hot adjust control)
Indoor unit remote controller shows "HO" indicator for about two minutes when turning ON universal power supply.	"HO" flashes	System is being driven. Operate remote controller again after "HO" disappears.
Drain pump does not stop while unit has been stopped.	Light out	After a stop of cooling operation, unit continues to operate drain pump for three minutes and then stops it.
Drain pump continues to operate while unit has been stopped.		Unit continues to operate drain pump if drainage is generated, even during a stop.

This product is designed and intended for use in the residential, commercial and light-industrial environment.

The product at hand is based on the following EU regulations:

- Low Voltage Directive 73/23/EEC
- Electromagnetic Compatibility Directive 89/336/EEC

Please be sure to put the contact address/telephone number on this manual before handing it to the customer.