



# Air-Conditioner Network System

## Centralized Controller GB-50ADA-A GB-50ADA-J

# Installation/Instructions Manual

• Safety notes are marked with **WARNING** or **CAUTION**, depending on the severity of possible consequences that may result when the instructions are not followed exactly as stated.  
Proper installation is important for your safety and proper functioning of the units. Thoroughly read the following safety precautions prior to installation.

To ensure safety and proper operation of the unit, the unit should only be installed by qualified personnel.

After reading this manual, pass the manual on to the end user to retain for future reference.



The users should keep this manual for future reference and refer to it as necessary. This manual should be made available to those who repair or relocate the units. Make sure that the manual is passed on to any future air condition system users.

## Contents

	Page
Safety Precautions .....	2
1. Introduction .....	5
1-1. Parts names and functions .....	5
1-2. Monitor and operation of the air conditioners.....	6
1-3. About “Group” and “Block” .....	6
2. Parts List .....	6
3. Specifications .....	7
3-1. Product Specifications .....	7
3-2. External dimensions.....	7
3-3. Supplying power to the M-NET transmission lines .....	8
4. System configuration .....	9
4-1. Setting M-NET address for various devices .....	10
4-2. M-NET system setting example .....	12
5. Installation .....	13
5-1. Field-supplied parts.....	13
5-2. M-NET transmission line length .....	14
5-3. Installation.....	15
6. Wiring connections.....	16
6-1. Installing and uninstalling the cover ..	16
6-2. Connecting the power cable and protective earth cable.....	16
6-3. Connecting the M-NET transmission line .....	17
6-4. Connecting the LAN cable .....	18
7. Initial settings .....	19
7-1. IP address and network settings.....	20
8. Product features.....	21
9. Test run .....	23
9-1. Batch operation/Stop (error reset) switches .....	23
9-2. Service LED display .....	23
10. External input/output .....	24
10-1. External signal input function .....	24
10-2. External signal output function.....	25
11. Copy to USB memory and read from USB memory .....	26
11-1. Switch setting .....	27
11-2. Operational data .....	28
12. 7-segment LED .....	30
12-1. 7-segment LED display and switch settings.....	31
13. Error code list.....	32

# Safety Precautions

- Thoroughly read the following safety precautions prior to installation.
- Observe these precautions carefully to ensure safety.

 <b>WARNING</b>	Indicates a risk of death or serious injury.
 <b>CAUTION</b>	Indicates a risk of injury or structural damage.

● Nomenclature









- After reading this manual, pass the manual on to the end user to retain for future reference.
- The users should keep this manual for future reference and refer to it as necessary. This manual should be made available to those who repair or relocate the units. Make sure that the manual is passed on to any future air condition system users.

**All electric work must be performed by qualified personnel.**



## General precautions



### WARNING

- Do not install the controller in a place where large amounts of oil, steam, organic solvents, or corrosive gases, such as sulfuric gas, are present or where acidic/alkaline solutions or sprays are used frequently. These substances can compromise the performance of the controller or cause certain components of the controller to corrode, which can result in electric shock, malfunctions, smoke, or fire. 
- To reduce the risk of shorting, current leakage, electric shock, malfunctions, smoke, or fire, do not wash the controller with water or any other liquid. 
- To reduce the risk of electric shock, malfunctions, smoke or fire, do not operate the switches/buttons or touch other electrical parts with wet hands. 

- To reduce the risk of injury or electric shock, before spraying a chemical around the controller, stop the operation and cover the controller. 
- To reduce the risk of injury or electric shock, stop the operation and switch off the power supply before cleaning, maintaining, or inspecting the controller. 
- Properly install all required covers to keep moisture and dust out of the controller. Dust accumulation and water can cause electric shock, smoke, or fire. 
- To reduce the risk of injury, keep children away while installing, inspecting, or repairing the controller. 

### CAUTION

- To reduce the risk of fire or explosion, do not place flammable materials or use flammable sprays around the controller. 
- To reduce the risk of damage to the controller, do not directly spray insecticide or other flammable sprays on the controller. 
- Do not touch the display panel, switches, or buttons with a sharp object. 
- To reduce the risk of injury and electric shock, avoid contact with sharp edges of certain parts. 

- To avoid injury from broken glass, do not apply excessive force on the glass parts. 
- To reduce the risk of injury, wear protective gear when working on the controller. 
- Always replace a fuse with the correct current rating. Using a fuse with the wrong rating or substituting a copper wire may cause a fire or explosion. 

## Precautions during installation

### ⚠ WARNING

Do not install the controller where there is a risk of leaking flammable gas. If flammable gas accumulates around the controller, it may ignite and cause a fire or explosion. 

Properly dispose of the packing materials. Plastic bags pose suffocation hazard to children. 

### ⚠ CAUTION

To reduce the risk of shorting, current leakage, electric shock, malfunctions, smoke, or fire, do not install the controller in a place exposed to water or in a condensing environment. 

Take appropriate safety measures against earthquakes to prevent the controller from causing injury. 

To prevent injury, install the controller on a flat surface strong enough to support its weight. 

Controller must be installed by qualified personnel according to the instructions detailed in the Installation Manual. Improper installation may result in electric shock or fire. 

## Precautions during wiring

### ⚠ WARNING

To reduce the risk of damage to the controller, malfunctions, smoke, or fire, do not connect the power cable to the signal terminal block. 

Properly secure the cables in place and provide adequate slack in the cables so as not to stress the terminals. Improperly connected cables may break, overheat, and cause smoke or fire. 

To reduce the risk of injury or electric shock, switch off the main power before performing electrical work. 

All electric work must be performed by a qualified electrician according to the local regulations, standards, and the instructions detailed in the Installation Manual. Capacity shortage to the power supply circuit or improper installation may result in malfunction, electric shock, smoke, or fire. 

Install an electric leakage breaker and a residual current circuit breaker on the power supply. 

Use properly rated breakers and fuses (breaker, local switch <switch + fuse>, no-fuse breaker). The use of a breaker with a breaking capacity greater than the specified capacity may cause electric shock, malfunctions, smoke, or fire. 

To reduce the risk of current leakage, overheating, smoke, or fire, use properly rated cables with adequate current carrying capacity. 

Proper grounding must be provided by a licensed electrician. Do not connect the grounding wire to a gas pipe, water pipe, lightning rod, or telephone wire. Improper grounding may result in electric shock, smoke, fire, or malfunction due to electrical noise interference. 

### ⚠ CAUTION

To reduce the risk of electric shock, shorting, or malfunctions, keep wire pieces and sheath shavings out of the terminal block. 

To reduce the risk of shorting, current leakage, electric shock, or malfunctions, keep the cables out of contact with controller edges. 

## Precautions for moving or repairing the controller

### ⚠ WARNING

The controller should be repaired or moved only by qualified personnel. Do not disassemble or modify the controller. Improper installation or repair may cause injury, electric shock, or fire. 

### ⚠ CAUTION

To reduce the risk of shorting, electric shock, fire, or malfunction, do not touch the circuit board with tools or with your hands, and do not allow dust to accumulate on the circuit board. 

## Additional precautions

To avoid damage to the controller, use appropriate tools to install, inspect, or repair the controller.

This controller is designed for exclusive use with the Building Management System by Mitsubishi Electric. The use of this controller for with other systems or for other purposes may cause malfunctions.

Take appropriate measures against electrical noise interference when installing the air conditioners in hospitals or facilities with radio communication capabilities. Inverter, high-frequency medical, or wireless communication equipment as well as power generators may cause the air conditioning system to malfunction. Air conditioning system may also adversely affect the operation of these types of equipment by creating electrical noise.

To avoid malfunctions, do not bundle power cables and signal cables together, or place them in the same metallic conduit.

To avoid damage to the controller, do not overtighten the screws.

To avoid damage to the controller, do not make holes on the controller cover.

To avoid deformation and malfunction, do not install the remote controller in direct sunlight or where the ambient temperature may exceed 55°C (131°F) or drop below -10°C (14°F).

Do not install the controller on the Control panel door. Vibrations or shocks to the controller may damage the controller or cause the controller to fall.

To prevent unauthorized access, always use a security device such as a VPN router when connecting to the Internet.

# 1 Introduction

GB-50ADA-A and GB-50ADA-J are centralized controllers that can be operated over the Web. Any connected air conditioning systems can be operated or monitored over the Web using browser software. Refer to the Web browser operation manual (separate volume) for how to use this functions. This manual covers the settings that can be made or functions that can be displayed only on the body of GB-50ADA-A or GB50ADA-J.

Hereinafter, GB-50ADA-A and GB-50ADA-J, unless otherwise specified, will be called "GB-50ADA."

## 1-1. Parts names and functions

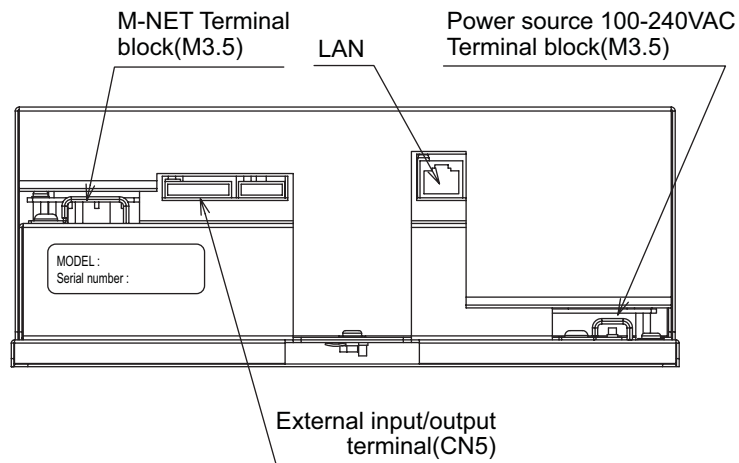
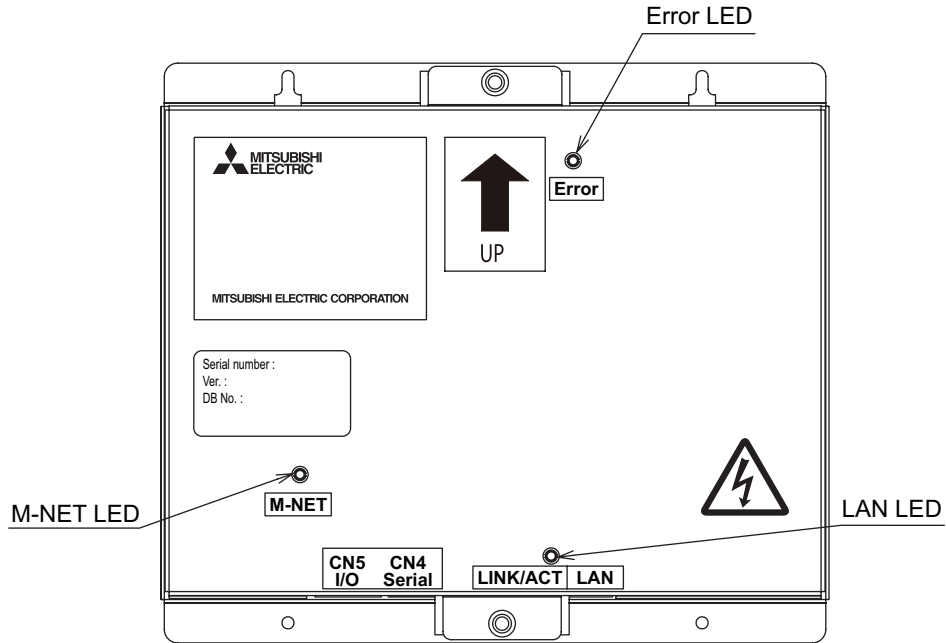

**1-2. Monitor and operation of the air conditioners**

To monitor and operate the air conditioners, license for “GB-50ADA Basic License Pack” or “Web Monitor” must be purchased and registered. Purchase the license from the dealer, and register on the Initial Setting Web or on the Web for Monitor and Operation. Refer to Web Browser Operation Manual for monitor and operation of air conditioners.

The format in which the Web page address for each GB-50ADA is expressed on the Web browser, as well as the default user name and password are shown below.

**http://[IP address of the GB-50ADA]/administrator.html**

Note: For example, type http://192.168.1.1/administrator.html if the GB-50ADA IP address is [192.168.1.1].

User	Default user name	Default password
Managers	administrator	admin

**Note**

- With the registration of “GB-50ADA Basic License Pack,” Web Monitor,” “Annual Schedule, Weekly Schedule,” “Sending Error Mail,” and “Maintenance Tool Advanced” functions will be available.
  - Consult the dealer for information on other functions that require a license (i.e. “Energy Management License Pack” “Personal Web”).
  - Initial settings such as making group changes are covered in the Initial Setting Web manual.
- The format in which the Web page address for each GB-50ADA is expressed on the Web browser, as well as the default user name and password are shown below.

**http://[IP address of the GB-50ADA]/g-50/administrator.html**

Note: For example, type “http://192.168.1.1/g-50/administrator.html” if the GB-50ADA IP address is [192.168.1.1].

User	Default user name	Default password
Maintenance user	initial	init

**1-3. About “Group” and “Block”**

The terms “Group” and “Block” used in this manual are defined as follows.

Group: Group is a group of air conditioning units and controllers and is the smallest unit that the GB-50ADA can control. The maximum number of units that each group can contain is 16.

Block: Block is a group of groups. Energy-save and peak-cut settings are made for each block.

**2 | Parts List**

The manual and the parts listed below are included in the box.

No.	Description	Qty.
①	Centralized controller	1
②	Installation/Instruction Manual (this Manual)	1
③	Instruction Book (Web browser for Initial Settings)	1
④	Instruction Book (Web browser for System maintenance engineer)	1

## 3 Specifications

### 3-1. Product Specifications

Items		Specifications	
Power source	Rated input	100-240VAC $\pm$ 10% 0.4-0.3A 50/60Hz	
	Fuse	250VAC 3.15A Time-delay Type (IEC127-2.S.S.5)	
Interface	Rated output of the power supply to M-NET transmission lines	22-30VDC	
	External input/output	12VDC or 24VDC (requires an external power supply)	
	LAN	100BASE-TX/10BASE-T	
	USB	USB1.1 supported	
Ambient conditions	Temperature	Operating temperature range	-10~55°C [14~131°F]
		Storage temperature range	-20~60°C [-4~140°F]
	Humidity		30 ~ 90%RH (Non-condensing)
Dimensions		217 (H) $\times$ 250 (W) $\times$ 97.2 (D) mm [8-9/16 (H) $\times$ 9-7/8 (W) $\times$ 3-7/8 (D) in.]	
Weight		2.6kg [5-3/4 lbs.]	
Installation conditions		Inside the metal control panel (indoor)	

### 3-2. External dimensions

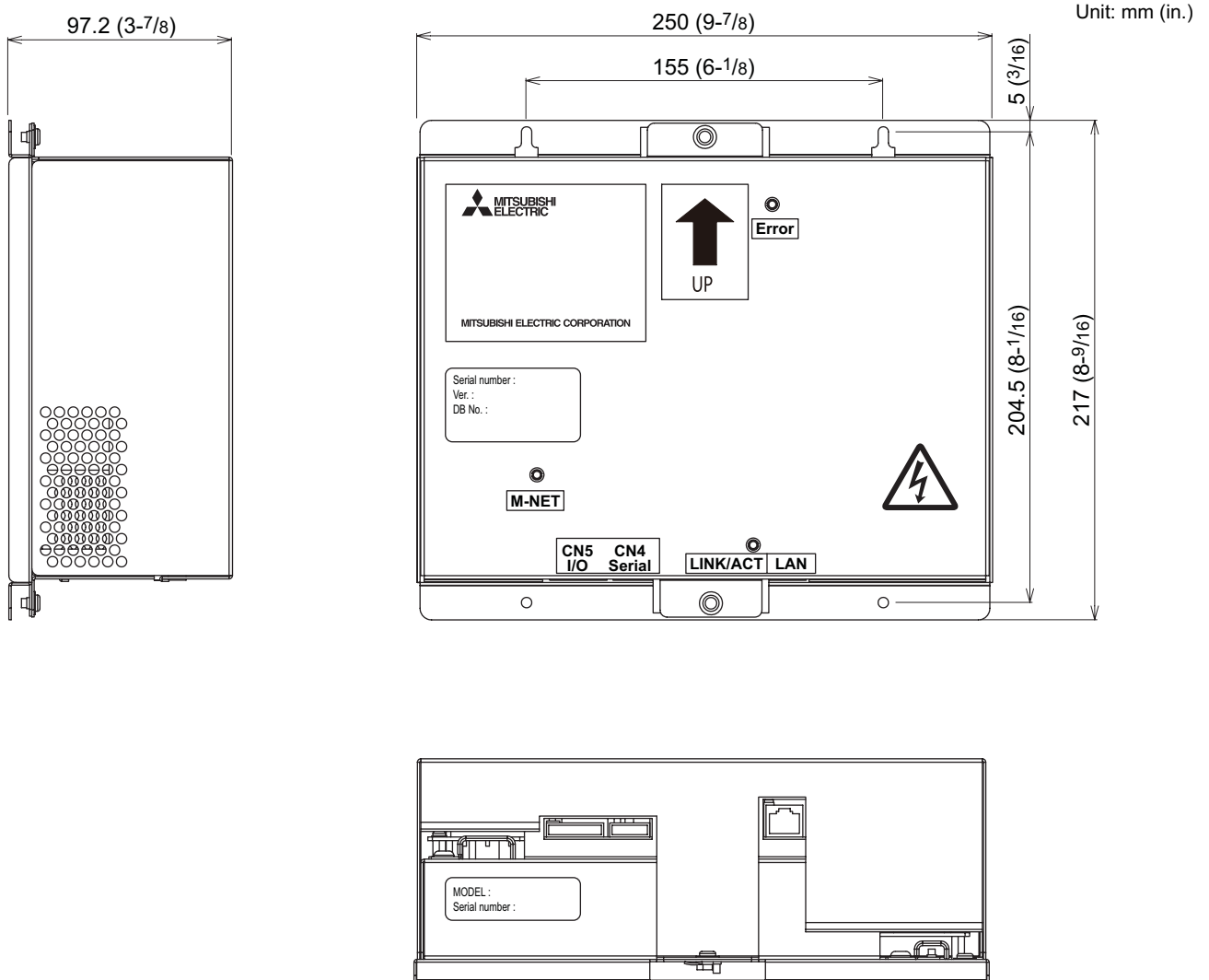

### 3-3. Supplying power to the M-NET transmission lines

GB-50ADA has a built-in function to supply power to the M-NET transmission line. (power supply coefficient: 6)

The total power consumption coefficient of the system controller and M-NET remote controller to which GB-50ADA supplies power (See table 1) should not exceed the power supply coefficient of GB-50ADA, which is six.

Table 1 Power consumption coefficient of the controller

System controller		M-NET remote controller
ON/OFF remote controller	System remote controller Schedule timer Group remote controller	ME remote controller LOSSNAY remote controller
1	0.5	0.25

Table 2 No. of connectable units

System controller		M-NET remote controller
ON/OFF remote controller	System remote controller Schedule timer Group remote controller	ME remote controller LOSSNAY remote controller
6 units	12 units	24 units

Table 3 No. of connectable units in systems with various combinations of remote controllers

V: connectable

		Total number of ON/OFF remote controllers						
		0	1	2	3	4	5	6
Total number of system remote controllers, schedule timers, and group remote controllers combined.	0	V	V	V	V	V	V	V
	1	V	V	V	V	V	V	
	2	V	V	V	V	V	V	
	3	V	V	V	V	V		
	4	V	V	V	V	V		
	5	V	V	V	V			
	6	V	V	V	V			
	7	V	V	V				
	8	V	V	V				
	9	V	V					
	10	V	V					
	11	V						
	12	V						

<b>Note</b>	<ul style="list-style-type: none"> <li>When connecting both GB-50ADA and BAC-HD150 (BM ADAPTER) to the same M-NET system, certain restrictions apply. Consult your dealer for details.</li> </ul>
-------------	---



# 4 System configuration

The figure below only shows the transmission line connections. Power supply lines are omitted.

Do not connect directly to the Internet. When connecting to the Internet, use a security device such as a VPN router.

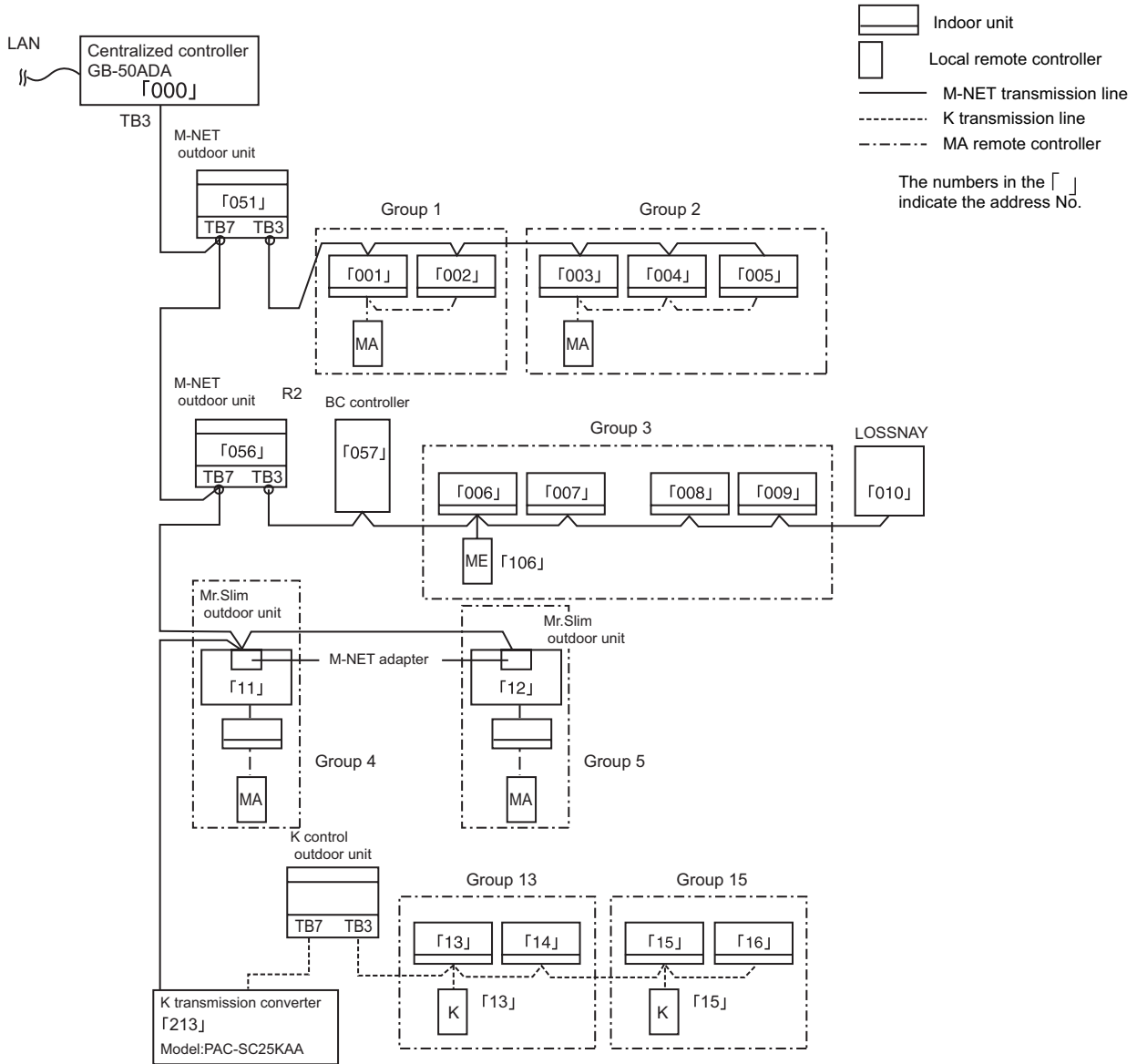

#### 4-1. Setting M-NET address for various devices

The same address cannot be used more than once within the same M-NET system of GB-50ADA.  
(K-control units and K-control remote control addresses are excluded.)

	Address setting method	M-NET address
Indoor unit	Assign the lowest address to the main indoor unit in the group, and assign sequential addresses to the rest of the indoor units in the same group.	1 ~ 50
Outdoor unit	Assign an address that equals the lowest indoor unit address in the same refrigerant group plus 50.	51 ~ 100
Auxiliary outdoor unit (BC controller etc.)	Assign an address that equals the address of the outdoor unit in the same refrigerant system plus 1.	52 ~ 100
OA processing unit/ LOSSNAY	Assign an arbitrary but unused address to each of these units after assigning an address to all indoor units.	1 ~ 50
Mr.Slim outdoor unit	Make the settings in the same way as with the indoor units. Requires an M-NET adapter (sold separately).	1 ~ 50
M-NET remote controller	Assign an address that equals the address of the main indoor unit with the lowest address in the group plus 100. Add 150 in stead of 100 to set the address for a sub remote controller.	101 ~ 200
MA remote controller	Address setting is not required. Connection of two remote controllers requires the main/sub setting for each controller to be made.	–
Sub system controller	Assign an address that equals the group number of the smallest controlled group plus 200.	201 ~ 250
DIDO controller (PAC-YG66DCA)	Assign an arbitrary but unused address to the controller after completing the address setting for the units with an address between 1 and 50. The number of controllable units changes with the number of channels used.	1 ~ 50
PI controller (PAC-YG60MCA)	Assign an arbitrary but unused address to the controller after completing the address setting for the units with an address between 1 and 50.	1 ~ 50
AI controller (PAC-YG63MCA)	Assign an arbitrary but unused address to the controller after completing the address setting for the units with an address between 1 and 50.	1 ~ 50
K-control indoor unit	Assign an address to all indoor units connected to the M-NET lines (incl. LOSSNAY units) first, and then assign addresses to the K-control indoor units, starting with the address after the last address.	1 ~ 50
K-control remote controller	Assign an address as the lowest address of the K-control indoor units in the same group.	1 ~ 50
K-transmission converter	Assign an address that equals the lowest K-control indoor unit address plus 200.	201 ~ 250

<b>Important</b>	<ul style="list-style-type: none"> <li>● Check that the setting for the central control switch SW2-1 on the M-NET outdoor unit is set to “ON.” (Refer to the outdoor unit Installation Manual for the detailed information about dip switch settings.)</li> <li>● Note the following when using a K-transmission converter (model: PAC-SC25KAA) to control the K-control units. Refer to the K-transmission converter Installation Manual for details.               <ol style="list-style-type: none"> <li>① Be sure to set the GB-50ADA address to “000.”</li> <li>② Set the “K-transmission converter connection setting” (to be set from a Main controller) to ON (with a connection to K-transmission converter). When this setting is set to ON, an address field will appear. Enter the K-transmission converter address in the field.</li> <li>③ Assign addresses to the K-control air conditioners so that they are larger than the addresses that are assigned to the M-control indoor units.</li> <li>④ Make the group settings for K-control units so that the group number equals the lowest address of the indoor units within the group.</li> <li>⑤ If the K-control Y series units and other types of units (K-control Mr. Slim) are used in combination, a relay board is required. The K-control Y series of units and other types of units cannot be connected to the same transmission line.</li> <li>⑥ A relay board may be required, depending on the number of K-control units and the length of transmission lines. Refer to the System Design Manual (control version) for details.</li> <li>⑦ LOSSNAY units that are connected to the general K-control kit cannot be connected.</li> <li>⑧ Remote controller addresses is not required in the group setting for the K-control models.</li> </ol> </li> </ul>
<b>Note</b>	<ul style="list-style-type: none"> <li>● A-control jet burner models cannot be controlled.</li> <li>● Some models cannot be controlled.</li> <li>● Main system controllers, such as the AG-150A, cannot be connected to a M-NET system that is controlled by the GB-50ADA.</li> <li>● When connecting both GB-50ADA and BAC-HD150 (BM ADAPTER) to the same M-NET system, certain restrictions apply. Consult your dealer for details.</li> </ul>

\* Main and Sub system controllers (M-NET)  
 GB-50ADA can be used only as the Main controller, not as a Sub controller.

- Main system controller (Main SC)  
 Main SC refers to a controller that controls all other system controllers including the units they control. If a given system has only one system controller, that controller becomes a Main controller. Group settings and interlock settings can be made only from a Main controller.
- Sub system controller (Sub SC)  
 Sub controller refers to a system controller that is controlled (including the units it controls) by a Main system controller.

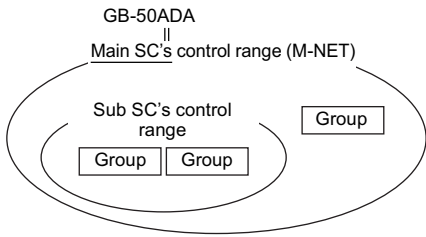

GB-50ADA is exclusively for use as a Main SC. It cannot be used as a Sub SC or controlled from a Main SC.

**Note**

- Groups that are not under the control of a Main controller cannot be controlled from a Sub controller.

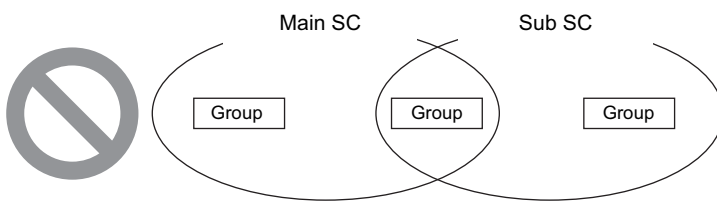

- Each group cannot be placed under the control of two or more Main controllers.

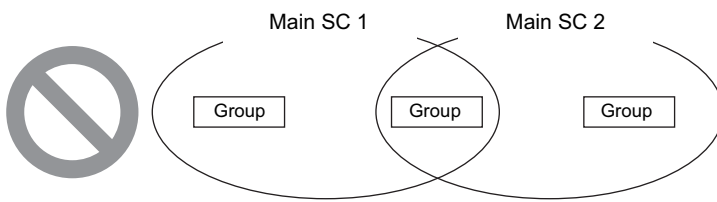

- Sub controllers cannot be placed under the control of two or more Main controllers.

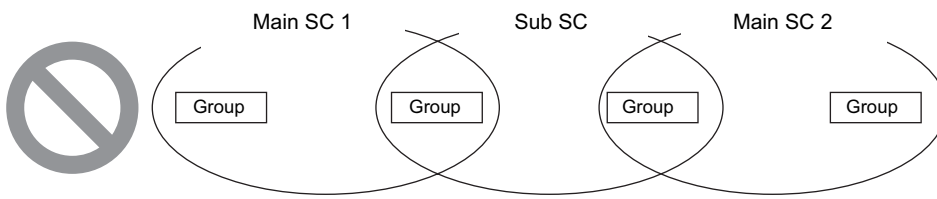

## 4-2. M-NET system setting example

### ① Connecting multiple M-NET system controllers

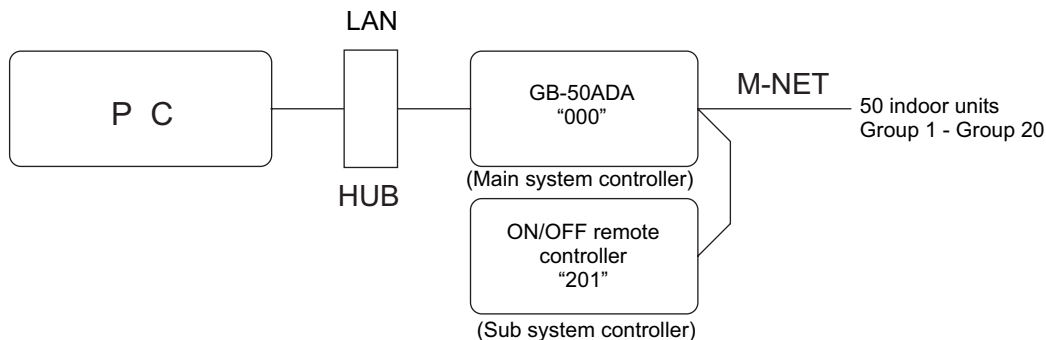

- Make the initial setting such as group setting or interlock setting using the Initial Setting Web on GB-50ADA.
- Designate a system controller within the system as the only controller from which operation prohibit setting can be made.

### ② Controlling Mr. Slim (A-control models)

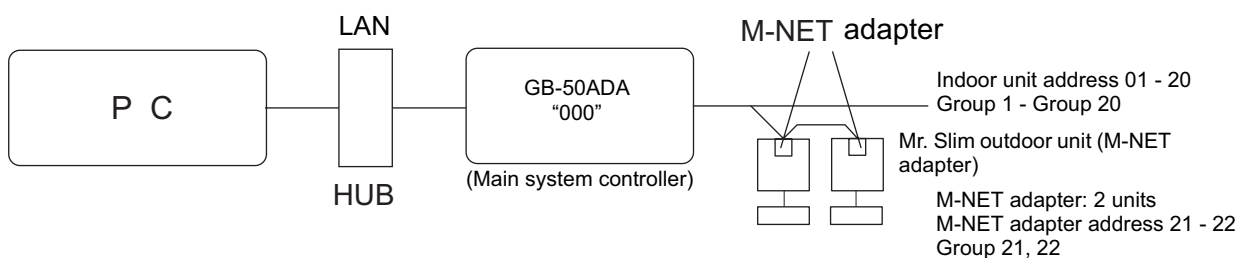

- An M-NET adapter (sold separately) is required to connect and control the Mr. Slim model of units to the M-NET.

### ③ Controlling the K-control models

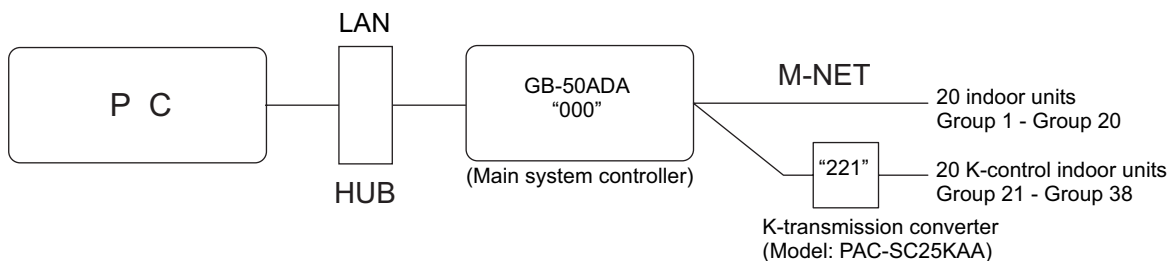

- Set the GB-50ADA address to "000" when connecting a K-transmission converter.
- When making the group setting for K-control units, make the setting only for the indoor units that belong to a given group.
- The group number given to a group of K-control units should be the same as the lowest address of the indoor units that belong to the group.
- If the K-control Y series units and other types of units (K-control Mr. Slim) are used in combination, a relay board is required. The K-control Y series units cannot be connected to the same transmission lines as the other types of units.
- Depending on the number of K-control units and transmission line length, a relay board may be required. Refer to the System Design/Manual (control version) for details.
- LOSSNAY units cannot be connected if they are connected to the K-control kit.
- Remote controller addresses do not need to be included in the group setting for a group of K-control units.

## 5 Installation

### 5-1. Field-supplied parts

The following parts are required to install the unit.

Required parts	Specification								
Power cable/ protective earth cable	Power supply cable of appliances shall not be lighter than design 245 IEC 57 or 227 IEC 57. Cable size: 0.75mm <sup>2</sup> to 2mm <sup>2</sup>								
M-NET transmission line	Shielded cable • CPEVS: $\phi$ 1.2mm to $\phi$ 1.6mm • CVVS: 1.25mm <sup>2</sup> to 2mm <sup>2</sup>								
Ring terminal (with a sleeve)	M3.5 terminal (used with the power cable (L/L1, N/L2), M-NET transmission line (A, B, S)) M4 ring terminal (used with the protective earth cable)								
Screw	Have four M4 screws ready to install the unit.								
LAN cable	Category 5 or above straight cable (Maximum 100m (328 ft))								
HUB	Switching HUB (communication speed: 100 Mbps or faster is recommended.)								
Overcurrent breaker and Residual Current Circuit Breaker (RCCB)	<table border="1"> <thead> <tr> <th colspan="2">Overcurrent breaker</th> <th>Residual Current Circuit Breaker (RCCB)<sup>*1 *3</sup></th> </tr> </thead> <tbody> <tr> <td>Fuse</td> <td>Circuit breaker<sup>*1</sup></td> <td rowspan="2">Rated sensitivity current: 30mA Maximum operation time: 0.1 sec or less</td> </tr> <tr> <td>Rated current: 3A<sup>*2</sup></td> <td>Rated current: 3A</td> </tr> </tbody> </table> <p>*1 Use a Circuit breaker and a Residual current circuit breaker (RCCB) of bipolar type (2P2E). Use a breaker with the minimum contact distance of 3 mm (1/8 in.). *2 When using a fuse, use it in combination with a main switch (Rated current: 3A). *3 Normally, maximum leakage current of one GB-50ADA is 2 mA. Select and install the earth leakage breaker, considering the rated current of overcurrent breaker and the leakage current of power cables.</p>	Overcurrent breaker		Residual Current Circuit Breaker (RCCB) <sup>*1 *3</sup>	Fuse	Circuit breaker <sup>*1</sup>	Rated sensitivity current: 30mA Maximum operation time: 0.1 sec or less	Rated current: 3A <sup>*2</sup>	Rated current: 3A
Overcurrent breaker		Residual Current Circuit Breaker (RCCB) <sup>*1 *3</sup>							
Fuse	Circuit breaker <sup>*1</sup>	Rated sensitivity current: 30mA Maximum operation time: 0.1 sec or less							
Rated current: 3A <sup>*2</sup>	Rated current: 3A								

## 5-2. M-NET transmission line length

- Connect the GB-50ADA to the transmission line for centralized control (TB7 on the outdoor unit).
- There should only be one power supply source within a single M-NET transmission circuit. The factory setting is to supply power from GB-50ADA.
- Provide an earth for the indoor-outdoor transmission lines at one single outdoor unit.
- Maximum line distance 500 m (1640 ft)<sup>\*1</sup>
- Maximum power supply distance 200 m (656 ft)<sup>\*1</sup>

Maximum power supply distance is the distance in which a power supply unit (or an outdoor unit designated as a power supply unit) is capable of supplying power to other units on the receiving end, such as remote controllers and indoor units.

Wiring example

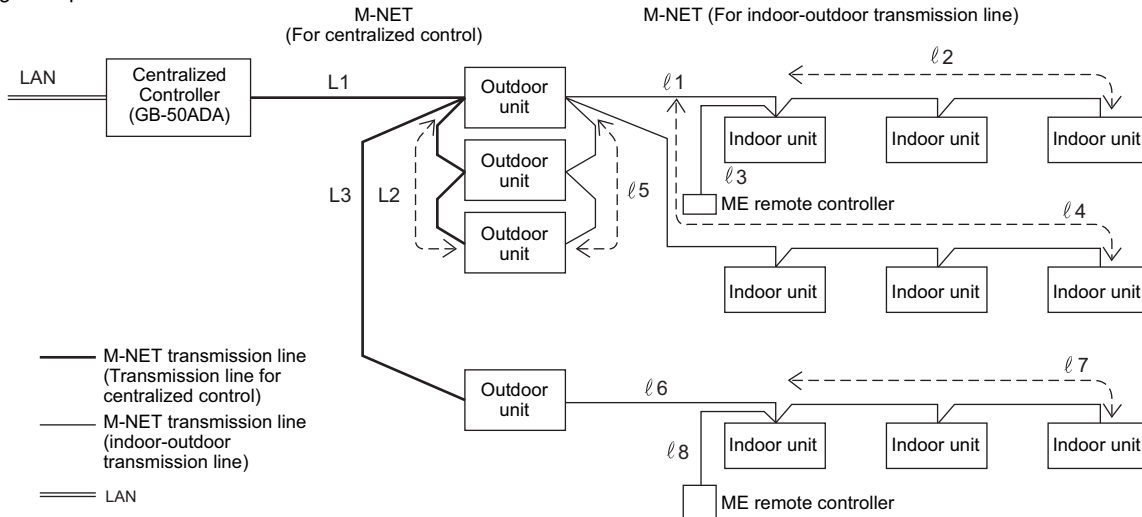

### (1) Maximum line distance

- |  |                              |
|--|------------------------------|
| ① $L1 + L2 + l5 + l1 + l2$ ( $l3$ )                      | $\leq 500\text{m}$ (1640 ft) |
| ② $L1 + L2 + l5 + l4$                                    | $\leq 500\text{m}$ (1640 ft) |
| ③ $L1 + L3 + l6 + l7$ ( $l8$ )                           | $\leq 500\text{m}$ (1640 ft) |
| ④ $l2$ ( $l3$ ) + $l1 + l5 + L2 + L3 + l6 + l7$ ( $l8$ ) | $\leq 500\text{m}$ (1640 ft) |
| ⑤ $l4 + l5 + L2 + L3 + l6 + l7$ ( $l8$ )                 | $\leq 500\text{m}$ (1640 ft) |

\* Connect the power jumper of the outdoor unit to CN41 (does not supply power).

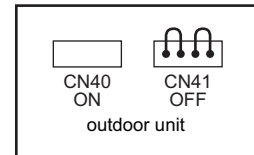

### (2) Power supply distance for the indoor-outdoor transmission lines

- |                           |                             |
|---------------------------|-----------------------------|
| ① $l5 + l1 + l2$ ( $l3$ ) | $\leq 200\text{m}$ (656 ft) |
| ② $l5 + l4$               | $\leq 200\text{m}$ (656 ft) |
| ③ $l6 + l7$ ( $l8$ )      | $\leq 200\text{m}$ (656 ft) |

### (3) Power supply distance for the centralized control transmission lines

- |             |                             |
|-------------|-----------------------------|
| ① $L1 + L2$ | $\leq 200\text{m}$ (656 ft) |
| ② $L1 + L3$ | $\leq 200\text{m}$ (656 ft) |

### CAUTION

- \*1 The ME remote controller wiring length ( $l3$ ,  $l8$ ) should be 10 m (32 ft) or less. The length that exceeds 10 m (32 ft) needs to be included in the maximum distance to the farthest unit (500 m (1640 ft)) and in the maximum power supply distance (200 m (656 ft)).
- \*2 If the ME remote controller wiring length ( $l3$ ,  $l8$ ) is 10 m (32 ft) or less, it does not need to be included in the maximum distance to the farthest unit.

### 5-3. Installation

- Leave enough space around the unit as shown in the figure below to allow for an installation/uninstallaion of the cover and wiring.
- Screw down the cover with M4 screws as shown in the figure below.  
Be sure to screw down the four corners to prevent it from falling.
- Install on the metal control panel whose effective depth is 105 mm (4-3/16 in.) or more.

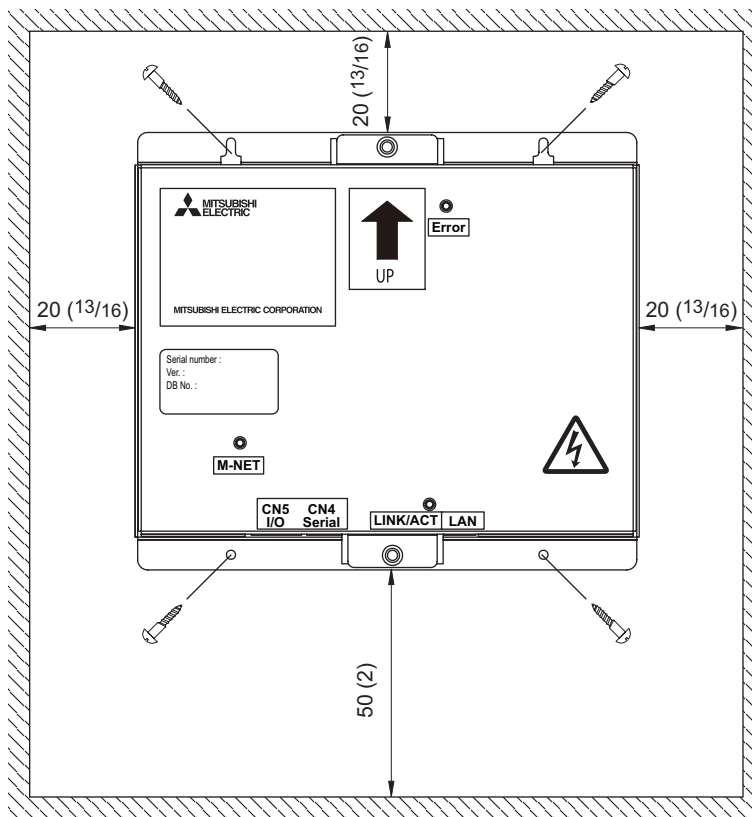

Unit: mm (in.)

\* Refer to section [3](#) Specifications for the product dimensions and weight.

**Properly install the unit on a stable, load-bearing surface.**  
Unit installed on an unstable surface may fall and cause injury.

**To reduce the risk of fire and malfunctions and to keep the unit from falling, do not install the unit where the unit may receive vibration or mechanical shock.**

#### Important :

**GB-50ADA is not water-proof.**  
Be sure to install it inside the control panel.

**Be sure to install it inside the control panel. Be sure to install in an area where there is no possibility of dew condensation.**

## 6 Wiring connections

### ⚠ WARNING

- Electric work must be performed by an authorized technician. Improper wiring work may result in electric shock or fire.
- Turn off the power supply before performing wiring work.

### ⚠ CAUTION

- To avoid damage to the terminal block, do not connect an AC power supply (100-240VAC) to the M-NET transmission terminal block.

### 6-1. Installing and uninstalling the cover

Unscrew the two screws on the cover to remove it as shown in the figure below.  
Reinstall the cover using the two screws that were unscrewed.

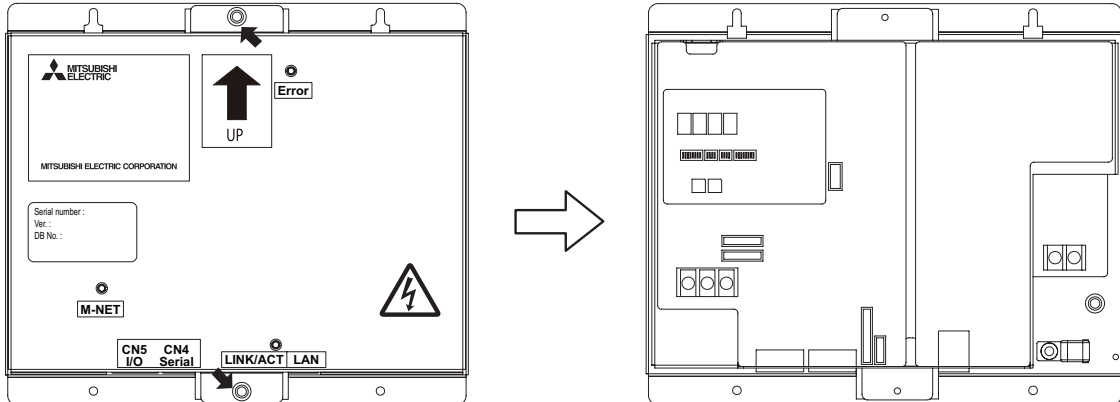

### 6-2. Connecting the power cable and protective earth cable

**To prevent overheating and fire, properly fix the cables in place so that the weight of the cables will not strain the connectors.**

Improperly connected cables may break, produce heat, and cause smoke or fire.

- Connect the power cable and the protective earth cable as shown in the figure below.
- Use an M3.5 ring terminal to the power cable and an M4 ring terminal to the protective earth cable before connecting them to their corresponding terminals (power supply terminal block or protective earth terminal).
- Secure cables with cable clamps.
- Install an overcurrent breaker and a residual current circuit breaker for the power cable. Use a bipolar breaker (2P2E) with a minimum contact distance of 3 mm (1/8 in.).

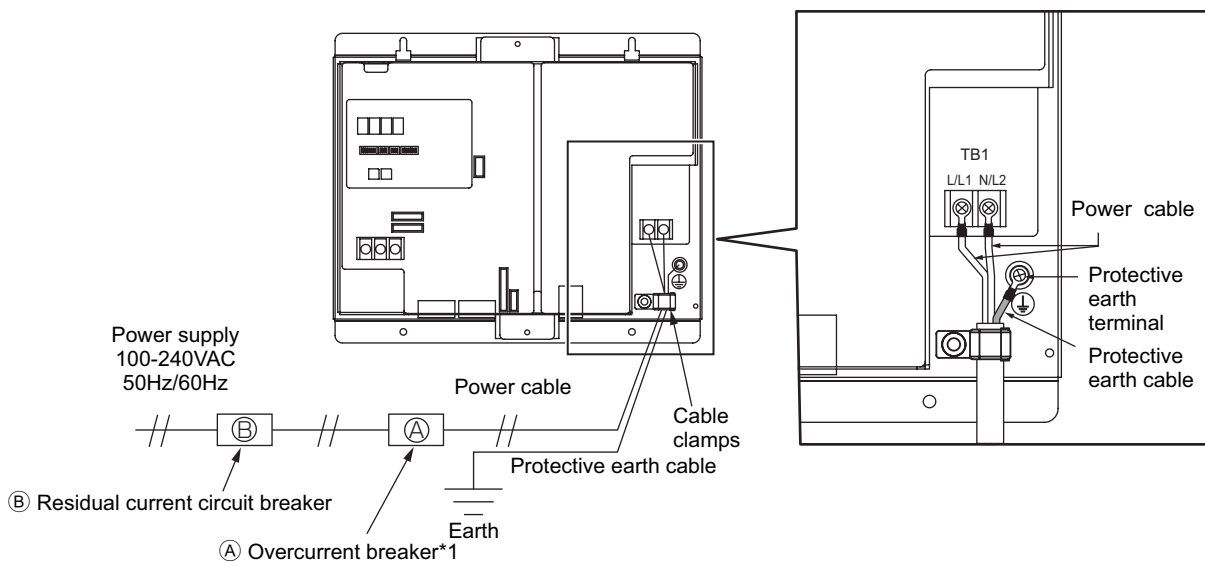

\*1 When using a fuse, use it in combination with a main switch (Rated current: 3A).



### 6-3. Connecting the M-NET transmission line

**CAUTION** • In an air conditioner system has more than 1 Outdoor units, System controller receiving transmission power through TB7 on one of the Outdoor unit would have a risk that the connected Outdoor units failure would stop power supply to System controller, and disrupt the whole system.

**(1) To supply power to the M-NET transmission line from GB-50ADA**  
Connect the M-NET transmission lines as shown in the figure below.

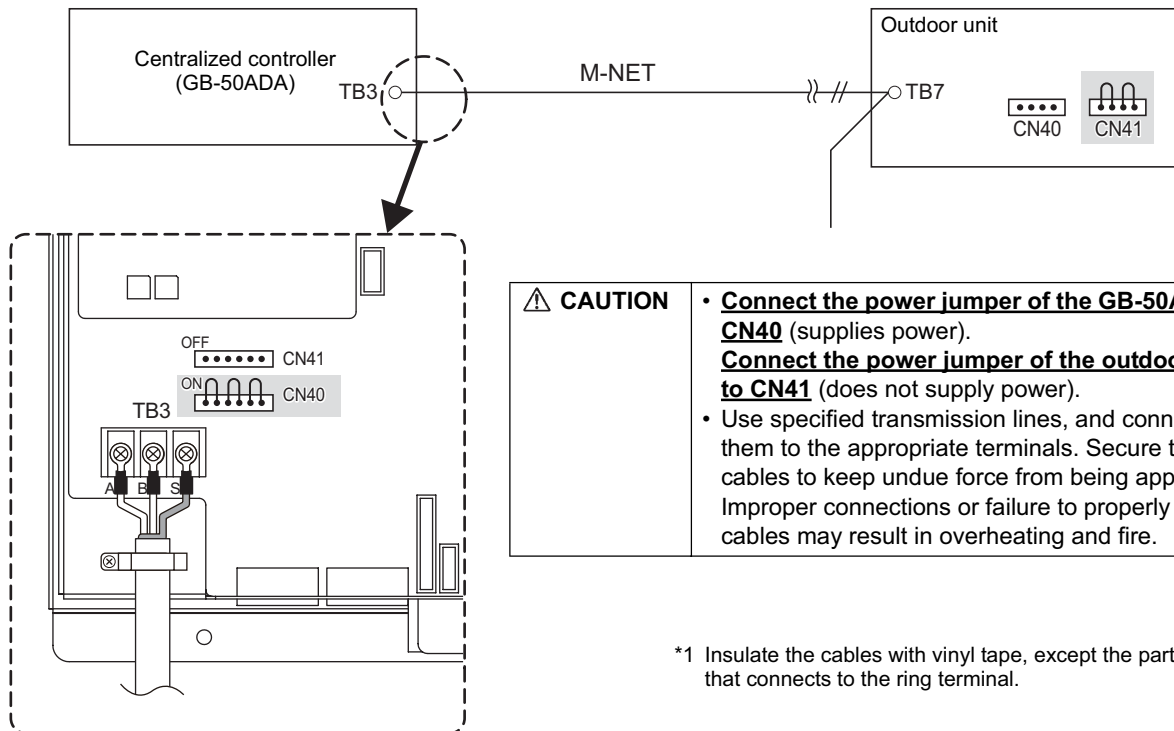

**CAUTION** • **Connect the power jumper of the GB-50ADA to CN40** (supplies power).  
**Connect the power jumper of the outdoor unit to CN41** (does not supply power).  
• Use specified transmission lines, and connect them to the appropriate terminals. Secure the cables to keep undue force from being applied. Improper connections or failure to properly secure cables may result in overheating and fire.

\*1 Insulate the cables with vinyl tape, except the part that connects to the ring terminal.

**(2) To supply power to the M-NET transmission line from the power supply unit (PAC-SC51KUA, etc.)**  
Connect the M-NET transmission lines as shown in the figure below.

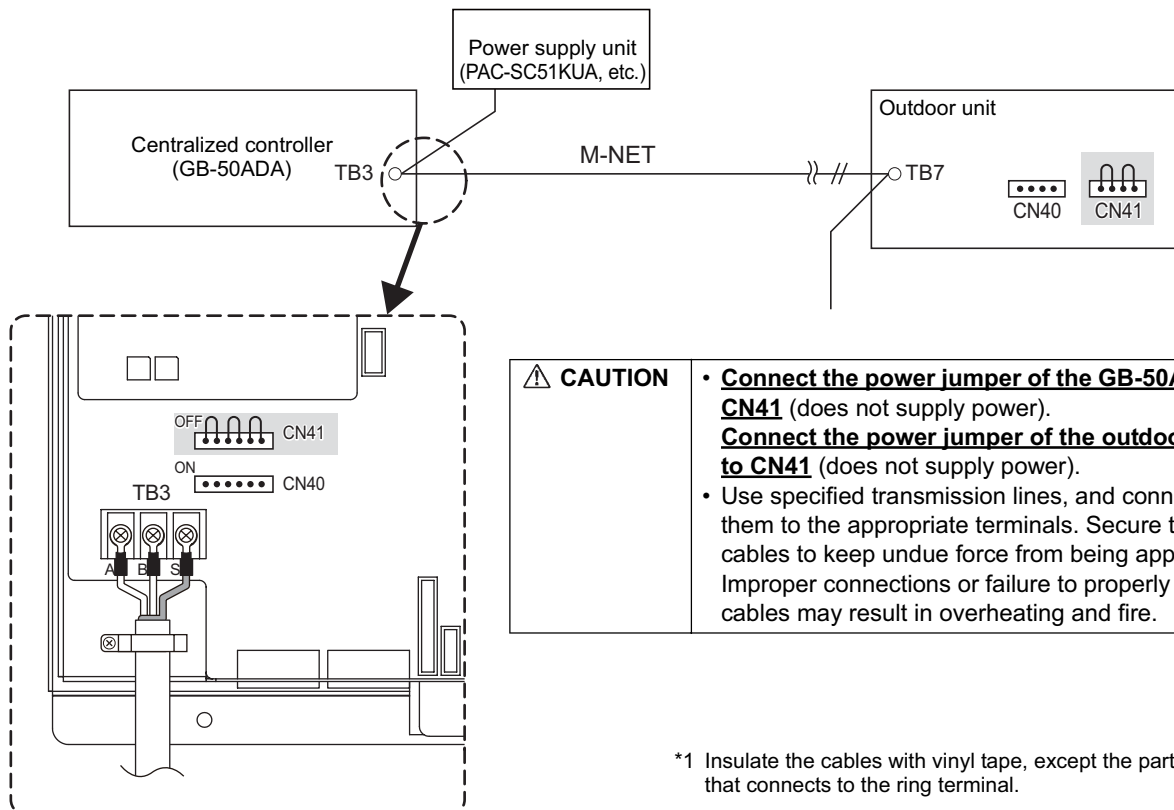

**CAUTION** • **Connect the power jumper of the GB-50ADA to CN41** (does not supply power).  
**Connect the power jumper of the outdoor unit to CN41** (does not supply power).  
• Use specified transmission lines, and connect them to the appropriate terminals. Secure the cables to keep undue force from being applied. Improper connections or failure to properly secure cables may result in overheating and fire.

\*1 Insulate the cables with vinyl tape, except the part that connects to the ring terminal.

#### 6-4. Connecting the LAN cable

Connect the LAN cable to the LAN connector on the GB-50ADA.

- The maximum distance between the HUB and GB-50ADA is 100 m (328 ft).
- The LAN cable is field-supplied. Use a category 5 or above cable (straight cable).
- Use the switching HUB.

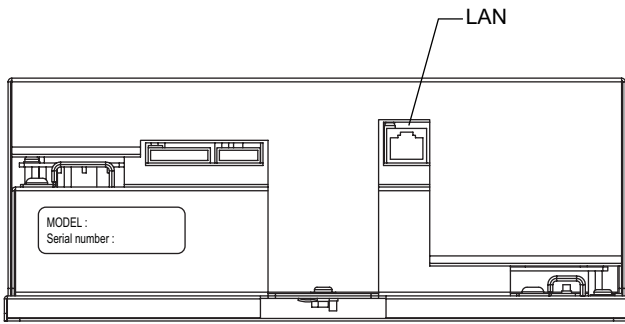

#### **CAUTION**

- Install the LAN cable before installing the unit, and route the cable in the same way as the M-NET transmission lines.
- Leave enough space around the LAN port on the GB-50ADA to allow for the connection of the connector and the cables. Refer to section (5 | Installation).

# 7 Initial settings

## Initial setting procedures

Steps	Setting items	setting <span style="float: right;">○: Settable</span>	
		Switch on the GB-50ADA	Web browser
1	IP address of the GB-50ADA/Network	○	○
	Default settings: IP address           192.168.1.1 Subnet mask        255.255.255.0 Gateway address   0.0.0.0	Refer to section 7-1 "IP address and network settings."	Refer to section 7-1 "IP address and network settings" and the manual for Initial Settings.
2	License number registration	—	○ Refer to the manual for Initial Settings.
3	M-NET address setting for GB-50ADA Default: 00 Normally requires no setting changes.	—	○ Refer to the manual for Initial Settings.
4	Functions (Operation prohibit range setting, external input mode etc.)	—	○ Refer to the manual for Initial Settings.
5	Group	—	○ Refer to the manual for Initial Settings.
6	Interlocked ventilation	—	○ Refer to the manual for Initial Settings.
7	Clock setting	—	○ Refer to the manual for Initial Settings.
8	Other settings(Schedules etc.)	—	○ Refer to the manual for Initial Settings and for System maintenance engineer.
9	Test run	○ Refer to section 9 "Test run"	○ Refer to the manual for Initial Settings and for System maintenance engineer.

## Internal layout of the GB-50ADA

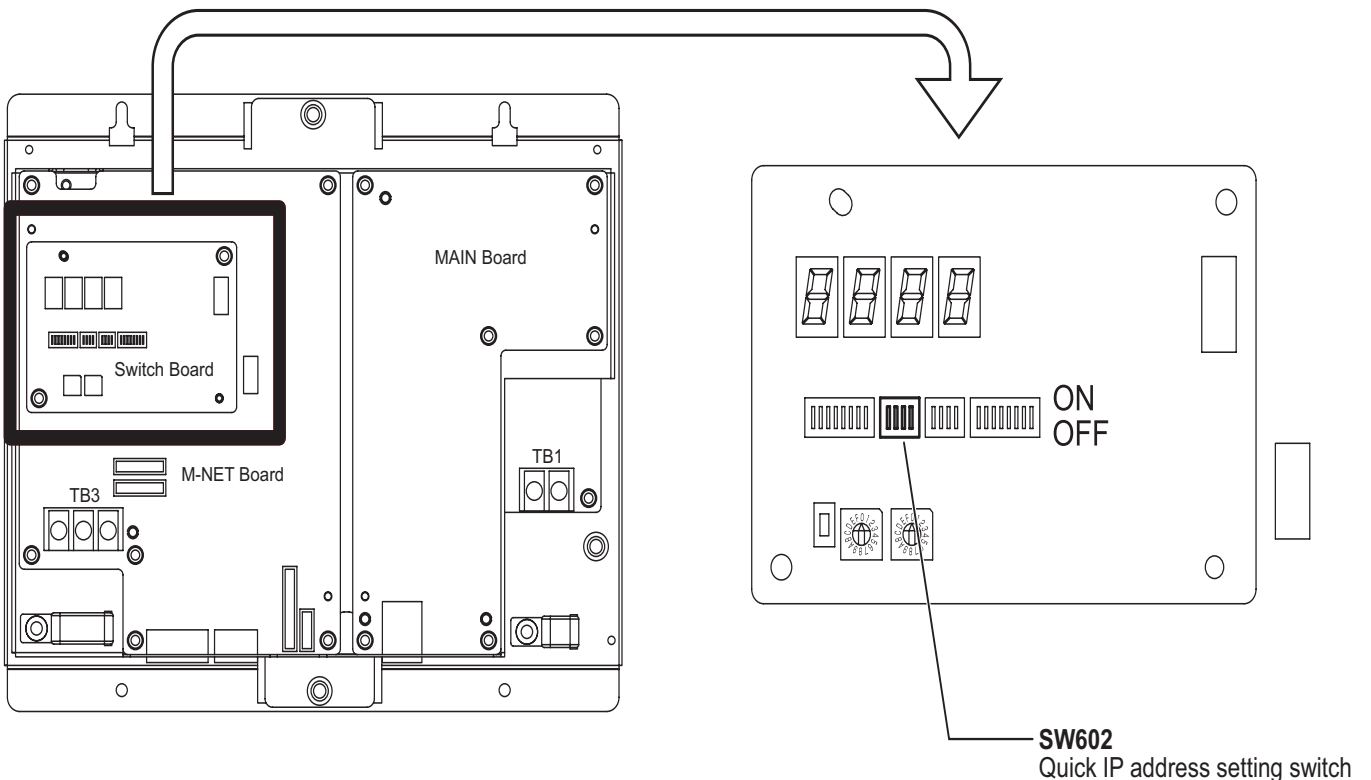

## 7-1. IP address and network settings

When connecting GB-50ADA to a dedicated LAN system, set the IP address and network settings for GB-50ADA with “Quick IP address setting switch.” (Refer to section 7-1-1 “Quick IP address setting switch.”)

When connecting to an existing LAN system or settings cannot be made with Quick IP address setting switch, set them with the detail setting switches. (Refer to section 7-1-2 “Setting the IP address or network settings with the Web browser for Initial Settings.”)

### 7-1-1. Quick IP address setting switch

IP address can be easily set to an address between 192.168.1.1 and 192.168.1.15 with dipswitch SW602. Set this dipswitch before turning on the power.

NO	SW602 [0: OFF, 1: ON]				IP address	Subnet mask	Gateway address
	1	2	3	4			
0	0	0	0	0	Initial settings: 192.168.1.1 Use the Web browser for Initial Settings to set the IP address, subnet mask, and gateway address.	Initial settings: 255.255.255.0	Initial settings: 0.0.0.0
1	0	0	0	1	192.168.1.1	255.255.255.0	0.0.0.0
2	0	0	1	0	192.168.1.2		
3	0	0	1	1	192.168.1.3		
4	0	1	0	0	192.168.1.4		
5	0	1	0	1	192.168.1.5		
6	0	1	1	0	192.168.1.6		
7	0	1	1	1	192.168.1.7		
8	1	0	0	0	192.168.1.8		
9	1	0	0	1	192.168.1.9		
10	1	0	1	0	192.168.1.10		
11	1	0	1	1	192.168.1.11		
12	1	1	0	0	192.168.1.12		
13	1	1	0	1	192.168.1.13		
14	1	1	1	0	192.168.1.14		
15	1	1	1	1	192.168.1.15		

<b>Note</b>	<ul style="list-style-type: none"> <li>● If fifteen or fewer GB-50ADA are connected to a dedicated network, it is recommended that the IP address be set with SW602.</li> <li>● Turn all SW602 to OFF before setting the IP address or network settings with the Web browser for Initial Settings (refer to section 7-1-2).</li> </ul>
-------------	--

### 7-1-2. Setting the IP address or network settings with the Web browser for Initial Settings

IP address, subnet mask, or gateway address can be set with Web browser for Initial Settings. Quick IP address setting switches (SW602) should be set to “ALL OFF” to make these settings.

Consult the network administrator for how to set the IP address, subnet mask, and gateway address when connecting GB-50ADA to an existing LAN.

Refer to the manual for Initial settings for how to set.

## 8 Product features

GB-50ADA is a centralized controller that can be operated over the Web. Any connected air conditioning systems can be operated or monitored over the Web using browser software. Refer to the Web browser operation manual (separate volume) for how to use this functions.

Function		Description	
Number of controlled unit	Indoor unit, independent OA processing unit or LOSSNAY	Up to 50 units are connectable (including the interlocked units) *2	
	Number of units in one group (indoor, independent OA processing unit, or LOSSNAY)	1-16 units (Indoor unit, independent OA processing unit and ventilation system (LOSSNAY) cannot be registered to the same group.)	
	Number of remote controllers in one group	1-2	
	Number of system controllers in one group	0-4 (including the number of remote controller in one group)	
	Number of interlocked units	<ul style="list-style-type: none"> <li>Number of LOSSNAY units that can be interlocked with an indoor unit: 1</li> <li>Number of indoor units that can be interlocked with a LOSSNAY unit: 16</li> </ul>	
User Operations Function	Operation *1	ON/OFF	The ON/OFF operation can be performed as a collective, per group, or per block.
		Operation mode	<p>The switch operation for the operation mode setting can be performed as a collective, per group, or per block. (Available modes depend on the model of indoor units.)</p> <p>[Selectable operation mode for the indoor unit] COOL/DRY/FAN/AUTO/HEAT</p> <p>[Selectable operation mode for the independent ventilation] HEAT RECOVERY/BY-PASS/AUTO</p> <p>[Selectable operation mode for PWFY] HEATING/HEATING ECO/HOT WATER/ANTI-FREEZE/COOLING</p>
		Fan speed	Up to four fan speeds are available. Fan speed can be changed collectively, or for each group or block of indoor units. The number of available fan speeds depends on the indoor model (2 speeds, 3 speeds, 4 speeds, and Auto). "Auto" is available only on the models that support that function.)
		Temperature setting	<p>Temperature setting can be performed collectively, per group, or per block.</p> <p>[Setting temperature range for air conditioner] Cool (Dry) operation: 19 ~ 30°C / 67 ~ 87°F Heat operation: 17 ~ 28°C / 63 ~ 83°F Auto operation: 19 ~ 28°C / 67 ~ 83°F</p> <p>[Setting temperature range for PWFY] [Booster unit]*3 [Water HEX unit]*3 Heating: 30 ~ 50°C/87 ~ 122°F Heating: 30 ~ 45°C/87 ~ 113°F Heating: ECO 30 ~ 45°C/87 ~ 113°F Heating ECO: 30 ~ 45°C/87 ~ 113°F Hot Water: 30 ~ 70°C/87 ~ 158°F Hot Water: Invalid Anti-freeze: 10 ~ 45°C/50 ~ 113°F Anti-freeze: 10 ~ 45°C/50 ~ 113°F Cooling: Invalid Cooling: 10 ~ 30°C/50 ~ 87°F</p>
		Air direction and swing operation	Vertical air flow directions (5 directions), auto setting, and swing setting can be changed collectively, or for each group or block of indoor units. (Available air flow directions depend on the model. [5 air flow directions and AUTO] are available only on the models that support those settings.
		Operating/stopping interlocked LOSSNAY units	Interlocked LOSSNAY units (if any) can be operated (at High or Low) or stopped collectively or for each group or block of indoor units. (Ventilation mode cannot be selected for the interlocked LOSSNAY units.)
		Schedule	<p>Group is the smallest unit to which a weekly schedule can be assigned. The same schedule can be applied to each group, groups in a block, or groups on a floor.</p> <ul style="list-style-type: none"> <li>Up to 24 events can be scheduled for each day.</li> <li>"Temperature Setting", "Fan Speed Setting", "Vane Setting", and "Setback Operation" can be timer-controlled.</li> </ul> <p>If a license is registered</p> <ul style="list-style-type: none"> <li>Two types of weekly schedule patterns (summer and winter) are available.</li> <li>Five operation patterns can be set for each year, up to 50 days can be allocated to each pattern.</li> </ul>

		Function	Description
User Operations Function	Operation *1	Prohibit local remote control	Operation of certain functions from the local remote controllers can be prohibited collectively or for each group or blocks of indoor units. (Applicable functions: ON/OFF, operation mode, temperature setting, filter sign)
		Filter sign reset	Filter sign can be reset for each group or block of indoor units.
		Error reset	Resets the display of error.
		Error history reset	Resets the error history (unit error, communication error).
		External input	Connects to an external input/output device that stops the units in an emergency, run or stop the units, permit or prohibit the operation of units collectively. Requires an external input/output adapter (sold separately) and external power supply (12VDC or 24VDC).
	Monitor *1	Operation status of each group in the system	Operation status (ON/OFF), operation mode, fan speed, temperature setting, air flow direction, operation status (ON/OFF) of interlocked units, timer enable/disable status of each group is displayed.
		Filter sign	Indicates that the filters on the units in a given group is due for cleaning.
		Local operation prohibition	Displays the functions that the controller forbids or the functions that are forbidden by other controllers.
		Error	The address of the unit in error, error code, and the address of the unit that detected the error will appear.
		External output	Outputs signals (run/stop, error) to an external device. Requires an external input/output adapter (sold separately) and external power supply (12VDC or 24VDC).
Initial Settings	Operation *1	Date and time	This function is used to set the current date/time and daylight savings time.
		License	This function is used to register license.
		Unit Info.	This function is used to set unit name, ID number, date format, time format, temperature unit.
		Network	This function is used to set the IP address, subnet mask address, and gateway settings for the LAN and also to set the address for the M-NET, K-transmission converter address, local control prohibit settings, and external input settings.
		Advanced settings	Allows the Master/Sub clock setting to be made.
		Groups	This function is used to register indoor units, LOSSNAY units, remote controllers, and sub system controllers to a group.
		Blocks	This function is used to register a group to a block.
		Interlock	This function is used to interlock the operation of indoor units and ventilation units.
	Monitor *1	Error history monitor	Up to 128 errors can be stored in memory. (64 unit errors, 64 communication errors)
Function	Operation *1	External temperature interlock	Control level of outside temperature interlock function can be set for each group.
		Night setback control	Control time and upper/lower limit temperature can be set for setback function.
		Interlock control	Interlock control can be performed between the connected devices by making interlock settings (up to 150 settings).
User Setting	Operation *1	Maintenance User	Allows the maintenance user name and password to be set.
		Building Manager	Allows the building manager name, password, function enable/disable settings to be made.
Other	Data back-up	Connection/Interlock Information	Group setting information and interlock setting information are retained, even if power is turned off.
		Error history	Retained, even if power is turned off.
		Schedule data	Schedule information of each group is retained, even if power is turned off.
		Current time	Current time is retained by the build-in capacitor for a week, even if power is turned off.
		Saving the data on a USB drive	The initial setting data, operational data (charge parameter, power consumption) can be stored to a USB drive.
		Reading data from USB memory	Initial setting data can be read from USB memory.
	Device maintenance	Time synchronization	Clocks on the controllers and units that are under the control of the main controller are synchronized once a day (applicable only to the ones that support this function).

\*1: The item and range that can be operated or monitored depend on the function of the indoor unit.

\*2: The maximum number of the controllable units varies, depending on the indoor unit.

\*3: "Air To Water" on the GB-50ADA's web screen indicates Booster unit group and Water HEX unit group.

## 9 Test run

### 9-1. Batch operation/Stop (error reset) switches

- Before performing a test run, check that the group setting and interlock settings have been properly made.
- The batch operation function on the GB-50ADA switches cannot be used to change the operation mode of the connected indoor units (including the test run mode). Units will be operated in the mode they are set to operate in. The GB-50ADA switches does not have the function to automatically stop the test run in two hours as the remote controllers do.

#### <Setting procedures>

- ① Turn on all units and the GB-50ADA.
- ② Set the switches as follows. SW601: All set to OFF; SW606: "0"; SW607: "0"
- ③ Check that LD5 on the GB-50ADA is unlit (SW601: All set to OFF; SW606: "0"; SW607 "0").  
LD5 will be lit if the group setting and interlock setting have not been completed.  
LD5 will blink while M-NET is starting up (takes approx. 10 minutes to complete).
- ④ Turn SW603-1 from the OFF position to the ON position. The operation signal will be sent to the groups that are registered.\*1
- ⑤ LD3 (SW601: All set to OFF; SW606: "0"; SW607 "0") will be lit when the units are in operation.
- ⑥ Check each unit for proper operation (e.g., supply air comes out of the indoor unit outlet.).
- ⑦ Turn SW603-2 from the OFF position to the ON position to bring the units to stop or to reset the errors.
- ⑧ Turn SW603-1 and SW603-2 to OFF at the completion of the test run.

SW603	Function setting
1	Transmission of operation run signal to the registered groups (when turned ON from the OFF position)*1
2	Transmission of operation stop or error reset signals to the registered groups (when turned ON from the OFF position)*1

\*1 The equipment connected to DIDO controller cannot be operated.

### 9-2. Service LED display

GB-50ADA has service LEDs to display the operation status.

LED No.	Item	Status	Notes	
LAN	LAN LINK ACT	Lit	Linking	
		Unlit	Not linked	
		Blink	Transmitting	
M-NET	M-NET	Lit	Powered	
		Unlit	Not powered	
		Blink	M-NET transmission in progress	
Error	Error status	Blink	At least one air conditioning unit is in error	
		Unlit	Normal	
7-segment LED	LD1	CPU status	Lit	Normal
			Unlit	Error
	LD2	(Not assigned)	—	
	LD3	Operation status	Lit	At least one air conditioning unit is in operation.
			Unlit	All units are stopped.
	LD4	Error status	Lit	At least one air conditioning unit is in error
			Unlit	All units are normal.
	LD5	M-NET startup status	Lit	Group information not available
			Unlit	Complete
			Blink	Starting up
LD6	(Not assigned)	—		
LD7	(Not assigned)	—		
LD8	(Not assigned)	—		

SW601: All set to off  
SW606: [0]  
SW607: [0]

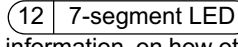
(Refer to  for information on how other settings are displayed.)

7-segment LED

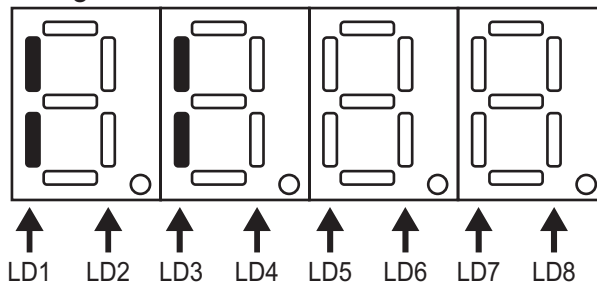

# 10 External input/output

## 10-1. External signal input function

\* To use the external signal input, a separately-sold external input/output adapter (PAC-YG10HA) and external power supply are required.

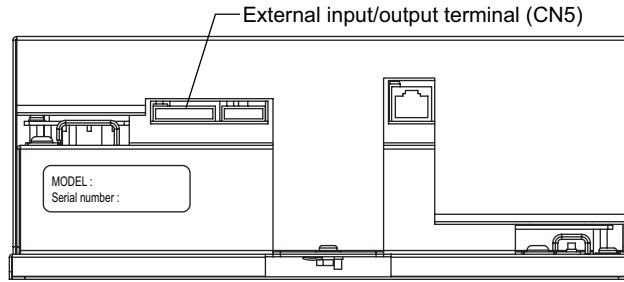

### 10-1-1. External input signal function setting (to be set from the web browser for Initial settings)

External contact signal (12VDC or 24VDC) can be used to send signals indicating the following status of all air conditioning units that are controlled by the controller: Emergency stop/Normal, Run/Stop, and local remote controller operation Prohibit/Permit.

No.	External input signal function	Notes
1	External input signal will not be used. (factory setting)	—
2	Emergency stop/Normal (level signal)	During the emergency stop, the Run/Stop mode cannot be changed from the local remote controller, and the Run/Stop mode and Prohibit/Permit settings cannot be changed from the GB-50ADA. Timer setting will be ignored.
3	Run/Stop (level signal)	The Run/Stop mode cannot be changed from the local remote controller, and the Run/Stop mode and Prohibit/Permit settings cannot be changed from the GB-50ADA. Timer setting will be ignored.
4	Run/Stop, Prohibit/Permit (pulse signal)	The pulse width (contact ON) should be between 0.5 and 1 second.

\* DIDO controller (PAC-YG66DCA) cannot be collectively run or stopped by using the external input function. But when [Emergency stop/Normal (Level signal)] is selected, DIDO controller (PAC-YG66DCA) can be collectively stopped by setting the appropriate switches on the DIDO controller.

### 10-1-2. Level signals and pulse signals

#### (A) Level signals

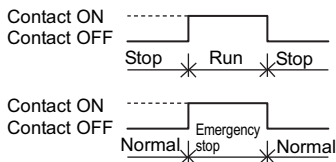

#### (B) Pulse signal

(Example) Run/Stop

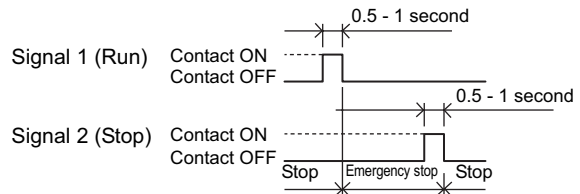

\* Same with the Prohibit/Permit signal input.

### 10-1-3. External input specifications

CN5	Lead wire (PAC-YG10HA)	Emergency stop/Normal (level signal)	Run/Stop (level signal)	Run/Stop, Prohibit/Permit (pulse signal)
No. 5	Orange	Emergency stop/Normal signal input	Run/Stop signal input	Operation signal input
No. 6	Yellow	Not used	Not used	Stop signal input
No. 7	Blue	Not used	Not used	Local remote controller operation prohibit signal input
No. 8	Gray	Not used	Not used	Local remote controller operation permit signal input
No. 9	Red	External power supply 12VDC or 24VDC		

#### (A) Level signals

- ① If "Emergency stop/Normal operation signal" is selected, the unit will come to an emergency stop when the contact turns on, and the unit will resume normal operation when the contact turns off. When emergency stop is reset, all units will remain stopped, including the ones that were operating before the emergency stop signal input was received. To return to the previous operation status, these units need to be manually restarted.
- ② If "Run/Stop signal input" is selected, the unit will go into operation when external input signal contact turns ON, and the unit will stop when the contact signal turns OFF.



**(B) Pulse signals**

- ① If pulse signals to operate the units are received while the units are in operation, the units will continue their operation (same with the Stop, Prohibit, and Permit signals).
- ② When operation from the local remote controllers is prohibited, Run/Stop mode, operation mode, temperature setting, and filter reset settings cannot be changed from the local remote controller.
- ③ The pulse width (contact ON) should be between 0.5 and 1 second.

**10-1-4. Recommended circuit**

**(A) Level signals**

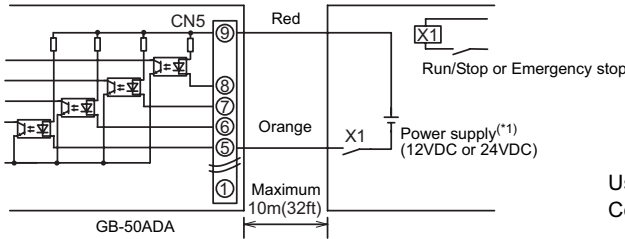

Use relays that meet the following specifications for X1, X2, Y1, and Y2.

Contact rating  
 Rated voltage: 12VDC or above  
 Rated current: 0.1 A or above

Minimum applied load: DC 1 mA or below

(\*1) Use a power supply suitable for the type of relays used.  
 (12VDC or 24VDC)

**(B) Pulse signals**

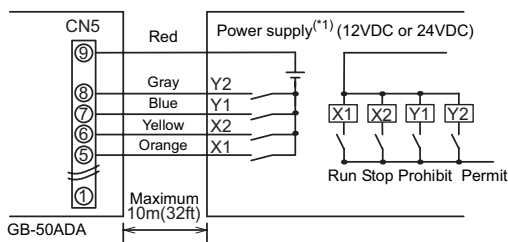

- ① Relays, DC power supplies, and extension cables are field supplied.
- ② The maximum length of extension cable is 10 m (32 ft). (Use a cable with a diameter of at least 0.3 mm<sup>2</sup>.)
- ③ Cut the excess cable near the connector, and insulate the exposed cable end with tape.

**10-2. External signal output function**

\* A separately sold external input/output adapter (PAC-YG10HA) and external power supply are required to use the external signal output.

**10-2-1. External output**

Operation signal is output when one or more units are in operation, and error signal is output when one or more units are in error.

**10-2-2. External output specification**

CN5	Lead wire (PAC-YG10HA)	Terminal type
No. 1	Green	Common GND for external output (external DC, power supply GND)
No. 2	Black	Run/Stop*
No. 3	Brown	Error/Normal

\* The operation status of DIDO controller is not output.

\* Operation signal is output during an error.

**10-2-3. Recommended circuit**

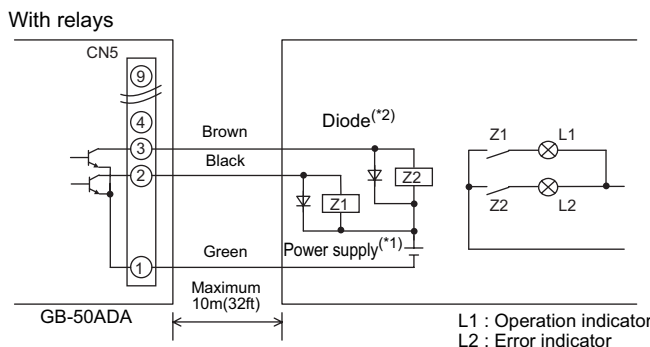

Use relays that meet the following specifications for Z1 and Z2.

Operation coil  
 Rated voltage: 12VDC or 24VDC  
 Power consumption: 0.9 W or less

(\*1) Use a power supply suitable for the type of relays used.  
 (12VDC or 24VDC)

(\*2) Use a diode at both ends of the relay coils.

- ① Each element turns on during operation and error.
- ② The maximum length of extension cable is 10 m (32 ft).
- ③ Relays, lamps, diodes, and extension cables are field supplied.

# 11 Copy to USB memory and read from USB memory

To copy the data to USB memory and to read the data from USB memory, refer to the table below and section 11-1 "switch setting".

Item No.	SW601 [0: OFF, 1: ON]								Setting items	Explanation	Notes
	1	2	3	4	5	6	7	8			
250									Copy to USB memory		
									(0) Initial setting data and User info data	Set to SW606: "0"; SW607: "0" Copy the Initial setting data and the User info data to the \["GB_" + Serial Number] folder in the root folder of the USB memory.	Initial setting data and User info data
									(1) Initial setting data	Set to SW606: "0"; SW607: "1" Copy the Initial setting data to the \["GB_" + Serial Number] folder in the root folder of the USB memory.	
	1	1	1	1	1	0	1	0	(8) User info data	Set to SW606: "0"; SW607: "8" Copy the user info data to the \["GB_" + Serial Number] folder in the root folder of the USB memory.	
									(9) Charge parameter data	Set to SW606: "0"; SW607: "9" Copy the Charge parameter data to the \["GB_" + Serial Number]\ChargeParameters\[Date] folder in the root folder of the USB memory in the CSV format. Refer to section 11-2-1 "Charge parameter data".	Saving the Charge parameter data and Power consumption data may take several dozens of minutes.
									(10) Power consumption data	Set to SW606: "0"; SW607: "A" Copy the Power consumption data to the \["GB_" + Serial Number]\ChargeParameters\[Date] folder in the root folder of the USB memory in the CSV format. Refer to section 11-2-2 "Power consumption data"	
251	1	1	1	1	1	0	1	1	Read from USB memory  Initial setting data and User info data	Set to SW606: "0"; SW607: "0" Read the data from USB memory. Create ["SetupData_" + IP address]*1 or ["SetupData"] folder in the root folder of the USB memory using PC.*2 Save the setting data*3 in the folder. *1: When the IP address of GB-50ADA is "192.168.1.1", the folder name will be [SetupData_192_168_1_1]. *2: If both ["SetupData_" + IP address] folder and ["SetupData"] folder exist, the data from ["SetupData_" + IP address] folder will be read. *3: "(0) Initial setting data and User info data" or "(1) Initial setting data" or "(8) User info data"	Reset the power after all settings have been made.

<b>Note</b>	<ul style="list-style-type: none"> <li>Use a USB memory that supports USB 1.1 standards. Some security-enhanced USB memories cannot be used. The following USB memories are checked for proper operation. (As of Oct. 2009)</li> </ul> <table border="0"> <tr> <td>a: Manufacturer: Sandisk</td> <td>Model: SDCZ6-2048-J65RB</td> <td>Capacity: 2G</td> <td></td> </tr> <tr> <td>b: Manufacturer: Kingston</td> <td>Model: DT400/2GBFE</td> <td>Capacity: 2G</td> <td></td> </tr> <tr> <td>c: Manufacturer: I-O DATA</td> <td>Model: TB-BH2/2G/*</td> <td>Capacity: 2G</td> <td></td> </tr> <tr> <td>d: Manufacturer: I-O DATA</td> <td>Model: TB-BH2/4G/*</td> <td>Capacity: 4G</td> <td></td> </tr> <tr> <td>e: Manufacturer: BUFFALO</td> <td>Model: RUF-C2GS-*/U2</td> <td>Capacity: 2G</td> <td rowspan="6">* Use FAT32 or FAT16 to format a USB memory if necessary.</td> </tr> <tr> <td>f: Manufacturer: BUFFALO</td> <td>Model: RUF2-C2GS-*/M</td> <td>Capacity: 2G</td> </tr> <tr> <td>g: Manufacturer: BUFFALO</td> <td>Model: RUF-C4GS-*/U2</td> <td>Capacity: 4G</td> </tr> <tr> <td>h: Manufacturer: BUFFALO</td> <td>Model: RUF-C8GS-*/U2</td> <td>Capacity: 8G</td> </tr> <tr> <td>i: Manufacturer: adata</td> <td>Model: C702</td> <td>Capacity: 2G</td> </tr> <tr> <td colspan="3">(* or ** in the models of c through h indicates color. )</td> </tr> </table>	a: Manufacturer: Sandisk	Model: SDCZ6-2048-J65RB	Capacity: 2G		b: Manufacturer: Kingston	Model: DT400/2GBFE	Capacity: 2G		c: Manufacturer: I-O DATA	Model: TB-BH2/2G/*	Capacity: 2G		d: Manufacturer: I-O DATA	Model: TB-BH2/4G/*	Capacity: 4G		e: Manufacturer: BUFFALO	Model: RUF-C2GS-*/U2	Capacity: 2G	* Use FAT32 or FAT16 to format a USB memory if necessary.	f: Manufacturer: BUFFALO	Model: RUF2-C2GS-*/M	Capacity: 2G	g: Manufacturer: BUFFALO	Model: RUF-C4GS-*/U2	Capacity: 4G	h: Manufacturer: BUFFALO	Model: RUF-C8GS-*/U2	Capacity: 8G	i: Manufacturer: adata	Model: C702	Capacity: 2G	(* or ** in the models of c through h indicates color. )		
a: Manufacturer: Sandisk	Model: SDCZ6-2048-J65RB	Capacity: 2G																																		
b: Manufacturer: Kingston	Model: DT400/2GBFE	Capacity: 2G																																		
c: Manufacturer: I-O DATA	Model: TB-BH2/2G/*	Capacity: 2G																																		
d: Manufacturer: I-O DATA	Model: TB-BH2/4G/*	Capacity: 4G																																		
e: Manufacturer: BUFFALO	Model: RUF-C2GS-*/U2	Capacity: 2G	* Use FAT32 or FAT16 to format a USB memory if necessary.																																	
f: Manufacturer: BUFFALO	Model: RUF2-C2GS-*/M	Capacity: 2G																																		
g: Manufacturer: BUFFALO	Model: RUF-C4GS-*/U2	Capacity: 4G																																		
h: Manufacturer: BUFFALO	Model: RUF-C8GS-*/U2	Capacity: 8G																																		
i: Manufacturer: adata	Model: C702	Capacity: 2G																																		
(* or ** in the models of c through h indicates color. )																																				

### 11-1. Switch setting

How to set the switches is explained below, using an example of how to set the item No. 250 "(0) Initial setting data and User info data".

Steps	Setting item	Setting method	7-segment LED display
1	Select the item No.	Set SW601 to [1111 1010].	[ _ 250 ] will appear for one second, and the SW606 and SW607 preset values will appear.
2	Enter a value.	Set SW606 (upper digit) to "0", and SW607 (lower digit) to "0".	[ 0 ]
3	Save the setting.	Press and hold SW605 for three seconds.	[ End ] will appears after [ 0 ] blinks. Reset the setting when [ Err_ ] is displayed.

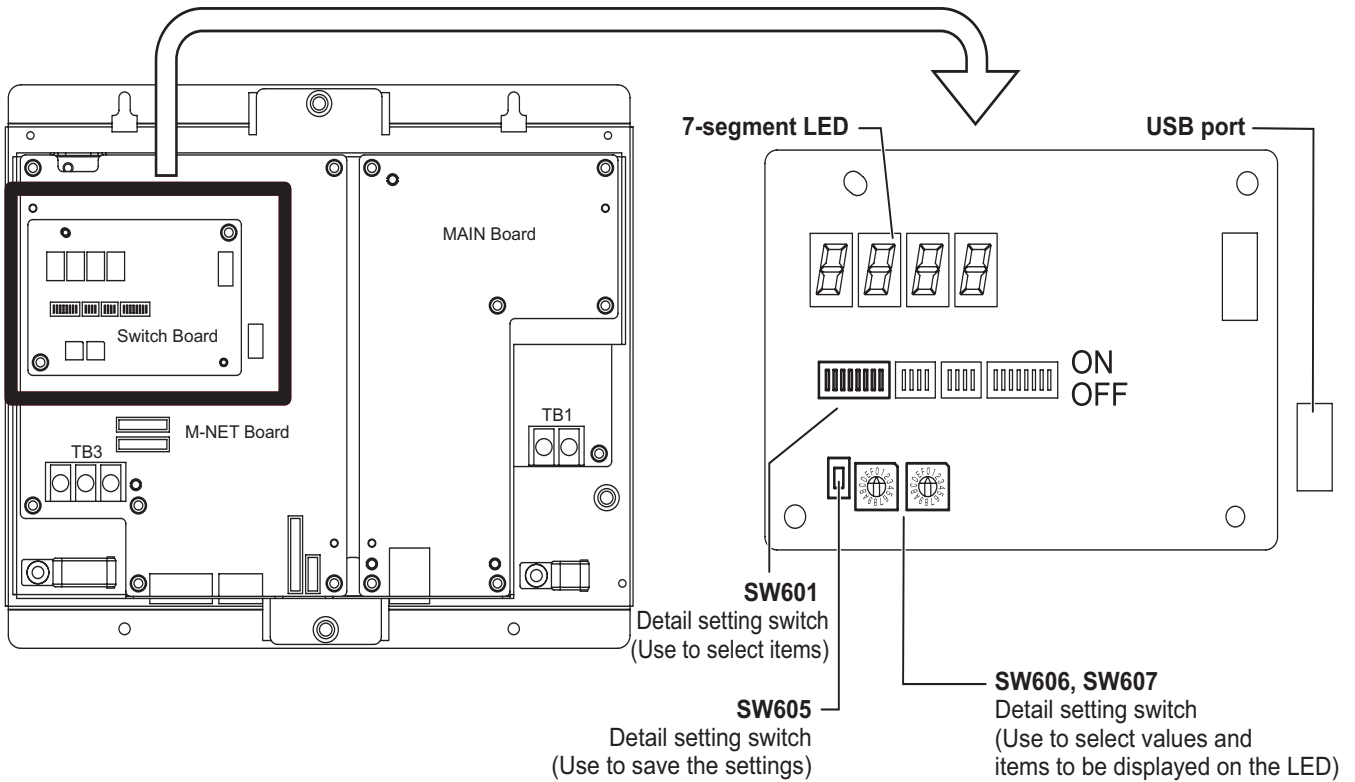

## 11-2. Operational data

### 11-2-1. Charge parameter data

The format of the CSV file that is output when the charge parameter is saved is as follows:

Note: Dates in the folder name, the file name, and the file contents are displayed in the format selected on the Initial Setting Web.

“March 10, 2010” would be expressed  
 as [10/03/2010] in the [dd/mm/yyyy] format,  
 as [03/10/2010] in the [mm/dd/yyyy] format, and  
 as [2010/03/10] in the [yyyy/mm/dd] format.

[File name]

ChargeParameter\_[date]A[Indoor unit address (fixed 2 digits)]-[Time zone (1-5)].csv

Example) ChargeParameter\_10-03-2010A01-1.csv

[File contents]

The format of each CSV file is as follows. Each file contains up to 62 days of data.

\* Delimiter (“,” or “;”) and decimal point (“.” or “.”) that are used by the CSV file are selected on the Initial Setting Web.

	Item	Format
1st line	File class	Charge parameter: 201
2nd line	Data range	Records the range of data read in from non-volatile memory Start date + “-” + End date
3rd line	Target trend	“Address” + M-NET address
4th line	Item	“Date, SaveValue, Thermo Time, FanTime, SubHeaterTime”
5th to 66th line (max.)	Data	date, save value, thermo time, fan time, sub heater time * The value for each data type is a cumulative value since the beginning of operation.

\*Charge parameter data range is 0 through 999999. If the count value exceeds the maximum value, the count value goes back to 0.

\*The file is not output until the operation starts because the data does not exist.

\*When the Energy Management License Pack has not been registered, the file is not output.

Example)

```

201
10/03/2010-12/03/2010
Address 01
Date, SaveValue, Thermo Time, FanTime, SubHeater Time
10/03/2010,57,102,150,0
11/03/2010,76,122,178,0
12/03/2010,84,134,149,0
  
```

### 11-2-2. Power consumption data

The format of the CSV file that is output when the power consumption data is saved is as follows:

Note: Dates in the folder name, the file name, and the file contents are displayed in the format selected on the Initial Setting Web.

“March 10, 2010” would be expressed  
 as [10/03/2010] in the [dd/mm/yyyy] format,  
 as [03/10/2010] in the [mm/dd/yyyy] format, and  
 as [2010/03/10] in the [yyyy/mm/dd] format.

[File name]

ChargeParameter\_[date]MCPA[ PI controller (PAC-YG60MCA) address (fixed 2 digits)]-[Time zone (1-5)].csv

Example) ChargeParameter\_10-03-2010MCPA50-3.csv

[File contents]

The format of each CSV file is as follows. Each file contains up to 62 days of data.

\* Delimiter (“,” or “;”) and decimal point (“.” or “.”) that are used by the CSV file are selected on the Initial Setting Web.

Item	Format
1st line	File class Power consumption: 202
2nd line	Data range Records the range of data read in from non-volatile memory Start date + “-” + End date
3rd line	Target trend “MCP”+[ PI controller address]-[Time zone]
4th line	Item “No., Date, Count value(Ch1), Count value(Ch2), Count value(Ch3) , Count value(Ch4)”
5th to 66th line (max.)	Data no., date, count value(Ch1), count value(Ch2), count value(Ch3) , count value(Ch4) * The value for each data type is a cumulative value since the beginning of operation.

\*No. is consisted of three-digit number: address (two digits) and Time zone (one digit).

\*Power consumption data range is 0.00 through 999999.99. If the count value exceeds the maximum value, the count value goes back to 0.00.

\*The file is not output until the operation starts because the data does not exist.

\*When the Energy Management License Pack has not been registered, the file is not output.

Example)

```

202
10/03/2010-12/03/2010
MCP 50-3
No., Date,Count value(Ch1), Count value(Ch2), Count value(Ch3) , Count value(Ch4)
503,10/03/2010,100000,0,0,0
503,11/03/2010,100100,0,0,0
503,12/03/2010,100250,0,0,0
    
```

## 12 7-segment LED

The settings for switches SW601, SW606, and SW607 on the GB-50ADA can be verified on the 7-segment LED.

- Numerical display  
(Example: 18.8)

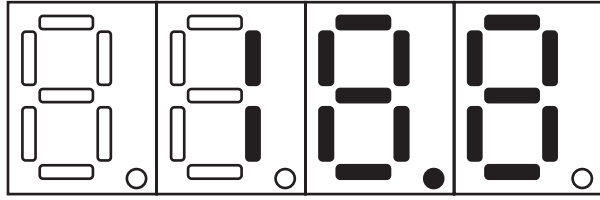

- Flag display  
(Example: LD1, LD2, LD5, and LD7 are on.)

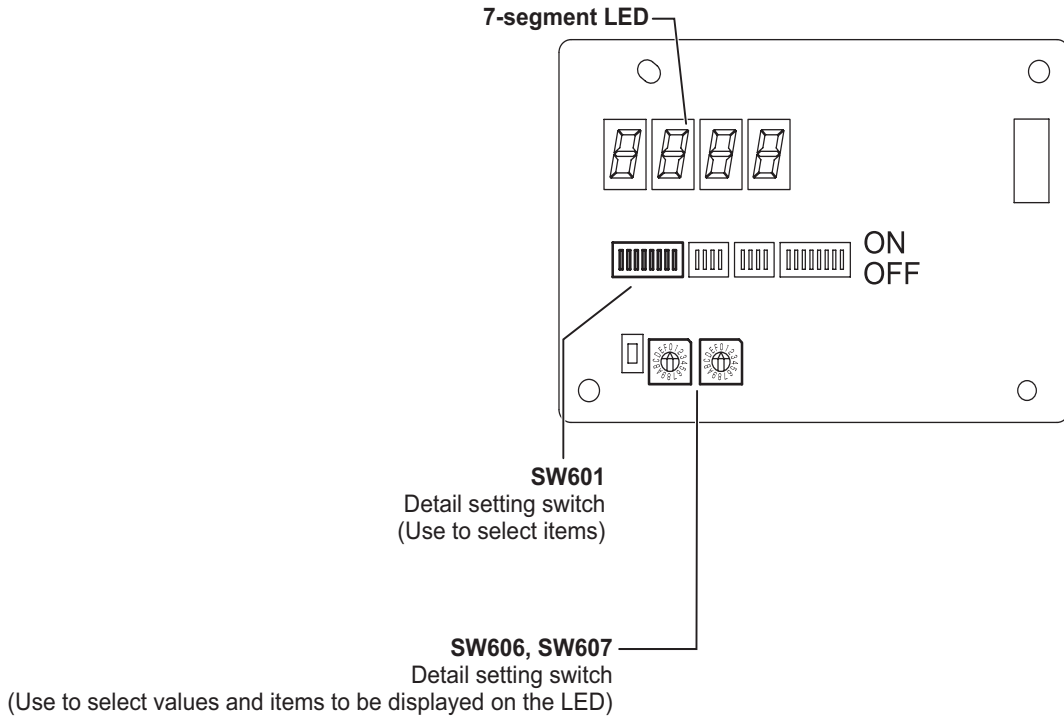
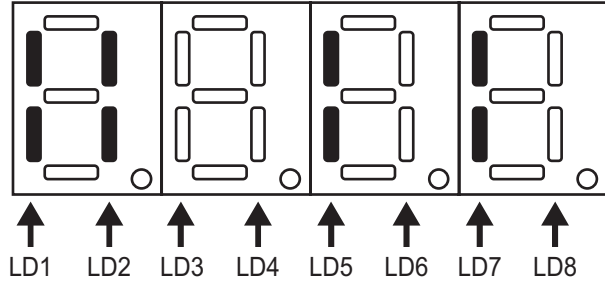

### 12-1. 7-segment LED display and switch settings

SW601 1234 5678	SW606	SW607	Item	Display								Notes	
				LD1	LD2	LD3	LD4	LD5	LD6	LD7	LD8		
0000 0000	0	0	status	CPU status		Normal operation	Error	Starting up				Refer to section 9 "Test run."	
0: OFF 1: ON	0	1	Error detection	[Error code] and [Error source address] appear alternately. The latest error appears if multiple errors have occurred.								[---] appears when there are no errors.	
	1	0	IP address	a	IP address a.b.c.d								
	1	1		b									
	1	2		c									
	1	3		d									
	1	4	Subnet mask	a	Subnet mask a.b.c.d								
	1	5		b									
	1	6		c									
	1	7		d									
	1	8	Gateway	a	Gateway address a.b.c.d								
	1	9		b									
	1	A		c									
	1	B		d									
	1	C	MAC address	a	MAC address a-b-c-d-e-f								
	1	D		b									
	1	E		c									
	1	F		d									
	2	0		e									
	2	1		f									
	2	2	M-NET address	000, 201 ~ 250									
2	3	S/W version	00.00 ~ 99.99										
2	6	Current date	Year	[Year]									
2	7		Month. Date	[Month.Date]									
2	9		Hour: Minute	[Hour: Minute]									
2	A		Second	[Second]									
3	C	Serial number	abc	Serial number abcde-fgh									
3	D		de										
3	E		fgh										

## 13 Error code list

### Notes

- The list below contains all error codes. Some of these error codes may not be applicable to the system to which the GB-50ADA is connected.

The following is a list of the error codes and their meaning. (A) indicates A-control units

0100	"Blanket unit error"
01*0	"Equipment abnormality **"
0403	"Serial transmission trouble"
0404	Indoor unit EEPROM abnormality (A)
0701	Combustion circuit abnormality (A)
0702	Overheat protection for the combustion heat exchanger (A)
0703	Accidental fire (A)
0704	Heater abnormality (A)
0705	Seismoscope malfunction (A)
0706	Flame current sensor abnormality (A)
0707	Ignition problem (A)
0708	Blower motor rotational speed abnormality (A)
0709	Oil pump circuit abnormality (A)
0900	"Test run"
1000	"Ref.cycle abnormality"
10*0	"Ref.cycle abnormality in line **"
1102	Discharge temperature abnormality (TH4) (A)
1108	Inner thermo (49C) trip (A)
11**	"Ref.cycle temperature abnormality - Common operand: **"
12**	"Ref.cycle temperature abnormality allowance - Common operand: **"
1300	Low pressure abnormality (63L trip) (A)
13**	"Ref.cycle pressure abnormality - Common operand: **"
14**	"Ref.cycle pressure abnormality allowance - Common operand: **"
1500	"Ref.cycle not operate due to overcharge"
1501	"Ref.cycle not operate due to undercharge" (/compressor shell temperature abnormality)
1502	"Ref.cycle not operate due to liquid back" /Low pressure abnormality (63L trip) (A)
1503	"Ref.cycle not operate due to coil frost"
1504	"Ref.cycle not operate due to overheat protection"
1505	"Ref.cycle not operate due to compressor vacuum operation protection/refrigerant low temperature abnormality"
1506	"Ref.cycle not operate due to refrigerant pump abnormality"
1507	"Ref.cycle not operate due to composition detection abnormality"
1508	"Ref.cycle not operate due to control valve fault"
1509	"Ref.cycle not operate due to high pressure abnormality (ball valve closed) "
1510	"Ref. cycle gas leakage"
1511	"Ref.cycle not operate due to oil slick abnormality"
1512	"Ref.cycle not operate due to a stop of freezing protection function"
1513	"Ref.cycle brine freezing"
1559	"Oil balance circuit abnormality"
1600	"Ref.cycle - Preliminary overcharge refrigerant trouble"
1601	"Ref.cycle - Preliminary lacked refrigerant trouble"
1605	"Ref.cycle - Preliminary suction operation protection"
1606	"Ref.cycle - Preliminary gas pump abnormality"
1607	"Ref.cycle - Preliminary CS circuit closed detection abnormality"
1608	"Ref.cycle - Preliminary control valve abnormality"
1659	"Ref.cycle - Preliminary oil balance circuit abnormality"
2000	"Water system abnormality" (Pump interlock abnormality)
20*0	"Water system abnormality in line **"
21**	"Water system temperature abnormality - Common operand: **"
22**	"Water system temperature abnormality allowance - Common operand: **"
23**	"Water system pressure abnormality - Common operand: **"
24**	"Water system pressure abnormality allowance - Common operand: **"



2500 "Water system not operate due to water leak"

2501 "Water system not operate due to water supply suspension"

2502 "Water system not operate due to drain pump abnormality"

2503 "Water system not operate due to drain sensor abnormality/float switch function"

2504 "Water system not operate due to liquid level abnormality"

2505 "Water system not operate due to cool water valve abnormality"

2506 "Water system not operate due to warm water valve abnormality"

2507 "Water system not operate due to dew condensation prevention control activated"

2600 "Water system operation restricted due to water leak"

2601 "Water system operation restricted due to water supply suspension/humidifier water supply suspension"

2602 "Water system operation restricted due to drain pump abnormality"

2603 "Water system operation restricted due to drain sensor abnormality"

2604 "Water system operation restricted due to liquid level abnormality"

3152 "Air system operation restricted due to inverter control box inner temperature abnormality"

3182 "Air system operation restricted due to housing inner temperature abnormality"

3252 "Air system operation restricted due to preliminary control box temperature abnormality"

3600 "Air system operation restricted due to filter clogging"

3601 "Air system operation restricted due to filter maintenance"

3602 "Air system operation restricted due to damper position detecting abnormality"

37\*\* "Air system operation humidity abnormality allowance - Common operand: \*\*"

38\*\* "Air system operation humidity abnormality - Common operand: \*\*"

4000 "Electric system abnormality"

40\*0 "Electric system abnormality in line \*\*"

4100 "Electric system not operate due to overcurrent shut-off"

4101 "Electric system not operate due to overcurrent protection"

4102 "Electric system not operate due to open phase" /Open phase (T phase), (A)

4103 "Electric system not operate due to reversed phase/open phase"

4104 "Electric system not operate due to electric leak"

4105 "Electric system not operate due to short circuit"

4106 "Electric system not operate due to self power supply OFF/power failure"

4107 "Electric system not operate due to overlord"

4108 "Electric system not operate due to overlord protection/OCR51C" /Open phase (S phase), Open connector 51CM(A)

4109 "Electric system not operate due to OCR51F"

4110 "Electric system not operate due to high voltage part"

4111 "Electric system not operate due to bus current"

4112 "Electric system not operate due to coil overheat 49°C"

4113 "Electric system not operate due to heater overheat"

4114 "Electric system not operate due to fan controller abnormality"

4115 "Electric system not operate due to power supply synchronism abnormality" /Input circuit (circuit board) defect

4116 "Electric system not operate due to motor abnormality/speed abnormality"

4117 Compressor self-protection function trip (A)

4118 Reversed phase detection circuit (circuit board) problem (A)

4119 More than 2 connectors are open.(A)

4121 "Electric system not operate due to trouble in equipment to which a measure against higher harmonics is taken"

4123 "Electric system not operate due to Inverter output error"

4124 "Electric system not operate due to damper abnormality"

4125 "Electric system - Rush-proof circuit abnormality"

4126 "Electric system - Preliminary overcurrent protection/OCR51C"

4162 "Electric system not operate due to compressor coil temperature abnormality delay"

4163 "Electric system not operate due to preliminary fan controller abnormality"

4165 "Electric system not operate due to preliminary power synchronization error"

4171 "Electric system - Preliminary trouble in equipment to which a measure against higher harmonics is taken"

4200 "Inverter abnormality"

420\* "Inverter abnormality - Inverter No.: \*\*"

4210 "Inverter overcurrent shut-off"

421\* "Inverter overcurrent shut-off - Inverter No.: \*\*"

4220 "Inverter bus voltage insufficiency" / Voltage abnormality (A)

422\* "Inverter bus voltage insufficiency - Inverter No.: \*\*"

4230 "Inverter radiating thermostat abnormality"

423\* "Inverter radiating thermostat abnormality - Inverter No.: \*\*"

4240 "Inverter overcurrent (overload) protection"

424\* "Inverter overcurrent protection - Inverter No.: \*\*"

4250 "Inverter IPM/bus voltage abnormality" /Power module abnormality (A)

425\* "Inverter IPM abnormality \*\*"

4260 "Inverter cooling fan trouble"

426\* "Inverter cooling fan trouble - Inverter No.: \*\*"

4300 "Inverter abnormality allowance"

430\* "Inverter abnormality allowance - Inverter No.: \*\*"

4310 "Inverter overcurrent shut-off allowance"

431\* "Inverter overcurrent shut-off allowance - Inverter No.: \*\*"

4320 "Inverter bus voltage insufficiency allowance"

432\* "Inverter bus voltage insufficiency - Inverter No.: \*\*"

4330 "Inverter radiating thermostat abnormality allowance"

433\* "Inverter radiating thermostat abnormality allowance - Inverter No.: \*\*"

4340 "Inverter overcurrent protection abnormality"

434\* "Inverter overcurrent protection abnormality - Inverter No.: \*\*"

4350 "Inverter IPM abnormality allowance"

435\* "Inverter IPM abnormality allowance \*\*"

4360 "Inverter preliminary cooling fan trouble"

436\* "Inverter preliminary cooling fan trouble - Inverter No.: \*\*"

5000 "Sensor trouble"

50\*0 "Sensor trouble in system \*\*"

51\*\* "Temperature sensor trouble - Sensor No.: \*\*"

5202 Open connector (63L) (A)

52\*\* "Pressure sensor trouble - Sensor No.: \*\*"

5300 Current sensor abnormality (A)

53\*\* "Current sensor trouble - Sensor No.: \*\*"

54\*\* "Humidity sensor trouble - Sensor No.: \*\*"

55\*\* "Gas sensor trouble - Sensor No.: \*\*"

56\*\* "Air speed sensor trouble - Sensor No.: \*\*"

57\*\* "Limit switch trouble - Switch No.: \*\*"

58\*\* "Sensor trouble - Sensor No.: \*\*"

59\*\* "Other sensors trouble - Sensor No.: \*\*"

6000 "System abnormality"

6101 "System not operate due to abnormality - With response frame"

6102 "No answer back"

6200 "Controller H/W abnormality"

6201 "E2PROM abnormality"

6202 "RTC abnormality"

6500 "Communication error"

6600 "Communication error - Address duplicate"

6601 "Communication error - Polarity unsettled"

6602 "Communication error - Transmission processor hardware error"

6603 "Communication error - Transmission line busy"

6604 "Communication error - No ACK (06H) (communication circuit error)"

6605 "Communication error - No response frame"

6606 "Communication error - Transmission processor communication error"

6607 "Communication error - No ACK return"

6608 "Communication error - No return of response frame"

6609 "Communication error"

6610 "Communication error"

6700 "Communication error - K-transmission abnormality"

6701 "Communication error - K-transmission error"

6702 "Communication error - K-address duplicate"

6750 "Communication error - K abnormality code PO"

6751 "K abnormality - Room temperature thermistor abnormality"

6752 "K abnormality - Indoor coil thermistor abnormality, Condensation temperature sensor abnormality"

6753 "K abnormality - Transmit/receive error"

6754 "K abnormality - Drain sensor abnormality, Float switch function"

6755 "K abnormality - Drain pump abnormality"

6756 "K abnormality - Coil frost/overheat protection"

6757 "K abnormality - System error"

6758 "K abnormality - Outdoor unit trouble, Indoor/outdoor communication error"

6761 "K abnormality - Room temperature thermistor abnormality"

6762 "K abnormality - Indoor coil thermistor abnormality, Condensation temperature sensor abnormality"

6763 "K abnormality - Transmit/receive error"

6764 "K abnormality - Drain sensor abnormality"

6765 "K abnormality - Drain pump abnormality"

6766 "K abnormality - Coil frost/overheat protection"

6767 "K abnormality - Outdoor unit trouble - Indoor/outdoor communication error"

6771 "K abnormality - High pressure abnormality, Low pressure abnormality"

6772 "K abnormality - Inner thermostat function, Discharge temperature abnormality, Shell thermostat function, Overcurrent protection"

6773 "K abnormality - Radiator plate thermostat function"

6774 "K abnormality - Outdoor thermistor abnormality"

6775 "K abnormality - Pressure sensor abnormality, Indoor/outdoor communication error"

6776 "K abnormality - Overcurrent shut-off"

6777 "K abnormality - System error"

6778 "K abnormality - Normal"

6779 "K abnormality - Refrigerant overcharge, Abnormal voltage, Abnormal CT sensor"

6800 "Communication error - Other communication errors"

6801 "Communication error - V-control communication error"

6810 "Communication error - UR communication error"

6811 "Communication error - UR communication synchronism not recover"

6812 "Communication error - UR communication hardware error"

6813 "Communication error - UR communication status bit detection error"

6820 "Other communication errors"

6821 "Other communication errors - Transmission line busy"

6822 "Other communication errors - No communication ACK"

6823 "Other communication errors - No response command"

6824 "Other communication errors - Receive data error"

6830 "Communication error - MA communication refrigerant address double setting error"

6831 "Communication error - No MA communication reception error"

6832 "Communication error - MA communication synchronism not recover"

6833 "Communication error - MA communication transmission/reception hardware trouble"

6834 "Communication error - MA communication start bit detection error"

6840 "Communication error - A control no indoor/outdoor communication/reception abnormality"

6841 "Communication error - A control indoor/outdoor communication synchronization recovery abnormal"

6844 "A control indoor/outdoor communication incorrect indoor/outdoor wiring connection, excessive number of indoor units (more than five units)"

6845 "Communication error - A control indoor/outdoor communication incorrect indoor/outdoor wiring connection (telecommunication, disconnection)"

6846 "Communication error - A control indoor/outdoor communication startup time exceeded"

7000 "System abnormality"

7100 "System abnormality - Total capacity error"

7101 "System abnormality - Capacity code error"

7102 "System abnormality - Connecting unit number excess"

7103 "System abnormality - Piping length setting error"

7104 "System abnormality - Floor height setting error"

7105 "System abnormality - Address setting over 254"

7106 "System abnormality - Attribute setting error"

7107 "System abnormality - Distributor setting error"

7108 "System abnormality - Ref. system setting error"

7109 "System abnormality - Connection setting error"

7110 "System abnormality - Ref. system connection/connection data unsettled"

7111 "System abnormality - I/O connection equipment not connected/remote controller sensor abnormality"

7112 "System abnormality - I/O type setting error"

7113 "System abnormality - Equipment unsettled"

7116	"System abnormality - Replace non-wash setting error"
7117	"System abnormality- Model identification setting error"
7130	"System abnormality - Different unit model error"
7131	"System abnormality- Mixed cooling only H/P connection error (Facility PAC)"
7132	"System abnormality - Multiple entries of operation performance (Facility PAC)"
7200	"System abnormality - Numeric values unsettled"
7201	"System abnormality - Numeric values unsettled"
73**	"System abnormality - LON-system equipment abnormality"

**NOTE:**

This equipment has been tested and found to comply with the limits for a Class B digital device, pursuant to Part 15 of the FCC Rules. These limits are designed to provide reasonable protection against harmful interference in a residential installation. This equipment generates, uses and can radiate radio frequency energy and, if not installed and used in accordance with the instructions, may cause harmful interference to radio communications.

However, there is no guarantee that interference will not occur in a particular installation.

If this equipment does cause harmful interference to radio or television reception, which can be determined by turning the equipment off and on, the user is encouraged to try to correct the interference by one or more of the following measures:

- Reorient or relocate the receiving antenna.
- Increase the separation between the equipment and receiver.
- Connect the equipment into an outlet on a circuit different from that to which the receiver is connected.
- Consult the dealer or an experienced radio / TV technician for help.







---

This product is designed and intended for use in the residential,  
commercial and light-industrial environment.

The product at hand is  
based on the following  
EU regulations:

- Low Voltage Directive 2006/95/EC
- Electromagnetic Compatibility Directive,  
2004/108/EC

Please be sure to put the contact address/telephone number on  
this manual before handing it to the customer.

 **MITSUBISHI ELECTRIC CORPORATION**

HEAD OFFICE: TOKYO BLDG. , 2-7-3, MARUNOUCHI, CHIYODA-KU, TOKYO 100-8310, JAPAN

Authorized representative in EU: MITSUBISHI ELECTRIC EUROPE B.V.

HARMAN HOUSE, 1 GEORGE STREET, UXBRIDGE, MIDDLESEX UB8 1QQ, U.K.

WT05866X03  
Printed in Japan