



Air Conditioner System

Expansion Controller PAC-YG50ECA

Installation/Instructions Manual

• Safety notes are marked with **WARNING** or **CAUTION**, depending on the severity of possible consequences that may result when the instructions are not followed exactly as stated.

Proper installation is important for your safety and proper functioning of the units. Thoroughly read the following safety precautions prior to installation.

After reading this manual, pass the manual on to the end user to retain for future reference.



The users should keep this manual for future reference and refer to it as necessary. This manual should be made available to those who repair or relocate the units. Make sure that the manual is passed on to any future air condition system users.

Contents

	Page
<u>Safety Precautions</u>	2
<u>Important</u>	4
1. Specifications.....	5
1-1. Product Specifications.....	5
1-2. External dimensions.....	5
1-3. Supplying power to the M-NET transmission lines.....	6
2. System configuration.....	7
2-1. When connecting multiple AG-150A or other controllers [Ver. 1.30 or later].....	8
2-2. Setting M-NET address for various devices.....	9
3. Installation.....	11
3-1. Field-supplied parts.....	11
3-2. M-NET transmission line length.....	12
3-3. Installation.....	13
4. Wiring connections.....	14
4-1. Installing and uninstalling the cover.....	14
4-2. Connecting the power cable and protective earth cable.....	14
4-3. Connecting the M-NET transmission line.....	15
4-4. Connecting the LAN cable.....	16
4-5. Confirming the LAN transmission delay time.....	16
5. Initial settings.....	18
5-1. IP address and network settings for PAC-YG50ECA.....	20
5-2. Function setting.....	22
6. Test run.....	24
6-1. Batch operation/Stop (error reset) switches.....	24
6-2. Service LED display.....	24
7. M-NET system setting example.....	25
8. External input/output.....	26
8-1. External signal input function.....	26
8-2. External signal output function.....	27
9. Detail setting switch setting method.....	28
9-1. Switch setting.....	29
10. 7-segment LED.....	30
10-1. 7-segment LED display and switch settings.....	31
11. Error code list.....	33
11-1. M-NET error code.....	33
11-2. EC line error code.....	37

Safety Precautions

- Thoroughly read the following safety precautions prior to installation.
- Observe these precautions carefully to ensure safety.

 WARNING	Indicates a risk of death or serious injury.
 CAUTION	Indicates a risk of injury or structural damage.

- After reading this manual, pass the manual on to the end user to retain for future reference.
- The users should keep this manual for future reference and refer to it as necessary. This manual should be made available to those who repair or relocate the units. Make sure that the manual is passed on to any future air condition system users.

Electric work must be performed by an authorized technician.

 WARNING
--

Installation

To reduce the risk of fire and electric shock, do not install the units where they can get wet.	Properly install the unit on a stable, load-bearing surface. Unit installed on an unstable surface may fall and cause injury.
To reduce the risk of electric shock, fire, and malfunction, do not install the unit in a steamy or condensing environments.	Units must be properly installed by your dealer or authorized technician according to the instructions in the Installation Manual. Improper installation may result in electric shock or fire.
Properly dispose of the packing materials. Plastic bags can pose suffocation and choking hazards. Keep out of the reach of children. Tear the plastics bags before disposing of them.	

Wire installation

Properly secure the cables with clamps so that the weight of the cables will not strain the connectors. Improperly connected cables may break, produce heat, and cause smoke or fire.	To reduce the risk of electric leak, overheating, and fire, only use standard cables with the proper current carrying capacity.
Electric work must be performed by an authorized technician according to the local regulations and the instructions detailed in this manual. Always use a dedicated circuit. Capacity shortage to the power supply circuit or improper installation may result in electric shock, smoke, or fire.	Use properly rated breakers (residual current circuit breaker (RCCB), main switch + fuse, circuit breaker). The use of improperly rated breakers may result in malfunctions or fire.
Install all required covers. Infiltration of dust or water may cause electric shock, smoke, or fire.	To reduce the risk of electric shock and malfunctions, keep wire pieces and sheath shavings out of the terminal block.
Take appropriate measures against electrical noise interference when installing the air conditioners in hospitals or radio communication facilities. <ul style="list-style-type: none"> • Inverter, power generators, or radio communication equipment may interfere with the normal operation of the unit. • Subsequently, the device may also affect medical treatment, image broadcasting by creating frequency noise. 	This appliance must be earthed. Do not connect the protective earth cable to a gas pipe, water pipe, lightning rod, or telephone earthing cable. If the unit is not properly earthed, the unit may malfunction due to electrical noise interference. It also poses a risk of electric shock, smoke, or fire.
Make sure that there is a main power switch and residual current circuit breaker (RCCB) for each unit. A ready accessible breaker for power source line helps reduce the risk of electric shock. Installation of a breaker is mandatory in some area.	

General caution

Do not install the unit in environments where large amounts of oil (including machine) or acidic/alkaline chemical sprays are present. These types of substances may cause device performance to be reduced and cause electrical shock, malfunction, smoke, or fire.

To reduce the risk of electric shock, fire, or malfunction, do not wash the unit with water or other types of liquids.

Wear protective gloves.

A high voltage is applied to the terminals. To reduce the risk of electric shock, wear protective gloves before touching the electrical parts on the unit.

Relocating/Repairing units

Consult your dealer or an authorized technician when the unit needs to be relocated or repaired.

Do not disassemble the unit or make any modifications/alterations to the unit.

Improper repair, modification, or alteration may cause injury, electric shock, or fire.



CAUTION

Transporting units/Unit installation

Do not install the unit where there is a risk of leaking flammable gas.

If flammable gas accumulates around the unit, it may ignite and cause a fire or explosion.

To reduce the risk of fire and malfunctions and to keep the unit from falling, do not install the unit where the unit may receive vibration or mechanical shock.

Take appropriate safety measures against earthquakes to prevent the unit from toppling over.

Unit installed on an unstable surface may fall and cause injury.

Electric work

Do not touch switches or other electrical parts with wet hands.

Doing so poses a risk of fire or electric shock.

General caution

To reduce the risk of electric shock, turn off the power before performing electric work.

To reduce the risk of injury, do not touch the edges of parts.

When replacing fuses, only use fuses with adequate breaking capacity.

The use of improperly rated fuses or a substitution of fuses with steel or copper wire may result in fire.

To reduce the risk of injury from accidentally dropped tools, check the surroundings before performing installation, inspection, and repairs, and keep children away from the site.

Important

To avoid deformation and malfunction, do not install the controller in direct sunlight or where the ambient temperature exceeds 55°C (131°F) or drops below -10°C (14°F).

Always use adequate tools for repair.

The use of unsuitable tools may result in failure to complete the job properly and cause unit damage or injury.

When connecting to the Internet, manage the security of the Internet.

To prevent unauthorized access, always use a security device such as a VPN router when connecting to the Internet.

To avoid malfunctions, do not bundle the power cable and signal transmission lines together, or put them in the same conduit.

To avoid fire, malfunction, and damage, do not connect the power cable to terminal block for signal cables.

Important

The PAC-YG50ECA expansion controller and the type of controllers that connect to the expansion controller via the LAN (e.g., AG-150A) each have a DB No. This 2-digit number is indicated on the package box and the controller. ([DB No.: **])
The DB number of the expansion controller can also be verified on its 7-segment controller.

Controllers with different DB No. cannot be connected to each other. Be sure to check the DB No. of each controller to be connected. Connection of two or more controllers that have different DB No. requires a controller software version update. Consult your dealer for how to update the software.

<Location of the DB No. (expansion controller)>

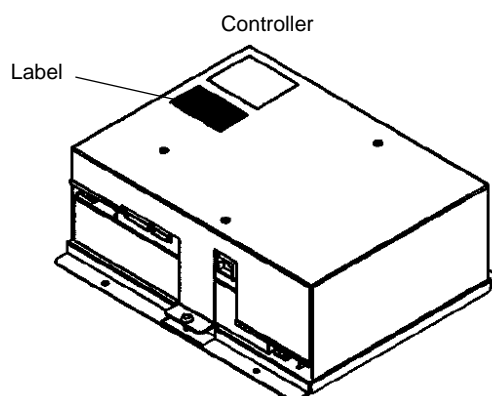
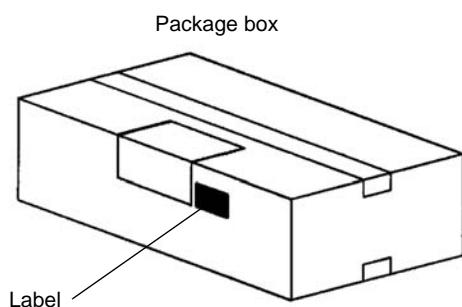

Label content

Serial number : * * * * - * * *
Ver. : * * . * *
DB No. : * *

<Ver.>と<DB No.>は出荷時点のものを記載しています。
<Ver.> and <DB No.> indicate factory default versions.

The DB No. is indicated here in two digits.

<Bringing up the DB No. on the 7-segment LED on the expansion controller>

On the switch board, set SW601 to "All OFF", SW606 to "2," and SW607 to "5." (Refer to page 19 for the location of each switch.)

The DB No. will appear on the 7-segment LED on the expansion controller.

Refer to (10) 7-segment LED for details.

- For instructions for how to verify the DB No. of the controllers (AG-150A etc.) that connect to the expansion controller via the LAN, refer to the Installation/Instructions Manuals that came with the controller.

1 Specifications

1-1. Product Specifications

Items		Specifications	
Power source	Rated input	100-240VAC \pm 10% 0.4-0.3A 50/60Hz	
	Fuse	250VAC 3.15A Time-delay Type (IEC127-2.S.S.5)	
Interface	Rated output of the power supply to M-NET transmission lines	22-30VDC	
	External input/output	12VDC or 24VDC (requires an external power supply)	
	LAN	100BASE-TX/10BASE-T	
	USB	USB1.1 supported	
Ambient conditions	Temperature	Operating temperature range	-10~55°C [14~131°F]
		Storage temperature range	-20~60°C [-4~140°F]
	Humidity		30 ~ 90%RH (Non-condensing)
Dimensions	217 (H) x 250 (W) x 97.2 (D) mm [8-9/16 (H) x 9-7/8 (W) x 3-7/8 (D) in.]		
Weight	2.6kg [5-3/4 lbs.]		
Installation conditions	Inside the control panel (indoor)		

1-2. External dimensions

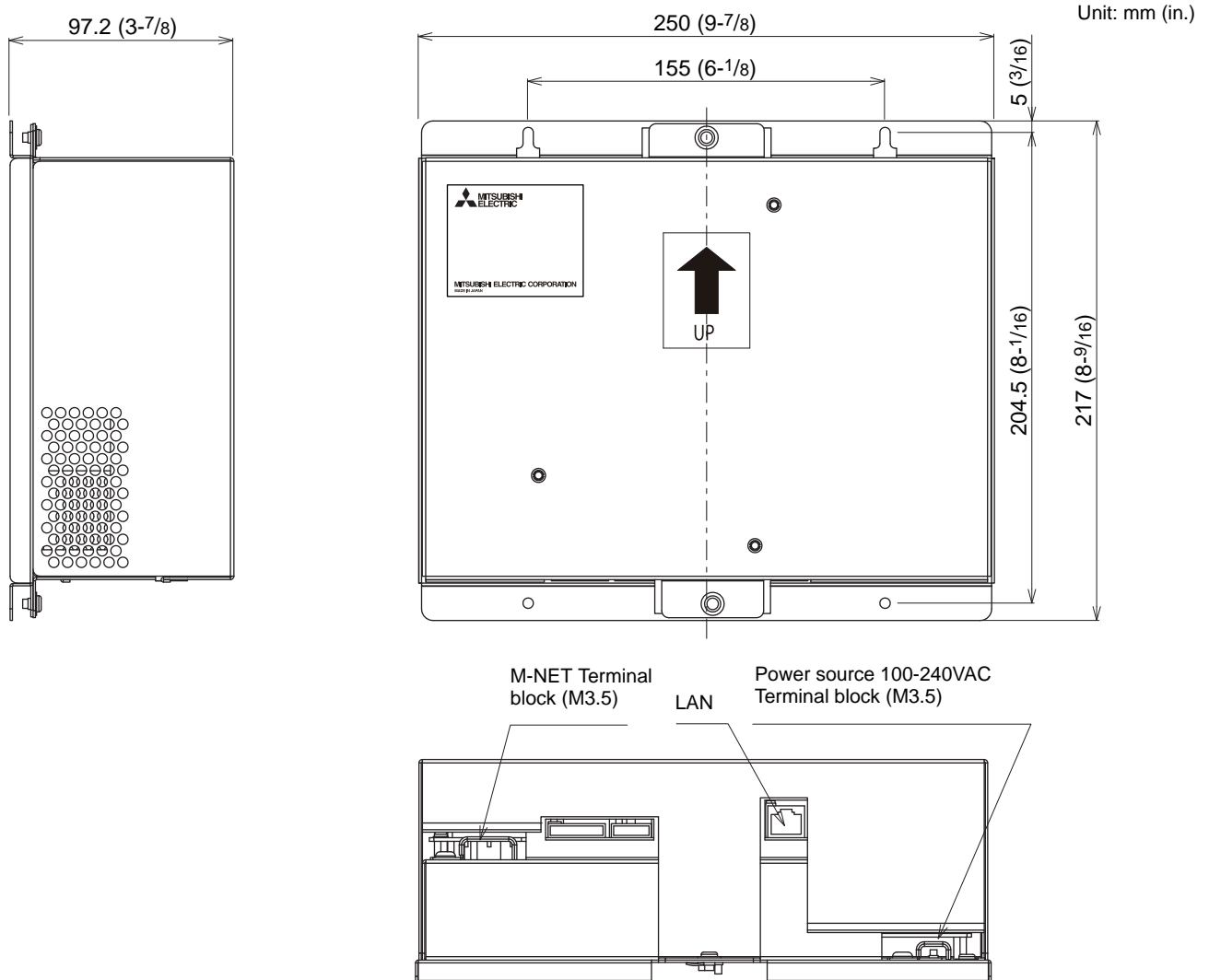

1-3. Supplying power to the M-NET transmission lines

PAC-YG50ECA has a built-in function to supply power to the M-NET transmission line. (power supply coefficient: 6)
 The total power consumption coefficient of the system controller and M-NET remote controller to which PAC-YG50ECA supplies power (See table 1) should not exceed the power supply coefficient of PAC-YG50ECA, which is six.

Table 1 Power consumption coefficient of the controller

System controller		M-NET remote controller
ON/OFF remote controller	System remote controller Schedule timer Group remote controller	ME remote controller LOSSNAY remote controller
1	0.5	0.25

Table 2 No. of connectable units

System controller		M-NET remote controller
ON/OFF remote controller	System remote controller Schedule timer Group remote controller	ME remote controller LOSSNAY remote controller
6 units	12 units	24 units

Table 3 No. of connectable units in systems with various combinations of remote controllers

V: connectable

		Total number of ON/OFF remote controllers						
		0	1	2	3	4	5	6
Total number of system remote controllers, schedule timers, and group remote controllers combined.	0	V	V	V	V	V	V	V
	1	V	V	V	V	V	V	
	2	V	V	V	V	V	V	
	3	V	V	V	V	V		
	4	V	V	V	V	V		
	5	V	V	V	V			
	6	V	V	V	V			
	7	V	V	V				
	8	V	V	V				
	9	V	V					
	10	V	V					
	11	V						
	12	V						

Note	<ul style="list-style-type: none"> When PAC-YG50ECA is connected to M-NET system, AG-150A/G(B)-50A cannot be connected to the same M-NET system.
-------------	---

2 System configuration

The figure below only shows the transmission line connections. Power supply lines are omitted.

Do not connect directly to the Internet. When connecting to the Internet through the AG-150A etc., use a security device such as a VPN router.

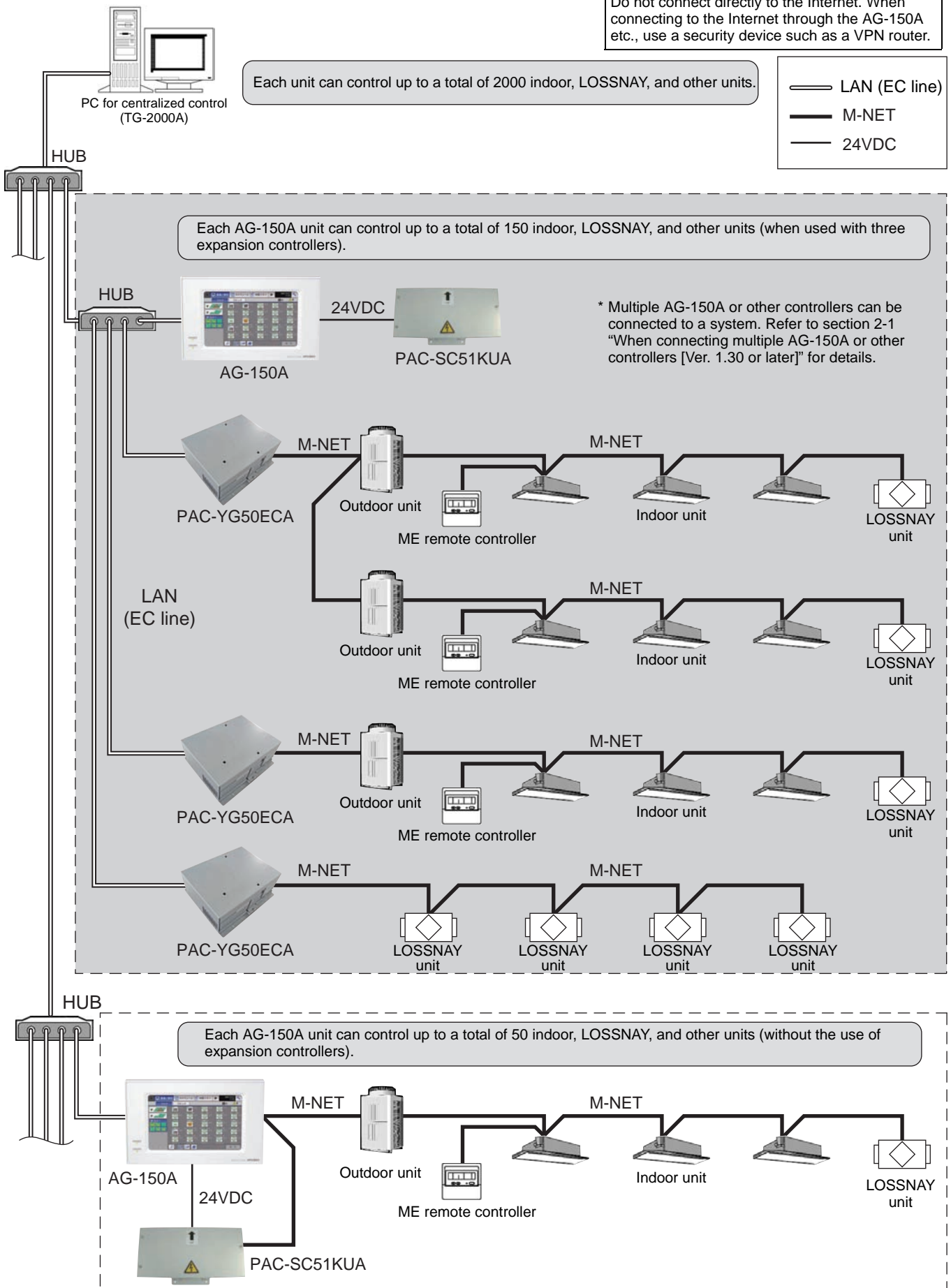

2-1. When connecting multiple AG-150A or other controllers [Ver. 1.30 or later]

Multiple AG-150A or other controllers can be connected to an air conditioning system, and each controller can control the system.

Note that the number of connectable units and the software version is limited.

If the software version is unsupported, update the software version of the controllers.

(1) Restrictions on the number of connectable units

The total number of AG-150A or other controllers should be three or less.

(2) Restrictions on the software version

No. of connectable units	PAC-YG50ECA	3 units or less	
	AG-150A	1 unit	2 or 3 units
Software version	PAC-YG50ECA	Ver. 1.00 or later	Ver. 1.30 or later
	AG-150A	Ver. 2.00 or later	Ver. 2.30 or later

Refer to the controller manual for other connectable controller models and compatible software versions.

(3) Restrictions on the DB No.

Controllers with different DB No. cannot be connected to each other. Refer to section "Important"(page 4) for details.

(4) Miscellaneous restrictions

- Controllers such as AG-150A connected to a system must have the same settings for the settings such as Group or Interlocked ventilation.
- Different settings for the settings such as Group or Interlocked ventilation cannot be made in a system.
- When connecting a DIDO controller to a system, register the same group to each AG-150A connected to a system.
- Use only one AG-150A to make group settings for other units.
- Use only one AG-150A to register license and make settings.
- Icons that indicate schedule, energy-save mode, and setback mode enabled appear only on the AG-150A that controls these modes.

System example when connecting multiple AG-150A

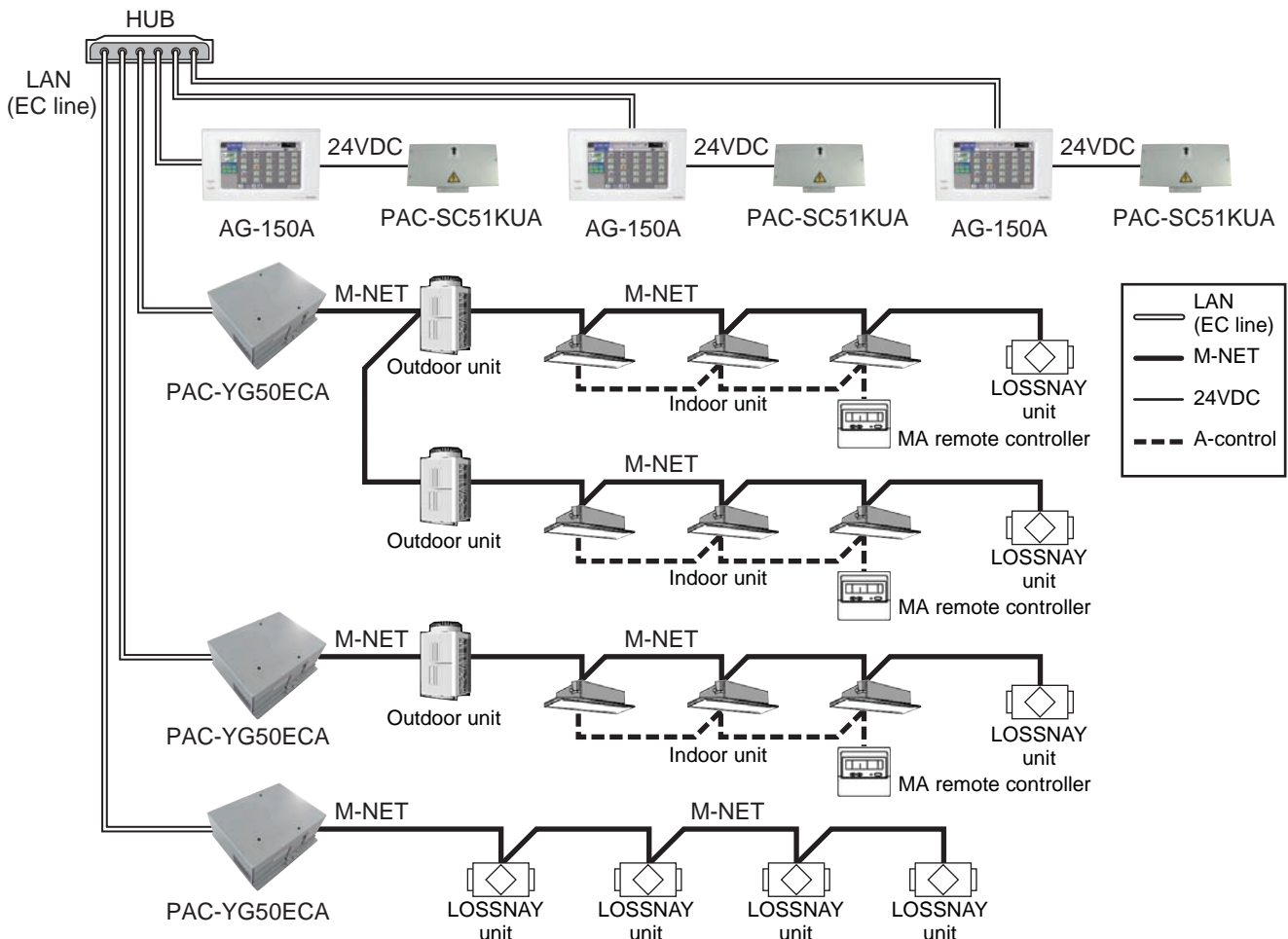

2-2. Setting M-NET address for various devices

The same address cannot be used more than once within the same system of the expansion controller (PAC-YG50ECA). (K-control units and K-control remote control addresses are excluded.)

	Address setting method	M-NET address
Indoor unit	Assign the lowest address to the main indoor unit in the group, and assign sequential addresses to the rest of the indoor units in the same group.	1 ~ 50
Outdoor unit	Assign an address that equals the lowest indoor unit address in the same refrigerant group plus 50.	51 ~ 100
Auxiliary outdoor unit (BC controller etc.)	Assign an address that equals the address of the outdoor unit in the same refrigerant system plus 1.	52 ~ 100
OA processing unit/ LOSSNAY	Assign an arbitrary but unused address to each of these units after assigning an address to all indoor units.	1 ~ 50
Mr.Slim outdoor unit	Make the settings in the same way as with the indoor units. Requires an M-NET adapter (sold separately).	1 ~ 50
M-NET remote controller	Assign an address that equals the address of the main indoor unit with the lowest address in the group plus 100. Add 150 in stead of 100 to set the address for a sub remote controller.	101 ~ 200
MA remote controller	Address setting is not required. Connection of two remote controllers requires the main/sub setting for each controller to be made.	–
Sub system controller	Assign an address that equals the group number of the smallest controlled group plus 200.	201 ~ 250
DIDO controller (PAC-YG66DCA)	Assign an arbitrary but unused address to the controller after completing the address setting for the units with an address between 1 and 50. The number of controllable units changes with the number of channels used.	1 ~ 50
PI controller (PAC-YG60MCA)	Assign an arbitrary but unused address to the controller after completing the address setting for the units with an address between 1 and 50.	1 ~ 50
AI controller (PAC-YG63MCA)	Assign an arbitrary but unused address to the controller after completing the address setting for the units with an address between 1 and 50.	1 ~ 50
K-control indoor unit	Assign an address to all indoor units connected to the M-NET lines (incl. LOSSNAY units) first, and then assign addresses to the K-control indoor units, starting with the address after the last address.	1 ~ 50
K-control remote controller	Assign an address as the lowest address of the K-control indoor units in the same group.	1 ~ 50
K-transmission converter	Assign an address that equals the lowest K-control indoor unit address plus 200.	201 ~ 250

Important	<ul style="list-style-type: none"> ● Check that the setting for the central control switch SW2-1 on the M-NET outdoor unit is set to "ON." (Refer to the outdoor unit Installation Manual for the detailed information about dip switch settings.) ● Note the following when using a K-transmission converter (model: PAC-SC25KAA) to control the K-control units. Refer to the K-transmission converter Installation Manual for details. <ol style="list-style-type: none"> ① Be sure to set the PAC-YG50ECA address to "000." ② Set the "K-transmission converter connection setting" (to be set from a Main controller) to ON (with a connection to K-transmission converter). When this setting is set to ON, an address field will appear. Enter the K-transmission converter address in the field. ③ Assign addresses to the K-control air conditioners so that they are larger than the addresses that are assigned to the M-control indoor units. ④ Make the group settings for K-control units so that the group number equals the lowest address of the indoor units within the group. ⑤ If the K-control Y series units and other types of units (K-control Mr. Slim) are used in combination, a relay board is required. The K-control Y series of units and other types of units cannot be connected to the same transmission line. ⑥ A relay board may be required, depending on the number of K-control units and the length of transmission lines. Refer to the System Design Manual (control version) for details. ⑦ LOSSNAY units that are connected to the general K-control kit cannot be connected. ⑧ Remote controller addresses is not required in the group setting for the K-control models.
------------------	--

Note	<ul style="list-style-type: none"> ● A-control jet burner models cannot be controlled. ● Some models cannot be controlled. ● Main system controllers, such as the AG-150A, cannot be connected to a M-NET system that is controlled by the expansion controller.
-------------	---

* Main and Sub system controllers (M-NET)
 PAC-YG50ECA can be used only as the Main controller, not as a Sub controller.

- Main system controller (Main SC)
 Main SC refers to a controller that controls all other system controllers including the units they control. If a given system has only one system controller, that controller becomes a Main controller. Group settings and interlock settings can be made only from a Main controller.
- Sub system controller (Sub SC)
 Sub controller refers to a system controller that is controlled (including the units it controls) by a Main system controller.

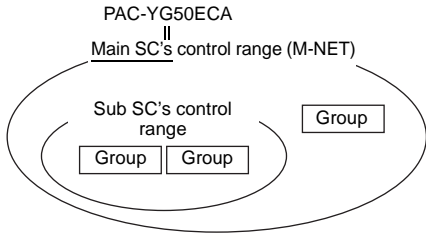

PAC-YG50ECA is exclusively for use as a Main SC. It cannot be used as a Sub SC or controlled from a Main SC.

Note

- Groups that are not under the control of a Main controller cannot be controlled from a Sub controller.

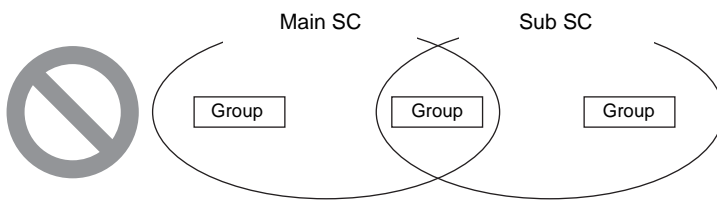

- Each group cannot be placed under the control of two or more Main controllers.

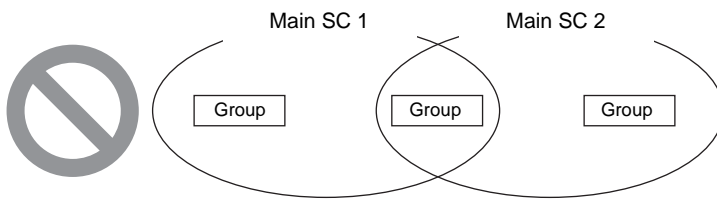

- Sub controllers cannot be placed under the control of two or more Main controllers.

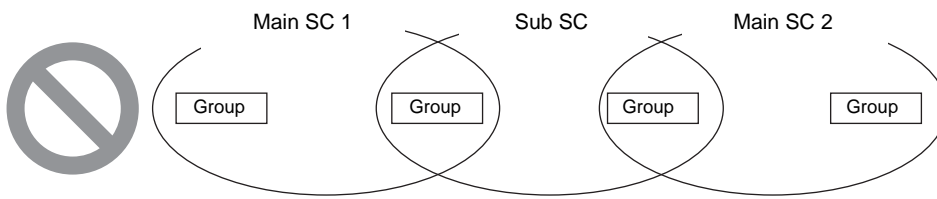

3 Installation

3-1. Field-supplied parts

The following parts are required to install the unit.

Required parts	Specification								
Power cable/ protective earth cable	Power supply cable of appliances shall not be lighter than design 245 IEC 57 or 227 IEC 57. Cable size: 0.75mm ² to 2mm ²								
M-NET transmission line	Shielded cable <ul style="list-style-type: none"> • CPEVS: ϕ1.2mm to ϕ1.6mm • CVVS: 1.25mm² to 2mm² 								
Ring terminal (with a sleeve)	M3.5 terminal (used with the power cable (L/L1, N/L2), M-NET transmission line (A, B, S)) M4 ring terminal (used with the protective earth cable)								
Screw	Have four M4 screws ready to install the unit.								
LAN cable	Category 5 or above straight cable (Maximum 100m (328 ft))								
HUB	Switching HUB (communication speed: 100 Mbps or faster is recommended.)								
Overcurrent breaker and Residual Current Circuit Breaker (RCCB)	<table border="1" style="width: 100%; border-collapse: collapse;"> <thead> <tr> <th colspan="2">Overcurrent breaker</th> <th rowspan="2">Residual Current Circuit Breaker (RCCB)^{*1 *3}</th> </tr> <tr> <th>Fuse</th> <th>Circuit breaker^{*1}</th> </tr> </thead> <tbody> <tr> <td>Rated current: 3A^{*2}</td> <td>Rated current: 3A</td> <td>Rated sensitivity current: 30mA Maximum operation time: 0.1 sec or less</td> </tr> </tbody> </table>	Overcurrent breaker		Residual Current Circuit Breaker (RCCB) ^{*1 *3}	Fuse	Circuit breaker ^{*1}	Rated current: 3A ^{*2}	Rated current: 3A	Rated sensitivity current: 30mA Maximum operation time: 0.1 sec or less
	Overcurrent breaker		Residual Current Circuit Breaker (RCCB) ^{*1 *3}						
Fuse	Circuit breaker ^{*1}								
Rated current: 3A ^{*2}	Rated current: 3A	Rated sensitivity current: 30mA Maximum operation time: 0.1 sec or less							
	<p>*1 Use a Circuit breaker and a Residual current circuit breaker (RCCB) of bipolar type (2P2E). Use a breaker with the minimum contact distance of 3 mm (1/8 in.).</p> <p>*2 When using a fuse, use it in combination with a main switch (Rated current: 3A).</p> <p>*3 Normally, maximum leakage current of one PAC-YG50ECA is 2 mA. Select and install the earth leakage breaker, considering the rated current of overcurrent breaker and the leakage current of power cables.</p>								

3-2. M-NET transmission line length

- Connect the PAC-YG50ECA to the transmission line for centralized control (TB7 on the outdoor unit).
- There should only be one power supply source within a single M-NET transmission circuit. The factory setting is to supply power from PAC-YG50ECA.
- Provide an earth for the indoor-outdoor transmission lines at one single outdoor unit.
- Maximum line distance 500 m (1640 ft)^{*1}
- Maximum power supply distance 200 m (656 ft)^{*1}

Maximum power supply distance is the distance in which a power supply unit (or an outdoor unit designated as a power supply unit) is capable of supplying power to other units on the receiving end, such as remote controllers and indoor units.

Wiring example

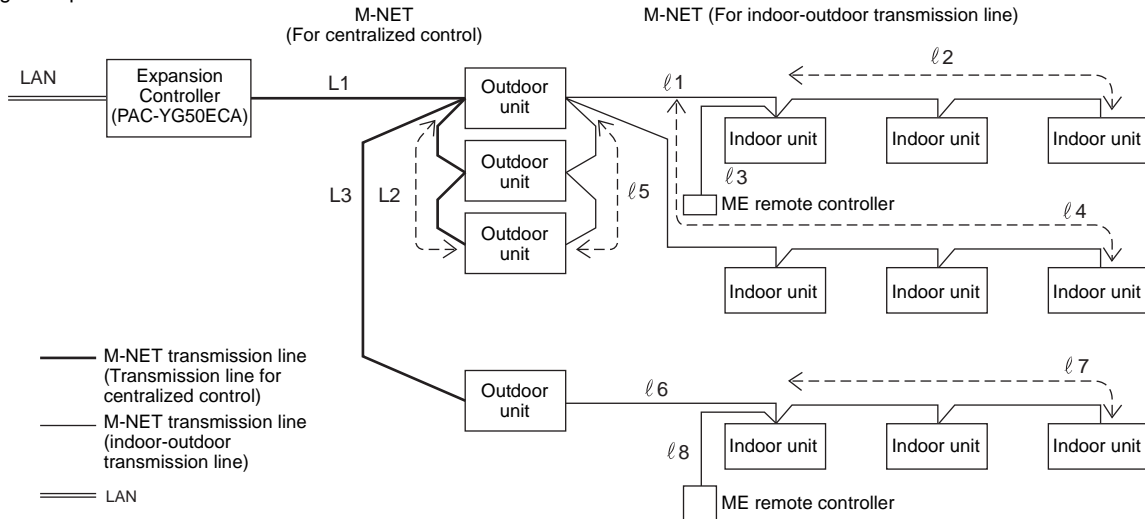

(1) Maximum line distance

- | | |
|--|------------------------------|
| ① $L1 + L2 + l5 + l1 + l2$ ($l3$) | $\leq 500\text{m}$ (1640 ft) |
| ② $L1 + L2 + l5 + l4$ | $\leq 500\text{m}$ (1640 ft) |
| ③ $L1 + L3 + l6 + l7$ ($l8$) | $\leq 500\text{m}$ (1640 ft) |
| ④ $l2$ ($l3$) + $l1 + l5 + L2 + L3 + l6 + l7$ ($l8$) | $\leq 500\text{m}$ (1640 ft) |
| ⑤ $l4 + l5 + L2 + L3 + l6 + l7$ ($l8$) | $\leq 500\text{m}$ (1640 ft) |

* Connect the power jumper of the outdoor unit to CN41 (does not supply power).

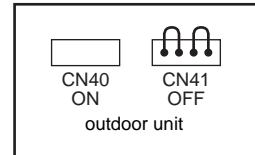

(2) Power supply distance for the indoor-outdoor transmission lines

- | | |
|---------------------------|-----------------------------|
| ① $l5 + l1 + l2$ ($l3$) | $\leq 200\text{m}$ (656 ft) |
| ② $l5 + l4$ | $\leq 200\text{m}$ (656 ft) |
| ③ $l6 + l7$ ($l8$) | $\leq 200\text{m}$ (656 ft) |

(3) Power supply distance for the centralized control transmission lines

- | | |
|-------------|-----------------------------|
| ① $L1 + L2$ | $\leq 200\text{m}$ (656 ft) |
| ② $L1 + L3$ | $\leq 200\text{m}$ (656 ft) |

Important

^{*1} The ME remote controller wiring length ($l3$, $l8$) should be 10 m (32 ft) or less. The length that exceeds 10 m (32 ft) needs to be included in the maximum distance to the farthest unit (500 m (1640 ft)) and in the maximum power supply distance (200 m (656 ft)).

3-3. Installation

- Leave enough space around the unit as shown in the figure below to allow for an installation/uninstallaion of the cover and wiring.
- Screw down the cover with M4 screws as shown in the figure below.
Be sure to screw down the four corners to prevent it from falling.
- Install on the control panel whose effective depth is 105 mm (4-3/16 in.) or more.

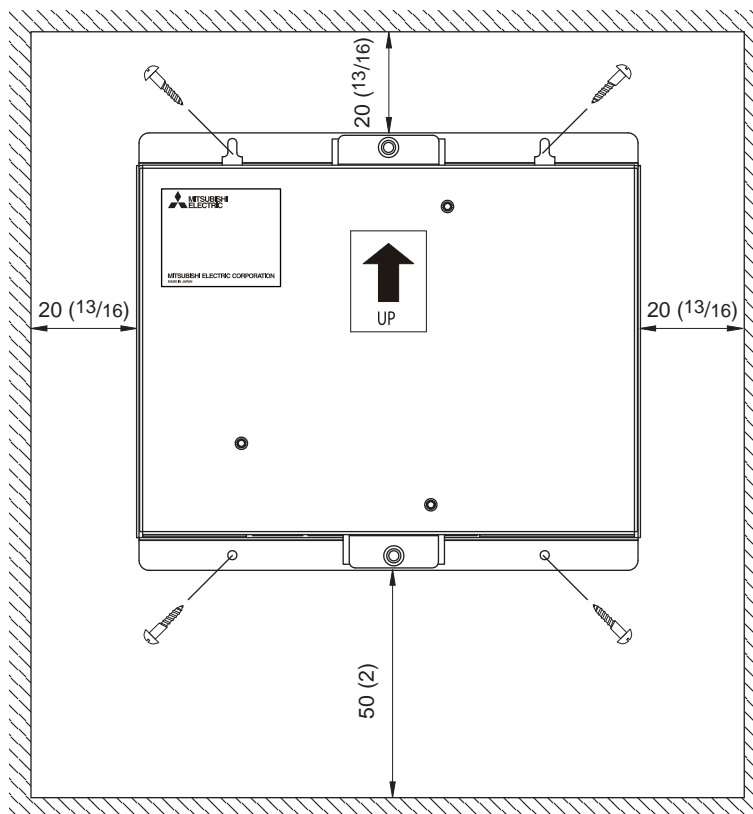

Unit: mm (in.)

* Refer to section **1** Specifications for the product dimensions and weight.

Properly install the unit on a stable, load-bearing surface.
Unit installed on an unstable surface may fall and cause injury.

To reduce the risk of fire and malfunctions and to keep the unit from falling, do not install the unit where the unit may receive vibration or mechanical shock.

Important :

PAC-YG50ECA is not water-proof.
Be sure to install it inside the control panel.

Be sure to install it inside the control panel. Be sure to install in an area where there is no possibility of dew condensation.

4 Wiring connections

⚠ WARNING

- Electric work must be performed by an authorized technician. Improper wiring work may result in electric shock or fire.
- Turn off the power supply before performing wiring work.

⚠ CAUTION

- To avoid damage to the terminal block, do not connect an AC power supply (100-240VAC) to the M-NET transmission terminal block.

4-1. Installing and uninstalling the cover

Unscrew the two screws on the cover to remove it as shown in the figure below. Reinstall the cover using the two screws that were unscrewed.

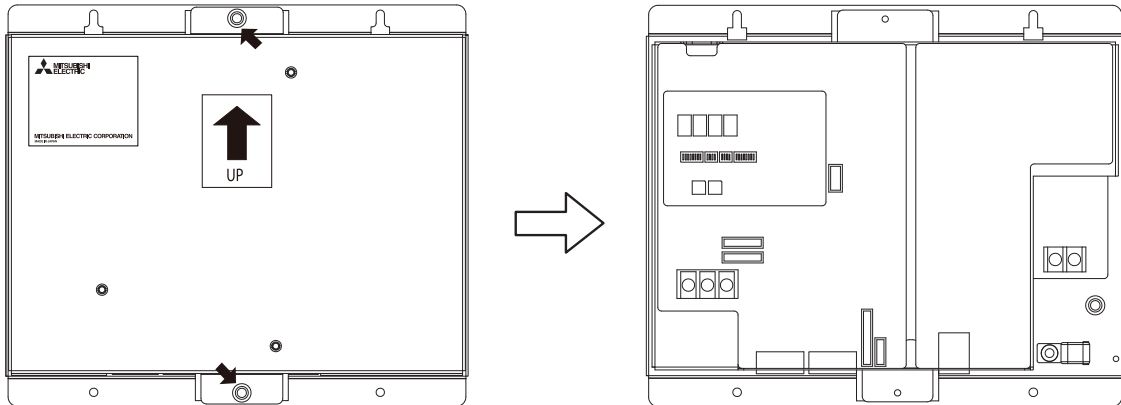

4-2. Connecting the power cable and protective earth cable

⚠ WARNING

To prevent overheating and fire, properly fix the cables in place so that the weight of the cables will not strain the connectors.

Improperly connected cables may break, produce heat, and cause smoke or fire.

- Connect the power cable and the protective earth cable as shown in the figure below.
- Use an M3.5 ring terminal to the power cable and an M4 ring terminal to the protective earth cable before connecting them to their corresponding terminals (power supply terminal block or protective earth terminal).
- Secure cables with cable clamps.
- Install an overcurrent breaker and a residual current circuit breaker for the power cable. Use a bipolar breaker (2P2E) with a minimum contact distance of 3 mm (1/8 in.).

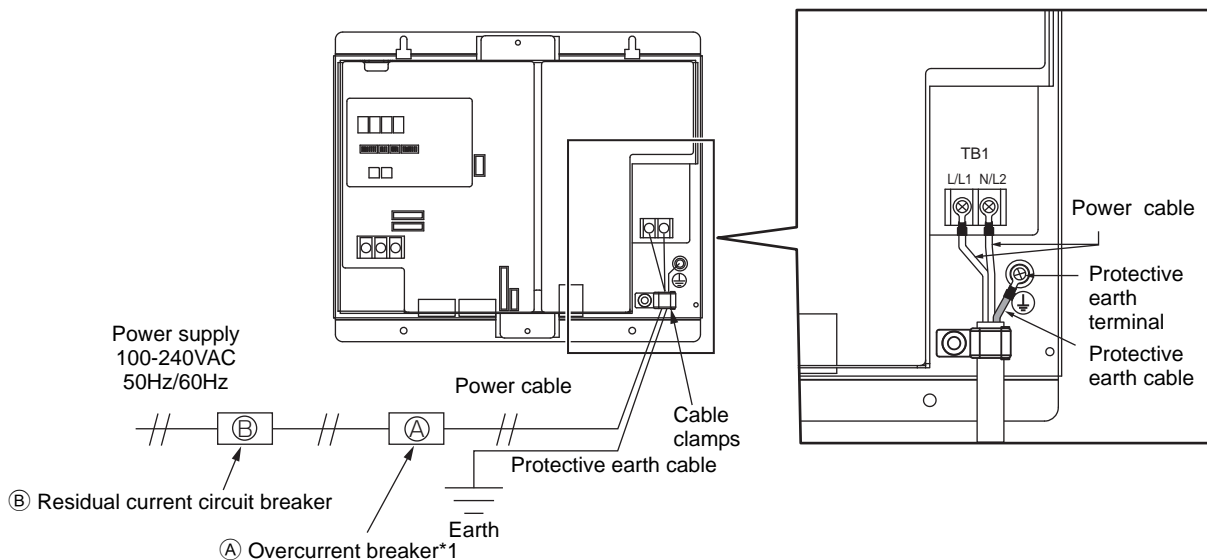

*1 When using a fuse, use it in combination with a main switch (Rated current: 3A).

4-3. Connecting the M-NET transmission line

CAUTION • In an air conditioner system has more than 1 Outdoor units, System controller receiving transmission power through TB7 on one of the Outdoor unit would have a risk that the connected Outdoor units failure would stop power supply to System controller, and disrupt the whole system.

(1) To supply power to the M-NET transmission line from the expansion controller (PAC-YG50ECA)

Connect the M-NET transmission lines as shown in the figure below.

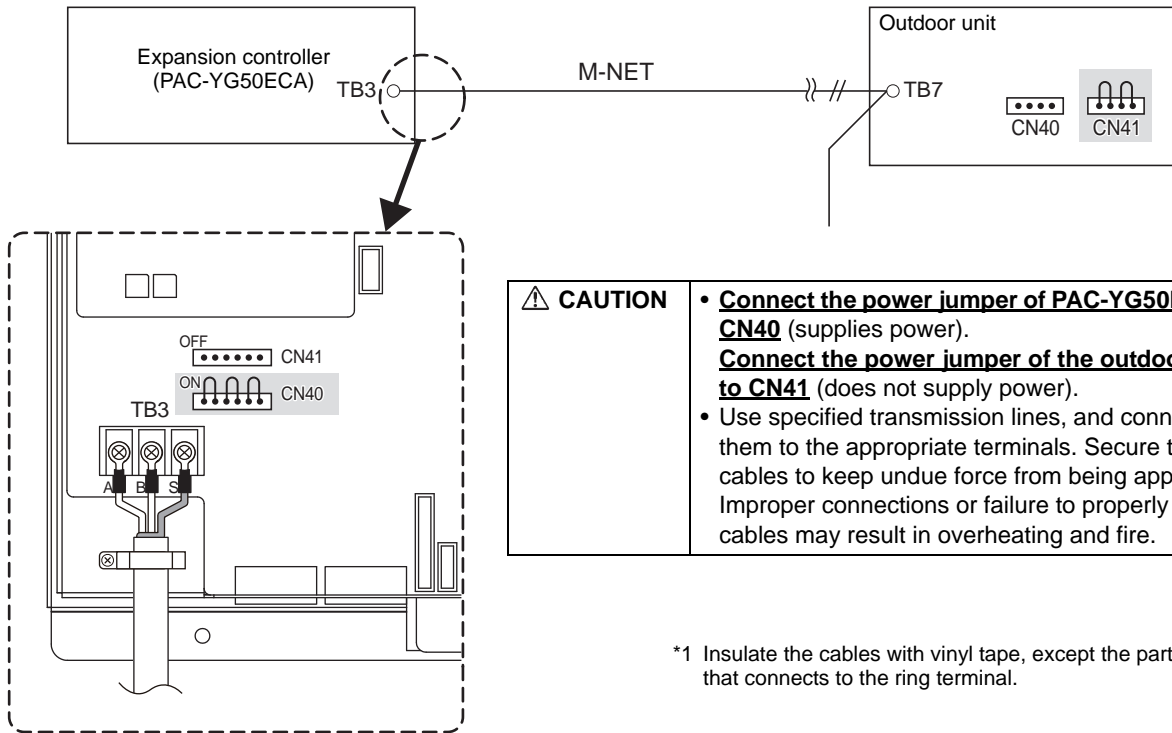

CAUTION

- **Connect the power jumper of PAC-YG50ECA to CN40** (supplies power).
- **Connect the power jumper of the outdoor unit to CN41** (does not supply power).
- Use specified transmission lines, and connect them to the appropriate terminals. Secure the cables to keep undue force from being applied. Improper connections or failure to properly secure cables may result in overheating and fire.

*1 Insulate the cables with vinyl tape, except the part that connects to the ring terminal.

(2) To supply power to the M-NET transmission line from the power supply unit (PAC-SC51KUA, etc.)

Connect the M-NET transmission lines as shown in the figure below.

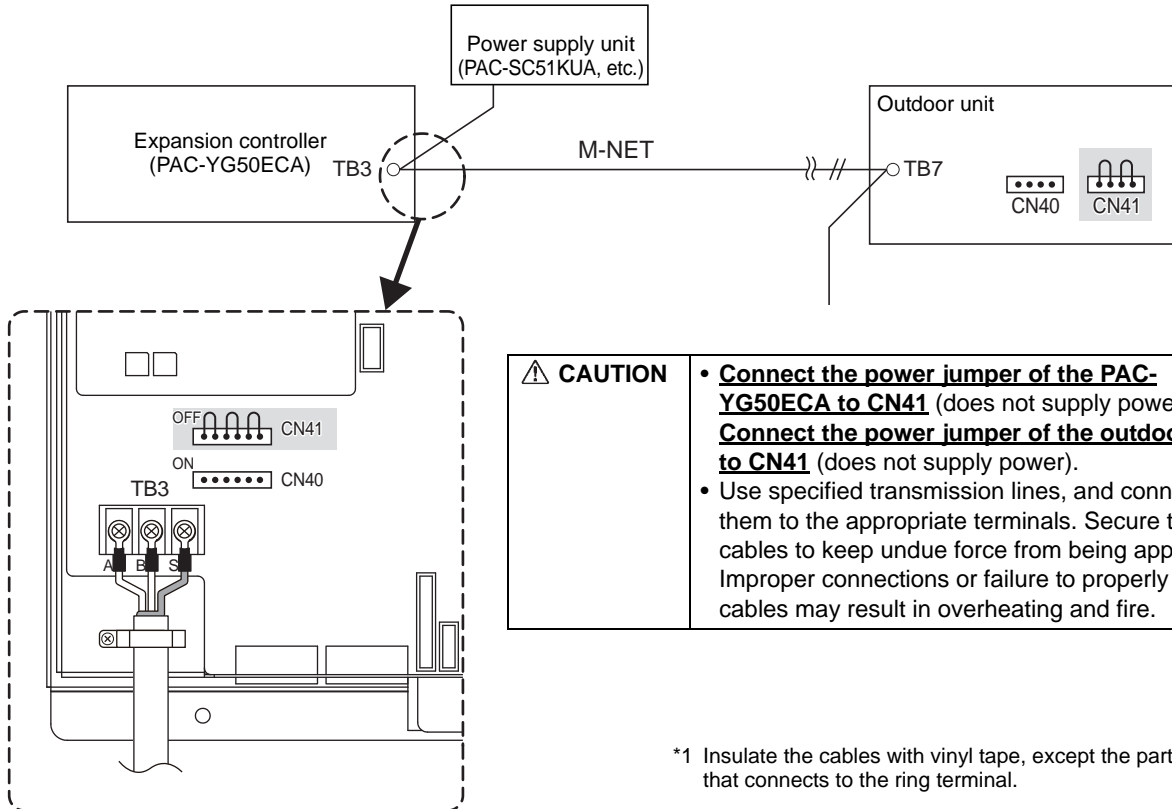

CAUTION

- **Connect the power jumper of the PAC-YG50ECA to CN41** (does not supply power).
- **Connect the power jumper of the outdoor unit to CN41** (does not supply power).
- Use specified transmission lines, and connect them to the appropriate terminals. Secure the cables to keep undue force from being applied. Improper connections or failure to properly secure cables may result in overheating and fire.

*1 Insulate the cables with vinyl tape, except the part that connects to the ring terminal.

4-4. Connecting the LAN cable

Connect the LAN cable to the LAN connector on the PAC-YG50ECA.

- Connect the PAC-YG50ECA and AG-150A via a HUB.
- The maximum distance between the HUB and PAC-YG50ECA is 100 m (328 ft).
- The LAN cable is field-supplied. Use a category 5 or above cable (straight cable).
- Use the switching HUB.
- The recommended number of connected devices between AG-150A and PAC-YG50ECA is four or less. (Transmission round-trip delay time must not exceed four seconds. If the transmission delay time is long, a communication error may be detected.)

If five or more devices such as HUB are connected, refer to section 4-5 “Confirming the LAN transmission delay time.”

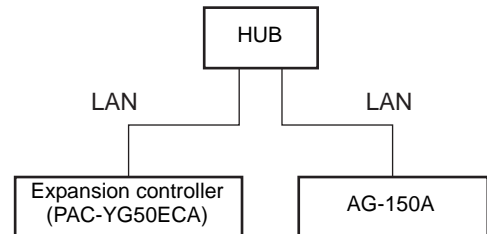
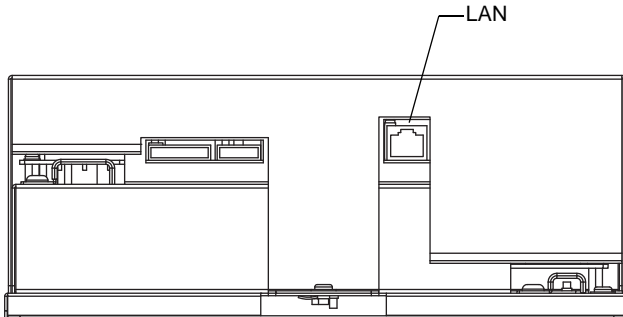

CAUTION	<ul style="list-style-type: none"> • Install the LAN cable before installing the unit, and route the cable in the same way as the M-NET transmission lines. • Leave enough space around the LAN port on the PAC-YG50ECA to allow for the connection of the connector and the cables. Refer to section (3) Installation.
----------------	---

4-5. Confirming the LAN transmission delay time

Connect a monitoring PC to a device such as HUB that is connected to AG-150A or other controllers. Send a command from the PC to the PAC-YG50ECA, and receive the response from the PAC-YG50ECA. Check the time between sending and receiving on the PC display.

Notes	<ol style="list-style-type: none"> (1) IP address of the monitoring PC should not overlap any of the addresses that are assigned to the controllers such as AG-150A or PAC-YG50ECA. (2) When connecting to an existing LAN system, which does not use a dedicated LAN, consult the network administrator to obtain the permission to connect the monitoring PC and the temporary IP address for the PC.
--------------	---

4-5-1. Sample system connection

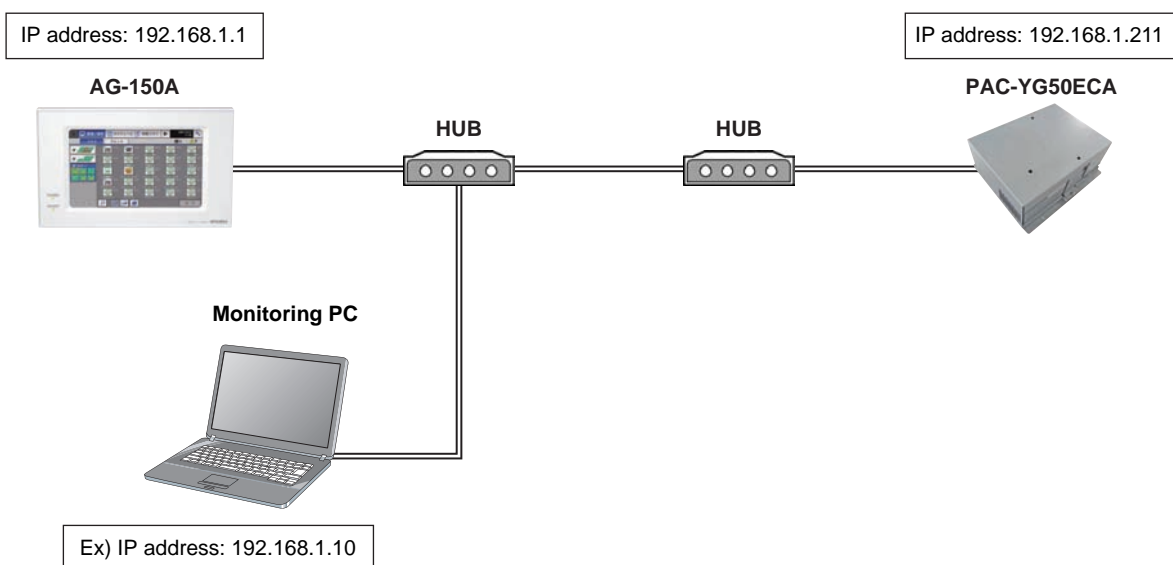

4-5-2. Example of how to check the transmission delay time

- (1) Select [Command Prompt] from [Start] > [Program] > [Accessory] on the monitoring PC.
- (2) Enter [ping (IP address of PAC-YG50ECA)], and press the [enter] button.
([ping 192.168.1.211] is entered on the sample screen below.)
- (3) Check that the transmission delay time that appears on the screen is maximum 4000 ms. (See the sample screen below.)
(The transmission delay time is maximum 2 ms on the sample screen below, which is normal.)

```
Microsoft Windows XP [Version 5.1.2600]
(C) Copyright 1985-2001 Microsoft Corp.

C:\Documents and Settings\test>ping 192.168.1.211

Pinging 192.168.1.211 with 32 bytes of data:

Reply from 192.168.1.211: bytes=32 time=2ms TTL=255
Reply from 192.168.1.211: bytes=32 time=1ms TTL=255
Reply from 192.168.1.211: bytes=32 time<1ms TTL=255
Reply from 192.168.1.211: bytes=32 time<1ms TTL=255

Ping statistics for 192.168.1.211:
    Packets: Sent = 4, Received = 4, Lost = 0 (0% loss),
    Approximate round trip times in milli-seconds:
        Minimum = 0ms, Maximum = 2ms, Average = 0ms

C:\Documents and Settings\test>
```

Enter [ping 192.168.1.211], and press the [enter] button.

Check the transmission delay time display. The time should be maximum 4000 ms.

```
Microsoft Windows XP [Version 5.1.2600]
(C) Copyright 1985-2001 Microsoft Corp.

C:\Documents and Settings\test>ping 192.168.1.211

Pinging 192.168.1.211 with 32 bytes of data:

Request timed out.
Request timed out.
Request timed out.
Request timed out.

Ping statistics for 192.168.1.211:
    Packets: Sent = 4, Received = 0, Lost = 4 (100% loss),

C:\Documents and Settings\test>
```

If [Request timed out] appears, check the LAN connection status and IP address.

If [Request timed out] appears or the displayed transmission delay time exceeds 4000 ms, consult the network administrator for how to decrease the number of gateway, router, layer 3 switch, or HUB or how to change the network.

5 Initial settings

Introduction

Controllers with different DB numbers cannot be connected to each other.

Be sure to check the DB numbers of each controller to be connected.

Refer to "Important" (page 4) and (10 | 7-segment LED) to check the DB No..

Initial setting procedures

Steps	Setting items	Controllers used for setting ○: Settable	
		Expansion controller (PAC-YG50ECA) ^{*3}	AG-150A etc. ^{*4}
1	IP address of the expansion controller/Network	○ Refer to section 5-1 "IP address and network settings for PAC-YG50ECA."	—
	Default settings: IP address 192.168.1.211 Subnet mask 255.255.255.0 Gateway address 0.0.0.0		
2	Turning on the power to the controllers such as PAC-YG50ECA or AG-150A	○	○
3	IP address for the AG-150A etc. and network	—	○ Refer to the manual for a controller such as AG-150A.
4	Input IP address of expansion controller	—	○ Refer to the manual for a controller such as AG-150A.
5	M-NET address setting for the expansion controller Default: 00 Normally requires no setting changes.	○ ^{*2} Refer to section (9 Detail setting switch setting method)	○ ^{*1} Refer to the manual for a controller such as AG-150A.
6	Functions (Operation prohibit range setting, external input mode etc.)	—	○ ^{*1} Refer to the manual for a controller such as AG-150A.
7	Group	—	○ ^{*1} Refer to the manual for a controller such as AG-150A.
8	Interlocked ventilation	—	○ ^{*1} Refer to the manual for a controller such as AG-150A.
9	Clock setting ^{*6}	—	○ Refer to the manual for a controller such as AG-150A.
10	Test run	○ ^{*2} Refer to section 6-1 "Batch operation/ Stop (error reset) switches."	○ Refer to the manual for a controller such as AG-150A.
11	Prohibiting the connection of additional controllers such as AG-150A	○ ^{*5} Refer to section 5-2-3 "Prohibiting the connection of additional controllers such as AG-150A (SW603-4)."	—

* Refer to the AG-150A Instructions Manual, Technical Manual, and other related manuals for the detailed information about the initial settings and operation methods.

*1: To be set from only one of the controllers such as AG-150A.

*2: It is recommended that this item be set from the AG-150A or other controllers.

*3: Be sure to install the controller with a connection to the controllers such as AG-150A.

*4: Refer to section 2-1 "When connecting multiple AG-150A or other controllers [Ver. 1.30 or later]" for restrictions.

*5: When connecting two or more controllers such as AG-150A, set the controllers to disallow the connection of additional controllers after all controllers complete the initial setting.

*6: When the clock setting is made, the setting will be reflected on the clocks on other units that are connected to the M-NET line and on the AG-150A controller whose "Time master setting" is set to Sub.

Internal layout of the expansion controller

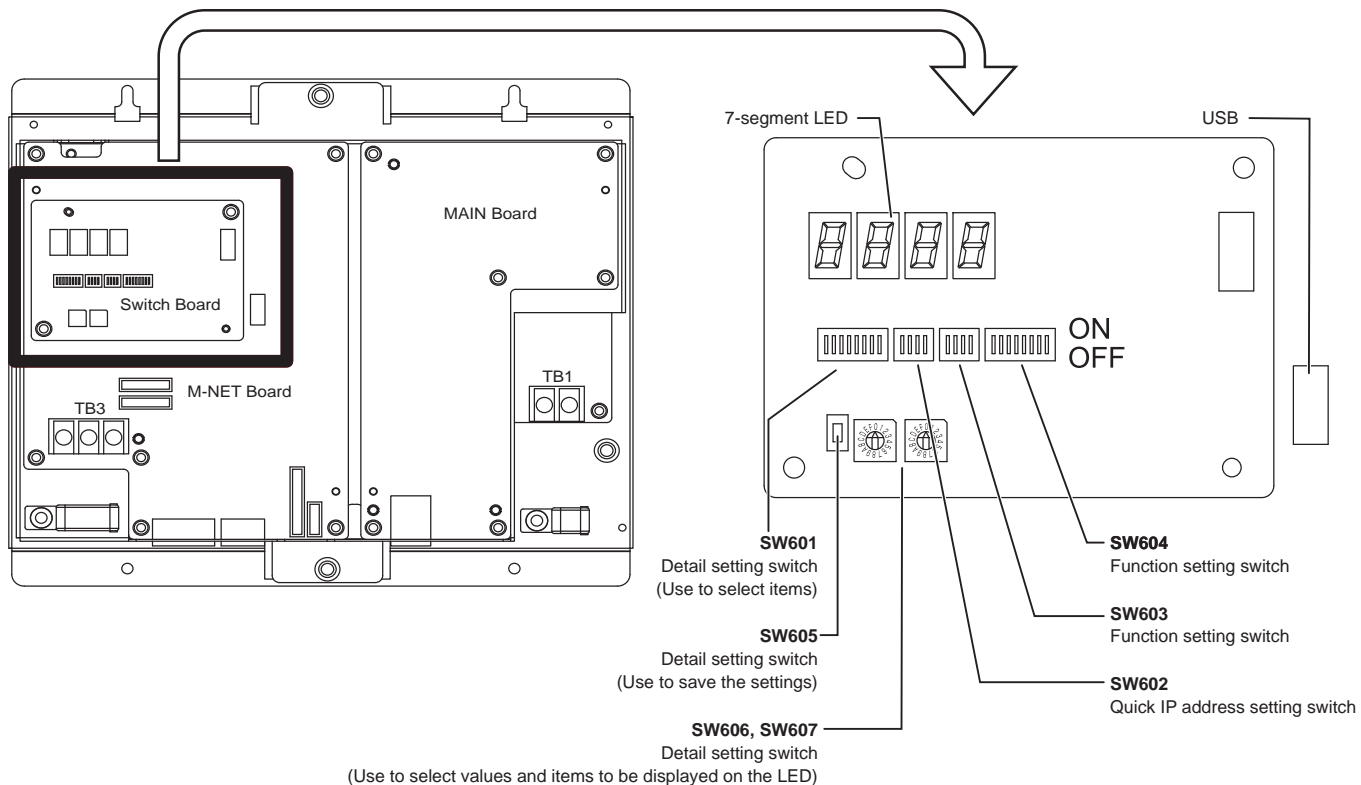

5-1. IP address and network settings for PAC-YG50ECA

When connecting PAC-YG50ECA, AG-150A, or other controllers to a dedicated LAN system (Refer to 5-1-3 ①), set the IP address and network settings for PAC-YG50ECA with “Quick IP address setting switch.” (Refer to section 5-1-1 “Quick IP address setting switch.”)

When connecting to an existing LAN system (Refer to 5-1-3 ②) or settings cannot be made with Quick IP address setting switch, set them with the detail setting switches. (Refer to section 5-1-2 “Setting the IP address or network settings with the detail setting switches.”)

5-1-1. Quick IP address setting switch

IP address can be easily set to an address between 192.168.1.211 and 192.168.1.225 with dipswitch SW602. Set this dipswitch before turning on the power.

NO	SW602 [0: OFF, 1: ON]				IP address	Subnet mask	Gateway address
	1	2	3	4			
1	0	0	0	1	192.168.1.211	255.255.255.0	0.0.0.0
2	0	0	1	0	192.168.1.212		
3	0	0	1	1	192.168.1.213		
4	0	1	0	0	192.168.1.214		
5	0	1	0	1	192.168.1.215		
6	0	1	1	0	192.168.1.216		
7	0	1	1	1	192.168.1.217		
8	1	0	0	0	192.168.1.218		
9	1	0	0	1	192.168.1.219		
10	1	0	1	0	192.168.1.220		
11	1	0	1	1	192.168.1.221		
12	1	1	0	0	192.168.1.222		
13	1	1	0	1	192.168.1.223		
14	1	1	1	0	192.168.1.224		
15	1	1	1	1	192.168.1.225		
16	0	0	0	0	Initial settings: 192.168.1.211	Initial settings: 255.255.255.0	Initial settings: 0.0.0.0

Use the detail setting switch to set the IP address, subnet mask, and gateway address.

Note	<ul style="list-style-type: none"> ● If fifteen or fewer expansion controllers are connected to a dedicated network, it is recommended that the IP address be set with SW602. ● Turn all SW602 to OFF before setting the IP addresses with the detail setting switch (refer to section 5-1-2).
-------------	--

5-1-2. Setting the IP address or network settings with the detail setting switches

IP address, subnet mask, or gateway address can be set with dipswitch SW601, rotary switches SW606 and 607, and push switch SW605. Quick IP address setting switches (SW602) should be set to “ALL OFF” to make these settings.

Consult the network administrator for how to set the IP address, subnet mask, and gateway address when connecting the expansion controller to an existing LAN.

Refer to section (9 | Detail setting switch setting method) for how to set the switches.

5-1-3. IP address and network setting examples

① Connecting to a dedicated LAN system

If fifteen or fewer expansion controllers are connected to a dedicated network, it is recommended that the IP address be set with SW602.

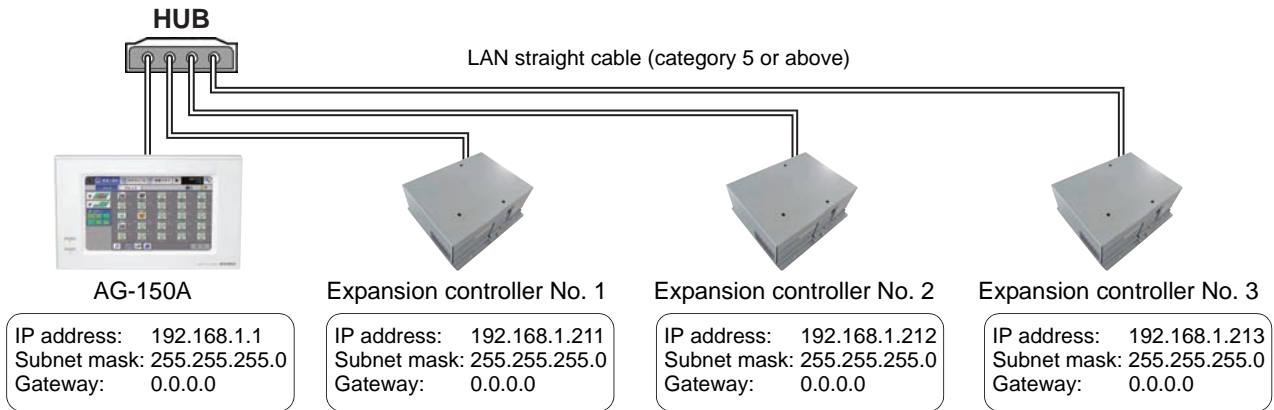

② Connecting to an existing LAN system

Consult the network administrator for how to set the IP address, subnet mask, and gateway address when connecting the expansion controller to an existing LAN.

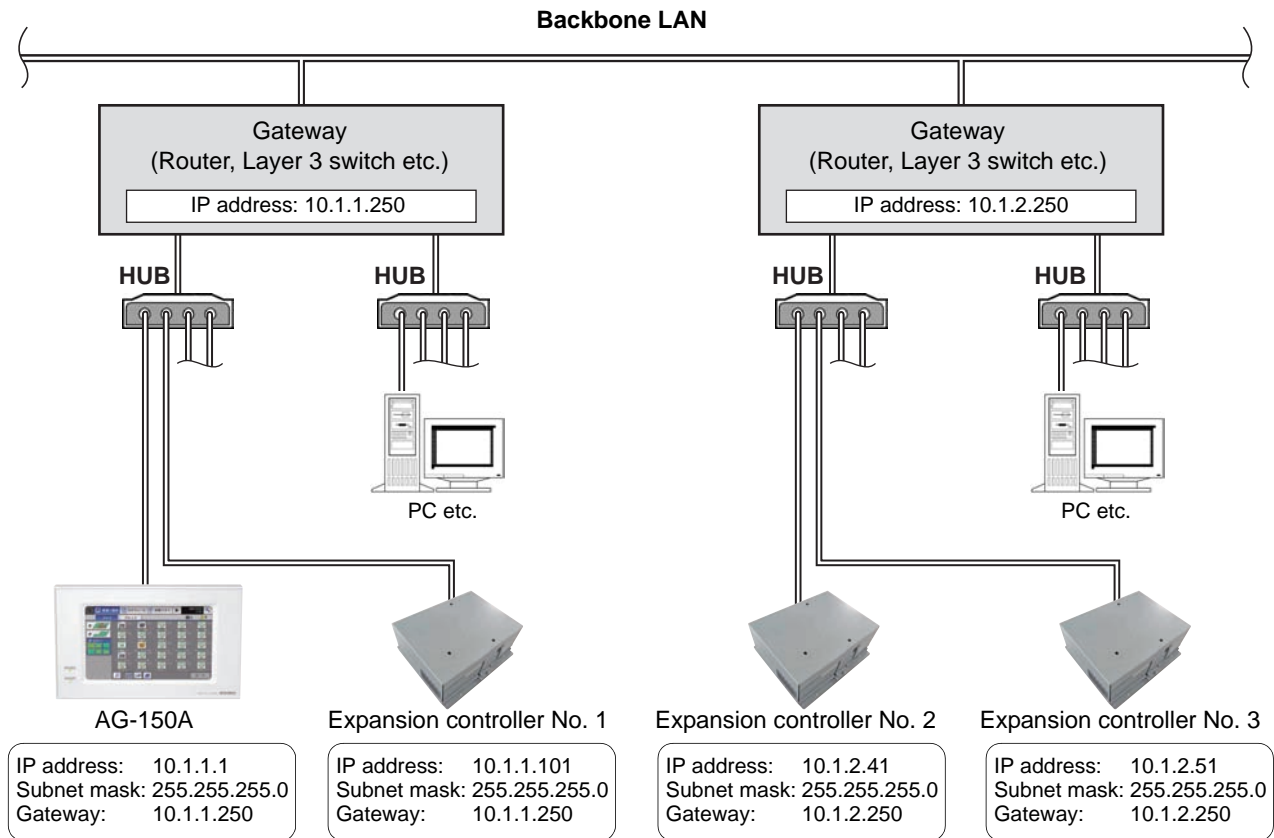

Important

- Install the LAN cable before installing the unit, and route the cable in the same way as the M-NET transmission lines.
- Consult the network administrator for how to set the IP address, subnet mask, and gateway address when connecting the expansion controller to an existing LAN. Use a router etc. between the existing LAN and the MITSUBISHI products so that they are not connected directly.
- Use the switching HUB.
- The recommended number of connected devices between AG-150A or other controllers and PAC-YG50ECA is four or less. Refer to section 4-4 "Connecting the LAN cable."

5-2. Function setting

5-2-1. Operation prohibit range setting (To be set from the AG-150A or other controllers)

Set this switch to prohibit operation from both the Sub system controller and remote controller OR only from the remote controller.

Setting	Function
SC·RC (Factory setting)	Operation from both the Sub controller and remote controller will be prohibited. * Normally, this setting should be selected.
RC Only	Operation only from the remote controller will be prohibited.

5-2-2. External input mode (To be set from the AG-150A or other controllers)

Set the external input mode.

Refer to section (8 | External input/output).

Setting	Function
Do not use (Factory setting)	External input signal will not be used.
Emergency Stop (Level signal)	Emergency stop/ Normal (level signal)
ON/OFF (Level signal)	Run/Stop (level signal)
ON/OFF/Prohibit/Permit (Pulse signal)	Run/Stop, Prohibit/Permit (pulse signal)

* The equipment connected to DIDO controller cannot be operated.

5-2-3. Prohibiting the connection of additional controllers such as AG-150A (SW603-4)

When a test run is completed and additional controllers such as AG-150A are not connected, set SW603-4 to ON. (Set the switch after the completion of a test run.)

Accidental connection of AG-150A that should be connected to other systems can be prevented by making the setting that disallows the connection of additional controllers, thus preventing negative impact on the operation of the air conditioners (unintended operation, abnormal stop etc.)

SW603-4	Function
OFF (Factory setting)	Allows connection of additional controllers such as AG-150A
ON (At the completion of a test run)	Disallows connection of controllers such as AG-150A whose IP address has never been connected

5-2-4. Deleting the error history (SW603-3) [Ver. 1.30 or later]

Delete (default) the error history data displayed on the 7-segment LED on the PAC-YG50ECA.

SW603-3	Function
The switch is set to ON from OFF.	Deletes (defaults) the error history data

5-2-5. Error display on the local remote controller when an EC line communication error ^(*1) occurs (SW604-7) [Ver. 1.30 or later]

When a communication error between PAC-YG50ECA and controllers such as AG-150A ^(*2) occurs, error (6607: No ACK error) can be displayed on the local remote controller.

When a local remote controller is not connected to indoor units, indoor units come to an abnormal stop.^(*3)

SW604-7	Function
OFF when power is turned on (Factory setting)	Errors are not displayed on the local remote controller when an EC line communication error occurs.
ON when power is turned on	An error (6607: No ACK error) is displayed on the local remote controller when an EC line communication error occurs. When a local remote controller is not connected to indoor units, indoor units come to an abnormal stop. ^(*3)

*1: EC line communication error is a communication error between PAC-YG50ECA (PAC-YG50EC) and controllers such as AG-150A.

*2: When connecting multiple AG-150A or other controllers, errors are displayed on the local remote controller only when the communication errors occur with all controllers. When a local remote controller is not connected to indoor units, indoor units come to an abnormal stop.^(*3)

*3: Indoor units will remain stopped after EC line communication error is restored. An abnormal stop status needs to be reset by stopping the indoor units.

Notes	<ul style="list-style-type: none"> ● Set SW604-7 before turning on the power. ● This function can be enabled only when "Do not use" is set in the external input mode for PAC-YG50ECA (Refer to section 5-2-2). When the setting other than "Do not use" is set in the external input mode, the following function is enabled regardless of SW604-7 setting. Function: Errors are not be displayed on the local remote controller when an EC line communication error occurs.
--------------	---

6 Test run

6-1. Batch operation/Stop (error reset) switches

- Before performing a test run, check that the group setting and interlock settings from the AG-150A and other controllers have been properly made.
- The batch operation function on the PAC-YG50ECA cannot be used to change the operation mode of the connected indoor units (including the test run mode). Units will be operated in the mode they are set to operate in. The PAC-YG50ECA does not have the function to automatically stop the test run in two hours as the remote controllers do.

<Setting procedures>

- ① Turn on all units and the PAC-YG50ECA.
- ② Set the switches as follows. SW601: All set to OFF; SW606: "0"; SW607: "0"
- ③ Check that LD5 on PAC-YG50ECA is unlit (SW601: All set to OFF; SW606: "0"; SW607 "0").
LD5 will be lit if the group setting and interlock setting from the AG-150A and other controllers have not been completed.
LD5 will blink while M-NET is starting up (takes approx. 10 minutes to complete).
- ④ Turn SW603-1 from the OFF position to the ON position. The operation signal will be sent to the groups that are registered.*¹
- ⑤ LD3 (SW601: All set to OFF; SW606: "0"; SW607 "0") will be lit when the units are in operation.
- ⑥ Check each unit for proper operation (e.g., supply air comes out of the indoor unit outlet.).
- ⑦ Turn SW603-2 from the OFF position to the ON position to bring the units to stop.
- ⑧ Turn SW603-1 and SW603-2 to OFF at the completion of the test run.

SW603	Function setting
1	Transmission of operation run signal to the registered groups (when turned ON from the OFF position)* ¹
2	Transmission of operation stop signal to the registered groups (when turned ON from the OFF position)* ¹

*¹ The equipment connected to DIDO controller cannot be operated.

6-2. Service LED display

PAC-YG50ECA has service LEDs to display the operation status.

LED No.	Item	Status	Notes	
LAN	LAN LINK ACT	Lit	Linking	
		Unlit	Not linked	
		Blink	Transmitting	
M-NET	M-NET	Lit	Powered	
		Unlit	Not powered	
		Blink	M-NET transmission in progress	
Error	Error status	Blink	At least one air conditioning unit is in error* ¹	
		Unlit	Normal	
7-segment LED	LD1	CPU status	Lit: Normal Unlit: Error	
	LD2	(Not assigned)	—	
	LD3	Operation status	Lit	At least one air conditioning unit is in operation.
			Unlit	All units are stopped.
	LD4	Error status	Lit	At least one air conditioning unit is in error* ¹
			Unlit	All units are normal.
	LD5	M-NET startup status	Lit	Group information not available
			Unlit	Complete
Blink			Starting up	
LD6	(Not assigned)	—	(Refer to section 10 (10) 7-segment LED for information on how other settings are displayed.)	
LD7	Number of connected AG-150A and other controllers	Number of connected AG-150A and other controllers (Numerical display)		
LD8				

*¹ The LED will not lit or blink for EC line errors.

7-segment LED

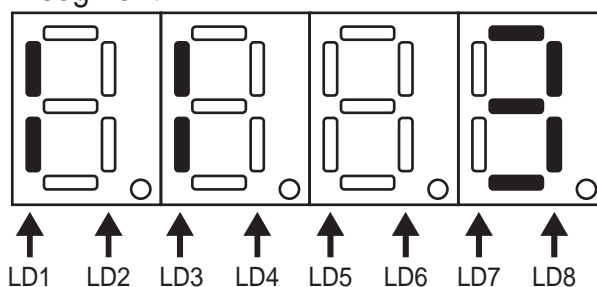

7 M-NET system setting example

① Connecting multiple M-NET system controllers

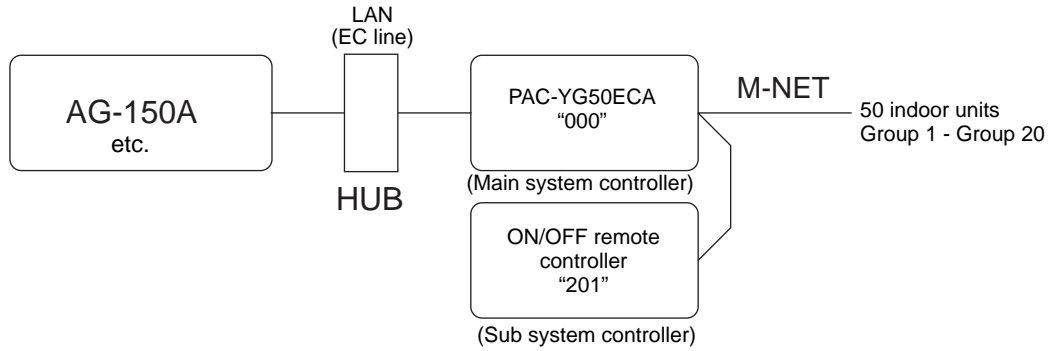

- Make the initial group and interlock settings from the AG-150A or other controllers.
- Designate a system controller within the system as the only controller from which operation prohibit setting can be made.

② Controlling Mr. Slim (A-control models)

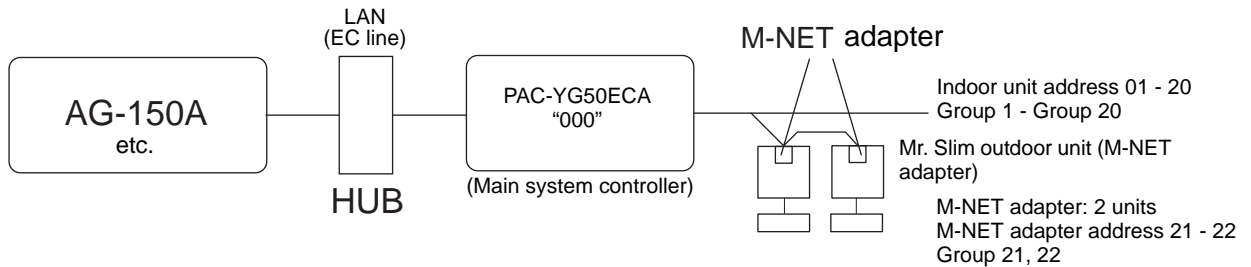

- An M-NET adapter (sold separately) is required to connect and control the Mr. Slim model of units to the M-NET.

③ Controlling the K-control models

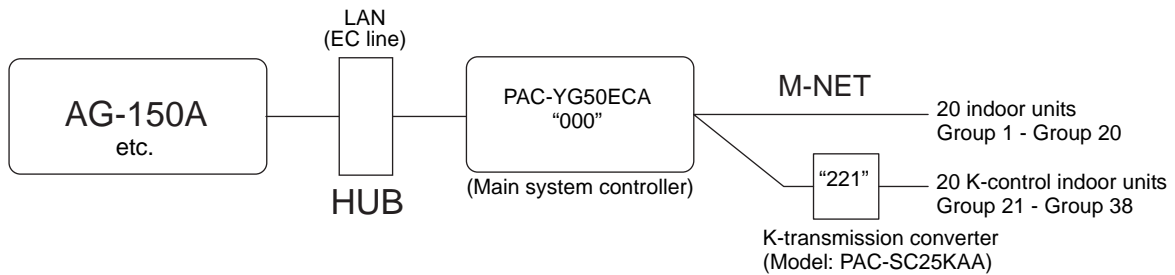

- Set the PAC-YG50ECA address to "000" when connecting a K-transmission converter.
- When making the group setting for K-control units, make the setting only for the indoor units that belong to a given group.
- The group number given to a group of K-control units should be the same as the lowest address of the indoor units that belong to the group.
- If the K-control Y series units and other types of units (K-control Mr. Slim) are used in combination, a relay board is required. The K-control Y series units cannot be connected to the same transmission lines as the other types of units.
- Depending on the number of K-control units and transmission line length, a relay board may be required. Refer to the System Design/Manual (control version) for details.
- LOSSNAY units cannot be connected if they are connected to the K-control kit.
- Remote controller addresses do not need to be included in the group setting for a group of K-control units.

8 External input/output

8-1. External signal input function

* To use the external signal input, a separately-sold external input/output adapter (PAC-YG10HA) is required.

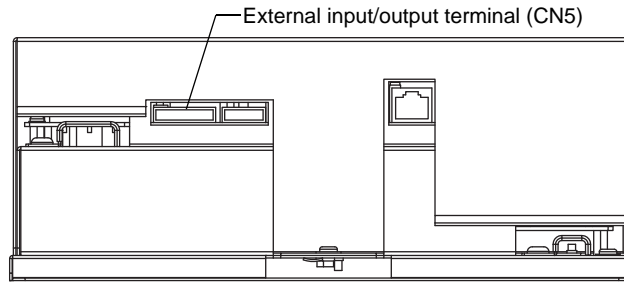

8-1-1. External input signal function setting (to be set from the AG-150A or other controllers)

External contact signal (12VDC or 24VDC) can be used to send signals indicating the following status of all air conditioning units that are controlled by the controller: Emergency stop/Normal, Run/Stop, and local remote controller operation Prohibit/Permit.

No.	External input signal function	Notes
1	External input signal will not be used. (factory setting)	—
2	Emergency stop/Normal (level signal)	During the emergency stop, the Run/Stop mode cannot be changed from the local remote controller, and the Run/Stop mode and Prohibit/Permit settings cannot be changed from the AG-150A or other controllers. Timer setting will be ignored.
3	Run/Stop (level signal)	The Run/Stop mode cannot be changed from the local remote controller, and the Run/Stop mode and Prohibit/Permit settings cannot be changed from the AG-150A or other controllers. Timer setting will be ignored.
4	Run/Stop, Prohibit/Permit (pulse signal)	The pulse width (contact ON) should be between 0.5 and 1 second.

* DIDO controller (PAC-YG66DC) cannot be collectively run or stopped by using the external input function. But when [Emergency stop/Normal (Level signal)] is selected, DIDO controller (PAC-YG66DC) can be collectively stopped by setting the appropriate switches on the DIDO controller.

8-1-2. Level signals and pulse signals

(A) Level signals

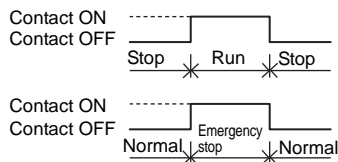

(B) Pulse signal

(Example) Run/Stop

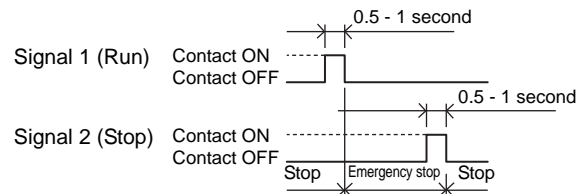

* Same with the Prohibit/Permit signal input.

8-1-3. External input specifications

CN5	Lead wire (PAC-YG10HA)	Emergency stop/Normal (level signal)	Run/Stop (level signal)	Run/Stop, Prohibit/Permit (pulse signal)
No. 5	Orange	Emergency stop/Normal signal input	Run/Stop signal input	Operation signal input
No. 6	Yellow	Not used	Not used	Stop signal input
No. 7	Blue	Not used	Not used	Local remote controller operation prohibit signal input
No. 8	Gray	Not used	Not used	Local remote controller operation permit signal input
No. 9	Red	External power supply 12VDC or 24VDC		

(A) Level signals

- ① If "Emergency stop/Normal operation signal" is selected, the unit will come to an emergency stop when the contact turns on, and the unit will resume normal operation when the contact turns off. When emergency stop is reset, all units will remain stopped, including the ones that were operating before the emergency stop signal input was received. To return to the previous operation status, these units need to be manually restarted.
- ② If "Run/Stop signal input" is selected, the unit will go into operation when external input signal contact turns ON, and the unit will stop when the contact signal turns OFF.

(B) Pulse signals

- ① If pulse signals to operate the units are received while the units are in operation, the units will continue their operation (same with the Stop, Prohibit, and Permit signals).
- ② When operation from the local remote controllers is prohibited, Run/Stop mode, operation mode, temperature setting, and filter reset settings cannot be changed from the local remote controller.
- ③ The pulse width (contact ON) should be between 0.5 and 1 second.

8-1-4. Recommended circuit

(A) Level signals

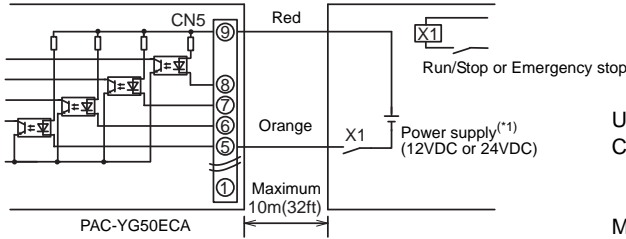

Use relays that meet the following specifications for X1, X2, Y1, and Y2.
Contact rating

Rated voltage: 12VDC or above

Rated current: 0.1 A or above

Minimum applied load: DC 1 mA or below

(*1) Use a power supply suitable for the type of relays used.
(12VDC or 24VDC)

(*2) Connect the DC power supply in the proper polarity.

If the connection is improper, the signal cannot be input or output.
Connect ① shown in the left figure to the negative side.

(B) Pulse signals

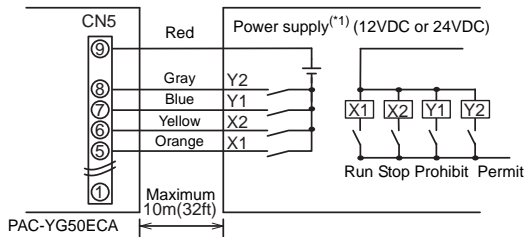

Important

- Be sure to use 12VDC or 24VDC for a power supply.
- Connect the power supply with correct polarity.
Improper connection may result in malfunctions.

- ① Relays, DC power supplies, and extension cables are field supplied.
- ② The maximum length of extension cable is 10 m (32 ft). (Use a cable with a diameter of at least 0.3 mm².)
- ③ Cut the excess cable near the connector, and insulate the exposed cable end with tape.

8-2. External signal output function

* A separately sold external input/output adapter (PAC-YG10HA) is required to use the external signal output.

8-2-1. External output

Operation signal is output when one or more units are in operation, and error signal is output when one or more units are in error^(*1).

*1: Error signal is not output when the AG-150A or other controllers are in error.

8-2-2. External output specification

CN5	Lead wire (PAC-YG10HA)	Terminal type
No. 1	Green	Common GND for external output (external DC, power supply GND)
No. 2	Black	Run/Stop*
No. 3	Brown	Error/Normal

* The operation status of DIDO controller is not output.

* Operation signal is output during an error.

8-2-3. Recommended circuit

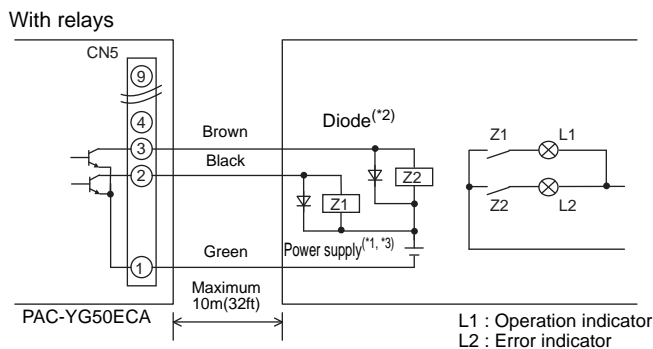

Use relays that meet the following specifications for Z1 and Z2.

Operation coil

Rated voltage: 12VDC or 24VDC

Power consumption: 0.9 W or less

(*1) Use a power supply suitable for the type of relays used.
(12VDC or 24VDC)

(*2) Use a diode at both ends of the relay coils.

(*3) Connect the DC power supply in the proper polarity.

If the connection is improper, the signal cannot be input or output.

Connect ① shown in the left figure to the negative side.

Important

- Be sure to use 12VDC or 24VDC for a power supply.
- Connect the power supply with correct polarity.
- Do not connect the power supply without relays being connected to the controller. (no load)
Improper connection may result in malfunctions.

- ① Each element turns on during operation and error.
- ② The maximum length of extension cable is 10 m (32 ft).
- ③ Relays, lamps, diodes, and extension cables are field supplied.

9 Detail setting switch setting method

IP address and other settings can be made with the detail setting switches on the PAC-YG50ECA.

NO	SW601 [0: OFF, 1: ON]								Setting items	Factory setting	Explanation	Notes		
	1	2	3	4	5	6	7	8						
16	0	0	0	1	0	0	0	0	IP address	a	192	IP address a.b.c.d (Factory setting: 192.168.1.211)	Set all SW602 to OFF. Reset the power after all settings have been made.	
17	0	0	0	1	0	0	0	1		b	168			
18	0	0	0	1	0	0	1	0		c	1			
19	0	0	0	1	0	0	1	1		d	211			
20	0	0	0	1	0	1	0	0	Subnet mask	a	255			Subnet mask a.b.c.d (Factory setting: 255.255.255.0)
21	0	0	0	1	0	1	0	1		b	255			
22	0	0	0	1	0	1	1	0		c	255			
23	0	0	0	1	0	1	1	1		d	0			
24	0	0	0	1	1	0	0	0	Gateway	a	0	Gateway address a.b.c.d (Factory setting: 0.0.0.0)		
25	0	0	0	1	1	0	0	1		b	0			
26	0	0	0	1	1	0	1	0		c	0			
27	0	0	0	1	1	0	1	1		d	0			
65	0	1	0	0	0	0	0	1	M-NET address		00	M-NET address 00, 201 to 250 (Factory setting: 00)	Reset the power after all settings have been made.	
250	1	1	1	1	1	0	1	0	Initial setting data Copy to USB memory		-	Set to SW606: "0"; SW607: "0" Copy the setting data to the ["EC_" + Serial Number] folder in the root folder of the USB memory.		
251	1	1	1	1	1	0	1	1	Initial setting data Read from USB memory		-	Set to SW606: "0"; SW607: "0" Read the setting data from USB memory. Create ["SetupData_" + IP address]*1 folder in the root folder of the USB memory using PC. Save the setting data in the folder. *1: When the IP address of PAC-YG50ECA is "192.168.1.211", the folder name will be [SetupData_192_168_1_211]. *2: Do not read the data that was saved from AG-150A or GB-50ADA.	Reset the power after all settings have been made.	

Note

- Use a USB memory that supports USB 1.1 standards. Some security-enhanced USB memories cannot be used. The following USB memories are checked for proper operation. (As of Oct. 2009)
- | | | |
|---------------------------|-------------------------|--------------|
| a: Manufacturer: Sandisk | Model: SDCZ6-2048-J65RB | Capacity: 2G |
| b: Manufacturer: Kingston | Model: DT400/2GBFE | Capacity: 2G |
| c: Manufacturer: I-O DATA | Model: TB-BH2/2G/* | Capacity: 2G |
| d: Manufacturer: I-O DATA | Model: TB-BH2/4G/* | Capacity: 4G |
| e: Manufacturer: BUFFALO | Model: RUF-C2GS-*/U2 | Capacity: 2G |
| f: Manufacturer: BUFFALO | Model: RUF2-C2GS-*/M | Capacity: 2G |
| g: Manufacturer: BUFFALO | Model: RUF-C4GS-*/U2 | Capacity: 4G |
| h: Manufacturer: BUFFALO | Model: RUF-C8GS-*/U2 | Capacity: 8G |
| i: Manufacturer: adata | Model: C702 | Capacity: 2G |
- (* or ** in the models of c through h indicates color.)

* Use FAT32 or FAT16 to format a USB memory if necessary.

9-1. Switch setting

How to set the switches is explained below, using an example of how to set No. 16 "IP address a" to "197 (C5 in hexadecimal notation)."

Use hexadecimal notation to set the values using switches SW606 (upper digit) and SW607 (lower digit).

The LED display is in decimal notation.

Steps	Setting item	Setting method	7-segment LED display
1	Select the item No.	Set SW601 to [0001 0000].	[_ 016] will appear for one second, and the SW606 and SW607 preset values will appear.
2	Enter a value.	Set SW606 (upper digit) to "C", and SW607 (lower digit) to "5".	[197]
3	Save the setting.	Press and hold SW605 for three seconds.	[End] will appears after [197] blinks. Reset the setting when [Err_] is displayed.

Important	<ul style="list-style-type: none"> Refer to section 10-1 "7-segment LED display and switch settings," and check that the switches are set correctly.
------------------	---

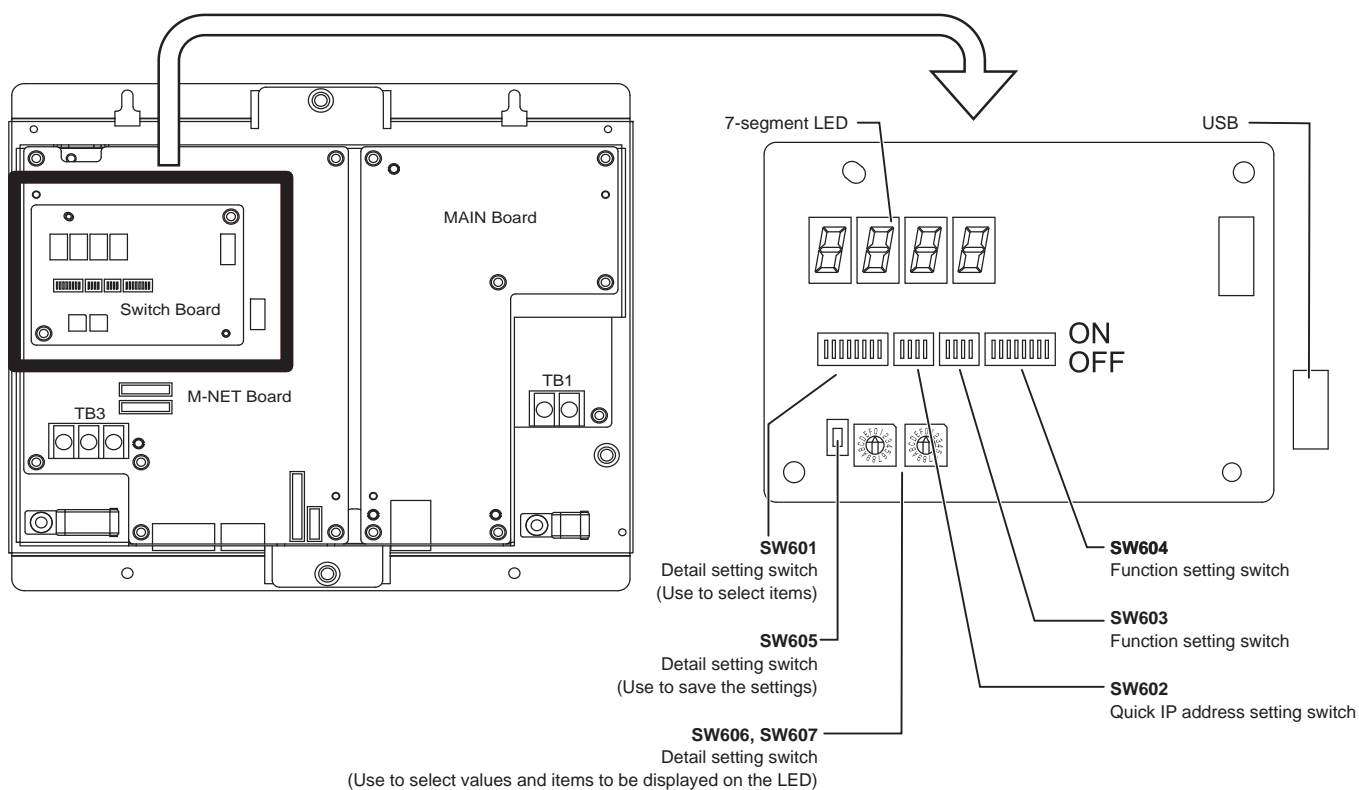

10 7-segment LED

The settings for switches SW601, SW606, and SW607 on the PAC-YG50ECA can be verified on the 7-segment LED.

- Numerical display
(Example: 18.8)

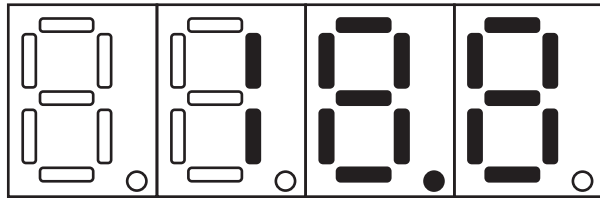

- Flag display
(Example: LD1, LD2, LD5, and LD7 are on.)

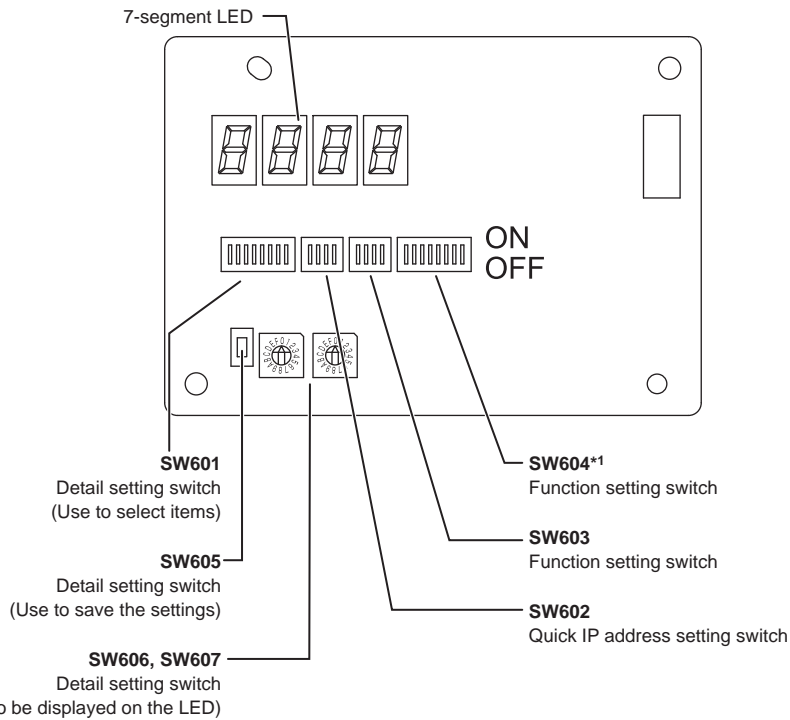
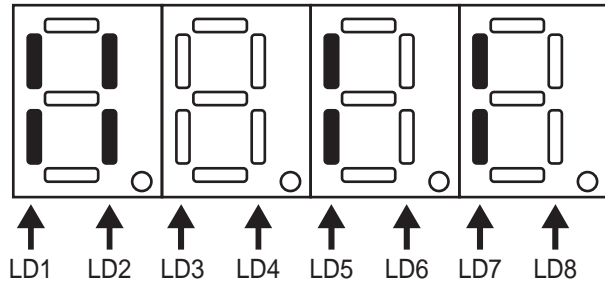

<Bringing up the DB No. on the 7-segment LED on the expansion controller>

On the switch board, set SW601 to "All OFF", SW606 to "2," and SW607 to "5."

The DB No. will appear on the 7-segment LED on the expansion controller.

Refer to the following pages for other displays and switch settings.

*1: Set all switches other than SW604-7 (refer to 5-2-5) to OFF (factory setting).

10-1. 7-segment LED display and switch settings

SW601 1234 5678	SW606	SW607	Item	Display								Notes	
				LD1	LD2	LD3	LD4	LD5	LD6	LD7	LD8		
0000 0000	0	0	Expansion controller status	CPU status		Normal operation	Error	Starting up		Number of connected controllers	Refer to section 6 "Test run."		
0: OFF 1: ON	0	1	Error detection	[Error code] and [Error source address] appear alternately. The latest error appears if multiple errors have occurred.								[---] appears when there are no errors.	
	1	0	IP address	a	IP address a.b.c.d								
	1	1		b									
	1	2		c									
	1	3		d									
	1	4	Subnet mask	a	Subnet mask a.b.c.d								
	1	5		b									
	1	6		c									
	1	7		d									
	1	8	Gateway	a	Gateway address a.b.c.d								
	1	9		b									
	1	A		c									
	1	B		d									
	1	C	MAC address	a	MAC address a-d-c-d-e-f								
	1	D		b									
	1	E		c									
	1	F		d									
	2	0		e									
	2	1		f									
	2	2	M-NET address	000, 201 ~ 250									
2	3	S/W version	00.00 ~ 99.99										
2	5	DB number	00 ~ 99										
2	6	Current date	Year	[Year]									
2	7		Month: Date	[Month: Date]									
2	9		Hour: Minute	[Hour: Minute]									
2	A		Second	[Second]									
3	C	Serial number	ab	Serial number abcd-efg									Appears only when S/W version is Ver. 1.10 or later.
3	D		cd										
3	E		efg										
9	0	AG-150A or other controllers connection status				Controller 5	Controller 4	Controller 3	Controller 2	Controller 1	No connection: unlit Connecting: Top and bottom indicators are lit. Waiting for connection: Bottom indicator is lit.		
B	0	AG-150A or other controllers 1 IP address	a	IP address a.b.c.d									
B	1		b										
B	2		c										
B	3		d										
B	4	AG-150A or other controllers 2 IP address	a	IP address a.b.c.d									
B	5		b										
B	6		c										
B	7		d										
B	8	AG-150A or other controllers 3 IP address	a	IP address a.b.c.d									
B	9		b										
B	A		c										
B	B		d										
B	C	AG-150A or other controllers 4 IP address	a	IP address a.b.c.d									
B	D		b										
B	E		c										
B	F		d										
C	0	AG-150A or other controllers 5 IP address	a	IP address a.b.c.d									
C	1		b										
C	2		c										
C	3		d										

SW601 1234 5678	SW606	SW607	Item	Display								Notes		
				LD1	LD2	LD3	LD4	LD5	LD6	LD7	LD8			
0000 0001 0: OFF 1: ON	0	0	Error history M-NET	1 Latest	[Error code] and [Error source address] appear alternately every second.								Error history of air conditioners (M-NET)	
	0	1		2										
	0	2		3										
	~			ι										
	3	E		63										
	3	F		64										
0000 0010 0: OFF 1: ON	0	0	Date of error detection (year, month, date) M-NET	1 Latest	[year, month] and [date] will appear alternately every second.									Error history of the AG-150A
	0	1		2										
	0	2		3										
	~			ι										
	3	E		63										
	3	F		64										
	0000 0010 0: OFF 1: ON	4	0	Time of error detection (hour, minute) M-NET	1 Latest	[hour, minute]								
		4	1		2									
		4	2		3									
		~			ι									
		7	E		63									
		7	F		64									
0000 0001 0: OFF 1: ON	8	0	EC line error history ^{*1}	1 Latest	[Error code] and [(No. of the controller)] appear alternately every second.									
	8	1		2										
	8	2		3										
	~			ι										
	B	E		63										
	B	F		64										
0000 0010 0: OFF 1: ON	8	0	Date of EC line error detection (year, month, date) ^{*1}	1 Latest	[year, month] and [date] will appear alternately every second.									
	8	1		2										
	8	2		3										
	~			ι										
	B	E		63										
	B	F		64										
	0000 0010 0: OFF 1: ON	C	0	Time of EC line error detection (hour, minute, second) ^{*1}	1 Latest	[hour, minute] and [second] appear alternately every second.								
		C	1		2									
		C	2		3									
		~			ι									
		F	E		63									
		F	F		64									

*1 EC line error: Communication error between the AG-150A etc. and expansion controller (PAC-YG50ECA)

11 Error code list

Notes

- The list below contains all error codes. Some of these error codes may not be applicable to the system to which the PAC-YG50ECA is connected.

11-1. M-NET error code

The following is a list of the error codes and their meaning. (A) indicates A-control units

0100	"Blanket unit error"
01*0	"Equipment abnormality **"
0403	"Serial transmission trouble"
0404	Indoor unit EEPROM abnormality (A)
0701	Combustion circuit abnormality (A)
0702	Overheat protection for the combustion heat exchanger (A)
0703	Accidental fire (A)
0704	Heater abnormality (A)
0705	Seismoscope malfunction (A)
0706	Flame current sensor abnormality (A)
0707	Ignition problem (A)
0708	Blower motor rotational speed abnormality (A)
0709	Oil pump circuit abnormality (A)
0900	"Test run"
1000	"Ref.cycle abnormality"
10*0	"Ref.cycle abnormality in line **"
1102	Discharge temperature abnormality (TH4) (A)
1108	Inner thermo (49C) trip (A)
11**	"Ref.cycle temperature abnormality - Common operand: ***"
12**	"Ref.cycle temperature abnormality allowance - Common operand: ***"
1300	Low pressure abnormality (63L trip) (A)
13**	"Ref.cycle pressure abnormality - Common operand: ***"
14**	"Ref.cycle pressure abnormality allowance - Common operand: ***"
1500	"Ref.cycle not operate due to overcharge"
1501	"Ref.cycle not operate due to undercharge" (/compressor shell temperature abnormality)
1502	"Ref.cycle not operate due to liquid back" /Low pressure abnormality (63L trip) (A)
1503	"Ref.cycle not operate due to coil frost"
1504	"Ref.cycle not operate due to overheat protection"
1505	"Ref.cycle not operate due to compressor vacuum operation protection/refrigerant low temperature abnormality"
1506	"Ref.cycle not operate due to refrigerant pump abnormality"
1507	"Ref.cycle not operate due to composition detection abnormality"
1508	"Ref.cycle not operate due to control valve fault"
1509	"Ref.cycle not operate due to high pressure abnormality (ball valve closed) "
1510	"Ref. cycle gas leakage"
1511	"Ref.cycle not operate due to oil slick abnormality"
1512	"Ref.cycle not operate due to a stop of freezing protection function"
1513	"Ref.cycle brine freezing"
1559	"Oil balance circuit abnormality"
1600	"Ref.cycle - Preliminary overcharge refrigerant trouble"
1601	"Ref.cycle - Preliminary lacked refrigerant trouble"
1605	"Ref.cycle - Preliminary suction operation protection"
1606	"Ref.cycle - Preliminary gas pump abnormality"
1607	"Ref.cycle - Preliminary CS circuit closed detection abnormality"
1608	"Ref.cycle - Preliminary control valve abnormality"
1659	"Ref.cycle - Preliminary oil balance circuit abnormality"
2000	"Water system abnormality" (Pump interlock abnormality)
20*0	"Water system abnormality in line **"
21**	"Water system temperature abnormality - Common operand: ***"
22**	"Water system temperature abnormality allowance - Common operand: ***"
23**	"Water system pressure abnormality - Common operand: ***"
24**	"Water system pressure abnormality allowance - Common operand: ***"

2500 "Water system not operate due to water leak"

2501 "Water system not operate due to water supply suspension"

2502 "Water system not operate due to drain pump abnormality"

2503 "Water system not operate due to drain sensor abnormality/float switch function"

2504 "Water system not operate due to liquid level abnormality"

2505 "Water system not operate due to cool water valve abnormality"

2506 "Water system not operate due to warm water valve abnormality"

2507 "Water system not operate due to dew condensation prevention control activated"

2600 "Water system operation restricted due to water leak"

2601 "Water system operation restricted due to water supply suspension/humidifier water supply suspension"

2602 "Water system operation restricted due to drain pump abnormality"

2603 "Water system operation restricted due to drain sensor abnormality"

2604 "Water system operation restricted due to liquid level abnormality"

3152 "Air system operation restricted due to inverter control box inner temperature abnormality"

3182 "Air system operation restricted due to housing inner temperature abnormality"

3252 "Air system operation restricted due to preliminary control box temperature abnormality"

3600 "Air system operation restricted due to filter clogging"

3601 "Air system operation restricted due to filter maintenance"

3602 "Air system operation restricted due to damper position detecting abnormality"

37** "Air system operation humidity abnormality allowance - Common operand: **"

38** "Air system operation humidity abnormality - Common operand: **"

4000 "Electric system abnormality"

40*0 "Electric system abnormality in line **"

4100 "Electric system not operate due to overcurrent shut-off"

4101 "Electric system not operate due to overcurrent protection"

4102 "Electric system not operate due to open phase" /Open phase (T phase), (A)

4103 "Electric system not operate due to reversed phase/open phase"

4104 "Electric system not operate due to electric leak"

4105 "Electric system not operate due to short circuit"

4106 "Electric system not operate due to self power supply OFF/power failure"

4107 "Electric system not operate due to overlord"

4108 "Electric system not operate due to overlord protection/OCR51C" /Open phase (S phase), Open connector 51CM(A)

4109 "Electric system not operate due to OCR51F"

4110 "Electric system not operate due to high voltage part"

4111 "Electric system not operate due to bus current"

4112 "Electric system not operate due to coil overheat 49°C"

4113 "Electric system not operate due to heater overheat"

4114 "Electric system not operate due to fan controller abnormality"

4115 "Electric system not operate due to power supply synchronism abnormality" /Input circuit (circuit board) defect

4116 "Electric system not operate due to motor abnormality/speed abnormality"

4117 Compressor self-protection function trip (A)

4118 Reversed phase detection circuit (circuit board) problem (A)

4119 More than 2 connectors are open.(A)

4121 "Electric system not operate due to trouble in equipment to which a measure against higher harmonics is taken"

4123 "Electric system not operate due to Inverter output error"

4124 "Electric system not operate due to damper abnormality"

4125 "Electric system - Rush-proof circuit abnormality"

4126 "Electric system - Preliminary overcurrent protection/OCR51C"

4162 "Electric system not operate due to compressor coil temperature abnormality delay"

4163 "Electric system not operate due to preliminary fan controller abnormality"

4165 "Electric system not operate due to preliminary power synchronization error"

4171 "Electric system - Preliminary trouble in equipment to which a measure against higher harmonics is taken"

4200 "Inverter abnormality"

420* "Inverter abnormality - Inverter No.: **"

4210 "Inverter overcurrent shut-off"

421* "Inverter overcurrent shut-off - Inverter No.: **"

4220 "Inverter bus voltage insufficiency" / Voltage abnormality (A)

422* "Inverter bus voltage insufficiency - Inverter No.: **"

4230 "Inverter radiating thermostat abnormality"

423* "Inverter radiating thermostat abnormality - Inverter No.: **"

4240 "Inverter overcurrent (overload) protection"

424* "Inverter overcurrent protection - Inverter No.: **"

4250 "Inverter IPM/bus voltage abnormality" /Power module abnormality (A)

425* "Inverter IPM abnormality **"

4260 "Inverter cooling fan trouble"

426* "Inverter cooling fan trouble - Inverter No.: **"

4300 "Inverter abnormality allowance"

430* "Inverter abnormality allowance - Inverter No.: **"

4310 "Inverter overcurrent shut-off allowance"

431* "Inverter overcurrent shut-off allowance - Inverter No.: **"

4320 "Inverter bus voltage insufficiency allowance"

432* "Inverter bus voltage insufficiency - Inverter No.: **"

4330 "Inverter radiating thermostat abnormality allowance"

433* "Inverter radiating thermostat abnormality allowance - Inverter No.: **"

4340 "Inverter overcurrent protection abnormality"

434* "Inverter overcurrent protection abnormality - Inverter No.: **"

4350 "Inverter IPM abnormality allowance"

435* "Inverter IPM abnormality allowance **"

4360 "Inverter preliminary cooling fan trouble"

436* "Inverter preliminary cooling fan trouble - Inverter No.: **"

5000 "Sensor trouble"

50*0 "Sensor trouble in system **"

51** "Temperature sensor trouble - Sensor No.: ***"

5202 Open connector (63L) (A)

52** "Pressure sensor trouble - Sensor No.: ***"

5300 Current sensor abnormality (A)

53** "Current sensor trouble - Sensor No.: ***"

54** "Humidity sensor trouble - Sensor No.: ***"

55** "Gas sensor trouble - Sensor No.: **"

56** "Air speed sensor trouble - Sensor No.: ***"

57** "Limit switch trouble - Switch No.: ***"

58** "Sensor trouble - Sensor No.: ***"

59** "Other sensors trouble - Sensor No.: ***"

6000 "System abnormality"

6101 "System not operate due to abnormality - With response frame"

6102 "No answer back"

6200 "Controller H/W abnormality"

6201 "E2PROM abnormality"

6202 "RTC abnormality"

6500 "Communication error"

6600 "Communication error - Address duplicate"

6601 "Communication error - Polarity unsettled"

6602 "Communication error - Transmission processor hardware error"

6603 "Communication error - Transmission line busy"

6604 "Communication error - No ACK (06H) (communication circuit error)"

6605 "Communication error - No response frame"

6606 "Communication error - Transmission processor communication error"

6607 "Communication error - No ACK return"

6608 "Communication error - No return of response frame"

6609 "Communication error"

6610 "Communication error"

6700 "Communication error - K-transmission abnormality"

6701 "Communication error - K-transmission error"

6702 "Communication error - K-address duplicate"

6750 "Communication error - K abnormality code PO"

6751 "K abnormality - Room temperature thermistor abnormality"

6752 "K abnormality - Indoor coil thermistor abnormality, Condensation temperature sensor abnormality"

6753 "K abnormality - Transmit/receive error"

6754 "K abnormality - Drain sensor abnormality, Float switch function"

6755 "K abnormality - Drain pump abnormality"

6756 "K abnormality - Coil frost/overheat protection"

6757 "K abnormality - System error"

6758 "K abnormality - Outdoor unit trouble, Indoor/outdoor communication error"

6761 "K abnormality - Room temperature thermistor abnormality"

6762 "K abnormality - Indoor coil thermistor abnormality, Condensation temperature sensor abnormality"

6763 "K abnormality - Transmit/receive error"

6764 "K abnormality - Drain sensor abnormality"

6765 "K abnormality - Drain pump abnormality"

6766 "K abnormality - Coil frost/overheat protection"

6767 "K abnormality - Outdoor unit trouble - Indoor/outdoor communication error"

6771 "K abnormality - High pressure abnormality, Low pressure abnormality"

6772 "K abnormality - Inner thermostat function, Discharge temperature abnormality, Shell thermostat function, Overcurrent protection"

6773 "K abnormality - Radiator plate thermostat function"

6774 "K abnormality - Outdoor thermistor abnormality"

6775 "K abnormality - Pressure sensor abnormality, Indoor/outdoor communication error"

6776 "K abnormality - Overcurrent shut-off"

6777 "K abnormality - System error"

6778 "K abnormality - Normal"

6779 "K abnormality - Refrigerant overcharge, Abnormal voltage, Abnormal CT sensor"

6800 "Communication error - Other communication errors"

6801 "Communication error - V-control communication error"

6810 "Communication error - UR communication error"

6811 "Communication error - UR communication synchronism not recover"

6812 "Communication error - UR communication hardware error"

6813 "Communication error - UR communication status bit detection error"

6820 "Other communication errors"

6821 "Other communication errors - Transmission line busy"

6822 "Other communication errors - No communication ACK"

6823 "Other communication errors - No response command"

6824 "Other communication errors - Receive data error"

6830 "Communication error - MA communication refrigerant address double setting error"

6831 "Communication error - No MA communication reception error"

6832 "Communication error - MA communication synchronism not recover"

6833 "Communication error - MA communication transmission/reception hardware trouble"

6834 "Communication error - MA communication start bit detection error"

6840 "Communication error - A control no indoor/outdoor communication/reception abnormality"

6841 "Communication error - A control indoor/outdoor communication synchronization recovery abnormal"

6844 "A control indoor/outdoor communication incorrect indoor/outdoor wiring connection, excessive number of indoor units (more than five units)"

6845 "Communication error - A control indoor/outdoor communication incorrect indoor/outdoor wiring connection (telecommunication, disconnection)"

6846 "Communication error - A control indoor/outdoor communication startup time exceeded"

7000 "System abnormality"

7100 "System abnormality - Total capacity error"

7101 "System abnormality - Capacity code error"

7102 "System abnormality - Connecting unit number excess"

7103 "System abnormality - Piping length setting error"

7104 "System abnormality - Floor height setting error"

7105 "System abnormality - Address setting over 254"

7106 "System abnormality - Attribute setting error"

7107 "System abnormality - Distributor setting error"

7108 "System abnormality - Ref. system setting error"

7109 "System abnormality - Connection setting error"

7110 "System abnormality - Ref. system connection/connection data unsettled"

7111 "System abnormality - I/O connection equipment not connected/remote controller sensor abnormality"

7112 "System abnormality - I/O type setting error"

7113 "System abnormality - Equipment unsettled"

7116	"System abnormality - Replace non-wash setting error"
7117	"System abnormality- Model identification setting error"
7130	"System abnormality - Different unit model error"
7131	"System abnormality- Mixed cooling only H/P connection error (Facility PAC)"
7132	"System abnormality - Multiple entries of operation performance (Facility PAC)"
7200	"System abnormality - Numeric values unsettled"
7201	"System abnormality - Numeric values unsettled"
73**	"System abnormality - LON-system equipment abnormality"

11-2. EC line error code *1

[6920]	No response error
[6922]	Response ID error
[7901]	Maximum connectable No. of units exceeded
[7902]	Connection lock error
[7903]	Unit information error
[7904]	System setting error
[7905]	Version error

*1 EC line error: Error between the AG-150A etc. and Expansion Controller (PAC-YG50ECA)

NOTE:

This equipment has been tested and found to comply with the limits for a Class B digital device, pursuant to Part 15 of the FCC Rules. These limits are designed to provide reasonable protection against harmful interference in a residential installation. This equipment generates, uses and can radiate radio frequency energy and, if not installed and used in accordance with the instructions, may cause harmful interference to radio communications.

However, there is no guarantee that interference will not occur in a particular installation.

If this equipment does cause harmful interference to radio or television reception, which can be determined by turning the equipment off and on, the user is encouraged to try to correct the interference by one or more of the following measures:

- Reorient or relocate the receiving antenna.
- Increase the separation between the equipment and receiver.
- Connect the equipment into an outlet on a circuit different from that to which the receiver is connected.
- Consult the dealer or an experienced radio / TV technician for help.

This product is designed and intended for use in the residential,
commercial and light-industrial environment.

The product at hand is
based on the following
EU regulations:

- Low Voltage Directive 2006/95/EC
- Electromagnetic Compatibility Directive,
2004/108/EC

Please be sure to put the contact address/telephone number on
this manual before handing it to the customer.

 **MITSUBISHI ELECTRIC CORPORATION**

HEAD OFFICE: TOKYO BLDG. , 2-7-3, MARUNOUCHI, CHIYODA-KU, TOKYO 100-8310, JAPAN

Authorized representative in EU: MITSUBISHI ELECTRIC EUROPE B.V.

HARMAN HOUSE, 1 GEORGE STREET, UXBRIDGE, MIDDLESEX UB8 1QQ, U.K.

WT05578X05
Printed in Japan