

Changes for the Better

Model AG-150A
PAC-SC51KUA

DATA BOOK

CITY MULTI CONTROLLER

1. System remote controller.....	Cntr-2
1-1. Centralized controller [AG-150A].....	Cntr-2
1-2. Power supply unit [PAC-SC51KUA].....	Cntr-10
1-3. Integrated centralized control software [TG-2000A].....	Cntr-13

1. System remote controller

1-1. Centralized controller [AG-150A]



■ Functions

□:Each unit ○:Each group ●:Each block
 △:Each floor ◎:Collective ×:Not available

Item	Description	Operations	Display
ON/OFF	Run and stop operation for the air conditioner units	○◎△●	○◎
Operation mode switching	Switches between Cool / Dry / Auto / Fan / Heat. (Group of LOSSNAY unit : automatic ventilation/ vent - heat interchange/ normal ventilation) Operation modes vary depending on the air conditioner unit. Auto mode is the City Multi R2 and WR2 series only.	○◎△●	○
Temperature setting	Range of temperature setting Cool/Dry : 19°C - 30°C (14°C - 30°C) / 67°F - 87°F (57°F - 87°F) Heat : 17°C - 28°C (17°C - 28°C) / 63°F - 83°F (63°F - 83°F) Auto : 19°C - 28°C (17°C - 28°C) / 67°F - 83°F (63°F - 83°F) () when using middle-temperature on PEFY-VMS/VMH by setting DipSW7-1 to ON. Yet, PEFY-P-VMH-E-F is excluded. * Range of temperature settings vary depending on model.	○◎△●	○
Fan speed setting	Models with 5 air flow speed settings: Hi/Mid-2/Mid-1/Low, Auto Models with 4 air flow speed settings: Hi/Mid/Low, Auto Models with 2 air flow speed settings: Hi/Low Fan speed setting (including Auto) varies depending on the model.	○◎△●	○
Air flow direction setting	Air flow direction angles, 4-angle or 5-angle Swing, Auto *1: Louver cannot be set. *Air flow direction settings vary depending on the model.	*1 ○◎△●	○
Schedule operation	Weekly schedule can be set for each group of air conditioning units. *2 By registering a license for AG-150A, weekly (2 types), annual, and current day scheduling function become available. The system follows either the current day, annual schedule, or weekly, which are in the descending order of overriding priority. Twenty-four events can be scheduled per day, including Start/Stop, Mode, Temperature Setting, Operation Prohibition, Vane Direction, and Fan Speed. Two types of weekly schedule (Summer/Winter) can be set. Settable items depend on the functions that a given air conditioning unit supports.	*2 ○◎△●	○
Permit / Prohibit local operation	Individually prohibit operation of each local remote control function (Start/Stop, Change operation mode, Set temperature, Reset filter). *3: When the local remote controller inactivation command is received from the master system controller, "Disabled" appears in inverted display on the operation setting screen.	○◎△●	*3 ○
Indoor unit intake temperature	Measures the intake temperature of the indoor unit only when the indoor unit is operating.	×	○
Error	When an error is currently occurring on an air conditioner unit, the afflicted unit and the error code are displayed. *4: When an error occurs, the "ON/OFF" LED flashes. The operation monitor screen shows the abnormal unit by flashing it. The error monitor screen shows the abnormal unit address, error code and source of detection. The error log monitor screen shows the time and date, the abnormal unit address, error code and source of detection.	×	*4 □◎
Test run	This operates air conditioner units in test run mode.	○◎△●	○
Ventilation equipment	The interlocked system settings can be performed by the master system controller. When setting the interlocked system, you can use the ventilation switch to switch the free plan LOSSNAY settings between "Hi", "Low" and "Stop". When setting a group of only free plan LOSSNAY units, you can switch between "Normal ventilation", "Interchange ventilation" and "Automatic ventilation".	○◎△●	○
External input/output	By using accessory cables you can set and monitor the following. Input: By level signal: "Batch start/stop", "Batch emergency stop" By pulse signal: "Batch start/stop", "Enable/disable local remote controller" Output: "Start/stop", "Error/Normal" *5: Requires the external I/O cable (PAC-YG10HA) sold separately.	◎*5	◎*5

A. The centralized controller of AG-150A combines Web function (optional), which enable the air conditioner system management on a PC browser screen. *1 The management even carried out at a long distance place via public telephone line or internet.

*1 Microsoft® Internet explorer Ver. 6 or later by Microsoft Corporation is needed. (Note: You must have "Sun Microsystems Java".)
Microsoft® Internet explorer is a registered trade mark of Microsoft Corporation US in the USA and other countries.

Note: Connect AG-150A to a private network.

Use a security device such as a VPN router when connecting the AG-150A to the Internet to prevent unauthorized access.

B. Together with integrated centralized control software TG-2000A, and/or PLC, many optional functions like "Charging", "Peak-cut", "Energy saving", "General equipment management", "Scheduling" etc, can be carried out. Details, please refer to sections of TG-2000A and PLC software.

C. One AG-150A can control maximum 50 Indoor units (including LOSSNAY). The integrated centralized control software TG-2000A can manage maximum 40 AG-150As, therefore can manage maximum 2000 Indoor units (including LOSSNAY).

D. Taking advantage of AG-150A's Web functions, alarming E-mail containing address and error code can be sent to appointed E-mail address upon any fault happen at the air conditioner system. This could release standby personnel and save operation cost.

E. AG-150A features a 9"-wide color LCD touch panel. The settings for air conditioning units can be changed by touching the corresponding icons on the display.

■ External dimension

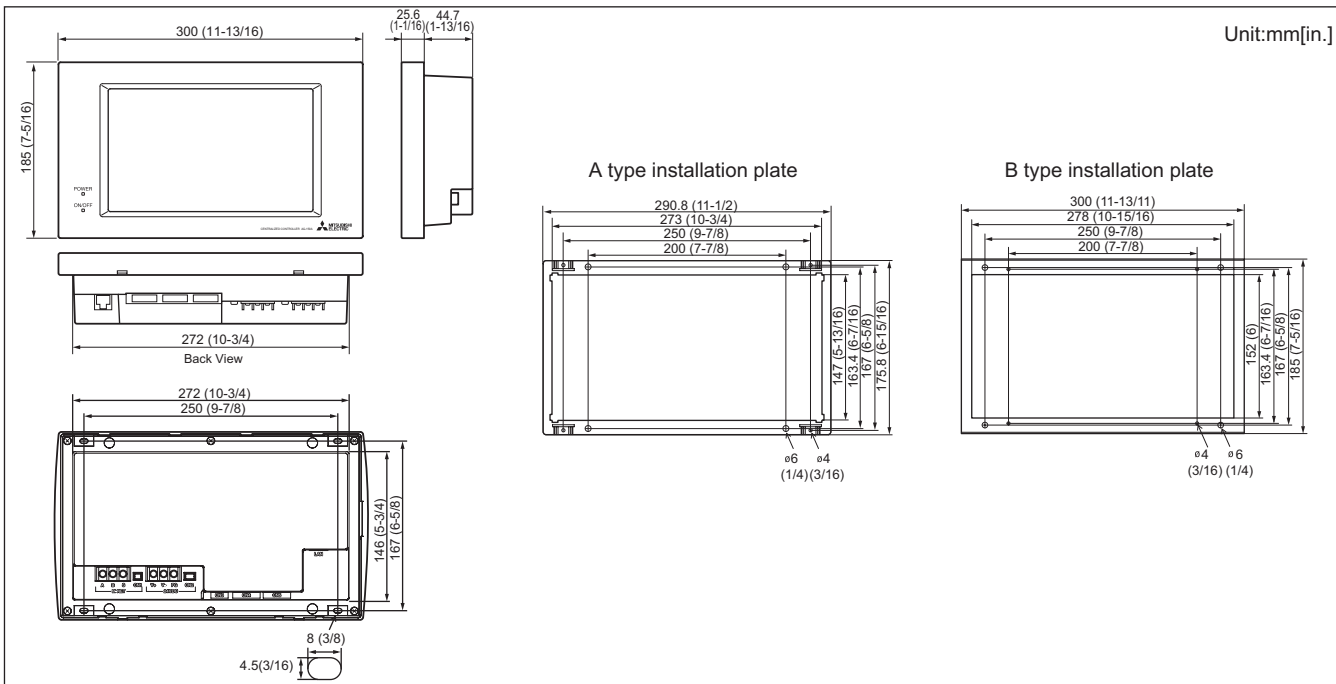

1. System remote controller

1. Power supply to AG-150A

AG-150A needs DC power supply of M-NET (24~32V) and 24V; the former is for centralized control transmission use and the latter is for AG-150A's operating and LAN function use. AG-150A can have power-supply at following 1,2 methods.

- (1). Power supply unit PAC-SC51KUA is the recommended power supplier for AG-150A. The basic scheme is as follows. For details, please refer to Power supply unit PAC-SC51KUA.

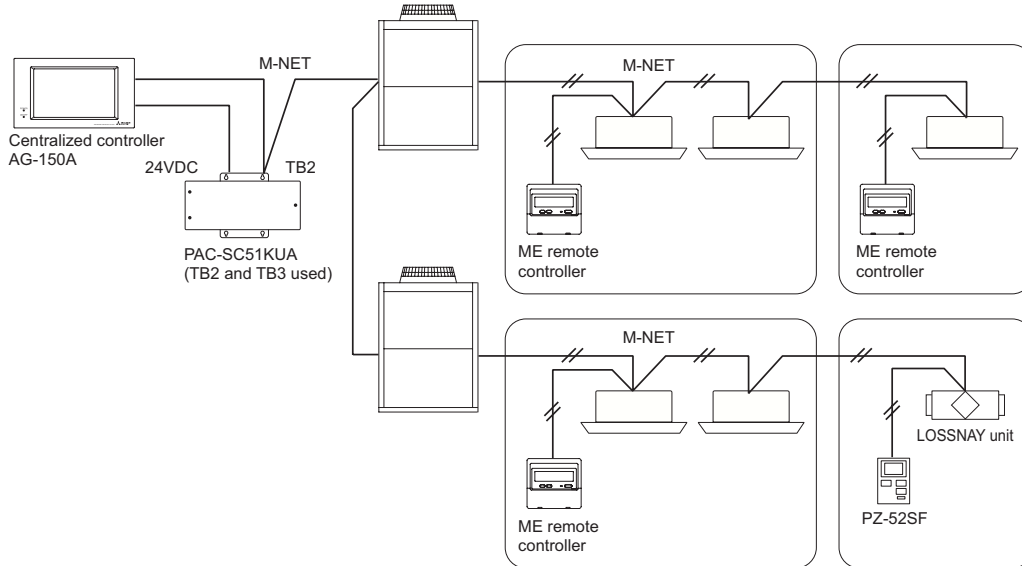

Fig. 1 AG-150A and PAC-SC51KUA basic scheme.

- (2). Power supply of 30VDC (M-NET) from connector of TB3 of Outdoor unit and PAC-SC51KUA. AG-150A can also receive power supply from TB3 connector of the R410A or R407C, R22 Outdoor unit. Yet, Outdoor unit down will lead down to AG-150A too. The kind of connection is possible but not recommended air conditioner system of multiple Outdoor units. The 24VDC can be supplied at TB3 connector of PAC-SC51KUA.

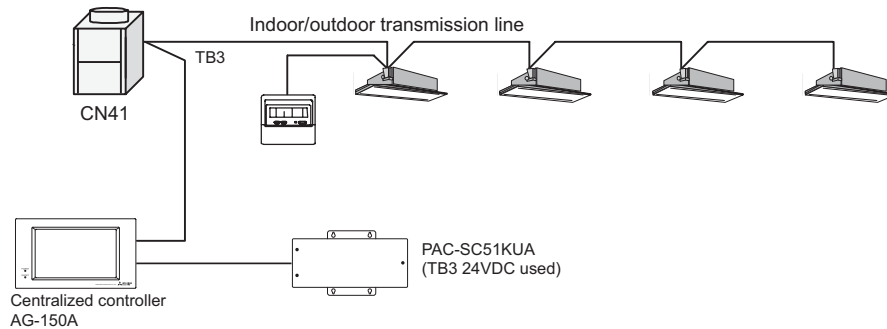

Fig. 2 AG-150A, TB3 and PAC-SC51KUA scheme.

CAUTION

- When applying Charge and/or Peak-cut function on AG-150A, Power Supply Unit (PAC-SC51KUA) is recommended to use. AG-150A is possible to receive power from the one of the Outdoor units, but there is a risk that the failure of power supply from the Outdoor unit will cause AG-150A's function-down on the whole system.

1. System remote controller

2. External input/output usage

(1). External signal input function

※External signal input requires the external I/O adapter (Model: PAC-YG10HA) sold separately.

1). External input

Emergency stop/normal, run/stop and prohibit/permit of local remote controller operation can be controlled for all air conditioners being controlled by using a voltage (12VDC or 24VDC) contact signal from an external source.

(Select with the function select setting.)

No	Function name	External signal input function	Remarks
1	Not in use	Do not use external input signal (factory setting)	
2	Emergency stop (Level signal)	Execute emergency stop/normal with level signal	The local remote controller ON/OFF operations, and the controller ON/OFF operation and prohibit/permit change operations will be prohibited during emergency stop. Timer operation will also be prohibited.
3	ON/OFF (Level signal)	Perform ON/OFF with level signal	The local remote controller ON/OFF operations, and the controller ON/OFF operations and prohibit/permit change operations will be prohibited. Timer operation will also be prohibited.
4	ON/OFF prohibit/permit (Pulse signal)	Perform ON/OFF, prohibit/permit with pulse signals.	Set the pulse width while the contact is ON to 0.5 to 1 sec.

2). Level signal and pulse signal (12VDC or 24VDC)

(A) Level signal

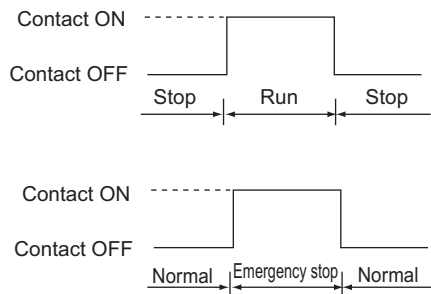

(B) Pulse signal

(Example) for ON/OFF

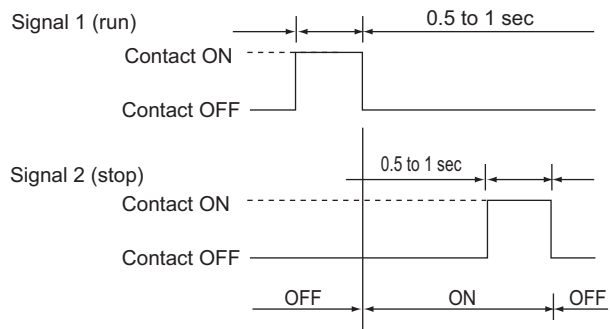

*The prohibit/permit input is the same.

3). External input specifications

CN5	Lead wire	Emergency stop/normal level signal	ON/OFF, level signal	ON/OFF, prohibit/enable pulse signal
No.5	Orange	Emergency stop/normal input	ON/OFF input	ON input
No.6	Yellow	Not used	Not used	OFF input
No.7	Blue	Not used	Not used	Local remote controller operation prohibit input
No.8	Gray	Not used	Not used	Local remote controller operation enable input
No.9	Red	External DC source "+ 12VDC" or "+ 24VDC"		

(A) For level signal

- ① When the emergency stop/normal signal is selected, the status will change from normal to emergency stop when the external input signal contact changes from OFF to ON, and will change from emergency stop to normal when the contact changes from ON to OFF. Air conditioning units that came to an emergency stop will remain stopped after the emergency stop is cancelled. Manually start up each unit to restore the previous operation.
- ② When the ON/OFF signal is selected, the status will change from OFF to ON when the external input signal contact changes from OFF to ON, and will change from ON to OFF when the contact changes from ON to OFF.

(B) For pulse signal

- ① Even if the ON signal is input during ON, the status will remain ON.
- ② If the local remote controller is prohibited, the ON/OFF operation mode and temperature setting operations by the local remote controller will be prohibited.
- ③ Set the pulse width (contact ON time) to 0.5 to 1 sec.

1. System remote controller

4). Recommended circuit example

(A) For level signal

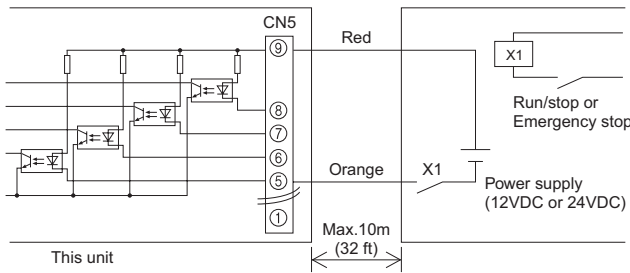

Use relays X1, X2, Y1, and Y2 that meet the following specifications.

Contact rating

Rated voltage $\geq 12\text{VDC}$

Rated current $\geq 0.1\text{A}$

Minimum applicable load $\approx 1\text{mA}$ at DC

(B) For pulse signal

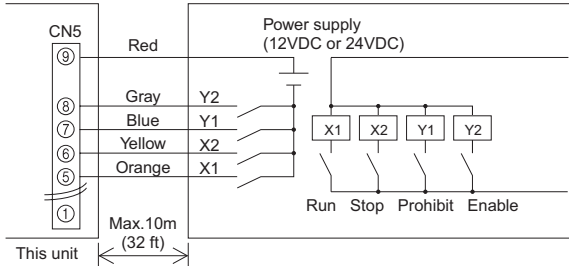

① The contact relay, DC power source, extension cable, etc., must be prepared separately at the site.

② The connection cable can be extended up to 10m (32 ft). (Use a 0.3mm² (AWG 22) or larger wire.)

③ Strip the extra cable near the connector, and securely insulate the exposed section with tape, etc.

(2). External signal output function

* External signal output requires the external I/O adapter (Model: PAC-YG10HA) sold separately.

1). External output

When one or more air conditioners are running, the " ON " signal will be output and if a malfunction occurs in one or more air conditioners, the " Malfunction " signal will be output.

2). External output specifications

CN5	Lead wire	Details of each terminal
No.1	Green	Common (External ground)
No.2	Black	ON/OFF
No.3	Brown	Malfunction/normal

① The " ON " signal is output even while the " Malfunction " signal is being output.

3). Recommended circuit example

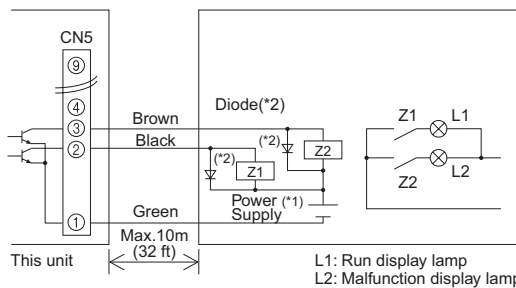

Use Z1 and Z2 relays that meet the following specifications.

Operation coil

Rated voltage : 12VDC, 24VDC

Power Consumption: 0.9W or less

(*1) Prepare a power supply separately according to the relay being used. (12VDC or 24VDC)

(*2) Always insert a diode on both ends of the relay coil.

① Each element will turn on while ON operation or a malfunction occurs.

② The connection cable can be extended up to 10m (32 ft).

③ The relays, lamps, diodes and extension cables, etc, must be prepared separately at the site.

NOTE

* When connecting the external input/output cables to connector CN5 on the controller, punch out the knockout hole.

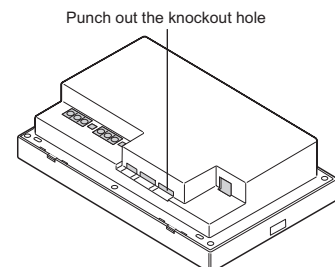

1. System remote controller

3. LAN connection function

When using the LAN connection function, connect the LAN cable to the LAN connector of this device.

*Procure the LAN cable at the site, and use 100 BASE-TX Straight cable.

*For a description of the IP address setting method, refer to Instruction Book.

*LAN is 100 BASE-TX Specification.

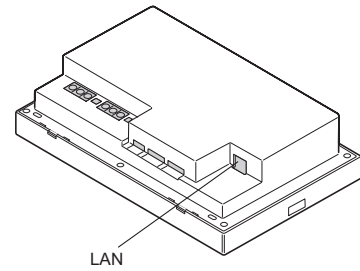

NOTE

* Perform the LAN wiring before installation, and wire up to the body by the same method as wiring the M-NET transmission line.

* When a LAN is already connected, decide the IP address by consultation with the system administrator and connect to the LAN body after changing the IP address.

* Connect AG-150A to a private network.

Use a security device such as a VPN router when connecting the AG-150A to the Internet to prevent unauthorized access.

(If no security devices are installed, the operation settings may be changed by an unauthorized person without the knowledge of the user.)

1. System remote controller

4. Browser screens of AG-150A

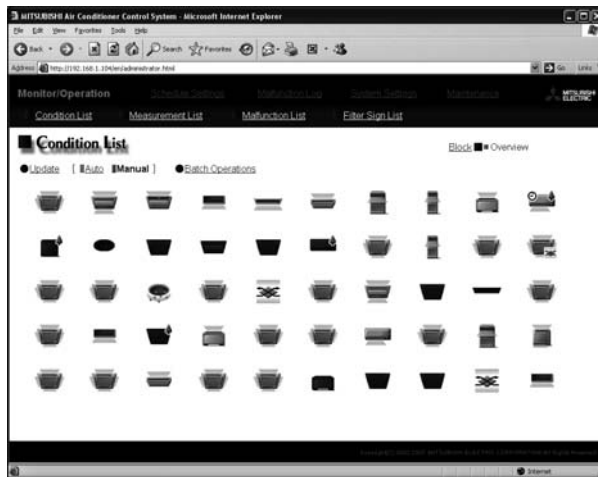

Condition List (Overview)

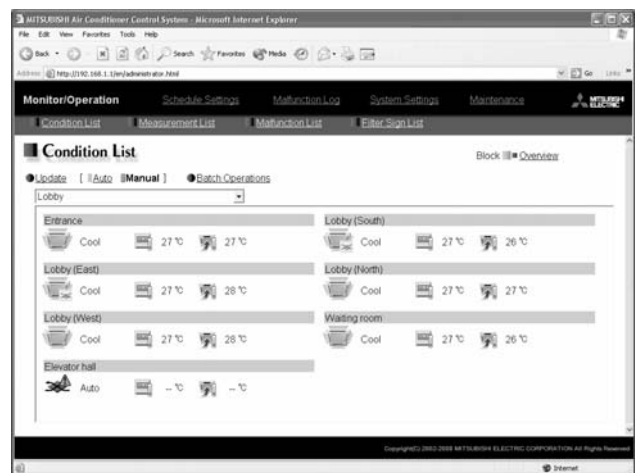

Condition List (Block)

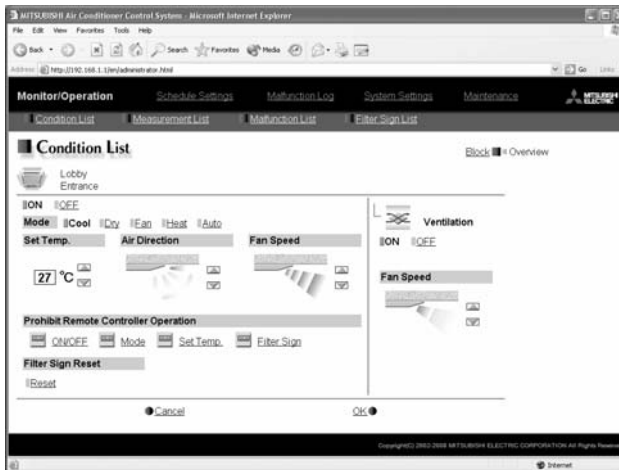

Operation

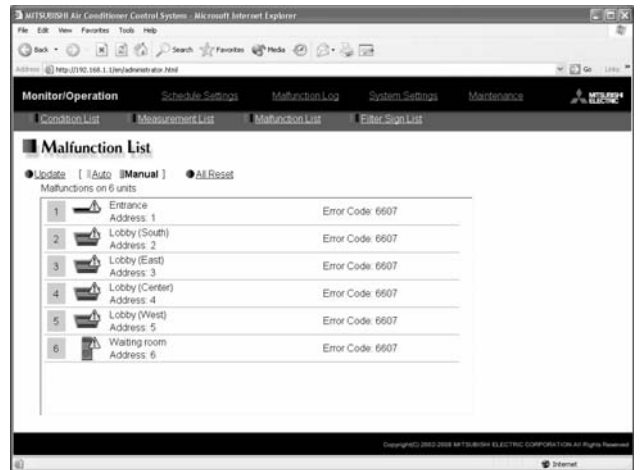

Malfunction List

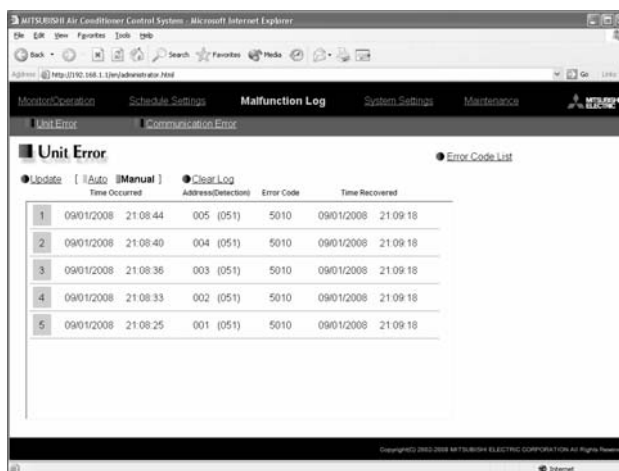

Malfunction Log

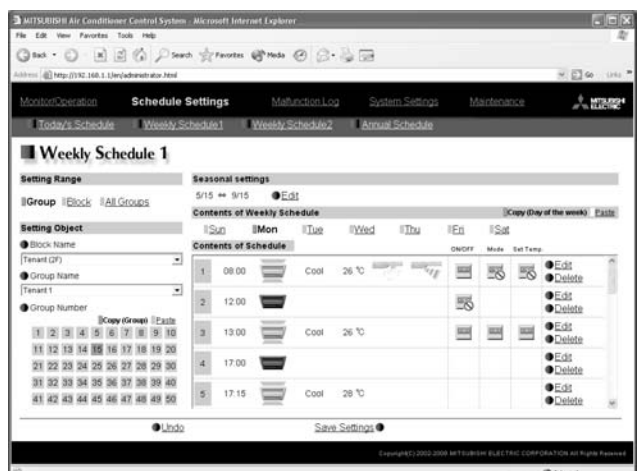

Weekly 1 Schedule

1. System remote controller

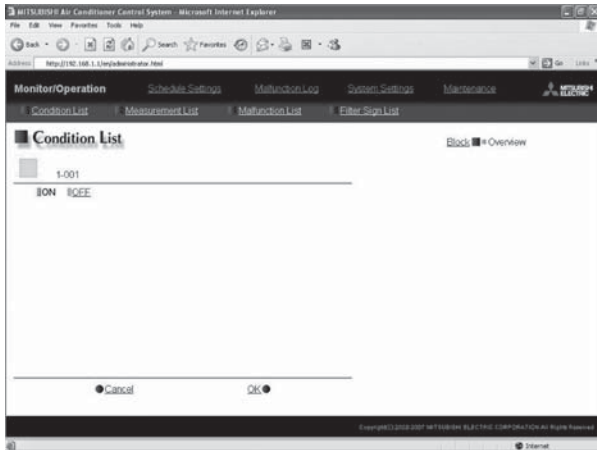

Operation (DIDO Controller)

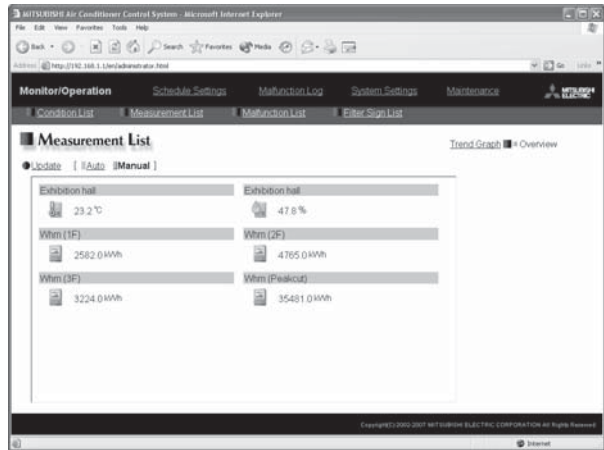

Measurement status monitor (temperature sensor/humidity sensor /measurement meter)

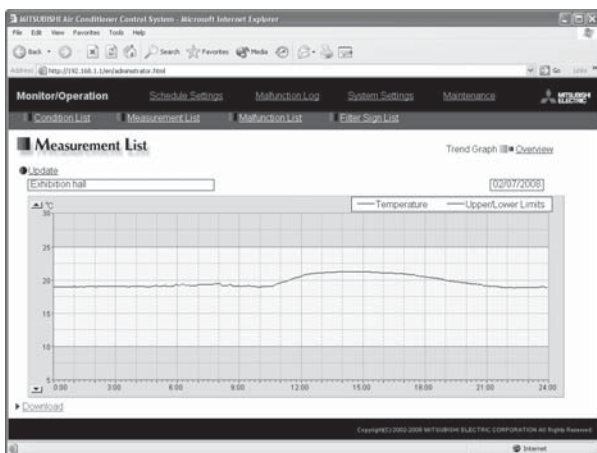

Trend Graph (temperature/humidity)

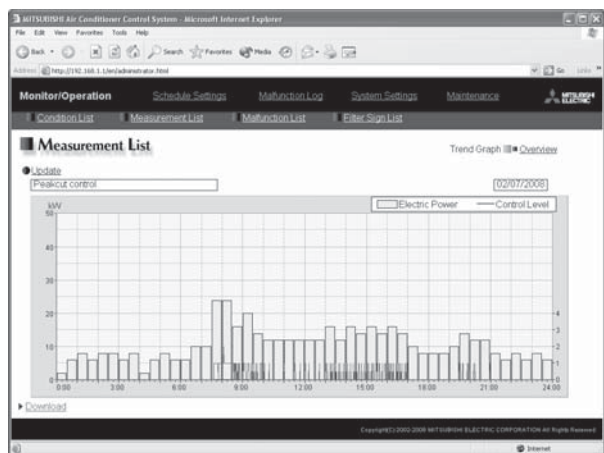

Trend Graph (Peak cut control)

1. System remote controller

5. Liquid crystal displays of AG-150A

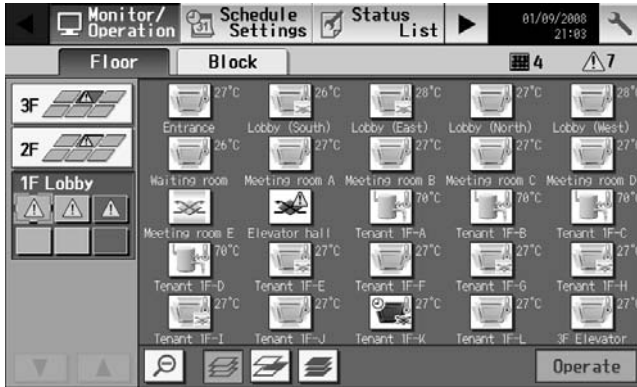

Floor layout screen

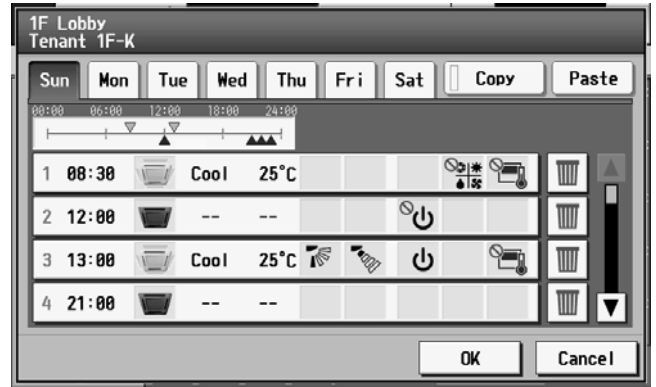

Weekly schedule setting screen

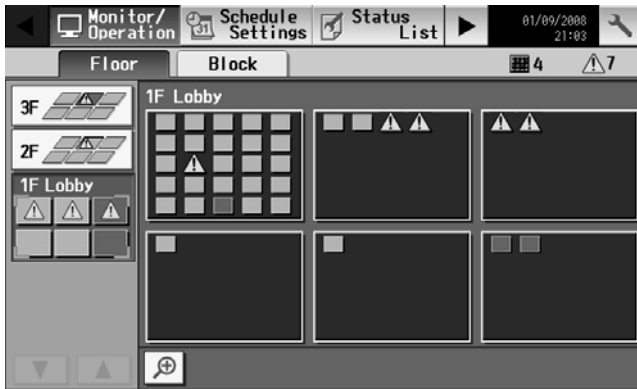

Floor layout screen

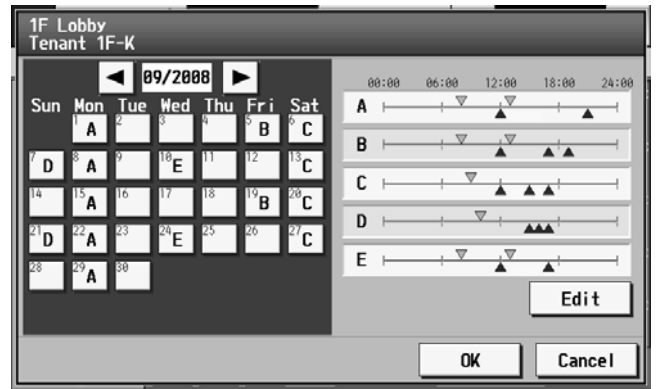

Annual schedule setting screen



Block display screen



Operation screen

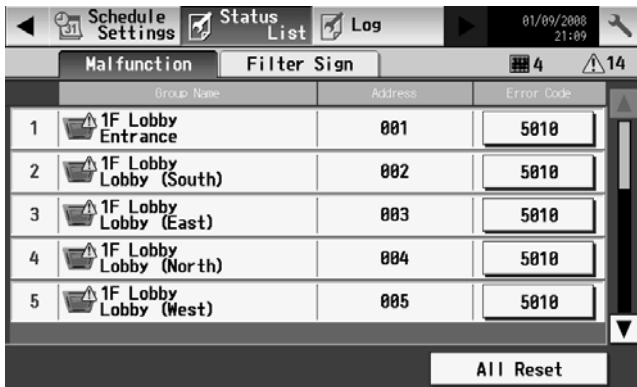

Error status screen

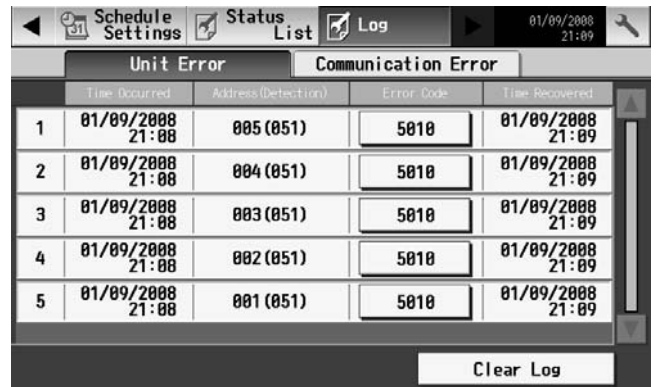

Error history display screen

1. System remote controller

1-2. Power supply unit [PAC-SC51KUA]

PAC-SC51KUA supplies DC power of 23-32V and 24V at TB2 and TB3 respectively; the former is for centralized transmission use and the latter is for AG-150A operation and LAN function use.

1. When using PAC-SC51KUA as the power supplier for system controller, the capacity for system controller is considered as follows.

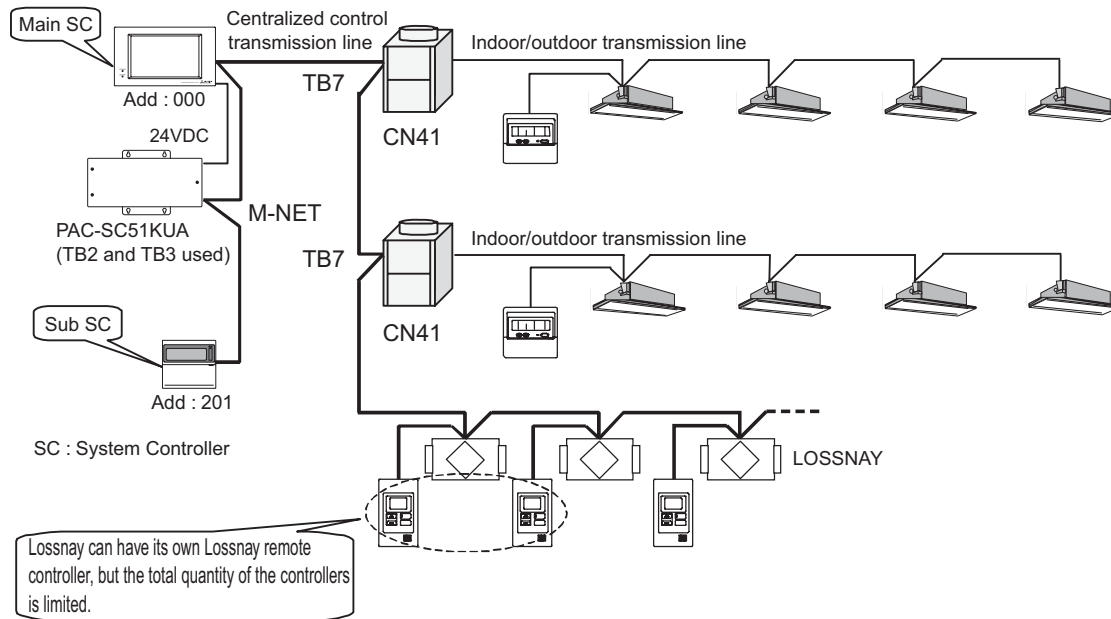

Fig. 1 Equivalent power consumption of controllers

In this case, pay attention to leave the power supply switch connector on CN41 of the Outdoor unit as the factory setting before shipment.

Taking the power consumption of the control board of Indoor unit as 1, the power consumption of various controllers is rated at Table 1.

Table 1 Equivalent power consumption of controllers

Centralized controller			Other system controllers		Remote controllers
AG-150A	G-50A	GB-50A	ON/OFF remote controller (PAC-YT40ANRA)	System remote controller (PAC-44SRA) Schedule timer (PAC-YT34STA)	ME remote controller (PAR-F27MEA) LOSSNAY remote controller (PZ-52SF)
0.5	Not used *1	3	1	0.5	0.25

*1: G-50A cannot be connected to PAC-SC51KUA. Use PAC-SC50KUA to connect G-50A.

PAC-SC51KUA is capable to supply equivalent power up to 5, therefore the maximum connectable number of system controller is as follows.

Table 2 Max. connectable quantity of controller when using PAC-SC51KUA

Centralized controller*2			Other system controllers		Remote controllers
AG-150A	G-50A	GB-50A	ON/OFF remote controller (PAC-YT40ANRA)	System remote controller (PAC-44SRA) Schedule timer (PAC-YT34STA)	ME remote controller (PAR-F27MEA) LOSSNAY remote controller (PZ-52SF)
1unit	Not used *1	1unit	5 units	10 units	20 units

*1: G-50A cannot be connected to PAC-SC51KUA. Use PAC-SC50KUA to connect G-50A.

*2: According to the system restrictions, PAC-SC51KUA can be connected to only one centralized controller.

As the air conditioner control system may combine all kinds of system controllers, the total power consumption of system controllers need to count with Table 2.

For example, the controller system contain 1 AG-150A, 2 ON/OFF remote controllers (PAC-YT40ANRA), 1 schedule timer (PAC-TY34STA), 6 Lossnay remote controllers connected at centralized control communication line.

Then the total power consumption is
 $1 \times 0.5 + 2 \times 1 + 1 \times 0.5 + 6 \times 0.25 = 4.5 < 5$.

One PAC-SC51KUA is therefore enough. The total power consumption should not exceed 5.

1. System remote controller

2. When supply power to 1 AG-150A, the PAC-SC51KUA can supply power to other system controllers as follows.

Table3 Connectable number of system controller when 1 AG-150A is used.

V : Connectable

When connected to one AG-150A		Total number of ON/OFF remote controller(AN)					
		0	1	2	3	4	5
Total number of System remote controller(SR) Schedule timer(ST)	0	V	V	V	V	V	
	1	V	V	V	V	V	
	2	V	V	V	V		
	3	V	V	V	V		
	4	V	V	V			
	5	V	V	V			
	6	V	V				
	7	V	V				
	8	V					
	9	V					
	10						



CAUTION

- When applying Charge and/or Peak-cut function on AG-150A, Power Supply Unit (PAC-SC51KUA) is recommended to use. AG-150A is possible to receive power from one of the Outdoor units, but there is a risk that the failure of power supply from the Outdoor unit will cause AG-150A's functiondown on the whole system.

3. When supply power to 1 GB-50A, the PAC-SC51KUA can supply power to other system controllers as follows.

Table4 Connectable number of system controller when 1 GB-50A is used.

V : Connectable

When connected to one GB-50A		Total number of ON/OFF remote controller(AN)					
		0	1	2	3	4	5
Total number of System remote controller(SR) Schedule timer(ST)	0	V	V	V			
	1	V	V				
	2	V	V				
	3	V					
	4	V					
	5						
	6						
	7						
	8						
	9						
	10						



CAUTION

- When applying Charge and/or Peak-cut function on GB-50A, Power Supply Unit (PAC-SC51KUA) is recommended to use. GB-50A is possible to receive power from one of the Outdoor units, but there is a risk that the failure of power supply from the Outdoor unit will cause AG-150A's functiondown on the whole system.

1. System remote controller

External dimension

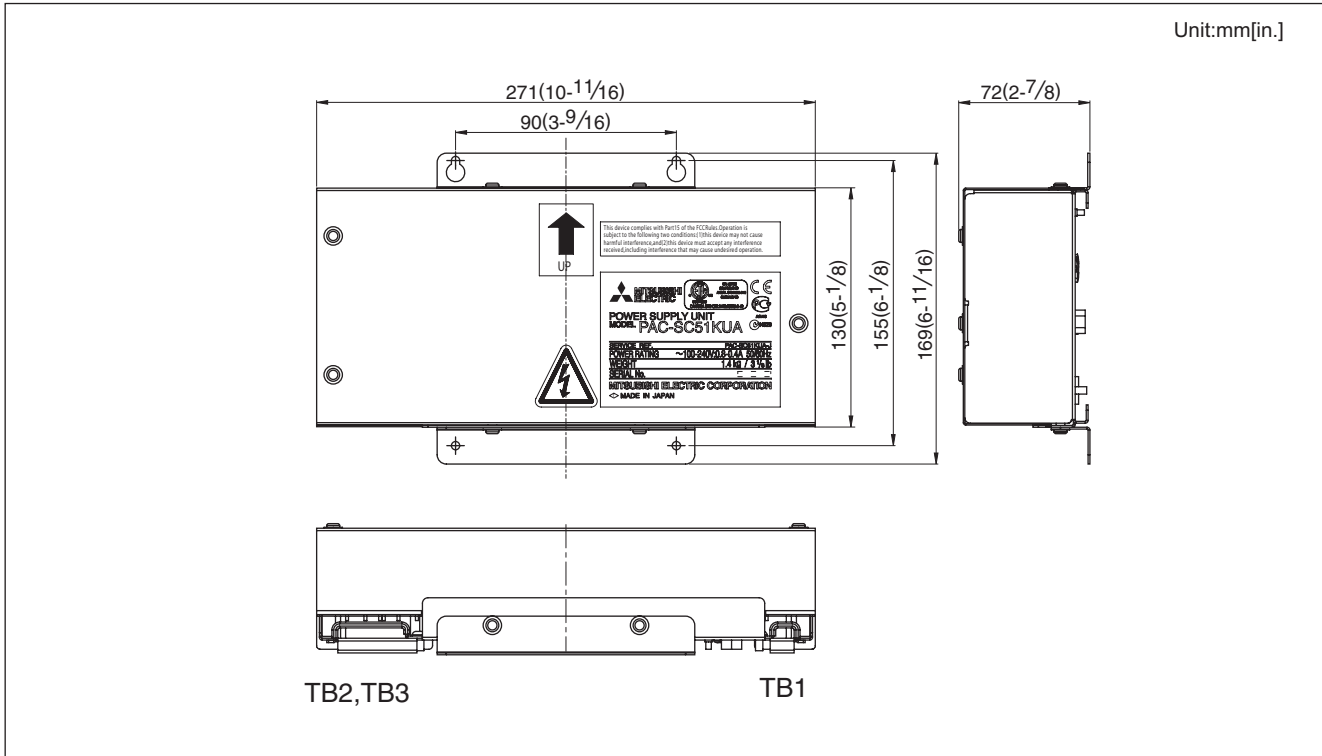

1. System remote controller

1-3. Integrated centralized control software [TG-2000A]

1. Example of Basic System Configuration.

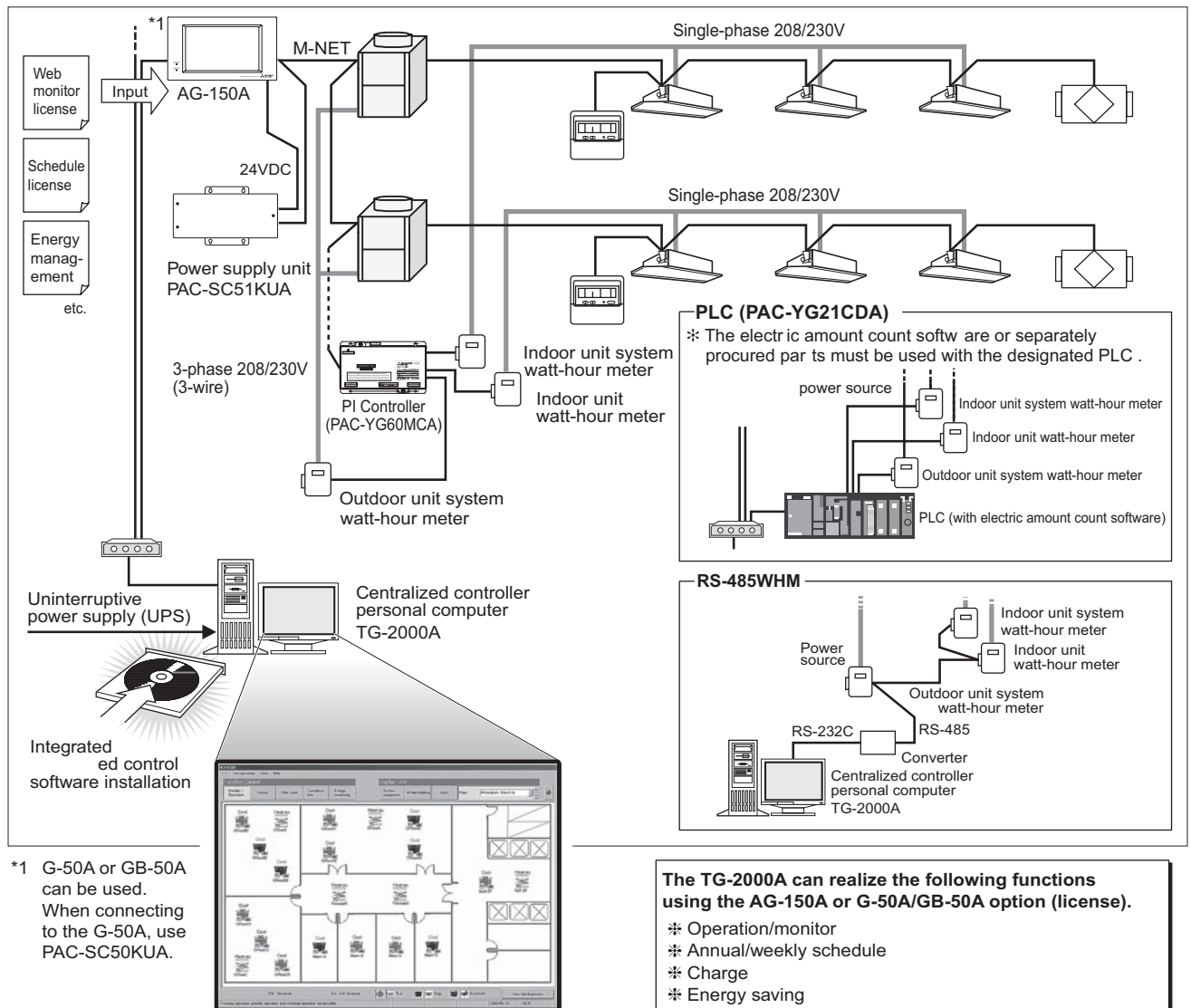

■ Main features of TG-2000A

- ① Up to 2000 indoor units (40 G-50A, GB-50A, or AG-150A units) can be operated and monitored simultaneously.
 - ② The air-conditioner layout can be displayed on the screen, making control and operation easier.
 - ③ The annual and weekly schedules can be set. 5 schedules, such as the summer master and winter master, can be saved in the weekly schedule.
 - ④ Air-conditioning charges can be calculated based on the multiple air-conditioner usage results. The power apportionment percentage data and apportioned power rate can be calculated for each indoor unit using the power apportionment function, and can be output as a CSV format file.
 - Charging without WHM *1 : The user manually inputs the power rate to calculate the air-conditioning charges. (Using a tool)
 - RS-485 WHM charging *1 : The RS-485 WHM value is automatically tabulated to calculate the air-conditioning charges.
 - PLC + pulse WHM charging *1 : The pulse output WHM value is automatically tabulated by the PLC to calculate the air-conditioning charges.
 - PI controller + pulse WHM charging *1 : The pulse output WHM value is automatically tabulated by the PI controller (PAC-YG60MCA) to calculate the air conditioning charges.
 - ⑤ Energy saving operation is possible using the "ON/OFF", "set temperature change", "fan operation changeover" and "performance save operation (60% to 90%)" functions.
 - Energy saving operation matching the amount of power in use is possible by using the PLC's electric amount count software.
 - ⑥ Night Set-Back function operation is possible with schedule settings. *2
 - ⑦ General equipment can be operated and monitored.
 - ⑧ General equipment can be schedule-controlled when using PAC-YG21CDA with PLC or DIDO Controller (PAC-YG66DCA). (For details of PLC refer to Installation Manual of PAC-YG21CDA.)
 - *1: Only one of these functions can be used.
 - *2: With Night Set-Back function, the CITY MULTI system can run at heating mode with target temperature set to 12°C / 54°F under schedule control. (It depends on the outdoor unit model.) This function can protect the room from dropping down to extremely low temperature at mid-night.
- Note: AG-150A (Ver.1.** series) will be compatible with TG-2000A Ver.5.5* or later.**
 Depending on the versions of TG-2000A and AG-150A/G(B)-50A, some of the functions may not be available for use.

The TG-2000A can realize the following functions using the AG-150A or G-50A/GB-50A option (license).

- * Operation/monitor
- * Annual/weekly schedule
- * Charge
- * Energy saving
- * Peak cut

Note : Depending on the versions of TG-2000A and G(B)-50A, some of the functions may not be available for use.

1. System remote controller

2. List of TG-2000A functions

- (1). The data for each AG-150A can be grouped and used to control the operation of up to 2000 units in floor or block units, etc., from the personal computer screen. By using a PLC/PI Controller or a watt-hour meter, the power rate can be apportioned, energy saving control can be executed, and other general equipment can be controlled.

List of integral software functions

Item	Details	AG-150A license			
		Web monitor	Schedule	Energy management	PLC for general equipment
ON/OFF	The units can be turned ON and OFF for all floors or in block, floor or group units.	V			
	The general equipment can be turned ON and OFF. (* A PLC and the general equipment control PLC software required.)	V			
Operation modes	The operation mode can be switched between COOL, DRY, FAN, AUTO and HEAT for all floors or in block, floor or group units.	V			
Temperature setting	The room temperature can be set for all floors or in block, floor or group units. Set temperature range COOL / DRY : 19°C to 30°C / 67°F to 87°F HEAT : 17°C to 28°C / 63°F to 83°F AUTO : 19°C to 28°C / 67°F to 83°F * Depend on the model	V			
Fan speed	The fan speed can be set to four stages for all floors or in block, floor or group units.	V			
Air direction	The air direction can be set in four vertical directions or to swing for all floors or in block, floor or group units.(The selectable air direction differs according to the model.)	V			
Interlocked unit ON/OFF (LOSSNAY)	If there is an interlocked unit (LOSSNAY, the unit can be turned ON (strong/weak) or OFF for all floors or in block, floor or group units. (Note that the ventilation mode cannot be selected for interlocked units.)	V			
Local operation prohibit	The items for which operation with the local remote controller are to be prohibited can be selected for all floors or in block, floor or group units. (The items that can be prohibited are ON/OFF, operation mode, set temperature and filter sign reset.)	V			
Annual / weekly schedule	The annual/weekly (season:weekly x 2) schedule function can be used by registering the license. Five settings, such as seasonal settings for summer and winter, can be saved.	V	V		
Power rate apportionment charging (power rate manual input)	By registering the G-50A unit license number, the power rate apportionment percentage data for each indoor unit can be output in CSV format. The power rate for each tenant can be easily calculated by having each user input the power rate manually.	V		V	
Power rate apportionment charging	By using the PI controller (PAC-YG60MCA) and a pulse output watt-hour meter, the air-conditioning charges can be calculated based on the amount each tenant's air-conditioner has operated. Up to five charging rates can be applied per day.	V		V	
	By using a PLC (with electric amount count software) and a watt-hour meter with pulse transmitter, the air-conditioning charges can be calculated based on the amount each tenant's air-conditioner has operated. Up to five charging rates can be applied per day.				
	An RS-485 watt-hour meter is connected to calculate the air-conditioning charges based on the amount each tenant's air-conditioner has operated. Two charging rates can be applied per day.				
History	The error history and up to 10000 items for operation history can be saved. Each history file can be output as a daily report or monthly report in CSV format. The maximum number of error history data that can be saved depends on the type of errors and the number of connected AG-150A units. The operation history consists only of the operations carried out with the TG-2000A, and is limited to some limited operation items.	V			
Operation time monitor	The cumulative operation time of each indoor unit can be viewed or output as a CSV format file. (This function is valid only when the charging function license is registered.)	V		V	
Filter sign display mask	Automatic display of the filter sign can be disabled. (System batch.) In this case, the filter sign state is confirmed with manual operations .	V			
Energy saving control	Energy saving operation is possible using the "ON/OFF", "set temperature change", "fan operation changeover" and "performance save operation" functions.	V		V	
Energy saving (peak cut)	Energy saving operation matching the amount of power in use is possible. (PLC (with electric amount count software) and watt-hour meter with pulse transmitter are required.)	V		V	
Night Set-Back function *1	Heating from 12°C / 54°F and higher can be set using the schedule.	V			
Set temperature limit *2	The set temperature lower limit can be set for cooling and the upper limit for heating. (Valid only when PAR-F27MEA is used.)	V			
Control other general equipment	The ON/OFF status of the connected general equipment and the error status can be changed or monitored from the DIDO(PAC-YG66DCA).	V			
	It is possible to control other general equipment on ON/OFF operation / monitoring / Alarm / scheduling, if TG-2000A combines PLC installed with PLC software PAC-YG21CDA. Setting inter-lock with CITY MULTI indoor units is possible using PLC(PAC-YG21CDA). (Table setting tool for input/output definition is needed.)	V			V

*1 : With Night Set-Back function, the CITY MULTI R410A system (Not applicable to the PUMY model) can run at heating mode with target temperature set to 12°C/54°F under schedule setting. (PUMY model does not support this function. Set the temperature within the range controllable via a remote controller under schedule setting.)
This function can protect the room from dropping down to extremely low temperature at midnight.

*2 : This function cannot be used with the MA remote controller. (It depends on the indoor unit model.)

Note : Depending on the versions of TG-2000A and AG-150A, some of the functions may not be available for use.

1. System remote controller

3. Browser screens of TG-2000A

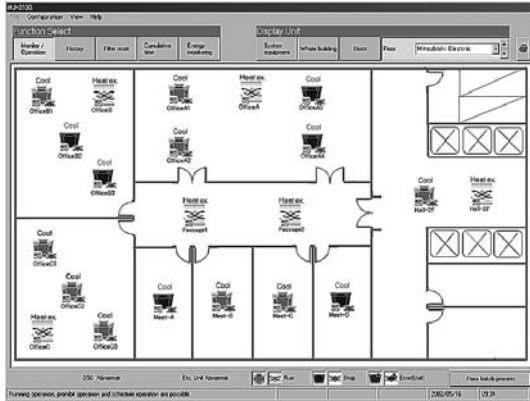

Floor screen

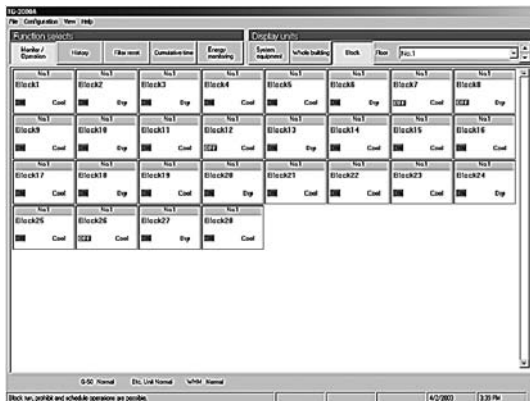

Block screen

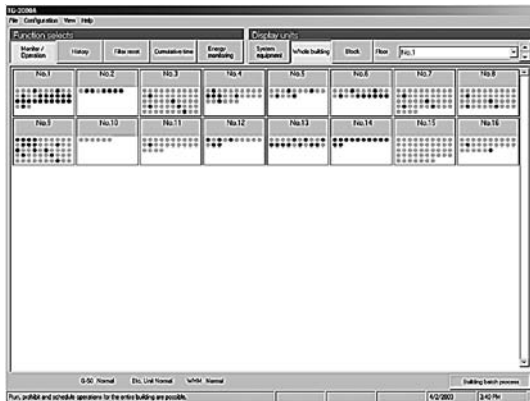

All floor screen

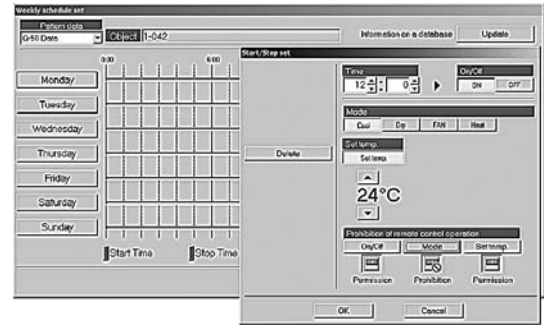

Weekly schedule screen

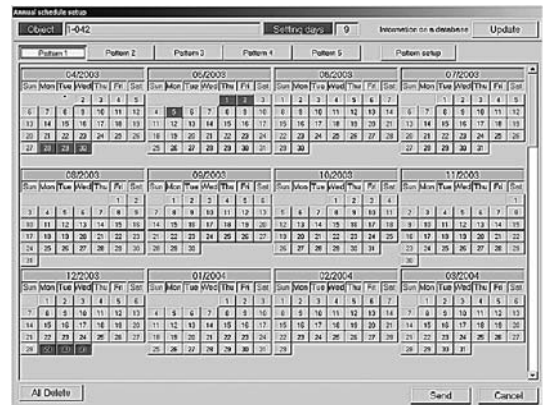

Annual schedule screen

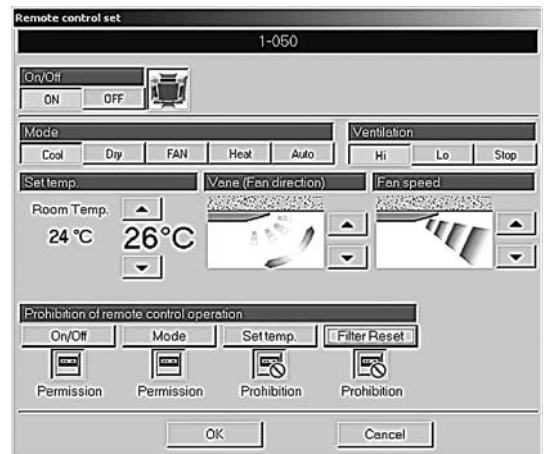

Operation setting screen

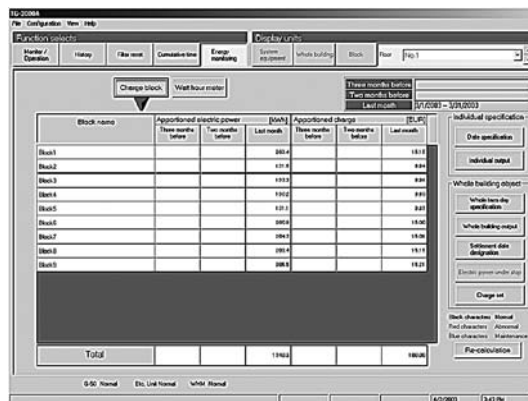

Air-conditioning charge screen

1. System remote controller

4. Requirements (system recommendations)

We recommend the following software and hardware when using this application (TG-2000A).

	TG-2000A version	System Requirements
When AG-150A/G-50A-compatible TG-2000A is used	TG-2000A Ver.5.50 or later *1	OS : Windows Vista/XP Refer to the table below for details.
When G-50A-compatible TG-2000A is used with the range of conventional functions	TG-2000A Ver.5.16 or later	OS : Windows XP/2000 Refer to the table below for details.

*1 : TG-2000A Ver.5.20 is upgraded to Ver.5.50.

Item	Requirement	Recommended
PC	PC/AT interchangeable machine (Recommended: IBM, HP,DELL)	Operation check completed, using IBM, HP and DELL(Business model is recommended)
CPU	Core™ 2 Duo 1.66GHz or faster (Windows Vista for Core 2 Duo)	Core™ 2 Duo 2.4GHz or faster
	Pentium® M 1.7GHz or faster	Pentium® M 2.0GHz or faster
	Pentium® 4 2.4GHz or faster	Pentium® 4 2.8GHz or faster
Memory	In Windows Vista : 1GB or more	2GB or more
	In Windows XP / 2000 : 512MB or more	1GB or more
HDD	Standard 6GB or more (2GB or more of C drive free space necessary)	40GB or more of C drive free space necessary When using the trend function, the drive used for automatic output must have the following free space according to the number of groups. 200 groups = 2GB, 500 Groups = 5GB, 1000 groups = 10GB, 2000 groups = 20GB
	Wide area 20GB or more (Free space)	Standard : max. 200MB/site
Storage device	CD-ROM drive, USB drive	Devices other than those shown at the left may also be installed.
Resolution	1024 x 768 or higher, 65536 colors or more	
Serial port	1 port or more	Required when using RS-485 communication WHM (Not necessary when using PLC or PI Controller)
LAN	1 port (10BASE-T/100BASE-TX)	* 1
Modem	56K modem or TA	Required when using a modem in wide area mode.
USB	2 port or more	It uses it for the data backup.
OS	Windows® Vista Business Service Pack 1	English version only *Computer must support each OS.
	Windows® XP Professional Service Pack 3 *2	English version only *Computer must support each OS.
	Windows® 2000 Professional Service Pack 4 *2	English version only *Computer must support each OS.
Other	Computer must be dedicated for this use (TG-2000A).	Must be used for 24-hour constant operation (Only some functions. Refer to the TG-2000A manual for details.)

*1 Purchase the option, or use the equipment recommended for the computer when purchasing the computer.

*2 Make sure that the correct version of Service Pack is installed. If the wrong version of Service Pack is installed, TG-2000A will not be set up properly.

5. Compatible Units

The TG-2000A has two main functions: centralized control of air conditioners and cost accounting. However, not all functions are available with all air conditioners. (TG-2000A Ver.5.16 / 5.50 or later)

Table: Compatible units and function list (○ : supported, △ : Certain restrictions apply, × : Not supported)

As of Ver.5.16 / 5.50

Function Model	Control/ Maintenance	Charging (Billing) without WHM	Charging (Billing) with WHM	Energy Saving/ Peak Cut
Y series	○		○ *1	○
R2 series	○		○ *1	○
WR2 series	○		○ *1	○
WY series	○		○ *1	○
Multi S series	○		○ *1	○ *5
Indoor unit	○		○ *2	○
LOSSNAY	○		○ *3	△ *6
OA processing unit	○		○ *1	△ *7
"A" control type *4	○ (Adapter required)		○ *1,11	△ *8
"K" control type *4	○ (Converter required)		○ *1,11	△ *9
Room air Conditioner	○ (Adapter required)	×	△ (Requires separate watt hour meters. Bill calculated based on the reading of each watt hour meter.)	△ *10
Air To Water Booster unit	×	×	×	×
Air To Water HEX unit	×	×	×	×

*1 : Can be calculated for each charging block. May not be available with some older models.

*2 : Indoor unit models before Free Plan models do not support a charge apportioning billing method based on the "capacity save". The existence of even a single unit of those types in the system requires that the method of charge apportioning billing be set to either "Thermo on time" or "Fan operation time".

Certain restrictions apply to larger capacity indoor units when malfunctions occur.

*3 : LOSSNAY groups to which the remote controller is connected support the charging system.

*4 : Not all of the A-control and K-control units support these functions. The calculation of the charge for the auxiliary heater may not be handled by these units.

*5 : Outdoor unit capacity control function is not available.

*6 : Only the function to stop the units is available.

*7 : When the attribute is IC (indoor unit): Same type of energy-save control unit as with the Free Plan Indoor unit is possible.

When the attribute is FU (LOSSNAY with heater and humidifier): No direct energy-save control is possible.

*8 : Inverter models support the outdoor unit capacity save control function.

*9 : Outdoor unit Thermo-OFF control function is not supported. Only the fan control function is available.

*10 : Only the temperature control function or the function to stop the units is available.

*11 : For A-control and K-control units, use the apportioned charging methods that are listed in "Thermo on time" or "Fan operation time" section. Otherwise, install an watt-hour meter for each unit.

**DATA BOOK AG-150A
 PAC-SC51KUA**

