

AIR CONDITIONING SYSTEMS

HYBRID
CITY MULTI

DATA BOOK

MODEL

CMB-WP-V-GA1

CMB-WP-V-GB1

PEFY-WP-VMS1-E

PEFY-WP-VMA-E

PLFY-WP-VBM-E

PFFY-WP-VLRMM-E

HYBRID CITY MULTI

Databook

1. INDOOR UNITS

Ceiling concealed (Slim type)	1 - 3
PEFY-WP-VMS1-E	
Ceiling concealed (Middle static pressure type)	1 - 19
PEFY-WP-VMA-E	
Ceiling cassette (4-way flow type)	1 - 37
PLFY-WP-VBM-E	
Floor standing (Concealed type).....	1 - 49
PFFY-WP-VLRMM-E	
HBC controller	1 - 61
CMB-WP-V-GA1, CMB-WP-V-GB1 (for YLM series only)	
CAPACITY TABLES	1 - 77

2. OUTDOOR UNITS

YLM SERIES	2 - 3
------------------	-------

3. SYSTEM DESIGN

SYSTEM DESIGN YLM SERIES.....	3 - 3
-------------------------------	-------

HYBRID CITY MULTI

1. INDOOR UNITS

Ceiling concealed (Slim type)	1 - 3
PEFY-WP-VMS1-E	
Ceiling concealed (Middle static pressure type)	1 - 19
PEFY-WP-VMA-E	
Ceiling cassette (4-way flow type)	1 - 37
PLFY-WP-VBM-E	
Floor standing (Concealed type).....	1 - 49
PFFY-WP-VLRMM-E	
HBC controller.....	1 - 61
CMB-WP-V-GA1, CMB-WP-V-GB1 (for YLM series only)	
CAPACITY TABLES	1 - 77

PEFY-WP-VMS1-E

1. SPECIFICATIONS	1 - 4
2. EXTERNAL DIMENSIONS	1 - 6
3. CENTER OF GRAVITY	1 - 8
4. ELECTRICAL WIRING DIAGRAMS	1 - 9
5. SOUND LEVELS	1 - 10
5-1. Sound levels	1 - 10
5-2. NC curves	1 - 11
6. FAN CHARACTERISTICS CURVES.....	1 - 13
7. OPTIONAL PARTS.....	1 - 17
7-1. Optional parts line up for the Indoor unit.....	1 - 17
7-2. Control box replace kit	1 - 18

1. SPECIFICATIONS

Model			PEFY-WP15VMS1-E	PEFY-WP20VMS1-E	PEFY-WP25VMS1-E	PEFY-WP32VMS1-E	
Power source			1-phase 220-230-240 V 50/60 Hz	1-phase 220-230-240 V 50/60 Hz	1-phase 220-230-240 V 50/60 Hz	1-phase 220-230-240 V 50/60 Hz	
Cooling capacity (Nominal)	*1	kW	1.7	2.2	2.8	3.6	
	*1	kcal/h	1,500	1,900	2,400	3,100	
	*1	BTU/h	5,800	7,500	9,600	12,300	
	*2	Power input	kW	0.050	0.051	0.060	0.071
	*2	Current input	A	0.44	0.49	0.51	0.61
Heating capacity (Nominal)	*3	kW	1.9	2.5	3.2	4.0	
	*3	kcal/h	1,600	2,200	2,800	3,400	
	*3	BTU/h	6,500	8,500	10,900	13,600	
	*2	Power input	kW	0.030	0.031	0.040	0.051
	*2	Current input	A	0.33	0.38	0.40	0.50
External finish			Galvanized steel plate	Galvanized steel plate	Galvanized steel plate	Galvanized steel plate	
External dimension H x W x D			mm	200 x 790 x 700	200 x 790 x 700	200 x 790 x 700	
			in.	7-7/8 x 31-1/8 x 27-9/16	7-7/8 x 31-1/8 x 27-9/16	7-7/8 x 31-1/8 x 27-9/16	7-7/8 x 39 x 27-9/16
Net weight			kg (lbs)	19 (42)	20 (45)	20 (45)	
Heat exchanger			Cross fin (Aluminum fin and copper tube)	Cross fin (Aluminum fin and copper tube)	Cross fin (Aluminum fin and copper tube)	Cross fin (Aluminum fin and copper tube)	
Water Volume			L	0.7	0.9	1.0	
FAN	Type x Quantity		Sirocco fan x 2	Sirocco fan x 2	Sirocco fan x 2	Sirocco fan x 3	
	*4	External static press.	Pa	<5> - 15 - <35> - <50>	<5> - 15 - <35> - <50>	<5> - 15 - <35> - <50>	<5> - 15 - <35> - <50>
			mmH ₂ O	<0.5> - 1.5 - <3.6> - <5.1>	<0.5> - 1.5 - <3.6> - <5.1>	<0.5> - 1.5 - <3.6> - <5.1>	<0.5> - 1.5 - <3.6> - <5.1>
	Motor Type		DC motor	DC motor	DC motor	DC motor	
	Motor output		kW	0.096	0.096	0.096	0.096
	Driving mechanism		Direct-driven by motor	Direct-driven by motor	Direct-driven by motor	Direct-driven by motor	
	Air flow rate		(Low-Mid-High)				
			m ³ /min	5.0 - 6.0 - 7.0	5.5 - 6.5 - 8.0	5.5 - 7.0 - 9.0	8.0 - 9.0 - 11.0
L/s			83 - 100 - 117	92 - 108 - 133	92 - 117 - 150	133 - 150 - 183	
cfm		177 - 212 - 247	194 - 230 - 282	194 - 247 - 318	282 - 318 - 388		
Sound pressure level (measured in anechoic room)			(Low-Mid-High)	(Low-Mid-High)	(Low-Mid-High)	(Low-Mid-High)	
*2			dB <A>	22-24-28	23-25-29	23-26-30	28-30-33
Insulation material			EPS, Polyethylene foam, Urethane foam	EPS, Polyethylene foam, Urethane foam	EPS, Polyethylene foam, Urethane foam	EPS, Polyethylene foam, Urethane foam	
Air filter			PP honeycomb fabric.	PP honeycomb fabric.	PP honeycomb fabric.	PP honeycomb fabric.	
Protection device			Fuse	Fuse	Fuse	Fuse	
Refrigerant control device			-	-	-	-	
Connectable outdoor unit/HBC controller			CITY MULTI YLM series/ CMB-WP-V-GA1, CMB-WP-V-GB1	CITY MULTI YLM series/ CMB-WP-V-GA1, CMB-WP-V-GB1	CITY MULTI YLM series/ CMB-WP-V-GA1, CMB-WP-V-GB1	CITY MULTI YLM series/ CMB-WP-V-GA1, CMB-WP-V-GB1	
Water piping diameter	*5	Inlet	in.	Rc 3/4 screw	Rc 3/4 screw	Rc 3/4 screw	Rc 3/4 screw
	*6	Outlet	in.	Rc 3/4 screw	Rc 3/4 screw	Rc 3/4 screw	Rc 3/4 screw
Field drain pipe size			mm (in.)	O.D.32 (1-1/4)	O.D.32 (1-1/4)	O.D.32 (1-1/4)	O.D.32 (1-1/4)
Drawing	External		KD94T794X01	KD94T794X01	KD94T794X01	KD94T794X01	
	Wiring		KD94T793X01	KD94T793X01	KD94T793X01	KD94T793X01	
	Refrigerant cycle		-	-	-	-	
Standard attachment	Document		Installation Manual, Instruction Book	Installation Manual, Instruction Book	Installation Manual, Instruction Book	Installation Manual, Instruction Book	
	Accessory		Insulation pipe for water pipe, Washer, Drain hose, Tie band	Insulation pipe for water pipe, Washer, Drain hose, Tie band	Insulation pipe for water pipe, Washer, Drain hose, Tie band	Insulation pipe for water pipe, Washer, Drain hose, Tie band	
Optional parts	Control box replace kit		PAC-KE70HS-E	PAC-KE70HS-E	PAC-KE70HS-E	PAC-KE70HS-E	
Remarks			Details on foundation work, duct work, insulation work, electrical wiring, power source switch, and other items shall be referred to the Installation Manual. Due to continuing improvement, above specifications may be subject to change without notice.				

Notes:	Unit converter
1.Nominal cooling conditions Indoor: 27°C.D.B./19°C.W.B. (81°F.D.B./66°F.W.B.), Outdoor: 35°C.D.B. (95°F.D.B.) Pipe length: 7.5 m (24-9/16 ft.), Level difference: 0 m (0 ft.)	kcal/h =kW x 860
2.The values are measured at the factory setting of external static pressure.	BTU/h =kW x 3,412
3.Nominal heating conditions Indoor: 20°C.D.B. (68°F.D.B.), Outdoor: 7°C.D.B./6°C.W.B. (45°F.D.B./43°F.W.B.) Pipe length: 7.5 m (24-9/16 ft.), Level difference: 0 m (0 ft.)	cfm =m ³ /min x 35.31
4.The factory setting of external static pressure is shown without < >. Refer to "Fan characteristics curves", according to the external static pressure, in DATA BOOK for the usable range of air flow rate.	lbs =kg/0.4536
5.Be sure to install a valve on the water outlet.	
6.Install a strainer (40 mesh or more) on the pipe next to the valve to remove the foreign matters.	*Above specification data is subject to rounding variation.
7.Please group units that operate on 1 branch.	

1. SPECIFICATIONS

Model			PEFY-WP40VMS1-E	PEFY-WP50VMS1-E		
Power source			1-phase 220-230-240 V 50/60 Hz	1-phase 220-230-240 V 50/60 Hz		
Cooling capacity (Nominal)	*1	kW	4.5	5.6		
	*1	kcal/h	3,900	4,800		
	*1	BTU/h	15,400	19,100		
	*2	Power input	kW	0.090	0.090	
	*2	Current input	A	0.73	0.77	
Heating capacity (Nominal)	*3	kW	5.0	6.3		
	*3	kcal/h	4,300	5,400		
	*3	BTU/h	17,100	21,500		
	*2	Power input	kW	0.070	0.070	
	*2	Current input	A	0.62	0.66	
External finish			Galvanized steel plate	Galvanized steel plate		
External dimension H x W x D			mm	200 x 990 x 700	200 x 1,190 x 700	
			in.	7-7/8 x 39 x 27-9/16	7-7/8 x 46-7/8 x 27-9/16	
Net weight			kg (lbs)	25 (56)	27 (60)	
Heat exchanger			Cross fin (Aluminum fin and copper tube)	Cross fin (Aluminum fin and copper tube)		
Water Volume		L	1.0	1.7		
FAN	Type x Quantity		Sirocco fan x 3	Sirocco fan x 4		
	*4	External static press.	Pa	<5> - 15 - <35> - <50>	<5> - 15 - <35> - <50>	
			mmH ₂ O	<0.5> - 1.5 - <3.6> - <5.1>	<0.5> - 1.5 - <3.6> - <5.1>	
	Motor Type		DC motor	DC motor		
	Motor output		kW	0.096	0.096	
	Driving mechanism		Direct-driven by motor	Direct-driven by motor		
	Air flow rate		(Low-Mid-High)		(Low-Mid-High)	
			m ³ /min	9.5 - 11.0 - 13.0	12.0 - 14.0 - 16.5	
			L/s	158 - 183 - 217	200 - 233 - 275	
			cfm	335 - 388 - 459	424 - 494 - 583	
Sound pressure level (measured in anechoic room)			(Low-Mid-High)	(Low-Mid-High)		
*2		dB <A>	30-32-35	30-33-36		
Insulation material			EPS, Polyethylene foam, Urethane foam	EPS, Polyethylene foam, Urethane foam		
Air filter			PP honeycomb fabric.	PP honeycomb fabric.		
Protection device			Fuse	Fuse		
Refrigerant control device			-	-		
Connectable outdoor unit/HBC controller			CITY MULTI YLM series/ CMB-WP-V-GA1, CMB-WP-V-GB1	CITY MULTI YLM series/ CMB-WP-V-GA1, CMB-WP-V-GB1		
*5 *6	Inlet	in.	Rc 3/4 screw	Rc 3/4 screw		
	Outlet	in.	Rc 3/4 screw	Rc 3/4 screw		
Field drain pipe size			mm (in.)	O.D.32 (1-1/4)	O.D.32 (1-1/4)	
Drawing	External		KD94T794X01	KD94T794X01		
	Wiring		KD94T793X01	KD94T793X01		
	Refrigerant cycle		-	-		
Standard attachment	Document		Installation Manual, Instruction Book	Installation Manual, Instruction Book		
	Accessory		Insulation pipe for water pipe, Washer, Drain hose, Tie band	Insulation pipe for water pipe, Washer, Drain hose, Tie band		
Optional parts	Control box replace kit		PAC-KE70HS-E	PAC-KE70HS-E		
Remarks			Details on foundation work, duct work, insulation work, electrical wiring, power source switch, and other items shall be referred to the Installation Manual. Due to continuing improvement, above specifications may be subject to change without notice.			

Notes:	Unit converter
1. Nominal cooling conditions Indoor: 27°C D.B./19°C W.B. (81°F D.B./66°F W.B.), Outdoor: 35°C D.B. (95°F D.B.) Pipe length: 7.5 m (24-9/16 ft.), Level difference: 0 m (0 ft.)	kcal/h = kW x 860
2. The values are measured at the factory setting of external static pressure.	BTU/h = kW x 3,412
3. Nominal heating conditions Indoor: 20°C D.B. (68°F D.B.), Outdoor: 7°C D.B./6°C W.B. (45°F D.B./43°F W.B.) Pipe length: 7.5 m (24-9/16 ft.), Level difference: 0 m (0 ft.)	cfm = m ³ /min x 35.31
4. The factory setting of external static pressure is shown without < >. Refer to "Fan characteristics curves", according to the external static pressure, in DATA BOOK for the usable range of air flow rate.	lbs = kg/0.4536
5. Be sure to install a valve on the water outlet.	
6. Install a strainer (40 mesh or more) on the pipe next to the valve to remove the foreign matters.	*Above specification data is subject to rounding variation.
7. Please group units that operate on 1 branch.	

2. EXTERNAL DIMENSIONS

PEFY

PEFY-WP15, 20, 25, 32, 40, 50VMS1-E

Unit : mm

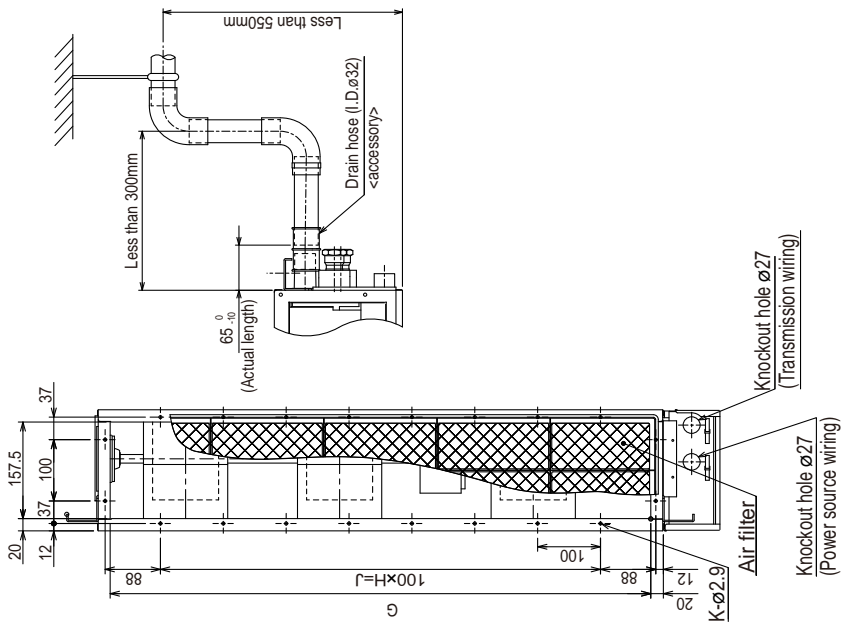

- Note 1. Use M10 screw for the suspension bolt (field supply).
 Note 2. Keep the service space for the maintenance at the bottom.
 Note 3. This chart indicates for PEFY-WP32, 40VMS1-E models, which has 3 fans.
 PEFY-WP15, 20, 25VMS1-E models have 2 fans.
 PEFY-WP50VMS1-E models have 4 fans.
 Note 4. In case an inlet duct is used, remove the air filter (supply with the unit), then install the filter (field supply) at suction side.

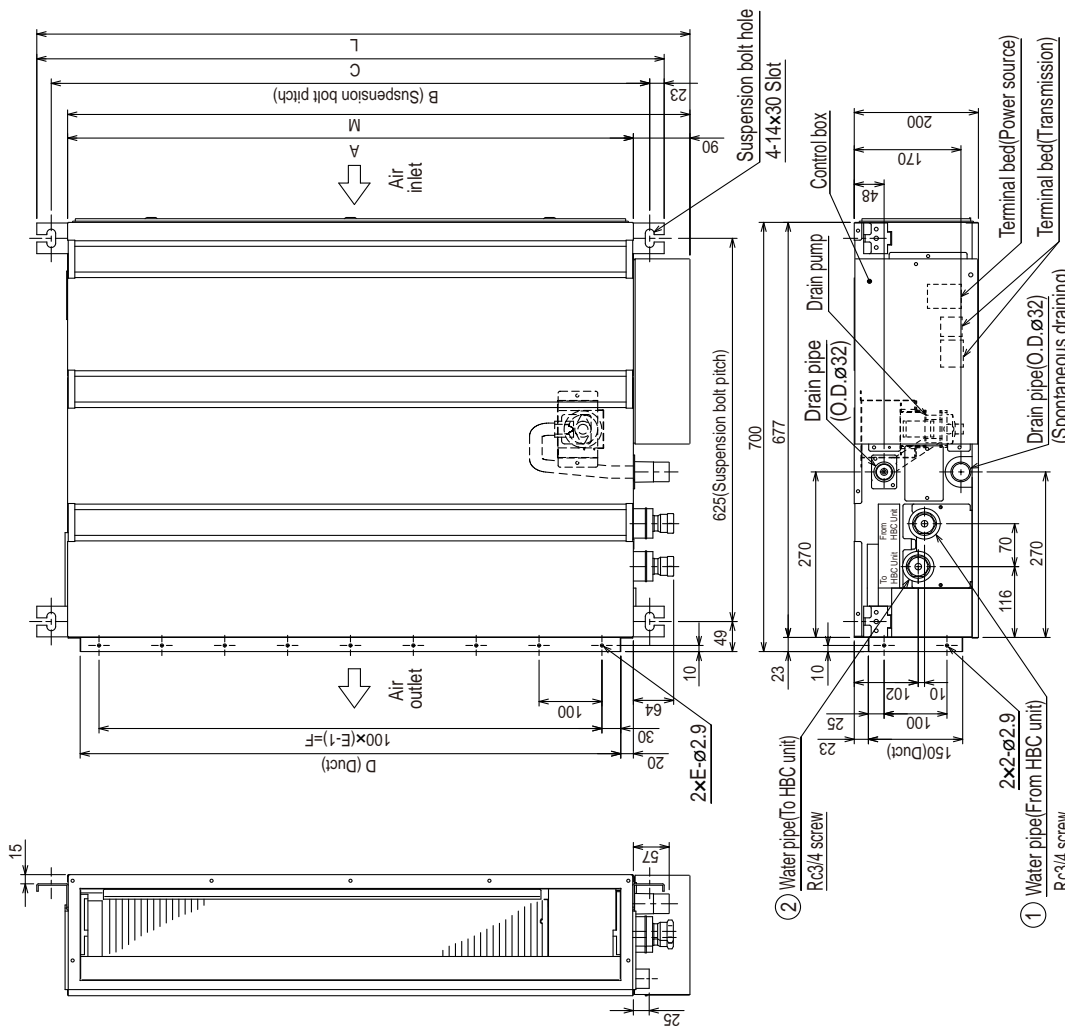

Model	A	B	C	D	E	F	G	H	J	K	L	M	① Water pipe (From HBC unit)	② Water pipe (To HBC unit)	Rc3/4 screw
PEFY-WP15VMS1-E	700	752	798	660	7	600	660	5	500	16	839	790			
PEFY-WP20VMS1-E	700	752	798	660	7	600	660	5	500	16	839	790			
PEFY-WP25VMS1-E	900	952	998	860	9	800	860	7	700	20	1039	990			
PEFY-WP32VMS1-E	1100	1152	1198	1060	11	1000	1060	9	900	24	1239	1190			
PEFY-WP40VMS1-E	1100	1152	1198	1060	11	1000	1060	9	900	24	1239	1190			

2. EXTERNAL DIMENSIONS

PEFY-WP15, 20, 25, 32, 40, 50VMS1-E

Unit : mm

[Maintenance access space]
Secure enough access space to allow for the maintenance, inspection, and replacement of the motor, fan, drain pump, heat exchanger, and electric box in one of the following ways.
Select an installation site for the indoor unit so that its maintenance access space will not be obstructed by beams or other objects.

- (1) When a space of 300mm or more is available below the unit between the unit and the ceiling. (Fig.1)
-Create access door 1 and 2 (450x450mm each) as shown in Fig.2.
(Access door 2 is not required if enough space is available below the unit for a maintenance worker to work in.)
- (2) When a space of less than 300mm is available below the unit between the unit and the ceiling.
(At least 20mm of space should be left below the unit as shown in Fig.3.)
-Create access door 1 diagonally below the electric box and access door 3 below the unit as shown in Fig.4.
or
-Create access door 4 below the electric box and the unit as shown in Fig.5.

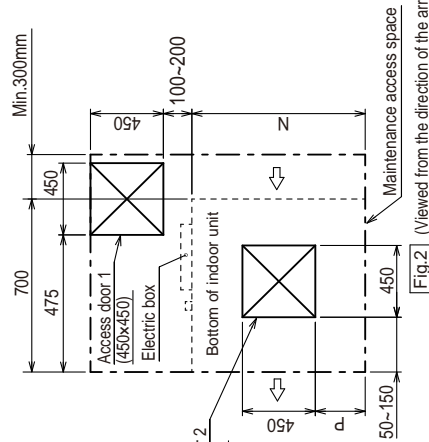
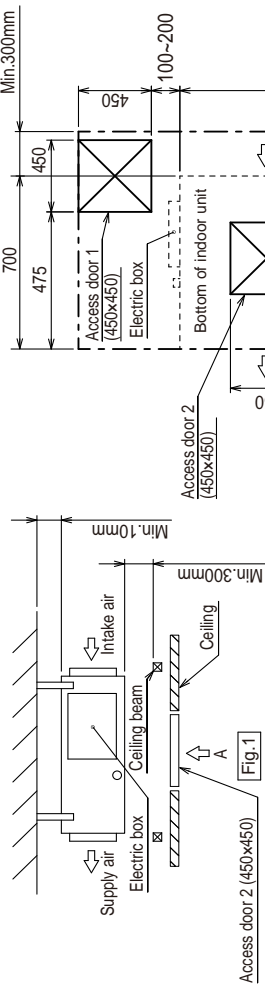

Fig.2 (Viewed from the direction of the arrow A)

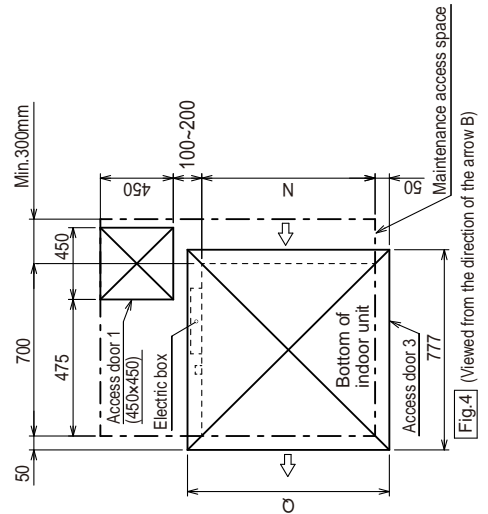

Fig.4 (Viewed from the direction of the arrow B)

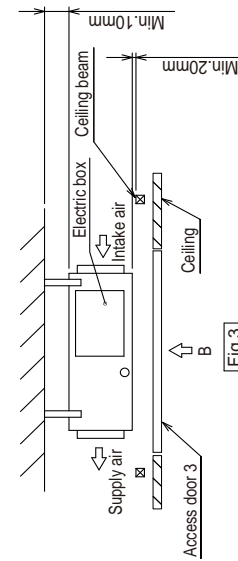

Fig.3

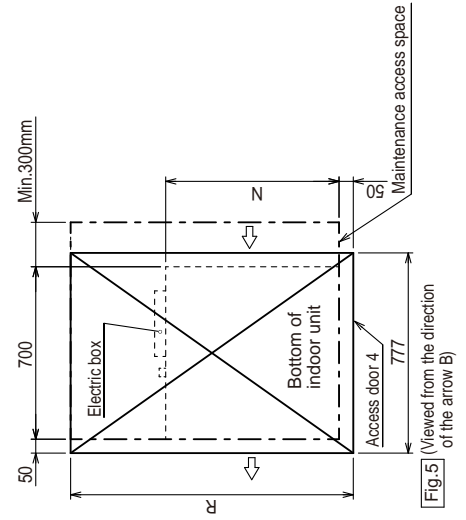

Fig.5 (Viewed from the direction of the arrow B)

Model	N	P	Q	R
PEFY-WP15VMS1-E	700	50~150	800	1300
PEFY-WP20VMS1-E	700	50~150	800	1300
PEFY-WP25VMS1-E	900	150~250	1000	1500
PEFY-WP32VMS1-E	900	150~250	1000	1500
PEFY-WP40VMS1-E	1100	250~350	1200	1700
PEFY-WP50VMS1-E	1100	250~350	1200	1700

3. CENTER OF GRAVITY

PEFY

PEFY-WP15, 20, 25, 32, 40, 50VMS1-E

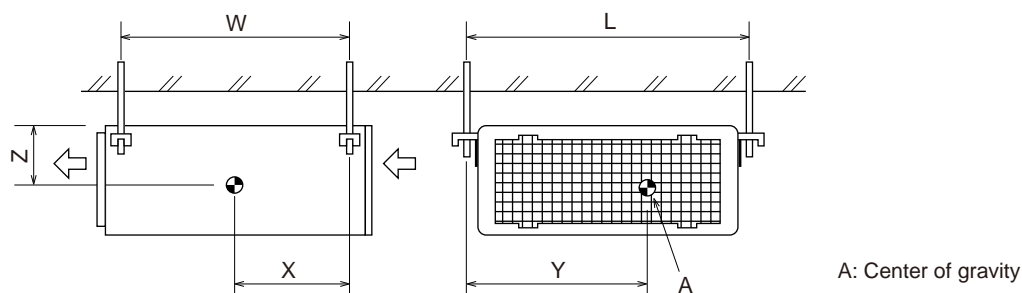

(mm)[in]

Model name	W	L	X	Y	Z
PEFY-WP15VMS1-E	625 [24-5/8]	752 [29-5/8]	263 [10-3/8]	338 [13-5/16]	105 [4-5/32]
PEFY-WP20VMS1-E	625 [24-5/8]	752 [29-5/8]	263 [10-3/8]	338 [13-5/16]	105 [4-5/32]
PEFY-WP25VMS1-E	625 [24-5/8]	752 [29-5/8]	263 [10-3/8]	338 [13-5/16]	105 [4-5/32]
PEFY-WP32VMS1-E	625 [24-5/8]	952 [37-1/2]	280 [11-1/32]	422 [16-5/8]	104 [4-1/8]
PEFY-WP40VMS1-E	625 [24-5/8]	952 [37-1/2]	280 [11-1/32]	422 [16-5/8]	104 [4-1/8]
PEFY-WP50VMS1-E	625 [24-5/8]	1152 [45-3/8]	285 [11-1/4]	511 [20-1/8]	104 [4-1/8]

4. ELECTRICAL WIRING DIAGRAMS

PEFY-WP15, 20, 25, 32, 40, 50VMS1-E

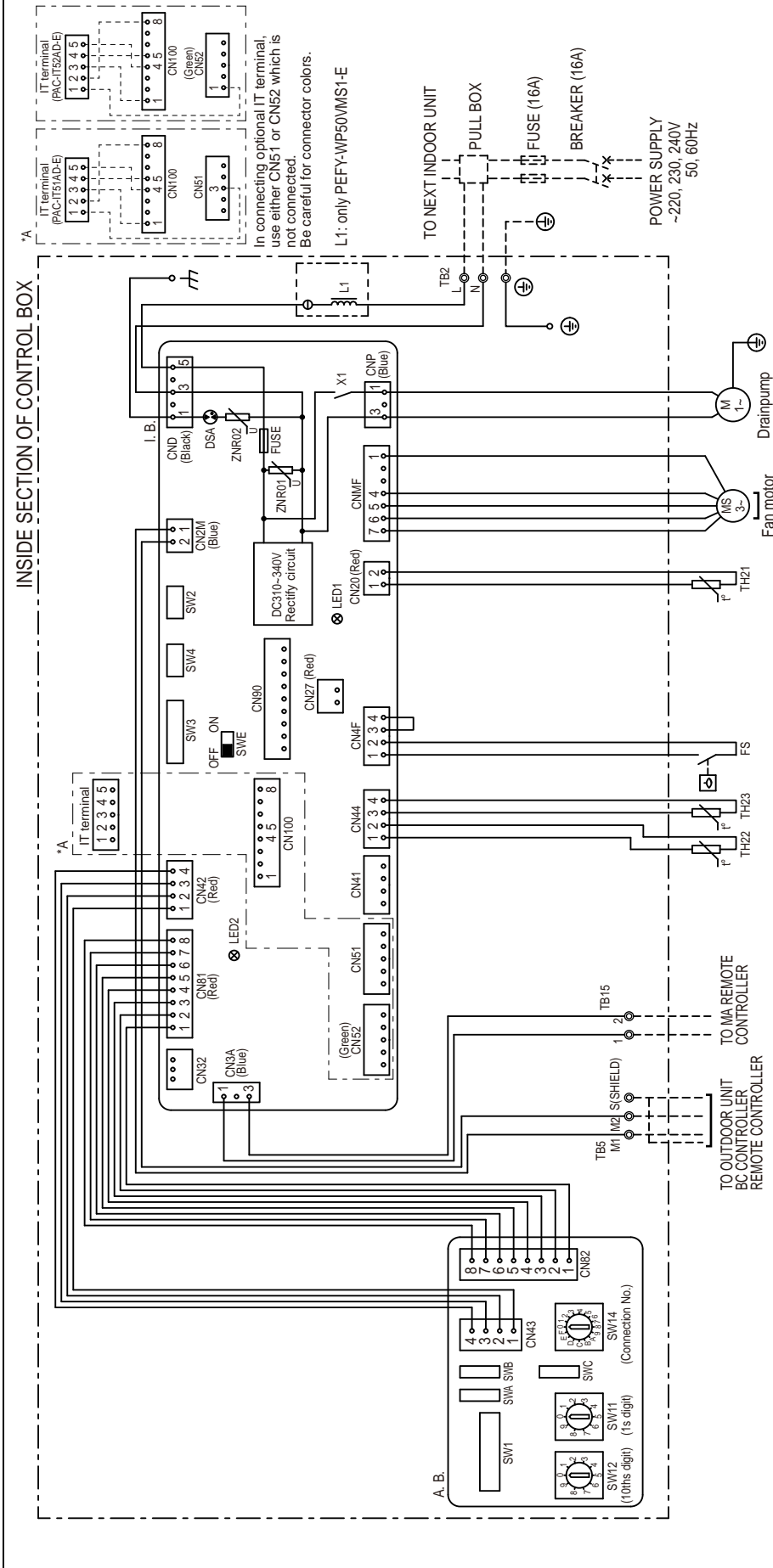

SYMBOL EXPLANATION

SYMBOL	NAME	SYMBOL	NAME	SYMBOL	NAME
i.B.	Indoor controller board	SW3(i.B.)	Switch (for mode selection)	SW3(i.B.)	Switch (for mode selection)
A. B.	Address board	CN41	Connector (Remote switch)	SW4(i.B.)	Switch (for model selection)
TB2	Power source terminal block	CN51	Connector (HA terminal-A)	SW4(i.B.)	Switch (for model selection)
TB5	Transmission terminal block	CN52	Connector (Centrally control)	SWE(i.B.)	Connector (emergency operation)
TB15	Transmission terminal block	CN90	Connector (Remote indication)	SW1(A.B.)	Switch (for mode selection)
FUSE	Fuse AC250V 6.3A	CN100	Connector (Wireless)	SW11(A.B.)	Switch (1s digit address set)
ZNR01, 02	Variator	FS	Float switch	SW12(A.B.)	Switch (10ths digit address set)
DSA	Arrester	TH21	Thermistor (inlet air temp.detection)	SW14(A.B.)	Switch (connection No.set)
X1	Aux. relay	TH22	Thermistor (piping temp.detection/water in)	SWA(A.B.)	Switch (for static pressure selection)
L1	AC reactor (Power factor improvement)	TH23	Thermistor (piping temp.detection/water out)	SWB(A.B.)	Switch (for model selection)
CN27	Connector (Damper)	SW2(i.B.)	Switch (for capacity code)	SWC(A.B.)	Switch (for static pressure selection)

5. SOUND LEVELS

5-1. Sound levels

PEFY-WP-VMS1-E

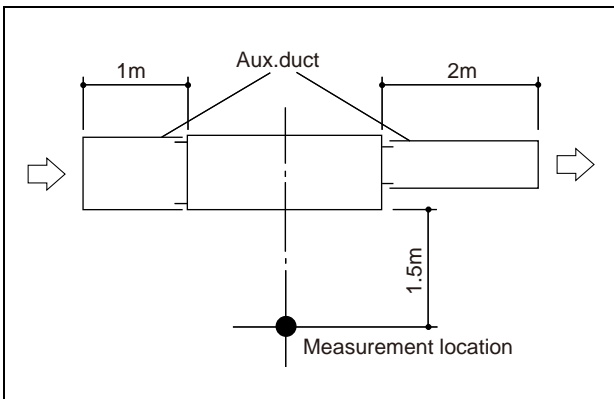

* Measured in anechoic room.

Sound level at anechoic room : Low-Mid-High

		Sound level dB (A)			
		5Pa	15Pa	35Pa	50Pa
PEFY-WP15VMS1-E	220-240V	22 - 24 - 26	22 - 24 - 28	23 - 26 - 29	23 - 27 - 30
PEFY-WP20VMS1-E	220-240V	22 - 25 - 28	23 - 25 - 29	24 - 27 - 30	25 - 28 - 32
PEFY-WP25VMS1-E	220-240V	22 - 25 - 29	23 - 26 - 30	24 - 28 - 31	25 - 29 - 33
PEFY-WP32VMS1-E	220-240V	26 - 28 - 30	28 - 30 - 33	30 - 32 - 35	31 - 33 - 36
PEFY-WP40VMS1-E	220-240V	29 - 31 - 34	30 - 32 - 35	31 - 34 - 37	32 - 34 - 38
PEFY-WP50VMS1-E	220-240V	29 - 32 - 35	30 - 33 - 36	31 - 35 - 39	32 - 36 - 40

5. SOUND LEVELS

5-2. NC curves

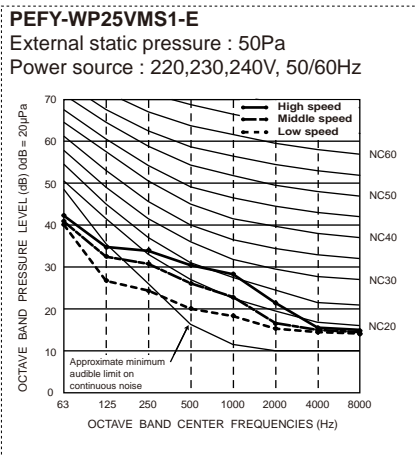
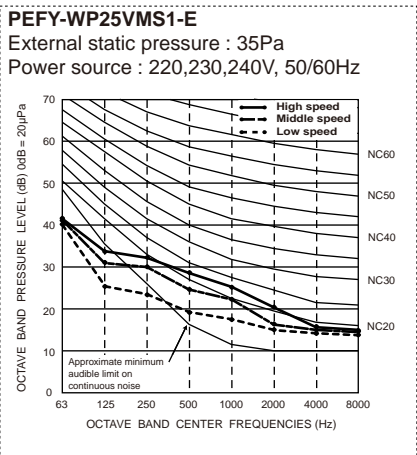
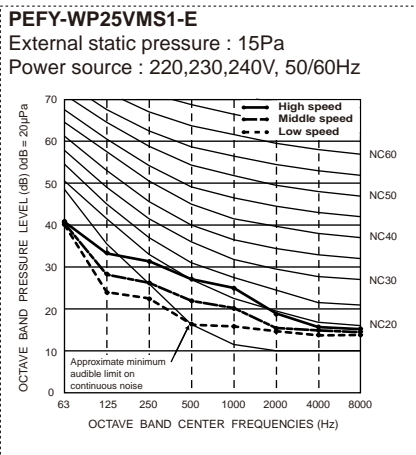
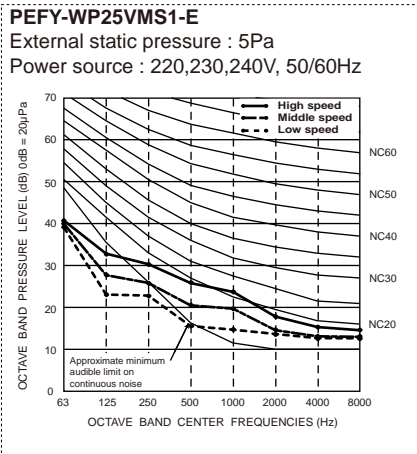
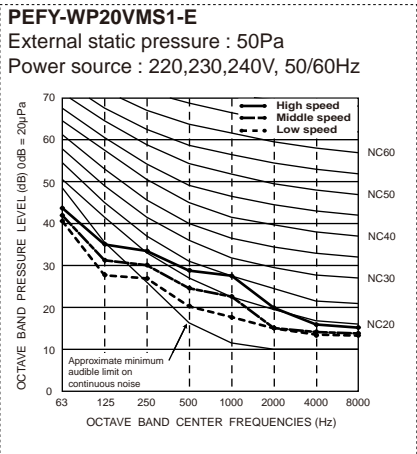
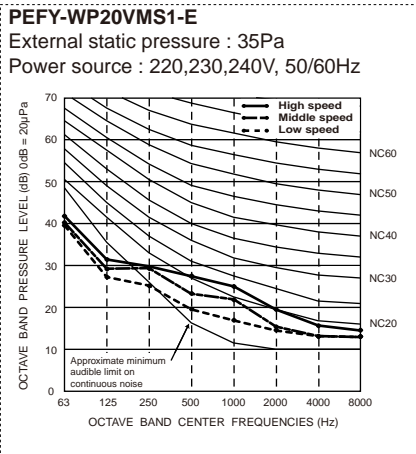
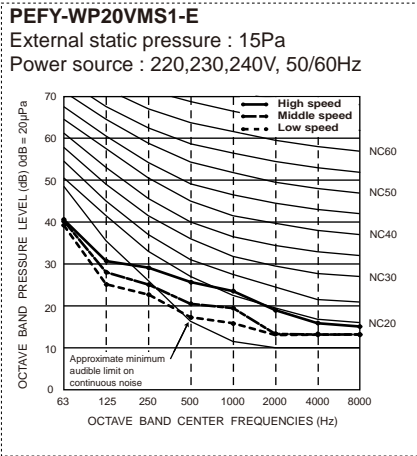
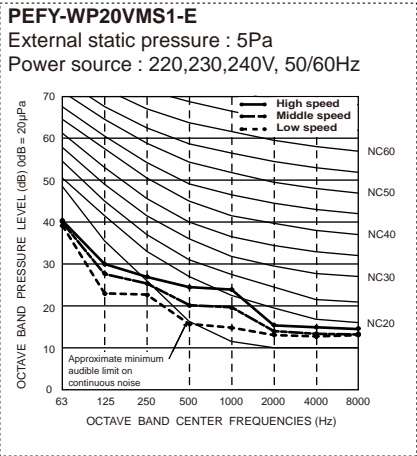
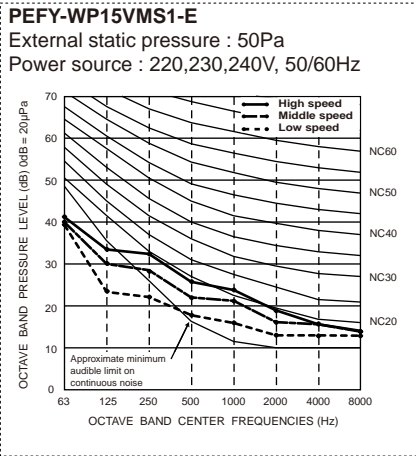
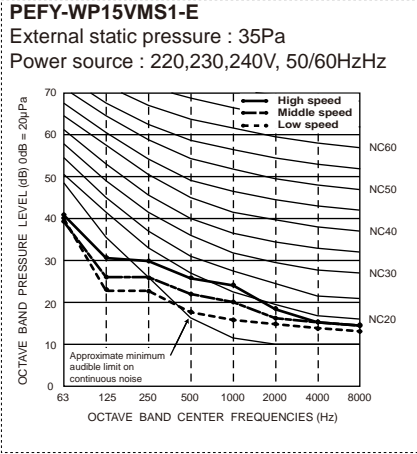
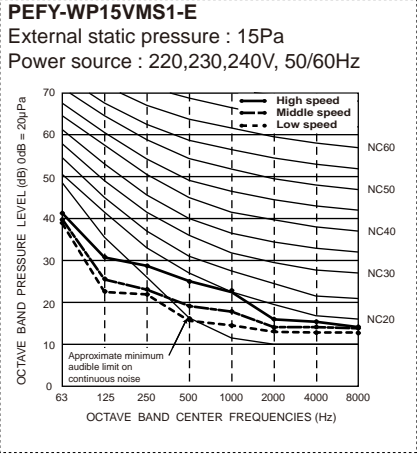
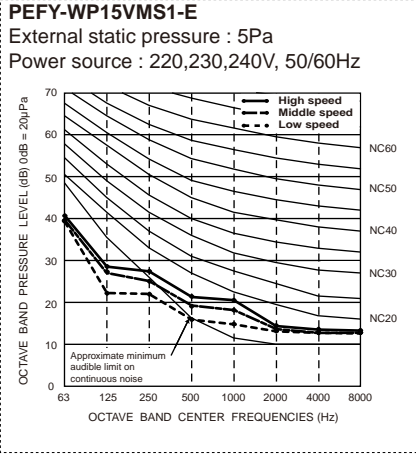

5. SOUND LEVELS

PEFY

PEFY-WP32VMS1-E

External static pressure : 5Pa
Power source : 220,230,240V, 50/60Hz

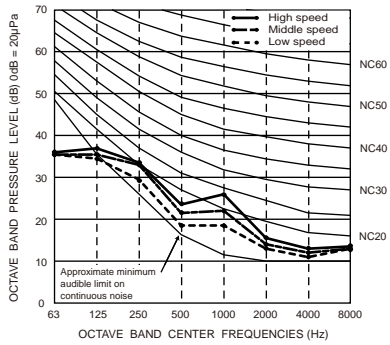

PEFY-WP32VMS1-E

External static pressure : 15Pa
Power source : 220,230,240V, 50/60Hz

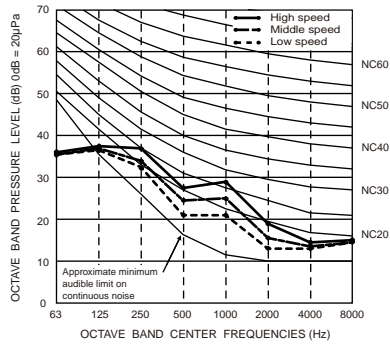

PEFY-WP32VMS1-E

External static pressure : 35Pa
Power source : 220,230,240V, 50/60Hz

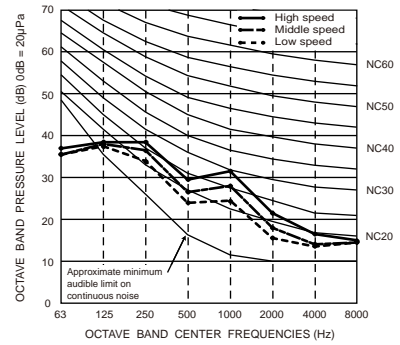

PEFY-WP32VMS1-E

External static pressure : 50Pa
Power source : 220,230,240V, 50/60Hz

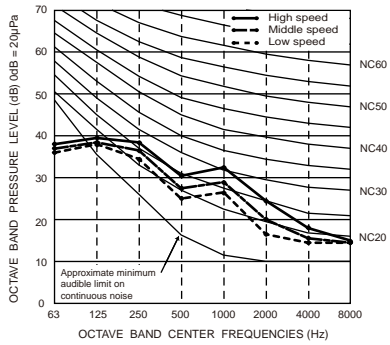

PEFY-WP40VMS1-E

External static pressure : 5Pa
Power source : 220,230,240V, 50/60Hz

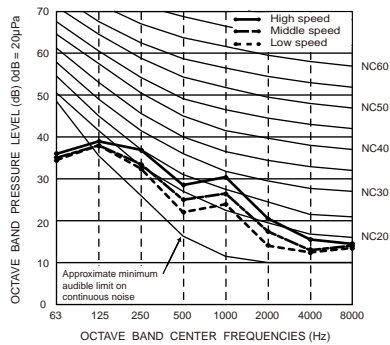

PEFY-WP40VMS1-E

External static pressure : 15Pa
Power source : 220,230,240V, 50/60Hz

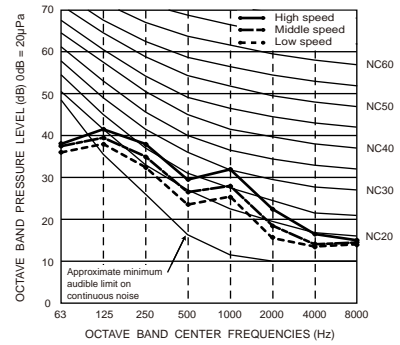

PEFY-WP40VMS1-E

External static pressure : 35Pa
Power source : 220,230,240V, 50/60Hz

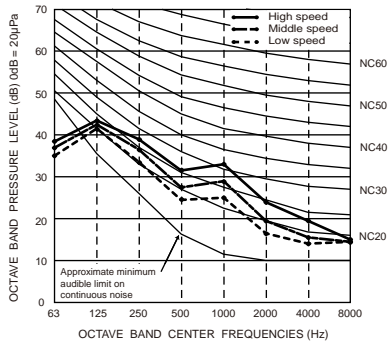

PEFY-WP40VMS1-E

External static pressure : 50Pa
Power source : 220,230,240V, 50/60Hz

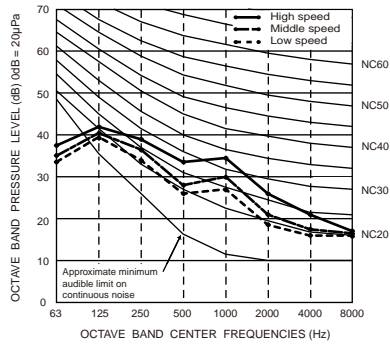

PEFY-WP50VMS1-E

External static pressure : 5Pa
Power source : 220,230,240V, 50/60Hz

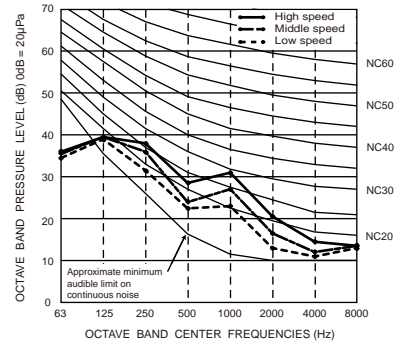

PEFY-WP50VMS1-E

External static pressure : 15Pa
Power source : 220,230,240V, 50/60Hz

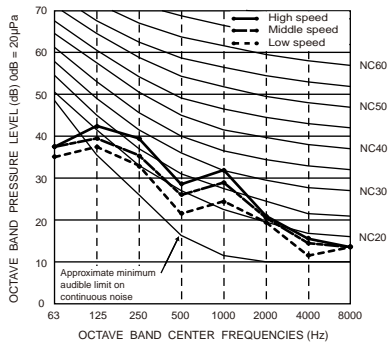

PEFY-WP50VMS1-E

External static pressure : 35Pa
Power source : 220,230,240V, 50/60Hz

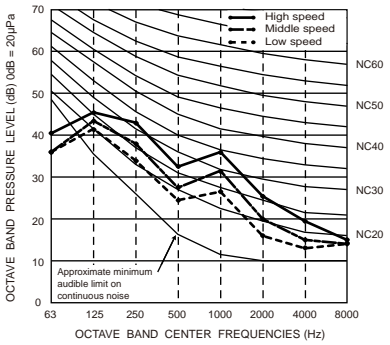

PEFY-WP50VMS1-E

External static pressure : 50Pa
Power source : 220,230,240V, 50/60Hz

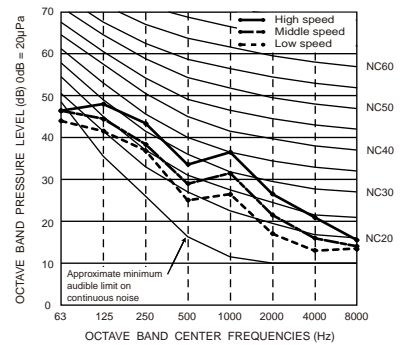

6. FAN CHARACTERISTICS CURVES

PEFY-WP15VMS1-E
 External static pressure : 5Pa
 Power source : 220,230,240V, 50/60Hz
 Suction : Back inlet

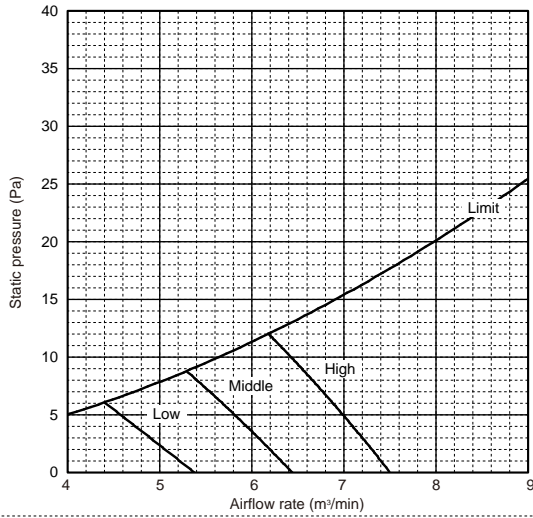

PEFY-WP15VMS1-E
 External static pressure : 15Pa
 Power source : 220,230,240V, 50/60Hz
 Suction : Back inlet

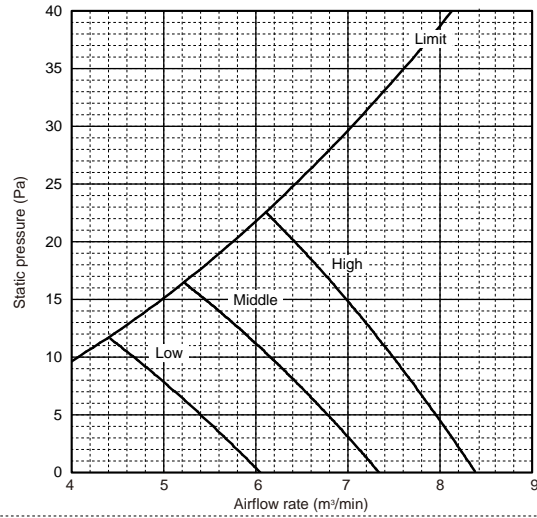

PEFY-WP15VMS1-E
 External static pressure : 35Pa
 Power source : 220,230,240V, 50/60Hz
 Suction : Back inlet

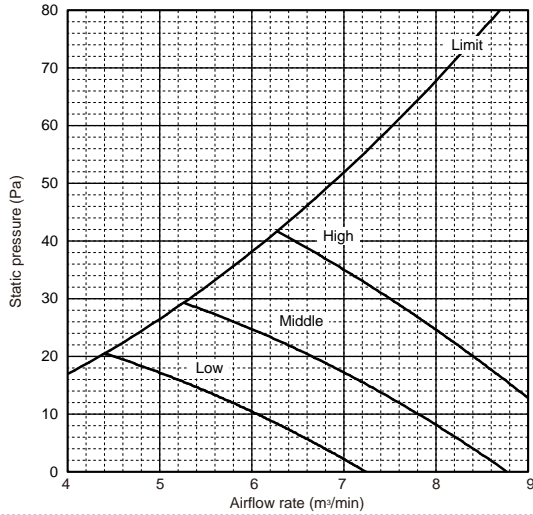

PEFY-WP15VMS1-E
 External static pressure : 50Pa
 Power source : 220,230,240V, 50/60Hz
 Suction : Back inlet

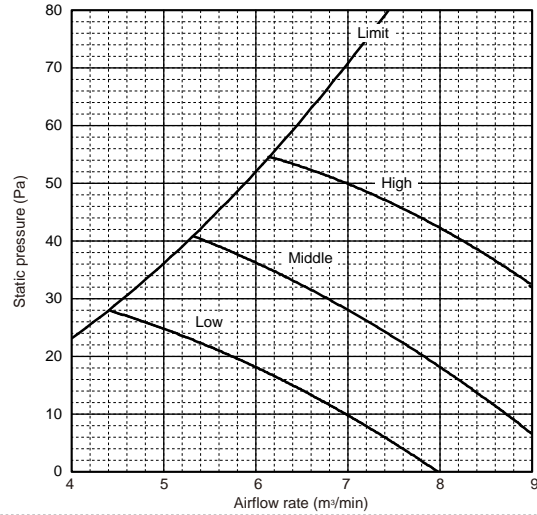

PEFY-WP20VMS1-E
 External static pressure : 5Pa
 Power source : 220,230,240V, 50/60Hz
 Suction : Back inlet

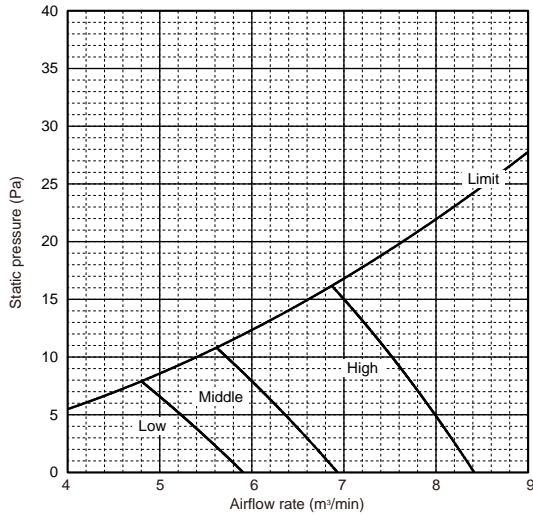

PEFY-WP20VMS1-E
 External static pressure : 15Pa
 Power source : 220,230,240V, 50/60Hz
 Suction : Back inlet

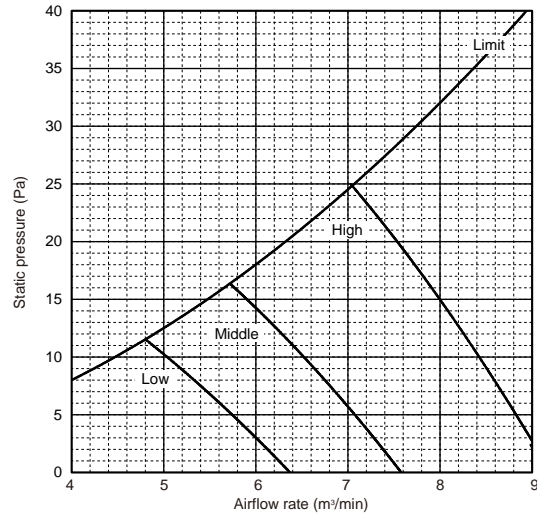

6. FAN CHARACTERISTICS CURVES

PEFY

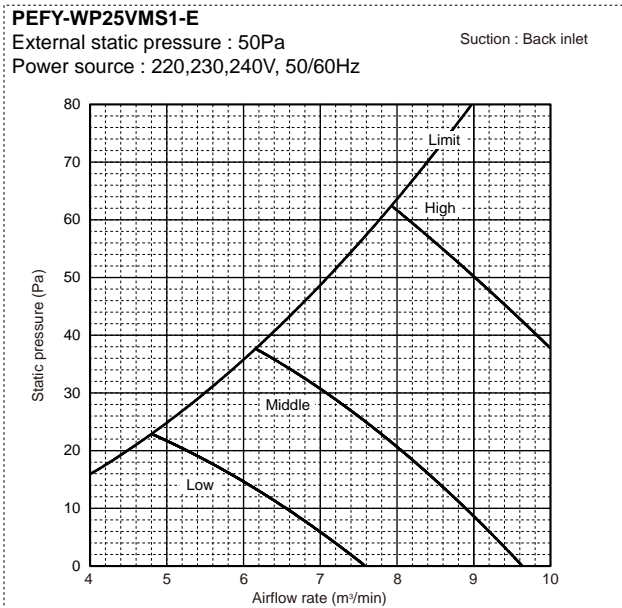
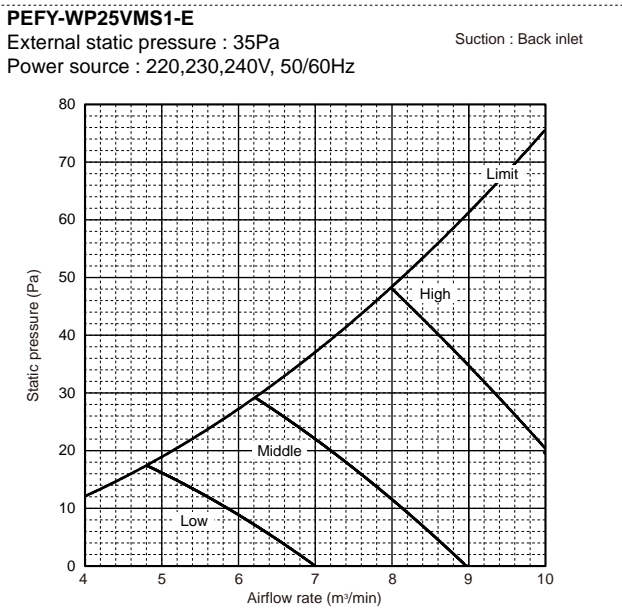
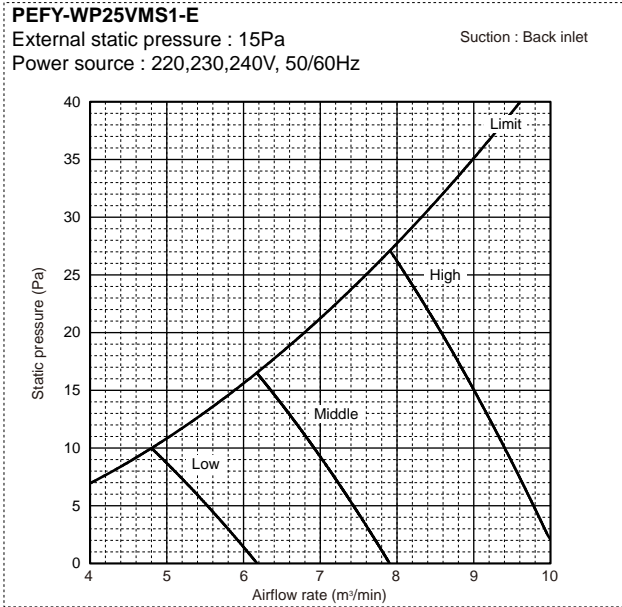
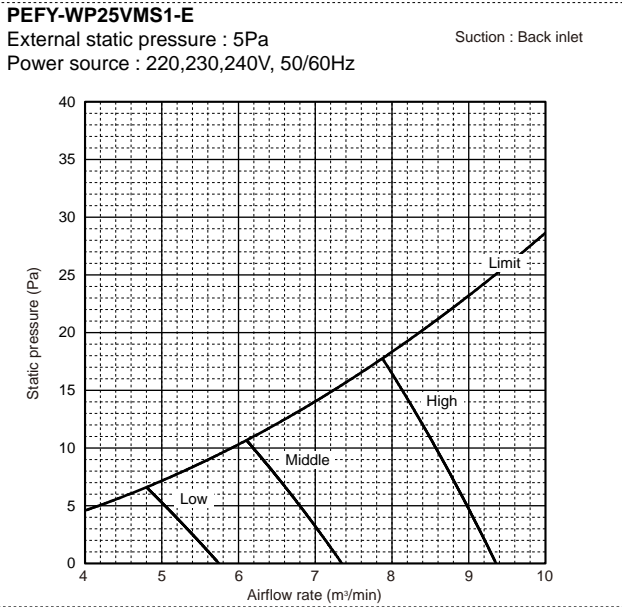
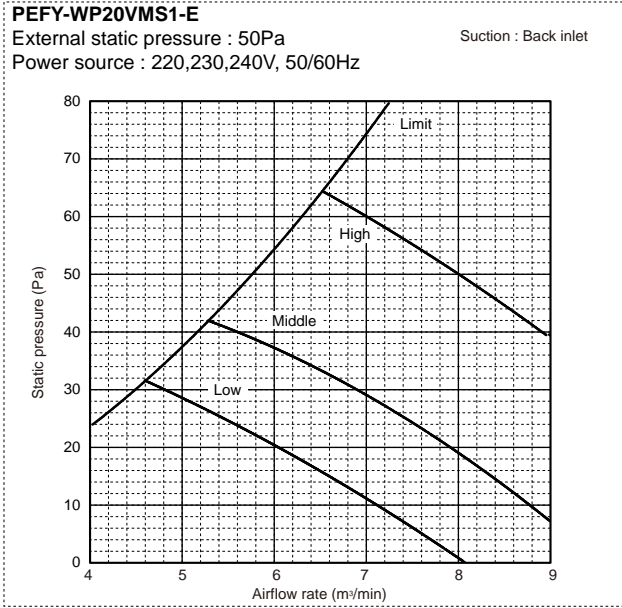
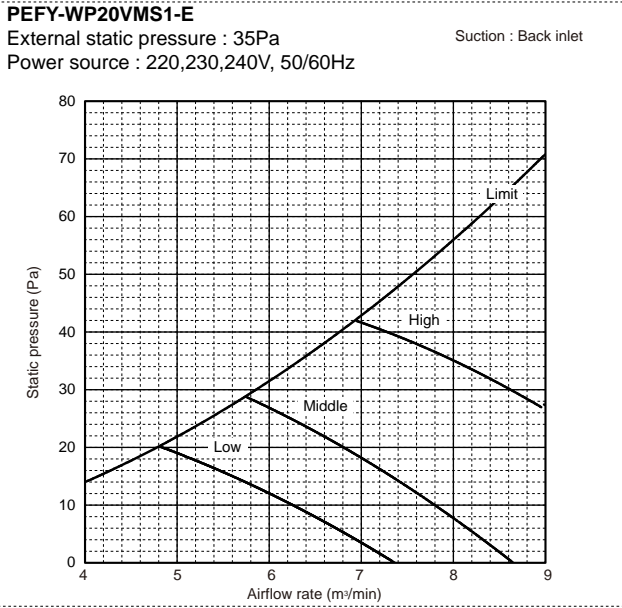

6. FAN CHARACTERISTICS CURVES

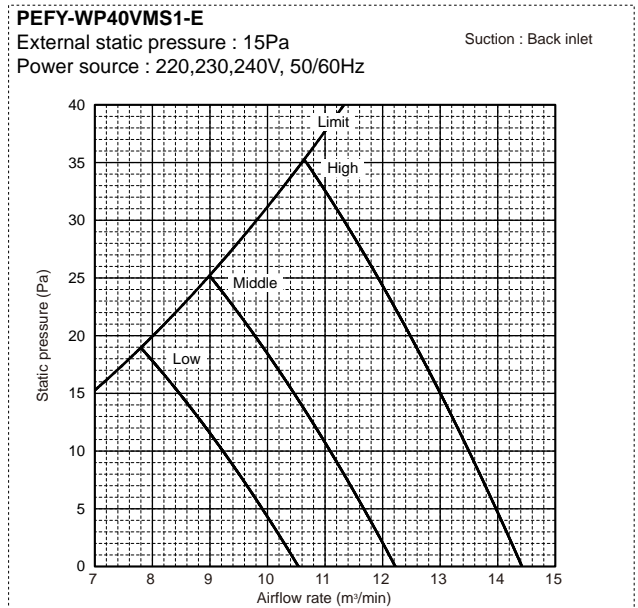
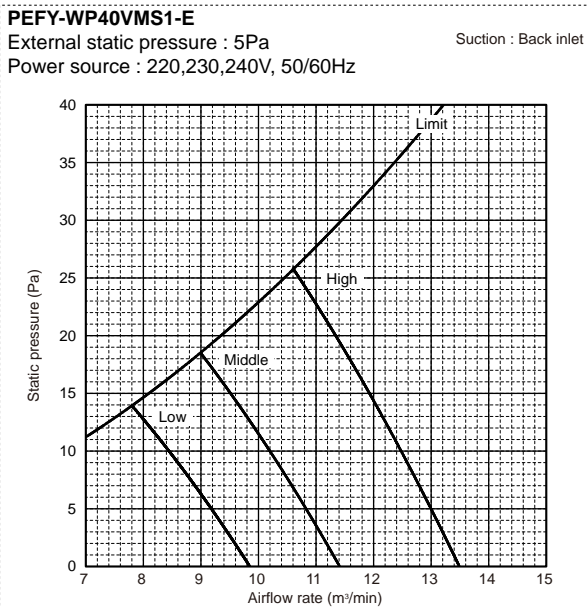
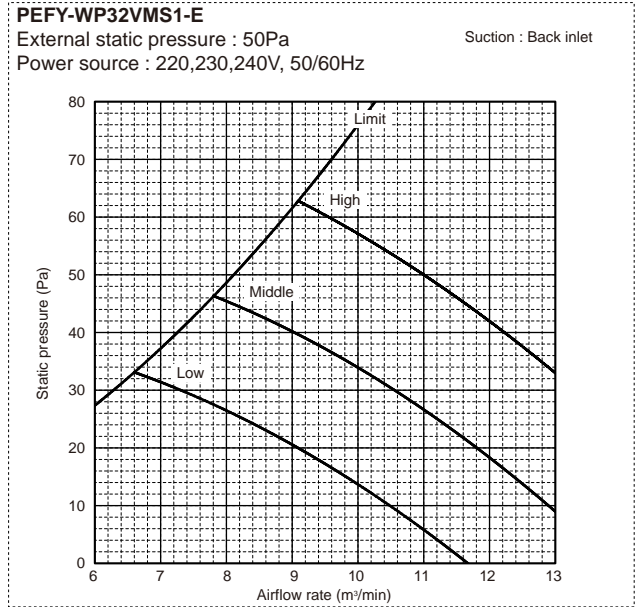
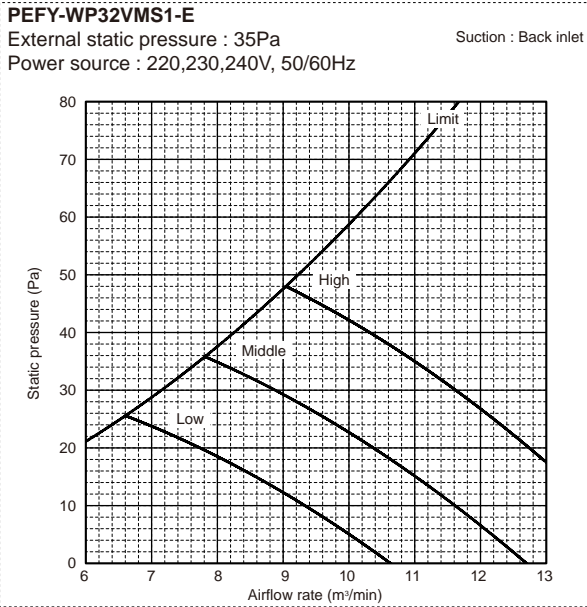
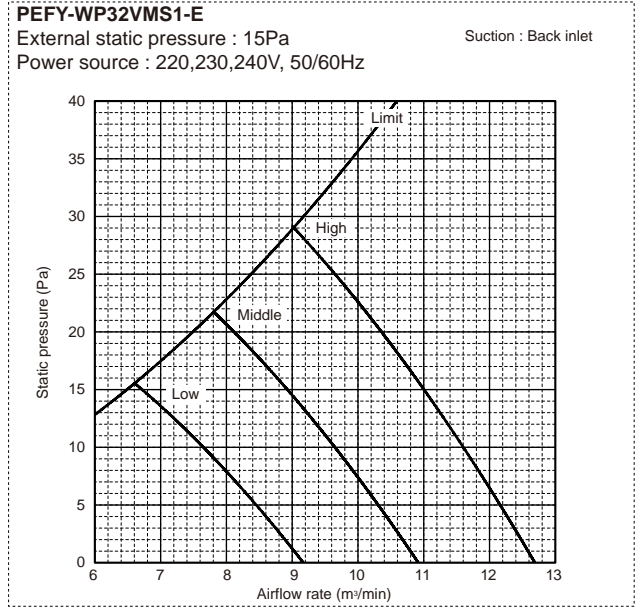
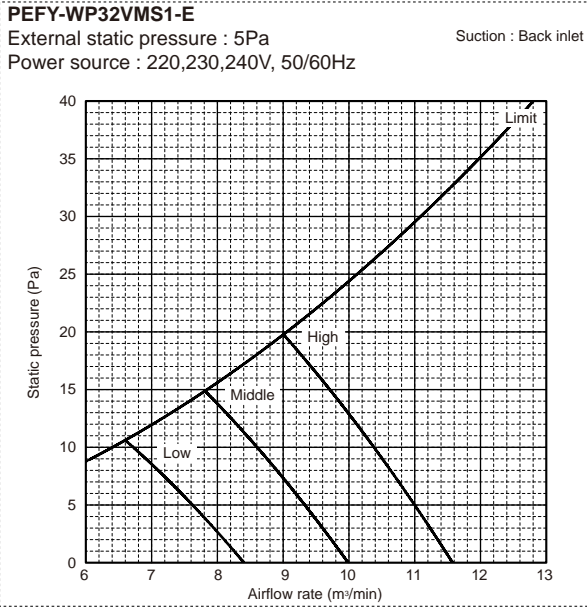

6. FAN CHARACTERISTICS CURVES

PEFY

PEFY-WP40VMS1-E
 External static pressure : 35Pa
 Power source : 220,230,240V, 50/60Hz
 Suction : Back inlet

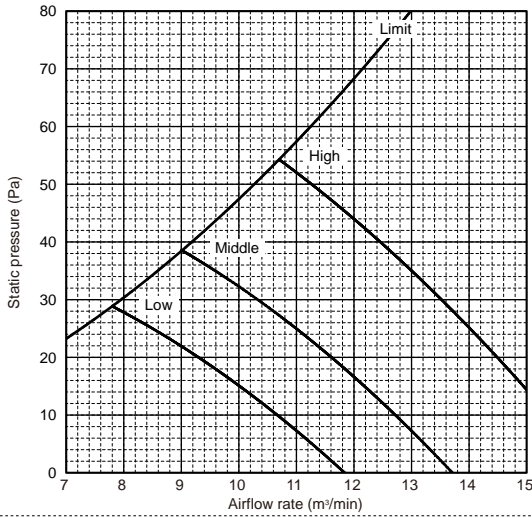

PEFY-WP40VMS1-E
 External static pressure : 50Pa
 Power source : 220,230,240V, 50/60Hz
 Suction : Back inlet

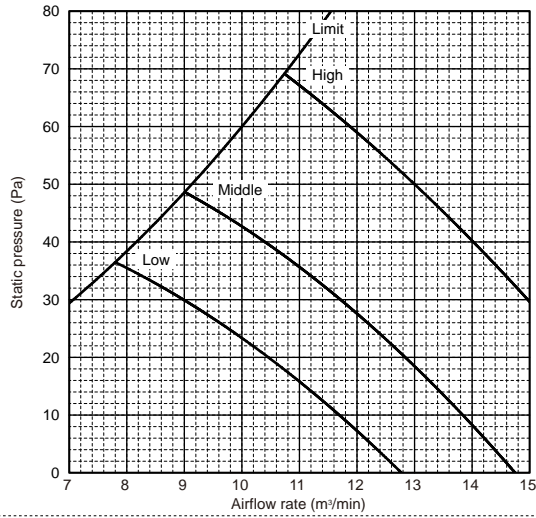

PEFY-WP50VMS1-E
 External static pressure : 5Pa
 Power source : 220,230,240V, 50/60Hz
 Suction : Back inlet

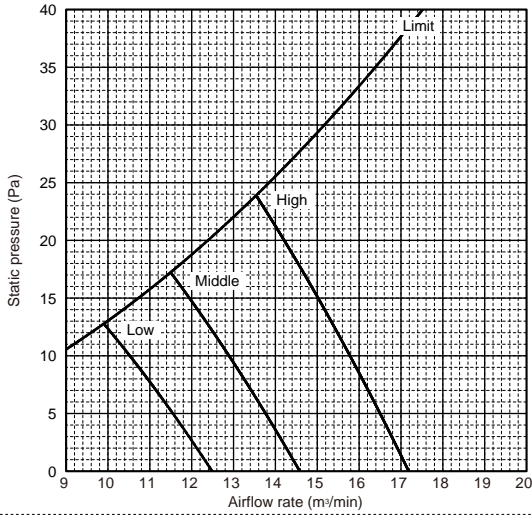

PEFY-WP50VMS1-E
 External static pressure : 15Pa
 Power source : 220,230,240V, 50/60Hz
 Suction : Back inlet

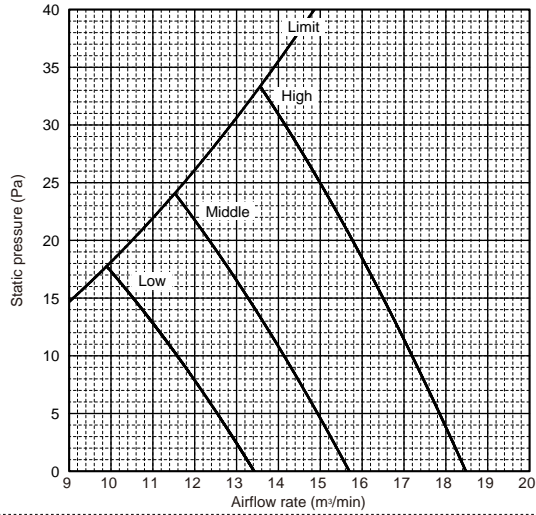

PEFY-WP50VMS1-E
 External static pressure : 35Pa
 Power source : 220,230,240V, 50/60Hz
 Suction : Back inlet

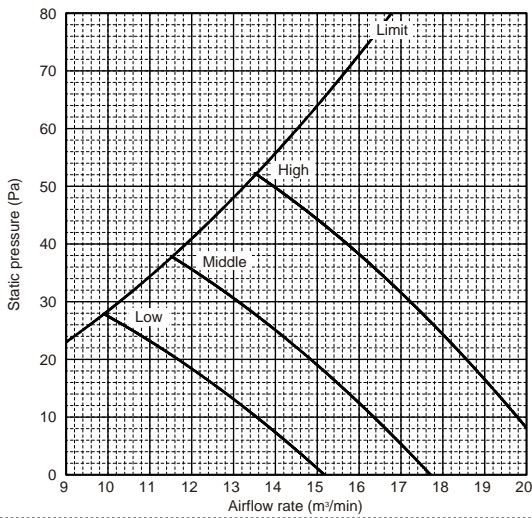

PEFY-WP50VMS1-E
 External static pressure : 50Pa
 Power source : 220,230,240V, 50/60Hz
 Suction : Back inlet

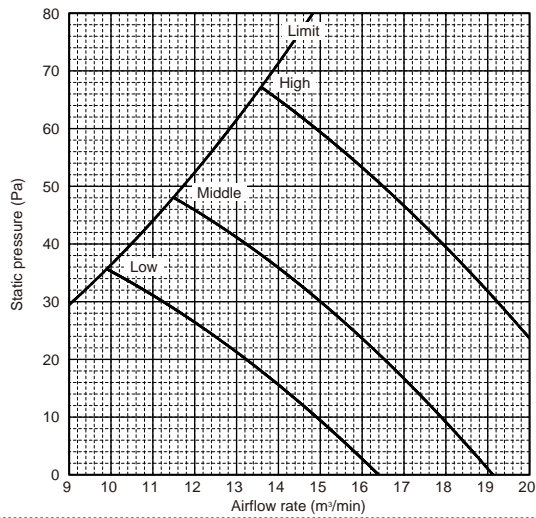

7. OPTIONAL PARTS

7-1. Optional parts line up for the Indoor unit

	Control box replace kit
PEFY-WP15, 20, 25, 32, 40, 50VMS1-E	PAC-KE70HS-E

PEFY



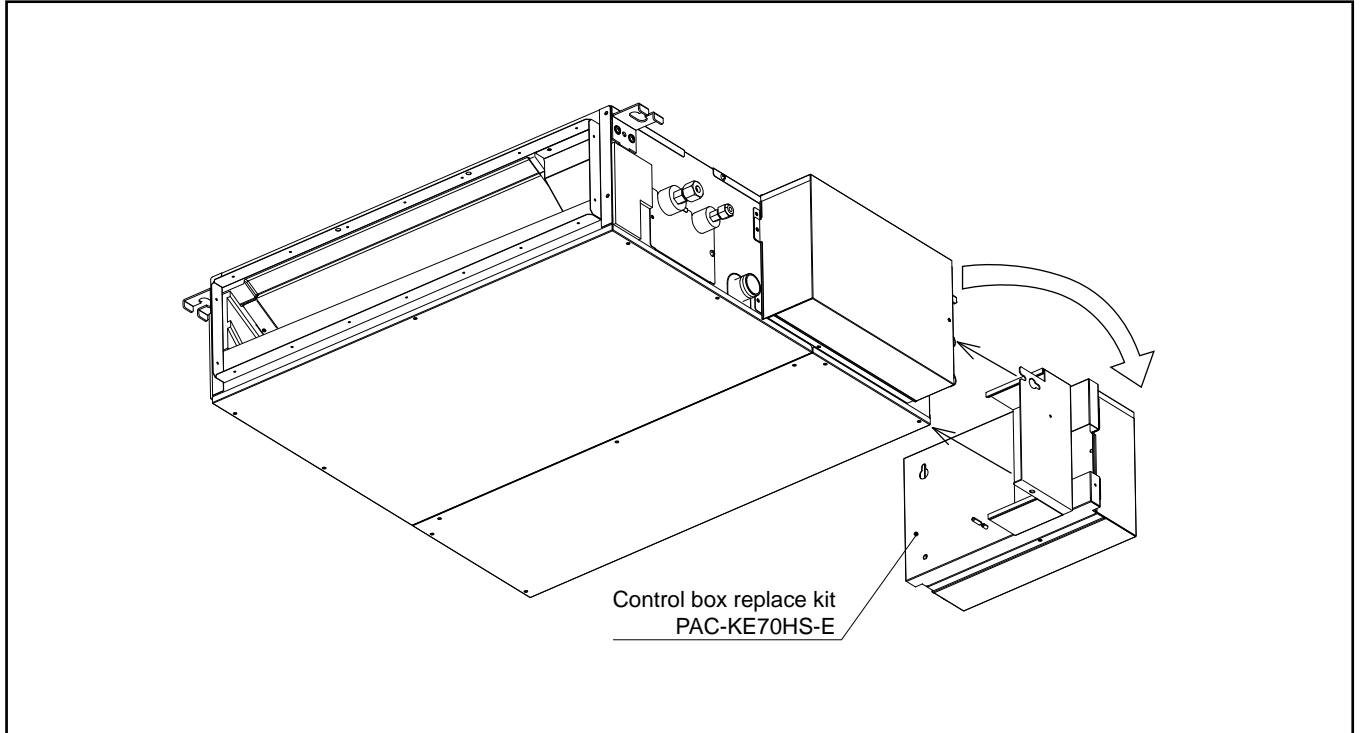







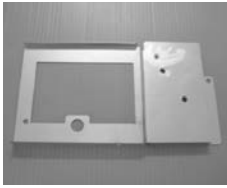
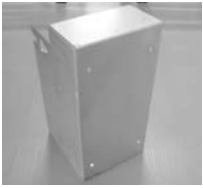
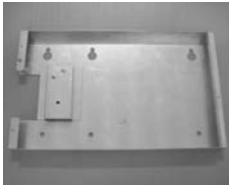
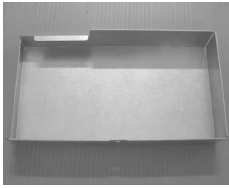





PEFY-WP-VMS1-E

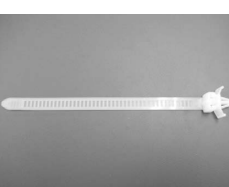

7. OPTIONAL PARTS

7-2. Control box replace kit

PAC-KE70HS-E

Parts	① PLATE A	② PLATE B	③ PLATE C	④ COVER A
Q'ty	1	1	1	1
Shape				
Parts	⑤ COVER B	⑥ LEAD WIRE MOTOR	⑦ LEAD WIRE LEV	⑧ LEAD WIRE THM A
Q'ty	1	1	1	1
Shape		 White 7-pin connector	 White 6-pin connector	 White 4-pin connector
Parts	⑨ LEAD WIRE THM B	⑩ LEAD WIRE EARTH	⑪ LEAD WIRE PUMP	⑫ LEAD WIRE FS
Q'ty	1	1	1	1
Shape	 Red 2-pin connector	 Ring terminal on both ends	 Blue 3-pin connector	 White 4-pin connector
Parts	⑬ INSULATOR	⑭ Connecting terminals	⑮ BAND	⑯ CLAMP
Q'ty	3	4	6	4
Shape				
Parts	⑰ SCREW 1	⑱ SCREW 2	⑲ SCREW 3	⑳ FERRITE CORE
Q'ty	2	4	5	1
Shape	 4X10	 4X10 with a washer	 5X10 with a washer	

When installing the control box replace kit on the air inlet on the unit, ⑫ LEAD WIRE FS is not used.

Ceiling concealed (Middle static pressure type)

PEFY-WP-VMA-E

1. SPECIFICATIONS	1 - 20
2. EXTERNAL DIMENSIONS	1 - 22
3. CENTER OF GRAVITY	1 - 24
4. ELECTRICAL WIRING DIAGRAMS	1 - 25
5. SOUND LEVELS	1 - 26
5-1. Sound levels	1 - 26
5-2. NC curves	1 - 27
6. FAN CHARACTERISTICS CURVES.....	1 - 31
7. OPTIONAL PARTS.....	1 - 35
7-1. Optional parts line up for the Indoor unit.....	1 - 35
7-2. Filter box	1 - 35

1. SPECIFICATIONS

PEFY-VMA

Model		PEFY-WP20VMA-E	PEFY-WP25VMA-E	PEFY-WP32VMA-E	PEFY-WP40VMA-E		
Power source		1-phase 220-230-240 V 50/60 Hz	1-phase 220-230-240 V 50/60 Hz	1-phase 220-230-240 V 50/60 Hz	1-phase 220-230-240 V 50/60 Hz		
Cooling capacity (Nominal)	*1	kW	2.2	2.8	3.6		
	*1	kcal/h	1,900	2,400	3,100		
	*1	BTU/h	7,500	9,600	12,300		
	*2	Power input	kW	0.07	0.09	0.11	
	*2	Current input	A	0.55	0.64	0.74	1.15
Heating capacity (Nominal)	*3	kW	2.5	3.2	4.0	5.0	
	*3	kcal/h	2,200	2,800	3,400	4,300	
	*3	BTU/h	8,500	10,900	13,600	17,100	
	*2	Power input	kW	0.05	0.07	0.09	0.12
	*2	Current input	A	0.44	0.53	0.63	1.04
External finish		Galvanized steel plate	Galvanized steel plate	Galvanized steel plate	Galvanized steel plate		
External dimension HxWxD		mm 250 x 700 x 732	250 x 900 x 732	250 x 900 x 732	250 x 1,100 x 732		
		in. 9-7/8 x 27-9/16 x 28-7/8	9-7/8 x 35-7/16 x 28-7/8	9-7/8 x 35-7/16 x 28-7/8	9-7/8 x 43-5/16 x 28-7/8		
Net weight		kg (lbs) 21 (47)	26 (58)	26 (58)	31 (69)		
Heat exchanger		Cross fin (Aluminum fin and copper tube)	Cross fin (Aluminum fin and copper tube)	Cross fin (Aluminum fin and copper tube)	Cross fin (Aluminum fin and copper tube)		
Water Volume		L	0.7	1.0	1.0		
FAN		Sirocco fan x 1					
Type x Quantity		Sirocco fan x 1					
*4	External static press.	Pa	<35> - 50 - <70> - <100> - <150>	<35> - 50 - <70> - <100> - <150>	<35> - 50 - <70> - <100> - <150>	<35> - 50 - <70> - <100> - <150>	
		mmH ₂ O	<3.6> - 5.1 - <7.1> - <10.2> - <15.3>	<3.6> - 5.1 - <7.1> - <10.2> - <15.3>	<3.6> - 5.1 - <7.1> - <10.2> - <15.3>	<3.6> - 5.1 - <7.1> - <10.2> - <15.3>	
Motor Type		DC motor					
Motor output		kW	0.085	0.085	0.085	0.121	
Driving mechanism		Direct-driven by motor					
Air flow rate		(Low-Mid-High)					
		m ³ /min	7.5 - 9.0 - 10.5	10.0 - 12.0 - 14.0	12.0 - 14.5 - 17.0	14.5 - 18.0 - 21.0	
		L/s	125 - 150 - 175	167 - 200 - 233	200 - 242 - 283	242 - 300 - 350	
		cfm	265 - 318 - 371	353 - 424 - 494	424 - 512 - 600	512 - 636 - 742	
Sound pressure level (measured in anechoic room)		(Low-Mid-High)					
*2		dB <A>	23-26-29	23-27-30	25-29-32	26-29-34	
Insulation material		EPS, Polyethylene foam, Urethane foam					
Air filter		PP honeycomb fabric.					
Protection device		Fuse					
Refrigerant control device		-					
Connectable outdoor unit/HBC controller		CITY MULTI YLM series/ CMB-WP-V-GA1, CMB-WP-V-GB1					
Diameter of water pipe	*5	Inlet	in. Rc 3/4 screw	Rc 3/4 screw	Rc 3/4 screw	Rc 3/4 screw	
	*6	Outlet	in. Rc 3/4 screw	Rc 3/4 screw	Rc 3/4 screw	Rc 3/4 screw	
Field drain pipe size		mm (in.)	O.D.32 (1-1/4)	O.D.32 (1-1/4)	O.D.32 (1-1/4)	O.D.32 (1-1/4)	
Drawing	External		KD94L918X01	KD94L918X01	KD94L918X01	KD94L918X01	
	Wiring		KD94L919X01	KD94L919X01	KD94L919X01	KD94L919X01	
	Refrigerant cycle		-	-	-	-	
Standard attachment	Document		Installation Manual, Instruction Book	Installation Manual, Instruction Book	Installation Manual, Instruction Book	Installation Manual, Instruction Book	
	Accessory		Insulation pipe for water pipe, Washer, Drain hose, Tie band	Insulation pipe for water pipe, Washer, Drain hose, Tie band	Insulation pipe for water pipe, Washer, Drain hose, Tie band	Insulation pipe for water pipe, Washer, Drain hose, Tie band	
Optional parts	Filter box		PAC-KE91TB-E	PAC-KE92TB-E	PAC-KE92TB-E	PAC-KE93TB-E	
Remarks		* Details on foundation work, duct work, insulation work, electrical wiring, power source switch, and other items shall be referred to the Installation Manual. * Due to continuing improvement, above specifications may be subject to change without notice.					

Notes:	Unit converter
1.Nominal cooling conditions Indoor: 27°C.D.B./19°C.W.B. (81°C.D.B./66°C.W.B.), Outdoor: 35°C.D.B. (95°C.D.B.) Pipe length: 7.5 m (24-9/16 ft.), Level difference: 0 m (0 ft.)	kcal/h =kW x 860
2.The values are measured at the factory setting of external static pressure.	BTU/h =kW x 3,412
3.Nominal heating conditions Indoor: 20°C.D.B. (68°C.D.B.), Outdoor: 7°C.D.B./6°C.W.B. (45°C.D.B./43°C.W.B.) Pipe length: 7.5 m (24-9/16 ft.), Level difference: 0 m (0 ft.)	cfm =m ³ /min x 35.31
4.The factory setting of external static pressure is shown without < > . Refer to "Fan characteristics curves", according to the external static pressure, in DATA BOOK for the usable range of air flow rate.	lbs =kg / 0.4536
5.Be sure to install a valve on the water outlet.	
6.Install a strainer (40 mesh or more) on the pipe next to the valve to remove the foreign matters.	*Above specification data is subject to rounding variation.
7.Group units that operate on 1 branch.	

1. SPECIFICATIONS

Model			PEFY-WP50VMA-E		
Power source			1-phase 220-230-240 V 50/60 Hz		
Cooling capacity (Nominal)	*1	kW	5.6		
	*1	kcal/h	4,800		
	*1	BTU/h	19,100		
	*2	Power input	kW		
	*2	Current input	A		
Heating capacity (Nominal)	*3	kW	6.3		
	*3	kcal/h	5,400		
	*3	BTU/h	21,500		
	*2	Power input	kW		
	*2	Current input	A		
External finish			Galvanized steel plate		
External dimension HxWxD			mm	250 x 1,100 x 732	
			in.	9-7/8 x 43-5/16 x 28-7/8	
Net weight			kg (lbs)	31 (69)	
Heat exchanger			Cross fin (Aluminum fin and copper tube)		
		Water Volume	L	1.8	
FAN			Sirocco fan x 2		
	*4	External static press.	Pa	<35> - 50 - <70> - <100> - <150>	
			mmH ₂ O	<3.6> - 5.1 - <7.1> - <10.2> - <15.3>	
Motor Type			DC motor		
		Motor output	kW	0.121	
Driving mechanism			Direct-driven by motor		
Air flow rate			(Low-Mid-High)		
			m ³ /min	14.5 - 18.0 - 21.0	
			L/s	242 - 300 - 350	
			cfm	512 - 636 - 742	
Sound pressure level (measured in anechoic room)			(Low-Mid-High)		
		*2	dB <A>	26-29-34	
Insulation material			EPS, Polyethylene foam, Urethane foam		
Air filter			PP honeycomb fabric.		
Protection device			Fuse		
Refrigerant control device			-		
Connectable outdoor unit/HBC controller			CITY MULTI YLM series/ CMB-WP-V-GA1, CMB-WP-V-GB1		
Diameter of water pipe	Inlet	in.	Rc 3/4 screw		
	*5 *6	Outlet	in.	Rc 3/4 screw	
Field drain pipe size			mm (in.)	O.D.32 (1-1/4)	
Drawing	External		KD94L918X01		
	Wiring		KD94L919X01		
	Refrigerant cycle		-		
Standard attachment	Document		Installation Manual, Instruction Book		
	Accessory		Insulation pipe for water pipe, Washer, Drain hose, Tie band		
Optional parts	Filter box		PAC-KE93TB-E		
Remarks			* Details on foundation work, duct work, insulation work, electrical wiring, power source switch, and other items shall be referred to the Installation Manual. * Due to continuing improvement, above specifications may be subject to change without notice.		

Notes :	Unit converter
1.Nominal cooling conditions Indoor: 27°C.D.B./19°C.W.B. (81°C.D.B./66°C.W.B.), Outdoor: 35°C.D.B. (95°C.D.B.) Pipe length: 7.5 m (24-9/16 ft.), Level difference: 0 m (0 ft.)	kcal/h =kW x 860 BTU/h =kW x 3,412
2.The values are measured at the factory setting of external static pressure.	cfm =m ³ /min x 35.31
3.Nominal heating conditions Indoor: 20°C.D.B. (68°C.D.B.), Outdoor: 7°C.D.B./6°C.W.B. (45°C.D.B./43°C.W.B.) Pipe length: 7.5 m (24-9/16 ft.), Level difference: 0 m (0 ft.)	lbs =kg / 0.4536
4.The factory setting of external static pressure is shown without < > . Refer to "Fan characteristics curves", according to the external static pressure, in DATA BOOK for the usable range of air flow rate.	
5.Be sure to install a valve on the water outlet.	
6.Install a strainer (40 mesh or more) on the pipe next to the valve to remove the foreign matters.	
7.Group units that operate on 1 branch.	*Above specification data is subject to rounding variation.

2. EXTERNAL DIMENSIONS

PEFY-WP20, 25, 32, 40, 50VMA-E

- Note 1. Use M10 screw for the Suspension bolt (field supply).
 2. Keep the service space for the maintenance at the bottom.
 3. This chart indicates for PEFY-WP40-50VMA-E models, which have 2 fans. PEFY-WP20-25-32VMA-E models have 1 fan.
 4. In case of the inlet duct is used, remove the air filter (supply with the unit), then install the filter (field supply) at suction side.

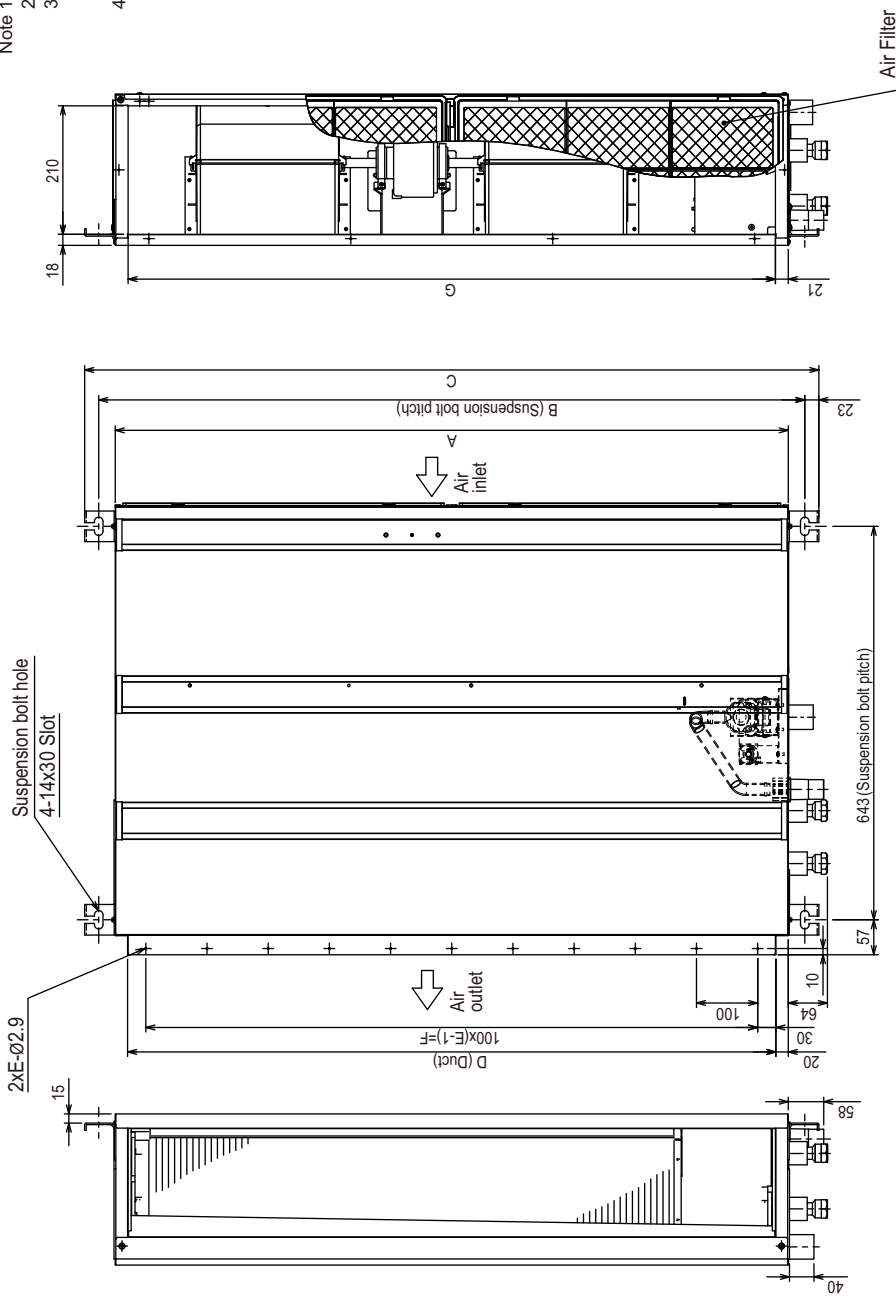

Model	A	B	C	D	E	F	G	① Water pipe	② Water pipe
								(From HBC unit)	(To HBC unit)
PEFY-WP20VMA-E	700	754	800	660	7	600	658	Rc3/4 screw	
PEFY-WP25-32VMA-E	900	954	1000	860	9	800	858		
PEFY-WP40-50VMA-E	1100	1154	1200	1060	11	1000	1058		

Unit : mm

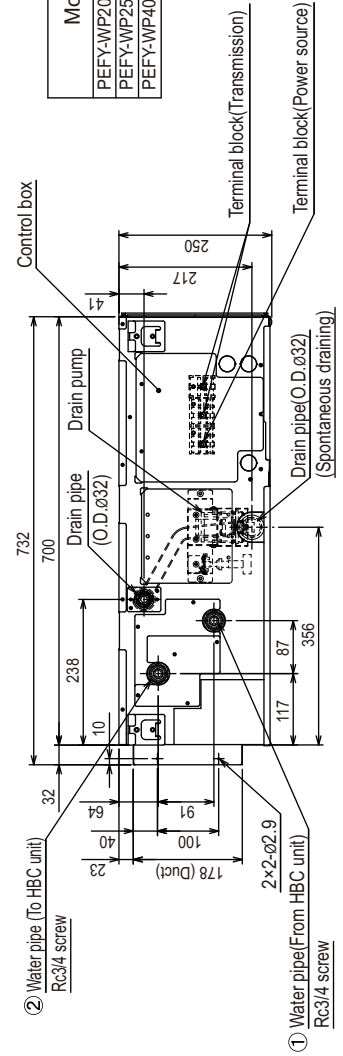

2. EXTERNAL DIMENSIONS

PEFY-WP20, 25, 32, 40, 50VMA-E

Unit : mm

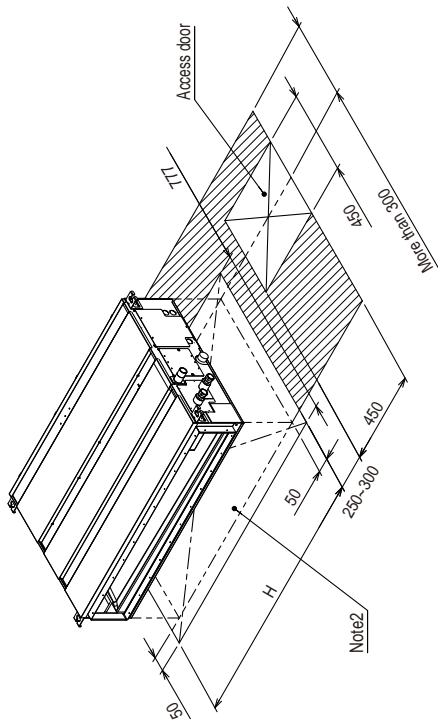
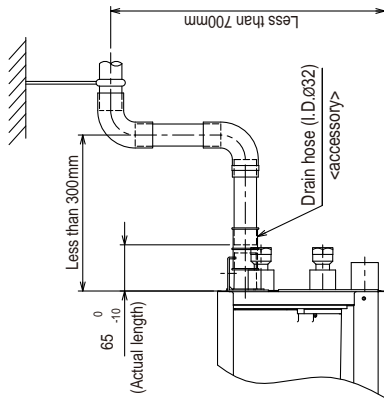

Required space for service and maintenance

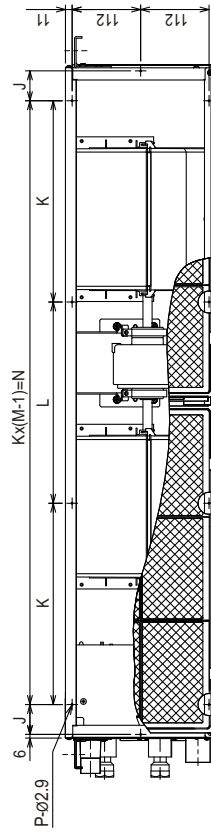

Model	H	J	K	L	M	N	P
PEFY-WP20VMA-E	800	44	150	300			10
PEFY-WP25,32VMA-E	1000	54	260	4	780	10	
PEFY-WP40,50VMA-E	1200	49	330	4	990	10	

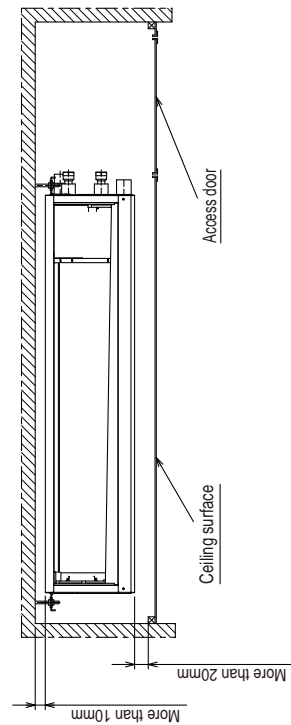

Make the access door at the appointed position for service maintenance.

3. CENTER OF GRAVITY

PEFY-VMA

PEFY-WP20, 25, 32, 40, 50VMA-E

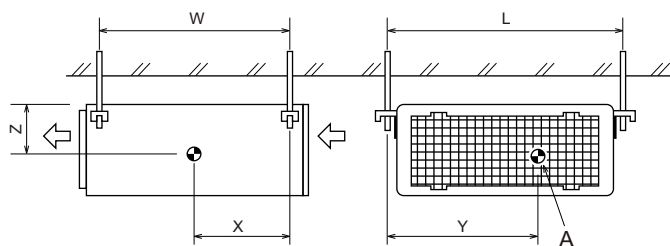

A : Center of gravity

(mm)[in]

Model name	W	L	X	Y	Z
PEFY-WP20VMA-E	643 [25 - 6/16]	754 [29 - 11/16]	330 [13]	300 [11 - 13/16]	130 [5 - 2/16]
PEFY-WP25VMA-E	643 [25 - 6/16]	954 [37 - 9/16]	340 [13 - 7/16]	375 [14 - 13/16]	130 [5 - 2/16]
PEFY-WP32VMA-E	643 [25 - 6/16]	954 [37 - 9/16]	340 [13 - 7/16]	375 [14 - 13/16]	130 [5 - 2/16]
PEFY-WP40VMA-E	643 [25 - 6/16]	1154 [45 - 7/16]	325 [12 - 13/16]	525 [20 - 11/16]	130 [5 - 2/16]
PEFY-WP50VMA-E	643 [25 - 6/16]	1154 [45 - 7/16]	325 [12 - 13/16]	525 [20 - 11/16]	130 [5 - 2/16]

4. ELECTRICAL WIRING DIAGRAMS

PEFY-WP20, 25, 32, 40, 50VMA-E

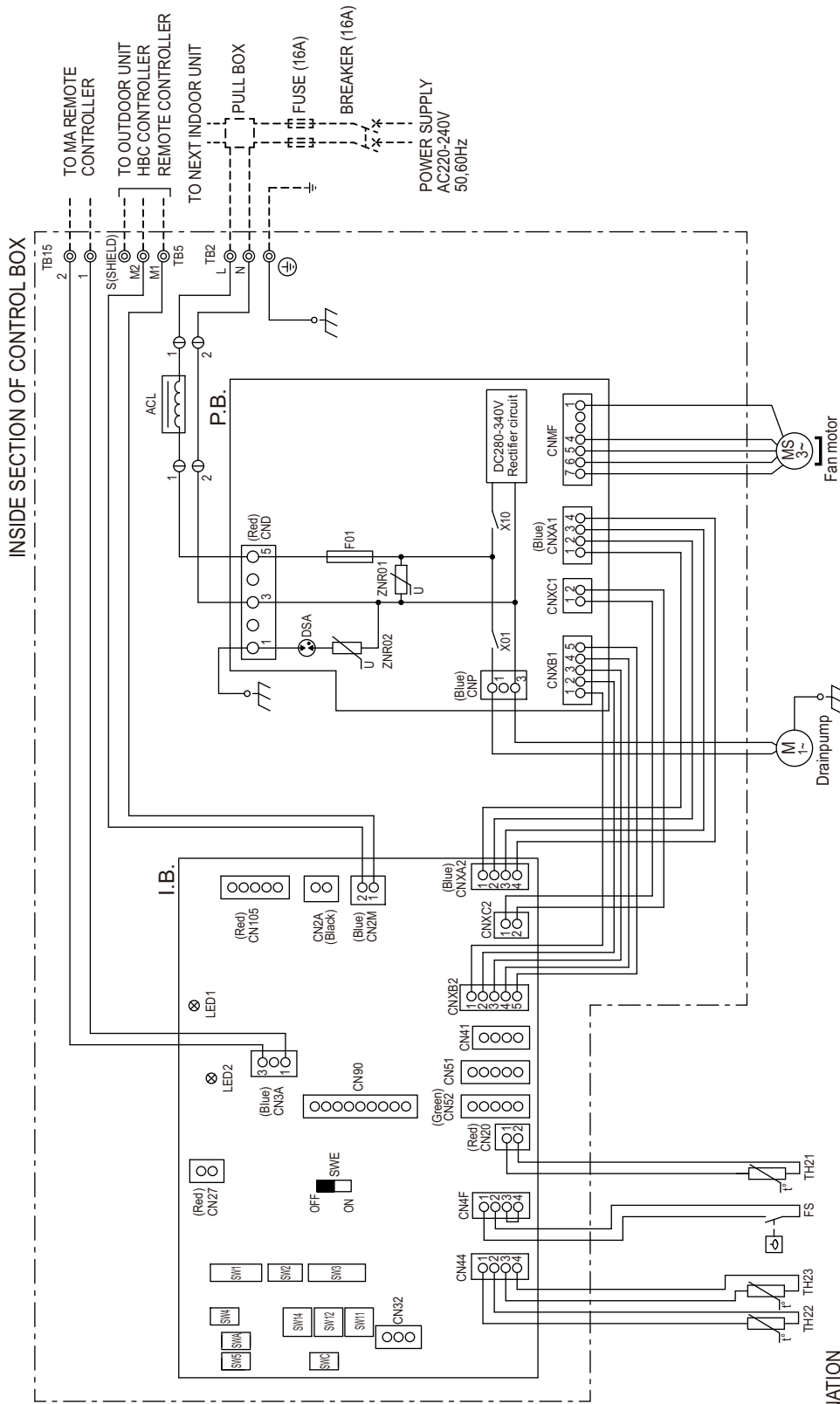

NOTE: Symbols used in wiring diagram above are,
 ⊕ : Connector
 ⊙ : Terminal
 ----- (Heavy dotted line): Field wiring

SYMBOL EXPLANATION

SYMBOL	NAME	SYMBOL	NAME	SYMBOL	NAME
I.B.	Indoor controller board	CN41	Connector (HA terminal-A)	SW4(LB.)	Switch (for model selection)
P.B.	Power supply board	CN51	Connector (Centrally control)	SW5(LB.)	Switch (for mode selection)
TB2	Power source terminal block	CN52	Connector (Remote indication)	SW11(LB.)	Switch (1s digit address set)
TB5	Transmission terminal block	CN90	Connector (Wireless)	SW12(LB.)	Switch (10ths digit address set)
TB15	Transmission terminal block	CN105	Connector (IT terminal)	SW14(LB.)	Switch (BRANCH No.)
F01	Fuse AC250V 6.3A	CN2A	Connector (0-10V Analog input)	SWA(LB.)	Switch (for static pressure selection)
ZNR01,02	Varistor	FS	Float switch	SWC(LB.)	Switch (for static pressure selection)
DSA	Arrester	TH21	Thermistor (inlet air temp. detection)	SWE(LB.)	Connector (emergency operation)
X01	Aux. relay	TH22	Thermistor (piping temp. detection/water in)	LED1	LED(Power supply)
X10	Aux. relay	TH23	Thermistor (piping temp. detection/water out)	LED2	LED(Remote controller supply)
ACL	AC reactor(Power factor improvement)	SW1(LB.)	Switch (for mode selection)		
CN27	Connector (Damper)	SW2(LB.)	Switch (for capacity code)		
CN32	Connector (Remote switch)	SW3(LB.)	Switch (for mode selection)		

5. SOUND LEVELS

5-1. Sound levels

5-1-1. Sound levels (Measured condition : With 1m air inlet duct and 2m air outlet duct)

PEFY-VMA

PEFY-WP-VMA-E

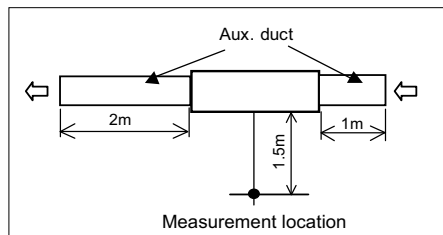

* Measured in anechoic room.

Sound level at anechoic room : Low-Mid-High

Model	Sound level dB(A)				
	35Pa	50Pa	70Pa	100Pa	150Pa
PEFY-WP20VMA-E	28-30-34	28-30-34	29-32-36	29-33-37	31-35-40
PEFY-WP25VMA-E	28-30-34	28-30-34	29-32-36	29-33-37	32-36-40
PEFY-WP32VMA-E	28-31-35	28-32-35	29-33-37	30-34-38	32-37-41
PEFY-WP40VMA-E	30-33-37	30-34-38	31-36-39	33-37-41	36-41-44
PEFY-WP50VMA-E	30-33-37	30-34-38	31-36-39	33-37-41	36-41-44

5-1-2. Sound levels (Measured condition : With 2m air inlet duct and 2m air outlet duct)

PEFY-WP-VMA-E

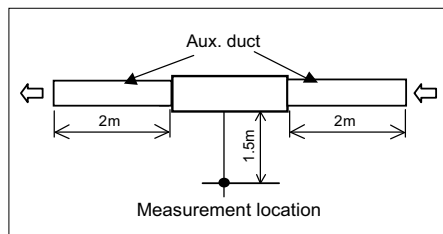

* Measured in anechoic room.

Sound level at anechoic room : Low-Mid-High

Model	Sound level dB(A)				
	35Pa	50Pa	70Pa	100Pa	150Pa
PEFY-WP20VMA-E	23-25-28	23-26-29	24-27-30	25-28-32	28-32-36
PEFY-WP25VMA-E	23-26-29	23-27-30	24-28-31	26-29-33	29-33-37
PEFY-WP32VMA-E	24-28-31	25-29-32	26-30-33	27-31-34	29-34-38
PEFY-WP40VMA-E	26-29-33	26-29-34	26-30-35	29-33-37	32-37-41
PEFY-WP50VMA-E	26-29-33	26-29-34	26-30-35	29-33-37	32-37-41

5. SOUND LEVELS

5-2. NC curves

5-2-1. NC curves (Sound level measured condition : With 1m air inlet duct and 2m air outlet duct)

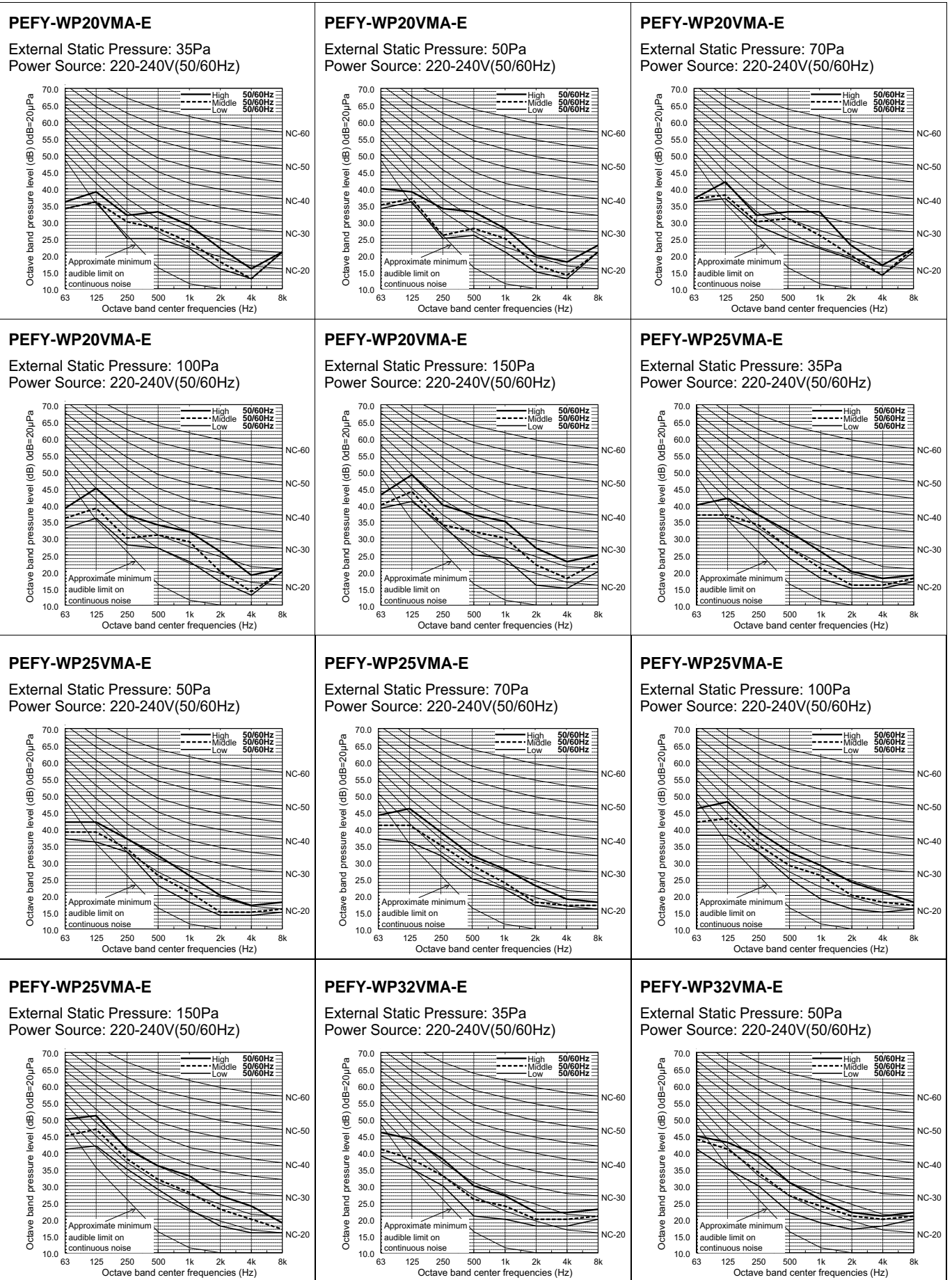

5. SOUND LEVELS

PEFY-VMA

PEFY-WP32VMA-E

External Static Pressure: 70Pa
Power Source: 220-240V(50/60Hz)

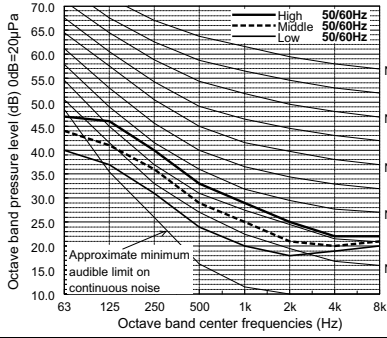

PEFY-WP32VMA-E

External Static Pressure: 100Pa
Power Source: 220-240V(50/60Hz)

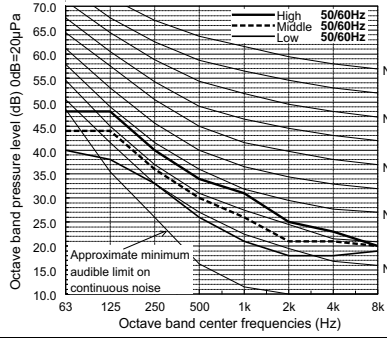

PEFY-WP32VMA-E

External Static Pressure: 150Pa
Power Source: 220-240V(50/60Hz)

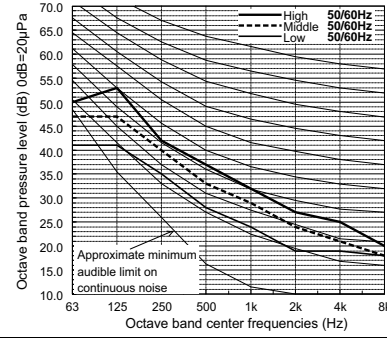

PEFY-WP40,50VMA-E

External Static Pressure: 35Pa
Power Source: 220-240V(50/60Hz)

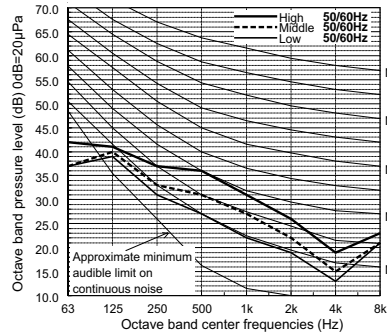

PEFY-WP40,50VMA-E

External Static Pressure: 50Pa
Power Source: 220-240V(50/60Hz)

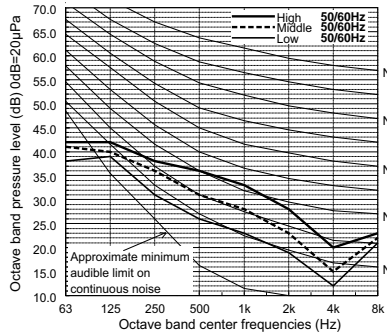

PEFY-WP40,50VMA-E

External Static Pressure: 70Pa
Power Source: 220-240V(50/60Hz)

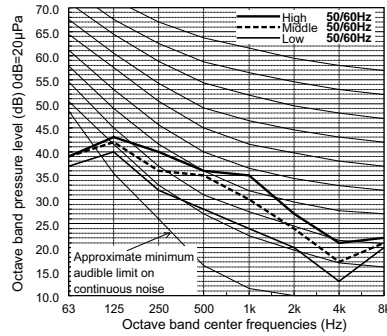

PEFY-WP40,50VMA-E

External Static Pressure: 100Pa
Power Source: 220-240V(50/60Hz)

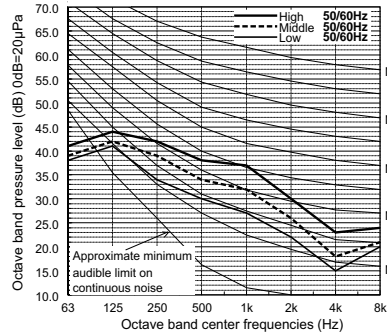

PEFY-WP40,50VMA-E

External Static Pressure: 150Pa
Power Source: 220-240V(50/60Hz)

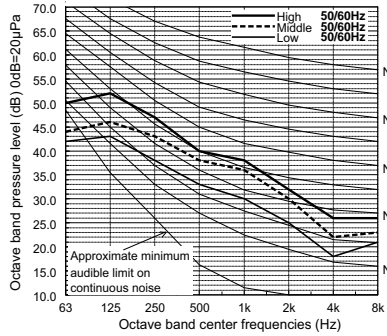

5. SOUND LEVELS

5-2.2. NC curves (Sound level measured condition : With 2m air inlet duct and 2m air outlet duct)

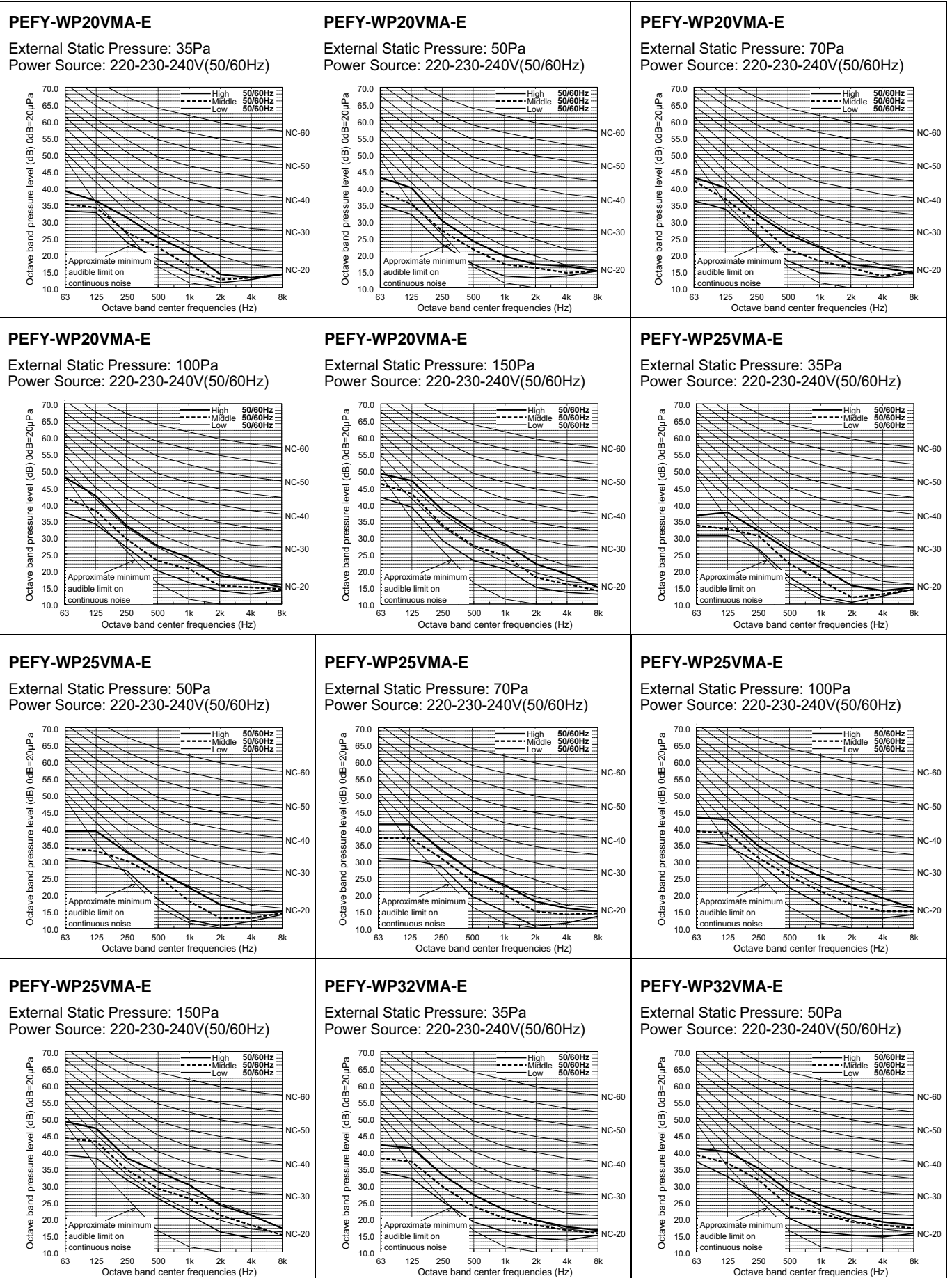

5. SOUND LEVELS

PEFY-VMA

PEFY-WP32VMA-E

External Static Pressure: 70Pa
Power Source: 220-230-240V(50/60Hz)

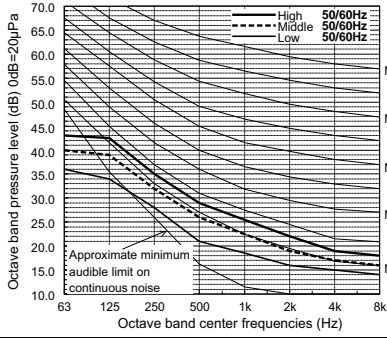

PEFY-WP32VMA-E

External Static Pressure: 100Pa
Power Source: 220-230-240V(50/60Hz)

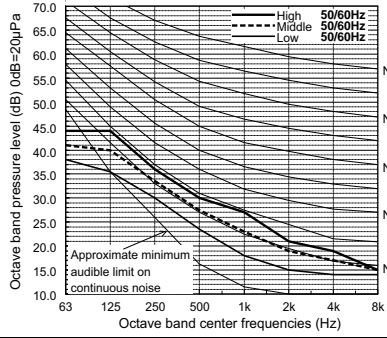

PEFY-WP32VMA-E

External Static Pressure: 150Pa
Power Source: 220-230-240V(50/60Hz)

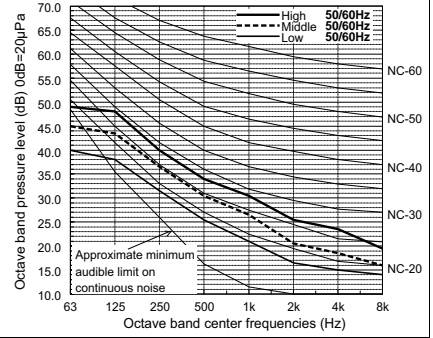

PEFY-WP40, 50VMA-E

External Static Pressure: 35Pa
Power Source: 220-230-240V(50/60Hz)

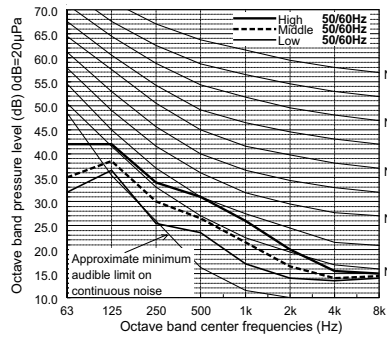

PEFY-WP40, 50VMA-E

External Static Pressure: 50Pa
Power Source: 220-230-240V(50/60Hz)

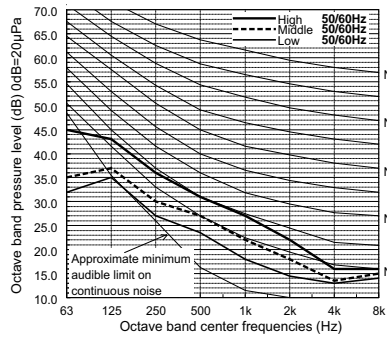

PEFY-WP40, 50VMA-E

External Static Pressure: 70Pa
Power Source: 220-230-240V(50/60Hz)

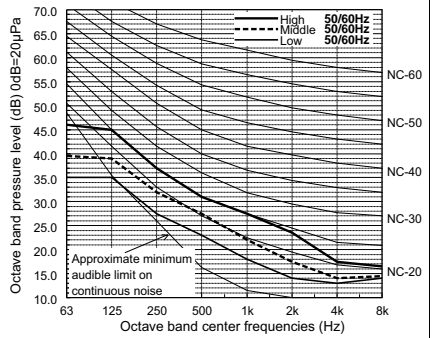

PEFY-WP40, 50VMA-E

External Static Pressure: 100Pa
Power Source: 220-230-240V(50/60Hz)

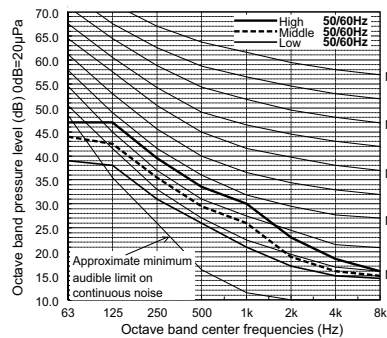

PEFY-WP40, 50VMA-E

External Static Pressure: 150Pa
Power Source: 220-230-240V(50/60Hz)

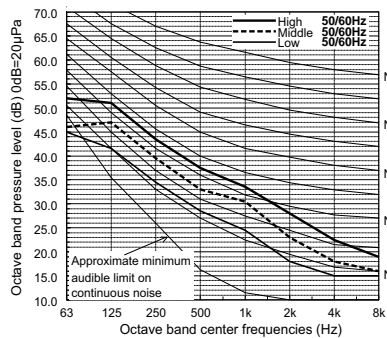

6. FAN CHARACTERISTICS CURVES

PEFY-WP20VMA-E

External static pressure : 35Pa
Power source : 220-240V

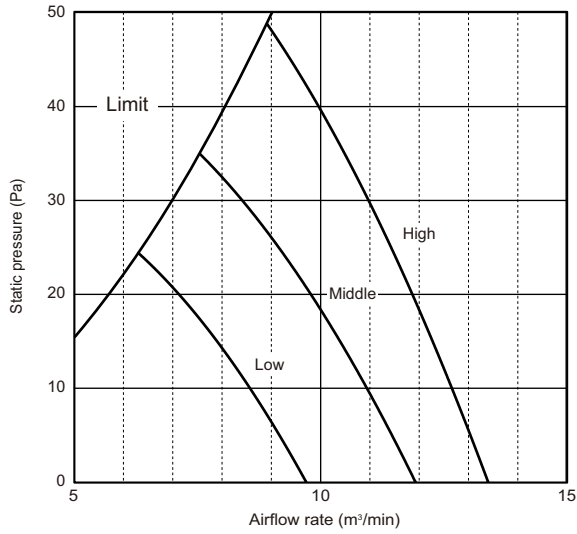

PEFY-WP20VMA-E

External static pressure : 50Pa
Power source : 220-240V

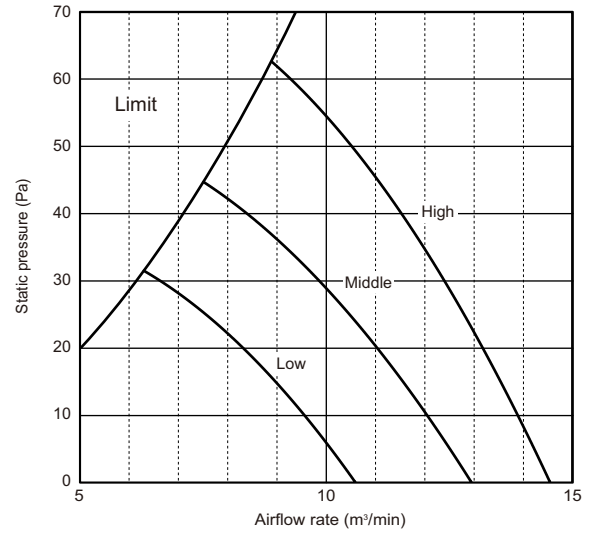

PEFY-WP20VMA-E

External static pressure : 70Pa
Power source : 220-240V

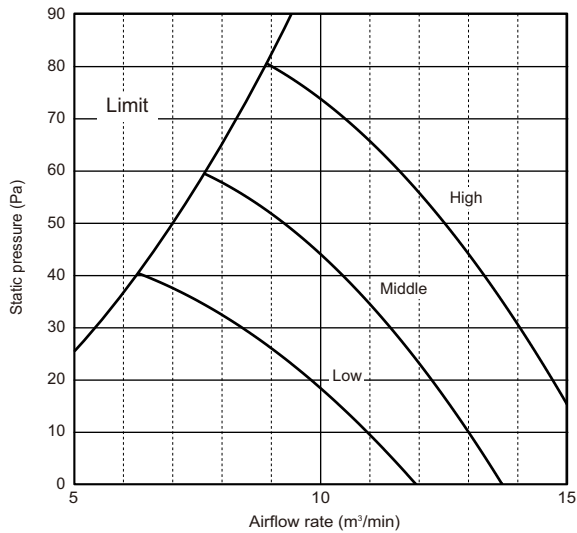

PEFY-WP20VMA-E

External static pressure : 100Pa
Power source : 220-240V

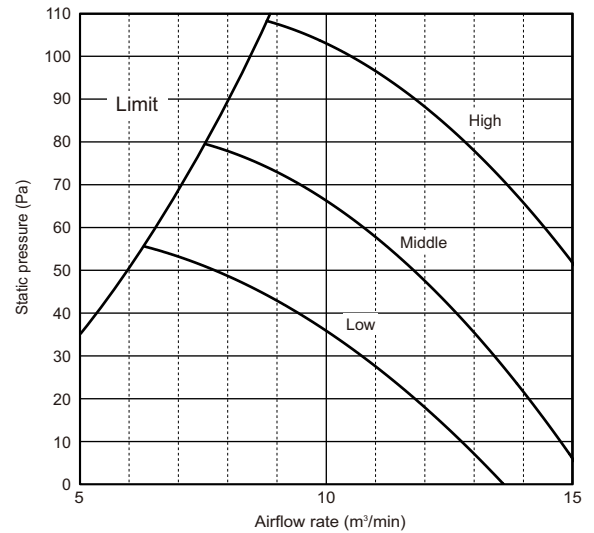

PEFY-WP20VMA-E

External static pressure : 150Pa
Power source : 220-240V

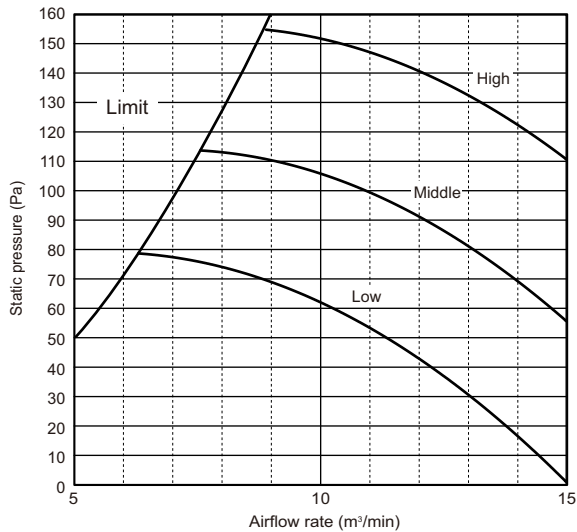

6. FAN CHARACTERISTICS CURVES

PEFY-VMA

PEFY-WP25VMA-E

External static pressure : 35Pa
Power source : 220-240V

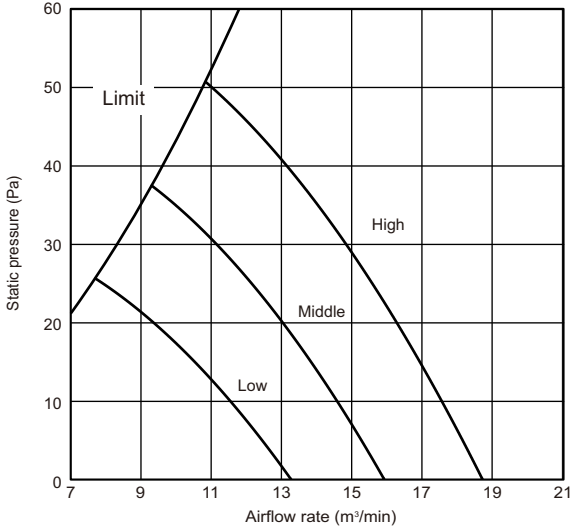

PEFY-WP25VMA-E

External static pressure : 50Pa
Power source : 220-240V

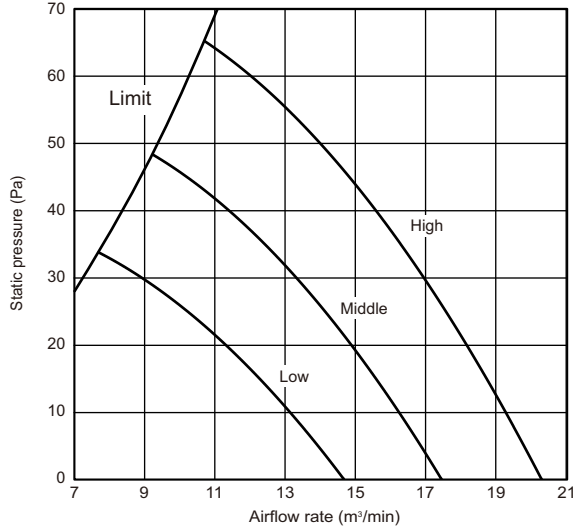

PEFY-WP25VMA-E

External static pressure : 70Pa
Power source : 220-240V

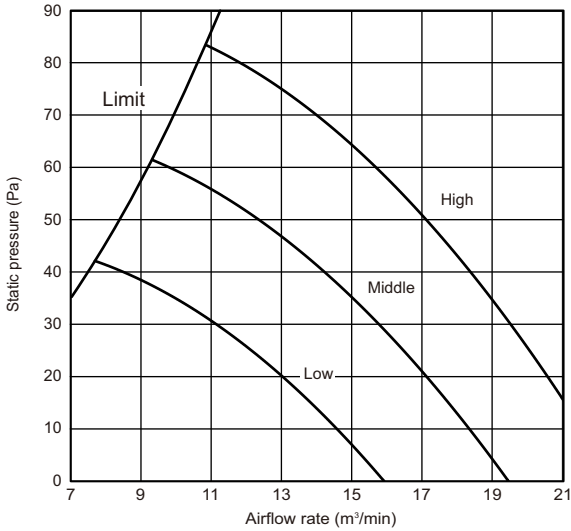

PEFY-WP25VMA-E

External static pressure : 100Pa
Power source : 220-240V

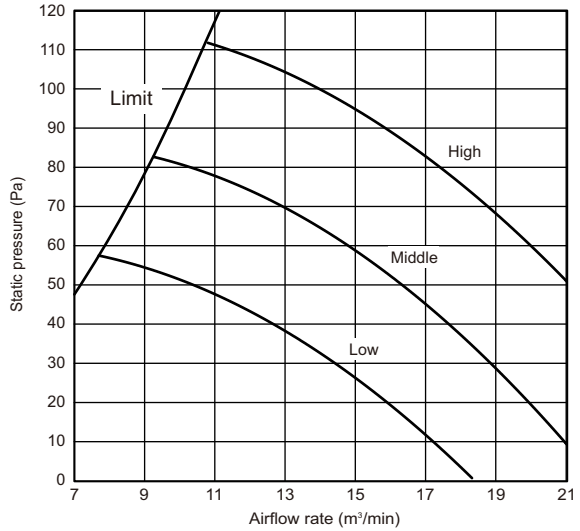

PEFY-WP25VMA-E

External static pressure : 150Pa
Power source : 220-240V

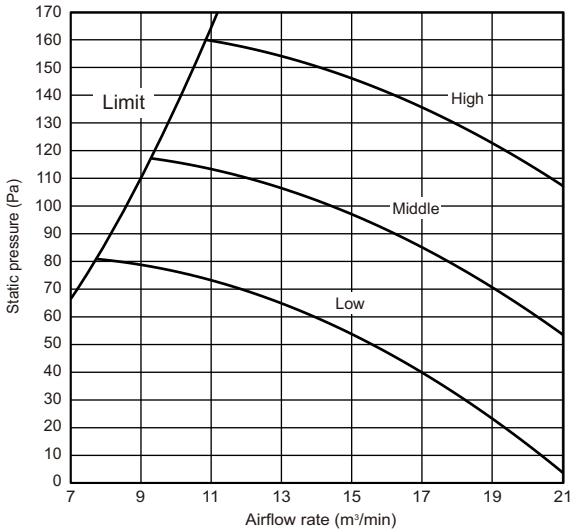

6. FAN CHARACTERISTICS CURVES

PEFY-WP32VMA-E

External static pressure : 35Pa
Power source : 220-240V

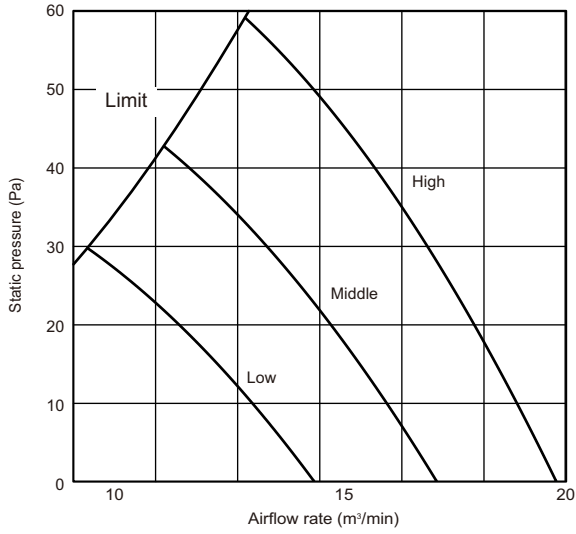

PEFY-WP32VMA-E

External static pressure : 50Pa
Power source : 220-240V

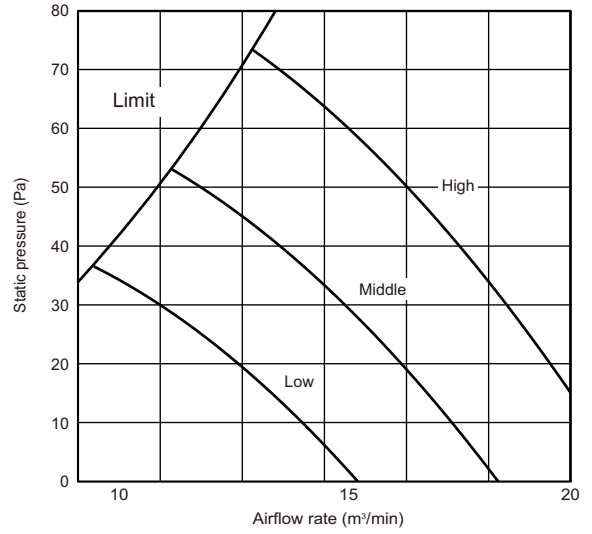

PEFY-WP32VMA-E

External static pressure : 70Pa
Power source : 220-240V

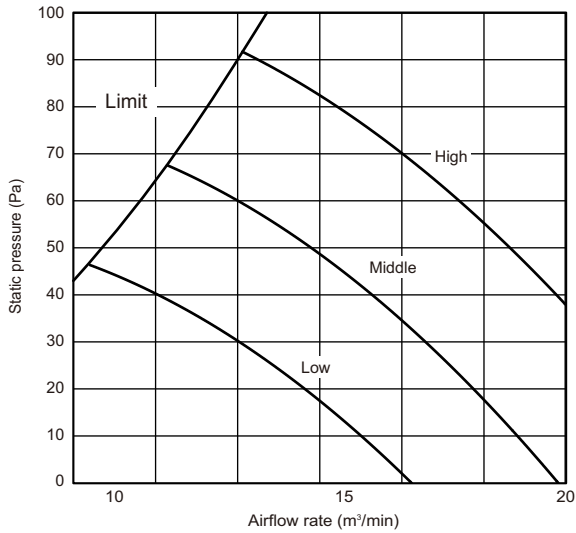

PEFY-WP32VMA-E

External static pressure : 100Pa
Power source : 220-240V

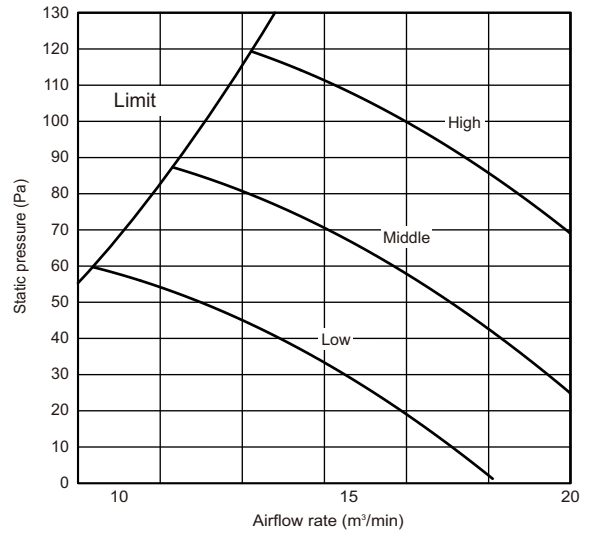

PEFY-WP32VMA-E

External static pressure : 150Pa
Power source : 220-240V

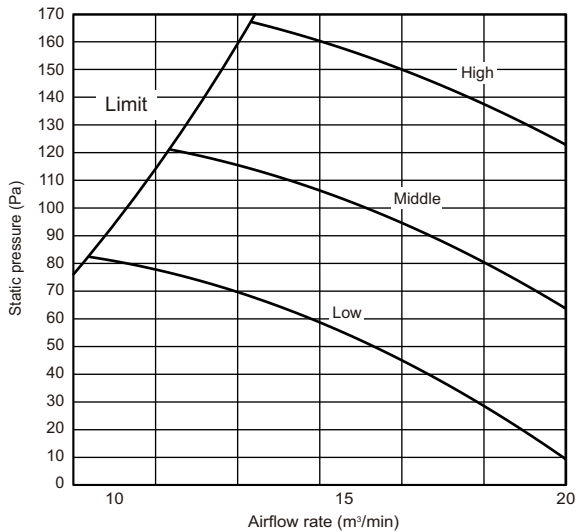

6. FAN CHARACTERISTICS CURVES

PEFY-VMA

PEFY-WP40,50VMA-E

External static pressure : 35Pa
Power source : 220-240V

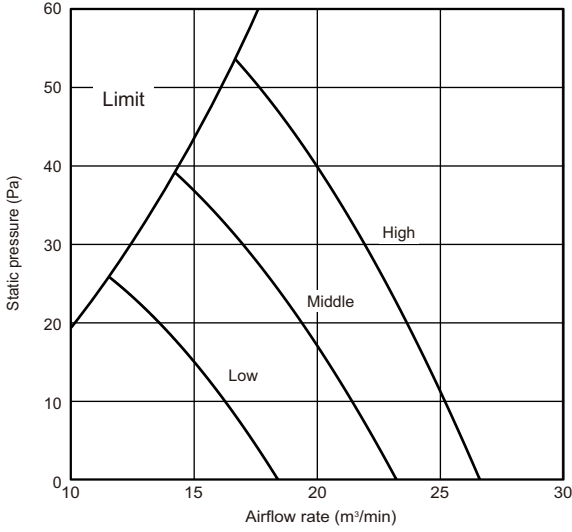

PEFY-WP40,50VMA-E

External static pressure : 50Pa
Power source : 220-240V

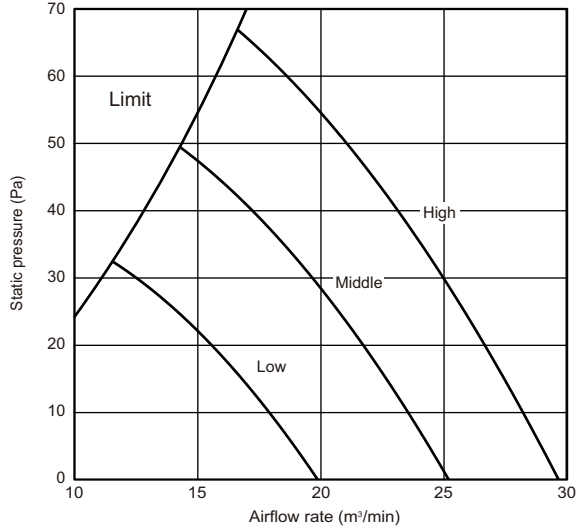

PEFY-WP40,50VMA-E

External static pressure : 70Pa
Power source : 220-240V

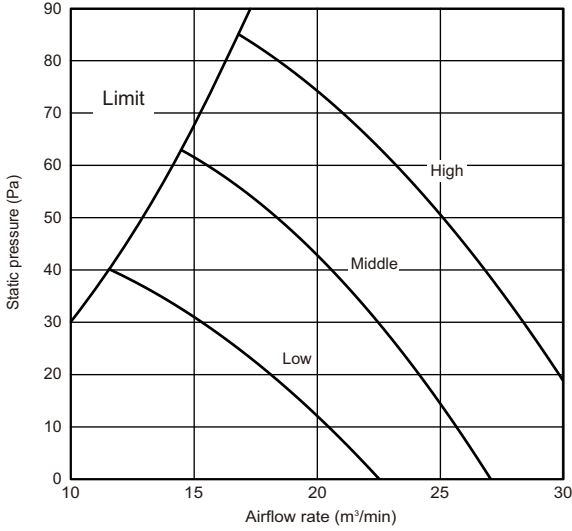

PEFY-WP40,50VMA-E

External static pressure : 100Pa
Power source : 220-240V

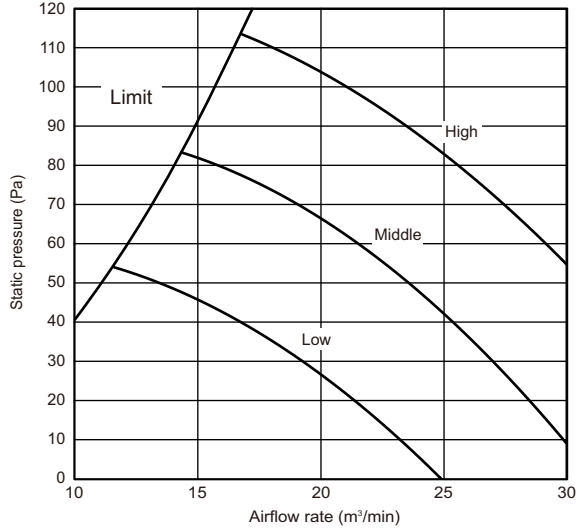

PEFY-WP40,50VMA-E

External static pressure : 150Pa
Power source : 220-240V

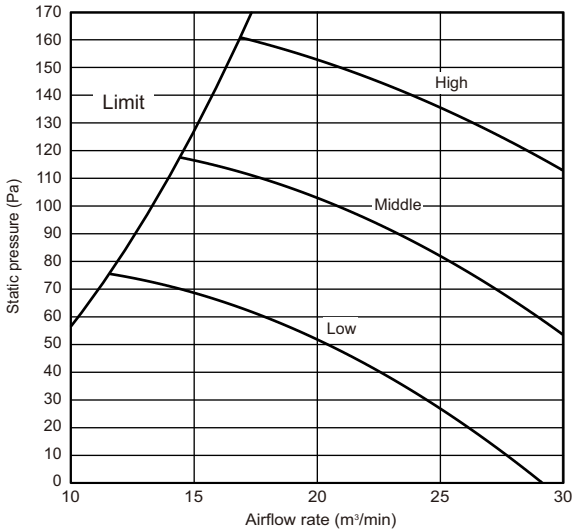

7. OPTIONAL PARTS

7-1. Optional parts line up for the Indoor unit

	Filter box
PEFY-WP20VMA-E	PAC-KE91TB-E
PEFY-WP25, 32VMA-E	PAC-KE92TB-E
PEFY-WP40, 50VMA-E	PAC-KE93TB-E

PEFY-VMA

● PEFY-WP-VMA-E

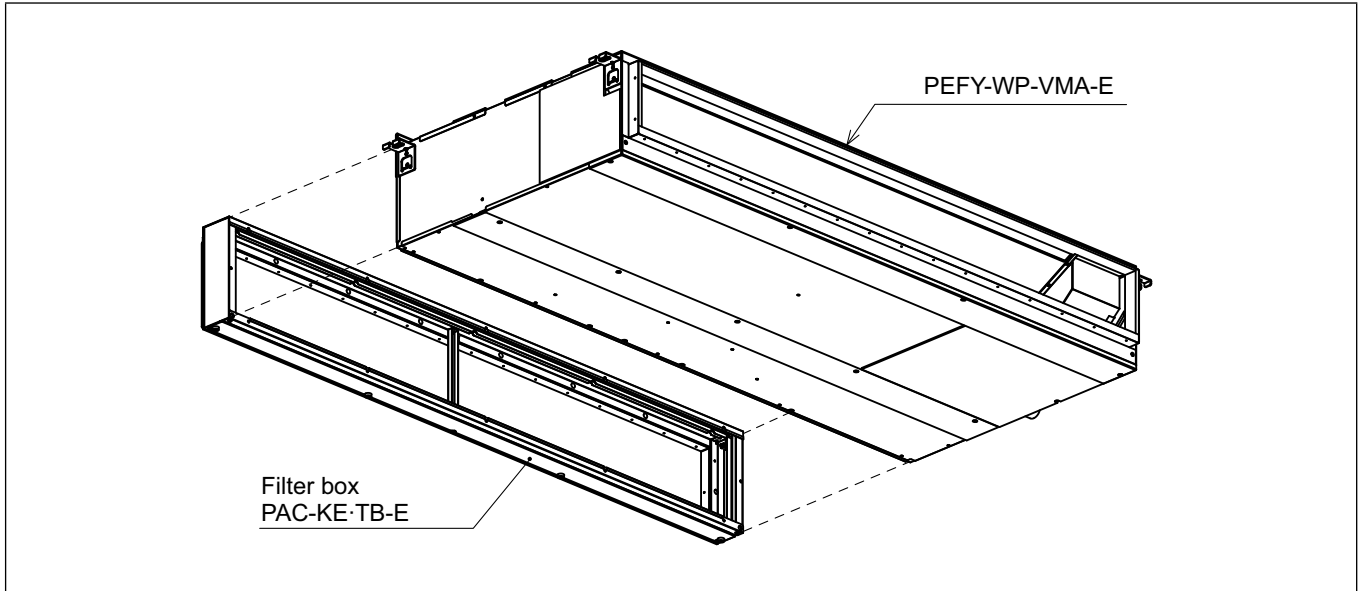

7-2. Filter box

PAC-KE-TB-E

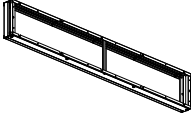
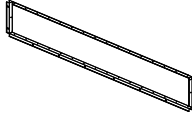
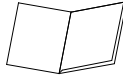
Item	1 Screw	2 Filter box	3 FLANGE	4 Installation manual	
Quantity	30	1	1	1	
Shape					

Detailed installation information should be referred to its Installation Manual.

Ceiling cassette (4-way flow type)

PLFY-WP-VBM-E

1. SPECIFICATIONS	1 - 38
2. EXTERNAL DIMENSIONS	1 - 39
3. CENTER OF GRAVITY	1 - 40
4. ELECTRICAL WIRING DIAGRAMS	1 - 41
5. SOUND LEVELS	1 - 42
5-1. Sound levels	1 - 42
5-2. NC curves	1 - 42
6. TEMPERATURE/AIRFLOW DISTRIBUTIONS	1 - 43
6-1. Temperature distributions	1 - 43
6-2. Airflow distributions	1 - 44
7. OPTIONAL PARTS.....	1 - 45
7-1. Optional parts line up for the Indoor unit.....	1 - 45
7-2. Air outlet shutter plate	1 - 45
7-3. High efficiency filter element.....	1 - 46
7-4. Multi-function casement.....	1 - 46
7-5. i-see sensor corner panel	1 - 47
7-6. Automatic filter elevation panel.....	1 - 47
7-7. Wireless signal receiver.....	1 - 48
7-8. Space panel.....	1 - 48
7-9. Duct flange for fresh air intake	1 - 48

1. SPECIFICATIONS

PLFY-VBM

Model	PLFY-WP32VBM-E		PLFY-WP40VBM-E	PLFY-WP50VBM-E		
Power source	1-phase 220-230-240 V 50/60Hz					
Cooling capacity	*1	kW	3.6	4.5	5.6	
	*1	kcal/h	3,100	3,900	4,800	
	*1	BTU/h	12,300	15,400	19,100	
		Power input	kW	0.04	0.04	0.05
		Current input	A	0.35	0.45	0.45
Heating capacity	*2	kW	4.0	5.0	6.3	
	*2	kcal/h	3,400	4,300	5,400	
	*2	BTU/h	13,600	17,100	21,500	
		Power input	kW	0.03	0.03	0.04
		Current input	A	0.28	0.28	0.38
External finish	Galvanized steel sheet					
External dimension	H x W x D	mm	258 x 840 x 840			
		in.	10-3/16 x 33-3/32 x 33-3/32			
Net weight		kg(lbs)	22(49)			
Heat exchanger	Cross fin (Aluminum fin and copper tube)					
Water Volume		L	1.5			
FAN Type x Quantity	Turbo Fan x 1					
External static press		Pa	0			
Motor Type	DC motor					
Motor output		kW	0.05			
Driving mechanism	Direct-driven by motor					
Air flow rate (Low-Mid1-Mid2-High)		m ³ / min	13-14-15-16	13-14-15-16	13-15-17-19	
		L/ s	217-233-250-267	217-233-250-267	217-250-283-317	
		cfm	459-494-530-565	459-494-530-565	459-530-601-671	
Sound pressure level (Low-Mid1-Mid2-High)		dB<A>	27-29-30-31	27-29-30-31	27-30-32-34	
Insulation material	PS					
Air filter	PP honeycomb					
Protection device	Fuse					
Refrigerant control device	-					
Connectable outdoor unit/HBC controller	CITY MULTI YLM series/CMB-WP-V-GA1, CMB-WP-V-GB1					
Water piping diameter	*3*4	Inlet	in.	Rc 3/4 screw		
		Outlet	in.	Rc 3/4 screw		
Field drain pipe size		mm (in.)	O.D.32 (1-1/4)			
Standard attachment	Document accessory	Installation Manual, Instruction Book				
Optional parts	Decoration panel **1	PLP-6BA				
	Automatic filter elevation panel **1	PLP-6BAJ				
	Space panel	PAC-SH48AS-E				
	Air outlet shutter plate	PAC-SH51SP-E				
	High efficiency filter element **2	PAC-SH59KF-E				
	Multi-function casement	PAC-SH53TM-E				
	i-see sensor corner panel	PAC-SA1ME-E				
	Flange for fresh air intake	PAC-SH65OF-E				
	Wireless signal receiver	PAR-SF9FA-E				
		**1.PLFY-P-VBM-E should use together with PLP-6BA(J). **2.PAC-SH53TM-E is necessary to use with filter PAC-SH59KF-E.				
Remarks	*Details on foundation work, duct work, insulation work, electrical wiring, power source switch, and other items shall be referred to the Installation Manual. *Due to continuing improvement, above specifications may be subject to change without notice.					

Notes:	Unit converter
1.Nominal cooling conditions Indoor: 27°C.D.B./19°C.W.B. (81°F.D.B./66°F.W.B.), Outdoor: 35°C.D.B. (95°F.D.B.) Pipe length: 7.5 m (24-9/16 ft.), Level difference: 0 m (0 ft.)	kcal/h =kW x 860 BTU/h =kW x 3,412 cfm =m ³ /min x 35.31 lbs =kg/0.4536
2.Nominal heating conditions Indoor: 20°C.D.B. (68°F.D.B.), Outdoor: 7°C.D.B./6°C.W.B. (45°F.D.B./43°F.W.B.) Pipe length: 7.5 m (24-9/16 ft.), Level difference: 0 m (0 ft.)	
3.Be sure to install a valve on the water outlet.	
4.Install a strainer (40 mesh or more) on the pipe next to the valve to remove the foreign matters.	
5.Please group units that operate on 1 branch.	

2. EXTERNAL DIMENSIONS

PLFY-WP32, 40, 50VBM-E

Unit : mm

- Note 1. Please choose the Grille from a standard grille, Auto-Grille.
 2. As for drain pipe, please use VP-25(O.D. ϕ 32 PVC TUBE).
 Drain pump inclusion.
 Raise is max. 850mm from the ceiling.
 3. As for suspension bolt, please use M10 or W3/8.
 (Procured at local site)
 4. Electrical box may be removed for the service purpose.
 Make sure to slack the electrical wire little bit for control/power wires connection.
 5. The height of the indoor unit is able to be adjusted with the grille attached.
 6. For the installation of the optional high efficiency filter or optional multi-functional casement.
 (Reference of the 2nd sheet of detailed Figure)
 1) Requires 400 mm or more space between transom and ceiling for the installation.
 2) Add 135 mm to the dimensions \otimes marked on the figure.
 3) The optional high efficiency filter becomes optional multi-functional casement and concomitant use.
 7. When installing the branch ducts, be sure to insulate adequately. Otherwise condensation and dripping may occur.
 (It becomes the cause of dew drops/Wear dew.)
 8. As for necessary installation/service space, please refer to the under at figure.

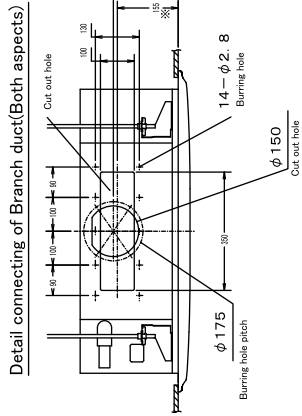
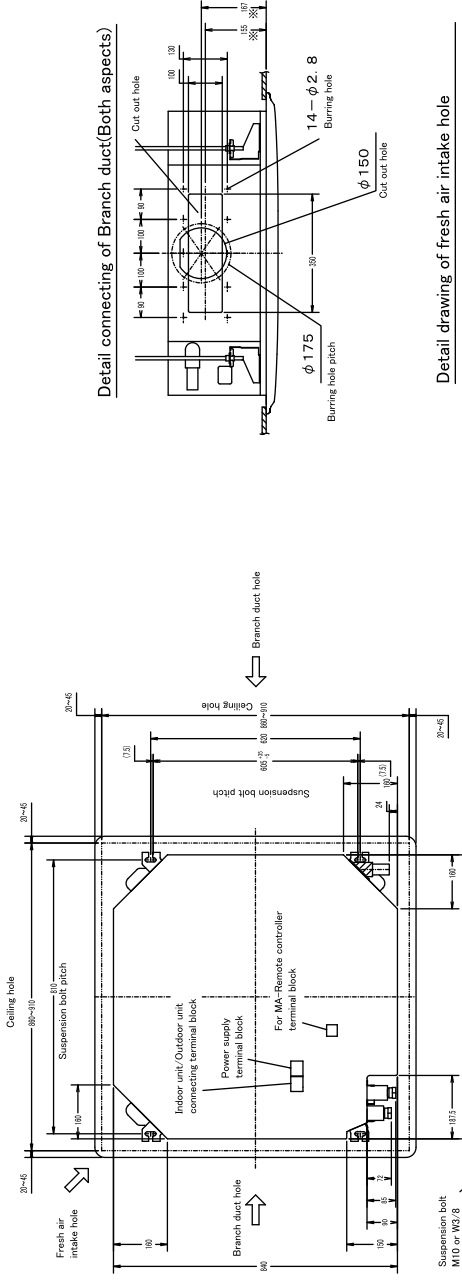

Detail drawing of fresh air intake hole

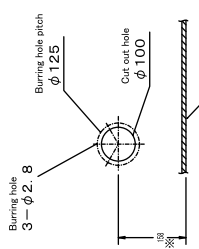

(Connected the attached flexible pipe or socket.)
 Keep approximately 10 to 15mm space between unit ceiling and ceiling slab.

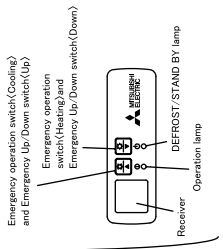
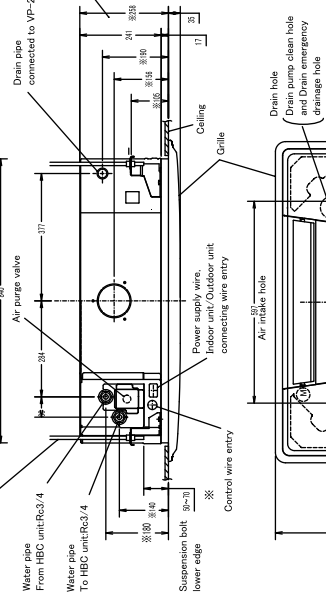

In case of standard grille: P-LP-6BA / P-LP-6BAMD
 In case of Auto-Grille: P-LP-6BAU
 In case of wireless remote controller: P-LP-6BALM

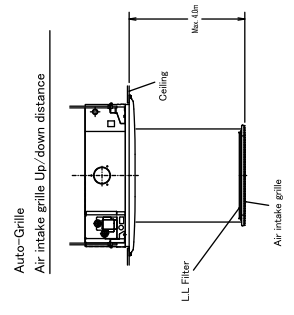
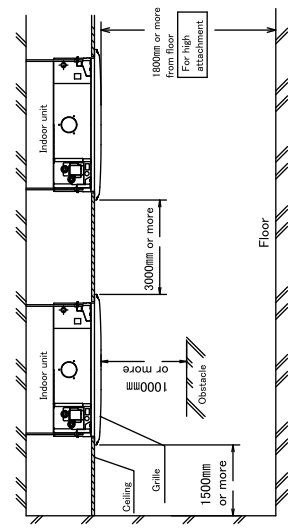

3. CENTER OF GRAVITY

PLFY-WP32, 40, 50VBM-E

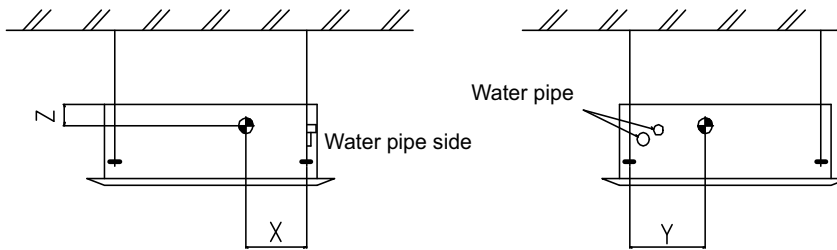

(mm) [in]

Model name	X	Y	Z
PLFY-WP32VBM-E	280 [11-1/32]	400 [15-3/4]	105 [4-5/32]
PLFY-WP40VBM-E	280 [11-1/32]	400 [15-3/4]	105 [4-5/32]
PLFY-WP50VBM-E	280 [11-1/32]	400 [15-3/4]	105 [4-5/32]

4. ELECTRICAL WIRING DIAGRAMS

PLFY-WP32, 40, 50VBM-E

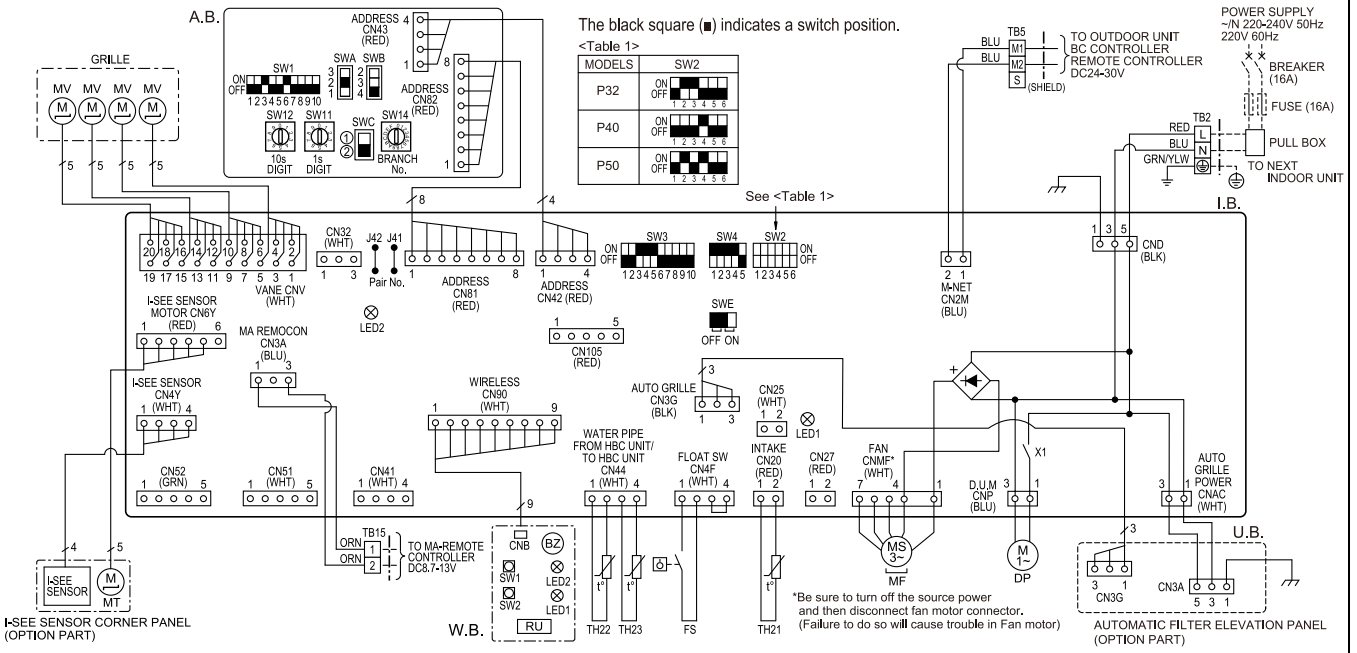

NOTES:

- At servicing for outdoor unit, always follow the wiring diagram of outdoor unit.
- In case of using MA-Remote controller, please connect to TB15. (Remote controller wire is non-polar.)
- In case of using M-NET, please connect to TB5. (Transmission line is non-polar.)
- Symbol [S] of TB5 is the shield wire connection.
- Symbols used in wiring diagram above are, □□□ : terminal block, ○○○ : connector.
- The setting of the SW2 dip switches differs in the capacity. For the detail, refer to <Table 1>.

[LEGEND]

SYMBOL	NAME	SYMBOL	NAME	SYMBOL	NAME
I.B.	INDOOR CONTROLLER BOARD	DP	DRAIN PUMP	A.B.	ADDRESS BOARD
CN27	CONNECTOR DAMPER	FS	DRAIN FLOAT SWITCH	SWA	SWITCH CEILING HEIGHT SELECTOR
CN32	CONNECTOR REMOTE SWITCH	MF	FAN MOTOR	SWB	SWITCH DISCHARGE OUTLET NUMBER SELECTOR
CN51	CONNECTOR CENTRALLY CONTROL	MV	VANE MOTOR	SWC	SWITCH OPTION SELECTOR
CN52	CONNECTOR REMOTE INDICATION	TB2	TERMINAL BLOCK	SW11	SWITCH MODE SELECTION
CN105	IT TERMINAL	TB5	TERMINAL BLOCK	SW12	SWITCH ADDRESS SETTING ONES DIGIT
FUSE	FUSE (T6.3A/250V)	TB15	TERMINAL BLOCK	SW14	SWITCH ADDRESS SETTING TENS DIGIT CONNECTION NO.
LED1	POWER SUPPLY (I.B.)	TH21	THERMISTOR	OPTION PART	
LED2	POWER SUPPLY (I.B.)			W.B.	PCB FOR WIRELESS REMOTE CONTROLLER
SW2	SWITCH CAPACITY CODE	TH22	THERMISTOR	BZ	BUZZER
SW3	SWITCH MODE SELECTION			LED1	LED (OPERATION INDICATION : GREEN)
SW4	SWITCH MODEL SELECTION	TH23	THERMISTOR	LED2	LED (PREPARATION FOR HEATING : ORANGE)
SWE	SWITCH DRAIN PUMP (TEST MODE)			RU	RECEIVING UNIT
X1	AUX. RELAY DRAIN PUMP			SW1	SWITCH EMERGENCY OPERATION (HEAT/DOWN)
				SW2	SWITCH EMERGENCY OPERATION (COOL/UP)

LED on indoor board for service

Mark	Meaning	Function
LED1	Main power supply	Main Power supply (Indoor unit:220-240V) power on → lamp is lit
LED2	Power supply for MA-Remote controller	Power supply for MA-Remote controller on → lamp is lit

PLFY-VBM

5. SOUND LEVELS

5-1. Sound levels

PLFY-WP-VBM-E

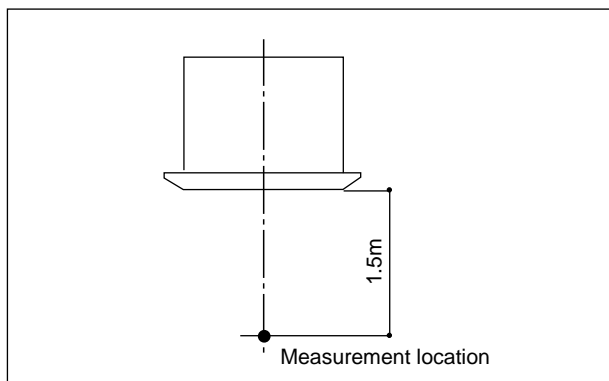

Sound level at anechoic room: Low-Mid2-Mid1-High

	Sound level dB (A)
PLFY-WP32VBM-E	27-29-30-31
PLFY-WP40VBM-E	27-29-30-31
PLFY-WP50VBM-E	27-30-32-34

* Measured in anechoic room.

PLFY-VBM

5-2. NC curves

PLFY-WP32, 40VBM-E

External Static Pressure: 0Pa
Power Source: 220, 230, 240V, 50/60Hz

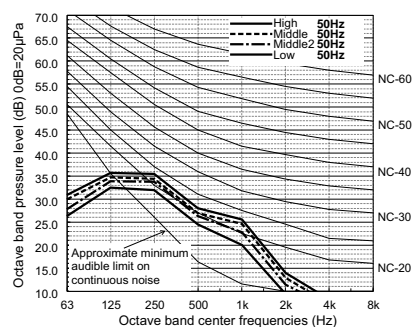

PLFY-WP50VBM-E

External Static Pressure: 0Pa
Power Source: 220, 230, 240V, 50/60Hz

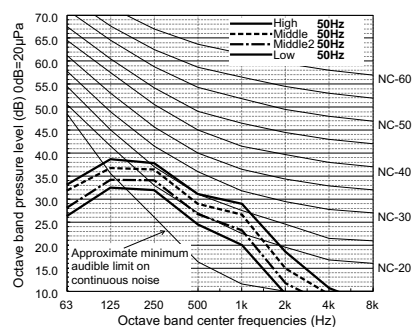

6. TEMPERATURE/AIRFLOW DISTRIBUTIONS

6-1. Temperature distributions

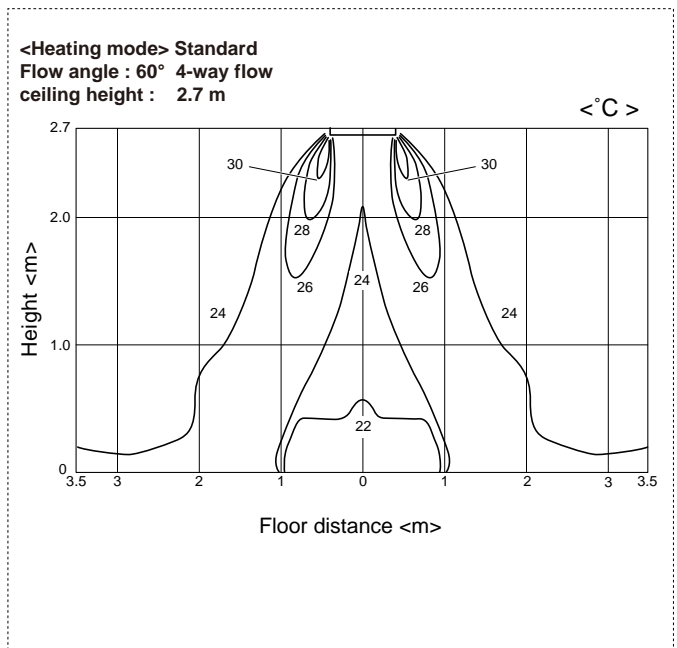
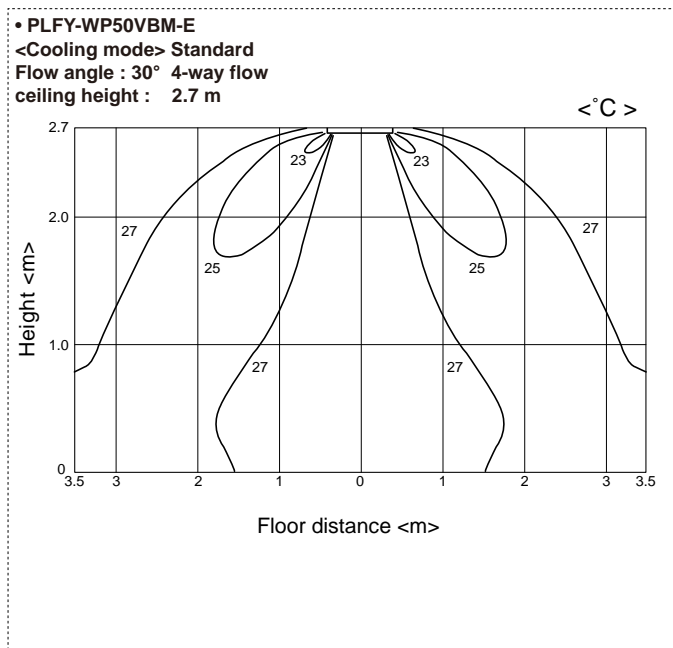
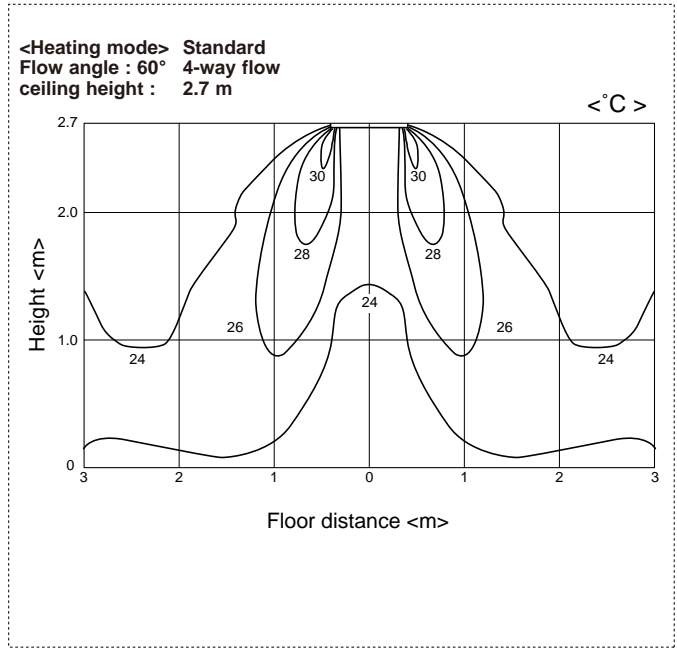
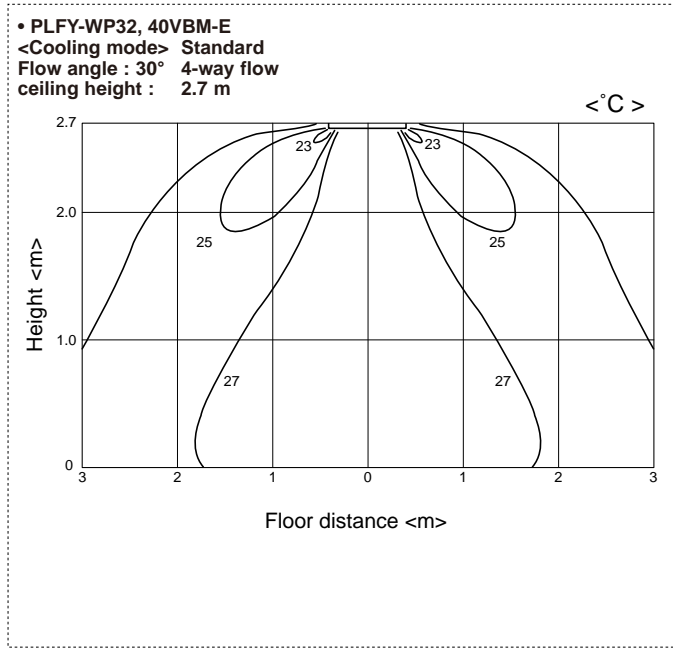

Note : These figures show typical temperature distributions in the conditions above. In the actual installation, they may differ from these figures under the influence of air temperature conditions, ceiling height, cooling/heating load, obstacles, etc.

6. TEMPERATURE/AIRFLOW DISTRIBUTIONS

6-2. Airflow distributions

PLFY-VBM

PLFY-WP32, 40VBM-E

<Cooling mode>
Flow angle 30°

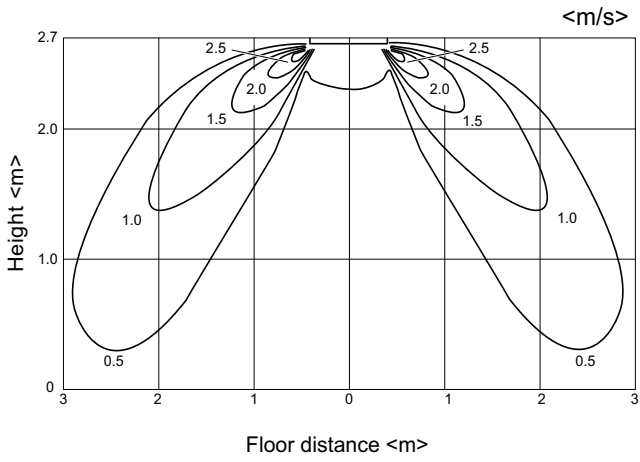

<Heating mode>
Flow angle 60°

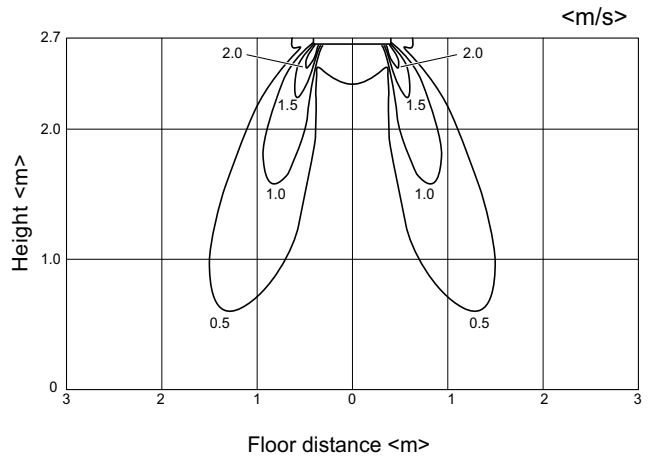

PLFY-WP50VBM-E

<Cooling mode>
Flow angle 30°

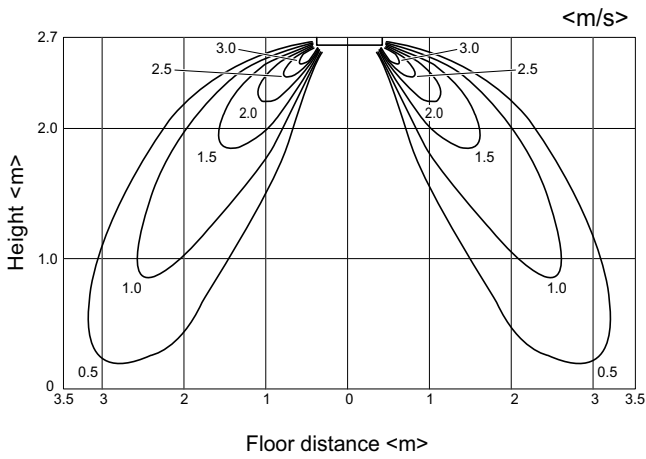

<Heating mode>
Flow angle 60°

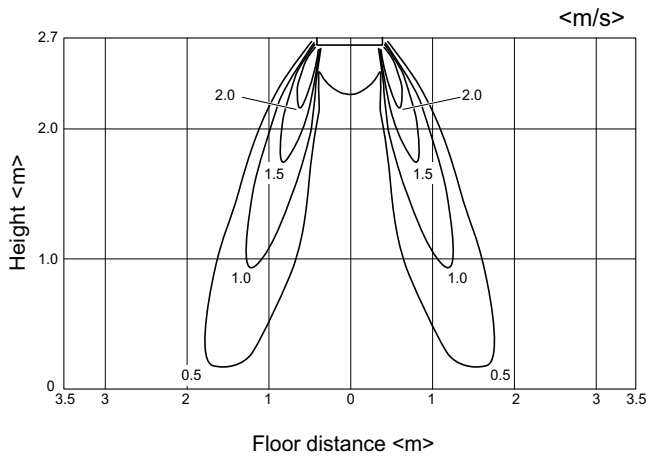

Note : These figures show typical airflow distributions in the conditions above. In the actual installation, they may differ from these figures under the influence of air temperature conditions, ceiling height, cooling/heating load, obstacles, etc.

7. OPTIONAL PARTS

7-1. Optional parts line up for the Indoor unit

	Description	Model
PLFY-WP-VBM-E	Air outlet shutter plate	PAC-SH51SP-E
	Multi-function casement	PAC-SH53TM-E
	High efficiency filter element	PAC-SH59KF-E
	i-see Sensor corner panel	PAC-SA1ME-E
	Automatic filter elevation panel	PLP-6BAJ
	Wireless signal receiver	PAR-SA9FA-E
	Space panel	PAC-SH48AS-E
	Duct flange for fresh air intake	PAC-SH65OF-E

PLFY-WP-VBM-E

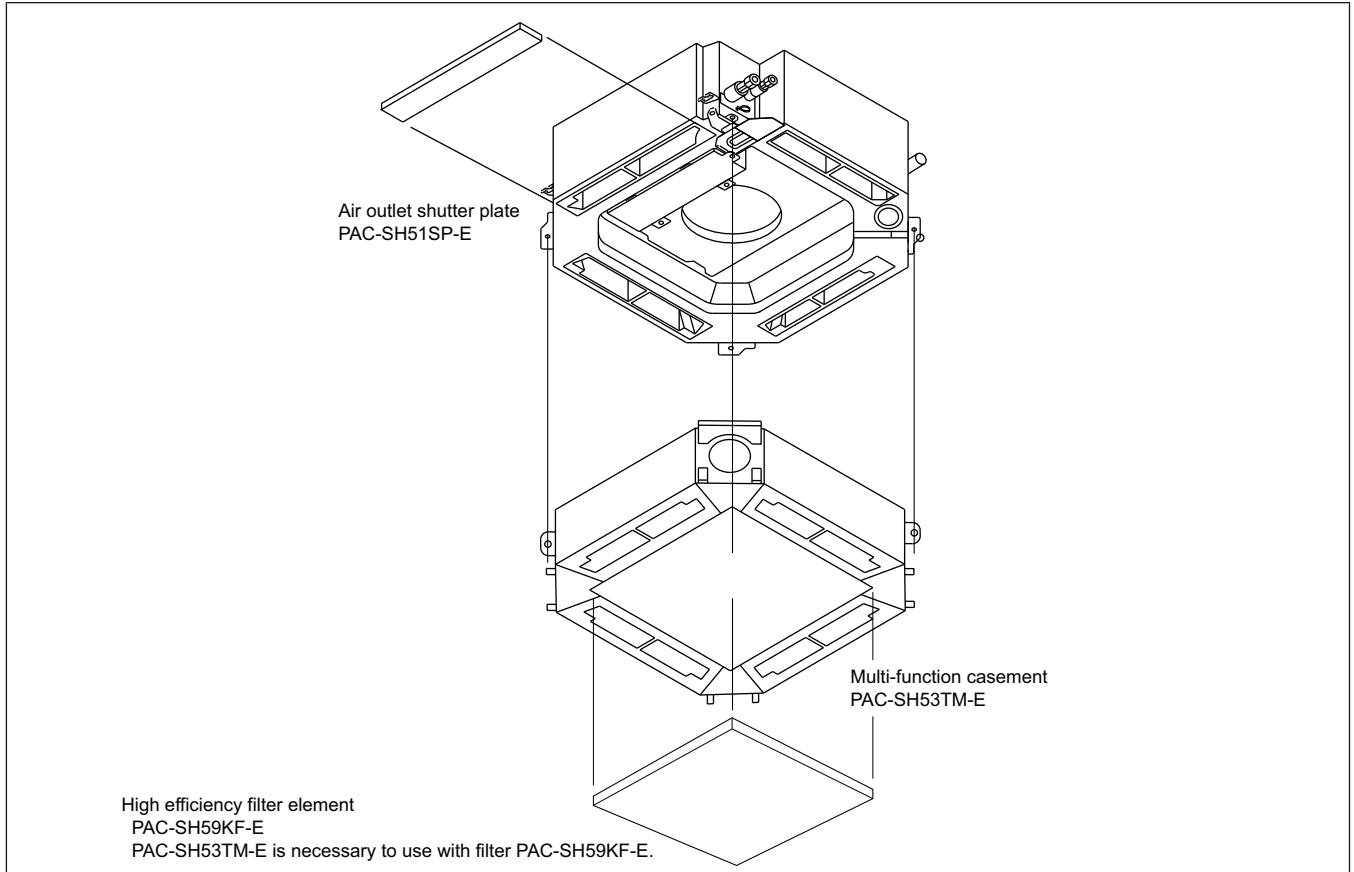

PLFY-VBM

7-2. Air outlet shutter plate

Using the air outlet shutter plate to block the air outlet to modify the air-way from 4 to 3 or 2.

With 1 PAC-SH51SP-E, 4 air-ways can be changed to 3;

With 2 PAC-SH51SP-E, 4 air-ways can be changed to 2;

Changing to 1 way is not allowed.

Material: Foamed polyethylene + foamed urethane, color: Black

Item	① Shutter plate	② Insulator	
Quantity	2	1	
Shape			

Detailed installation information should be referred to its Installation Manual.

7. OPTIONAL PARTS

7-3. High efficiency filter element

Life span: 2,500 hr (Dust concentration 0.15mg/m³); Colorimetric method 65% (JIS 11 class); No re-production.

* The actual dust situation affects the filter life span, which should be considered at the applying site.

Material: Electrostatic polyolefin fiber

High efficiency filter element PAC-SH59KF-E should be used together with the Multi-function casement PAC-SH53TM-E. When using PAC-SH59KF-E, switching on SWC of the Indoor unit address board is needed. Details should be referred to its Installation Manual.

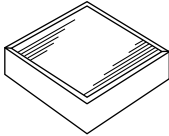
Quantity	1	
Shape		

Detailed installation information is referred in its Installation Manual.



7-4. Multi-function casement

Multi-function casement is used for High efficiency filter element and/or fresh air intake from outdoor.

It should be used with High efficiency filter element PAC-SH59KF-E (Colorimetric method 65%).

Fresh air intake on the Multi-function casement is possible from any 2 or less corners among the 4 ones.

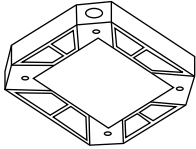
But duct and flange on the casement should be prepare locally.

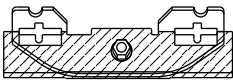
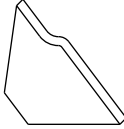
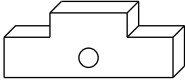

Item	① Multi-functional casement	② Screw with washer (black)	③ Screw
Quantity	1	4	8
Shape		M5X0.8X25 	M5X0.8X12 
Item	④ Decorative panel securing bracket	⑤ Insulator A for Decorative panel	⑥ Insulator B for Decorative panel
Quantity	4	1	1
Shape	With insulator 		

Detailed installation information should be referred to its Installation Manual.

7. OPTIONAL PARTS

7-5. i-see sensor corner panel





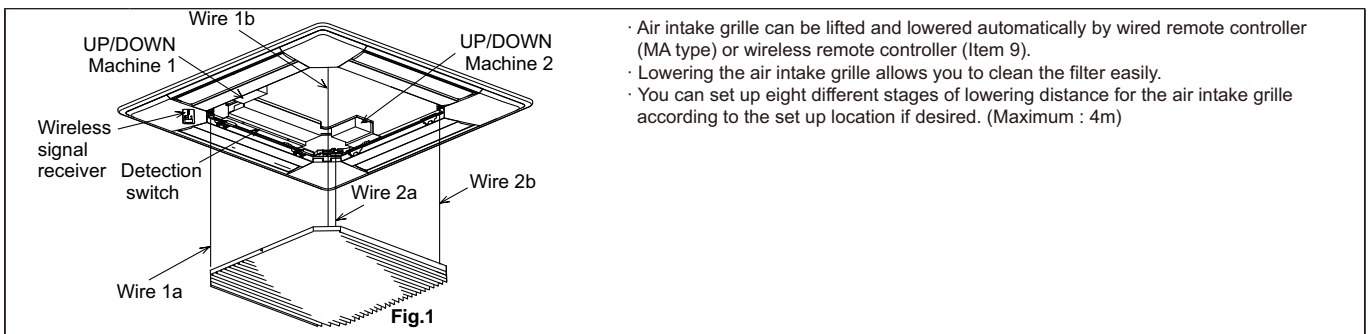

i-see sensor provides comfortable space as it detects the floor temperature to prevent spotty temperature. And that enables the unit to save energy.
 Attention
 Make sure that there are no gaps between the unit and the grille, and the grille and ceiling.
 ※ It may cause dew dripping.

Item	① i-see sensor corner panel	② Plastic fastener	
Quantity	1	2	
Shape			

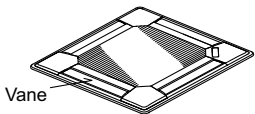
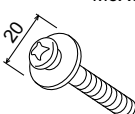
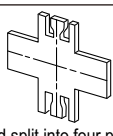
Detailed installation information should be referred to its Installation Manual.

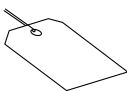
7-6. Automatic filter elevation panel



Item	① Decorative panel	② Screw with washer	③ Installation gauge	④ Plastic fastener
Quantity	1	4	1	3
Shape	 Vane	 M5X0.8X25	 (Used split into four pieces)	
Item	⑤ Tag	⑥ Screw	⑦ Screw	⑧ Screw
Quantity	1	4	1	3
Shape		 4X8 Only three are used	 4X12	 M5X10
Item	⑨ Wireless remote controller			
Quantity	1			
Shape				

Detailed installation information should be referred to its Installation Manual.

7. OPTIONAL PARTS

7-7. Wireless signal receiver



Wireless signal receiver PAR-SA9FA-E is necessary for using wireless remote controller PAR-SA9FA-E is a corner panel with the signal receiver for wireless remote controller.		
Item	① Wireless signal receiver	
Quantity	1	
Shape		

Detailed installation information should be referred to its Installation Manual.

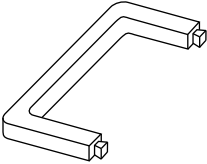
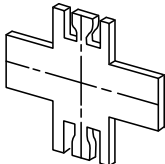
7-8. Space panel

Decorative cover for the installation when the ceiling height is low.		
Item	① Space panel	② Gauge for installation
Quantity	2	1
Shape		

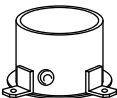
7-9. Duct flange for fresh air intake

Part to attach a duct to take in fresh air from outdoors.			
Item	① Duct flange	② Insulator	③ Screws (M4 x 10)
Quantity	1	1	3
Shape			

Floor standing (Concealed type)

PFFY-WP-VLRMM-E

1. SPECIFICATIONS	1 - 50
2. EXTERNAL DIMENSIONS	1 - 52
3. CENTER OF GRAVITY	1 - 53
4. ELECTRICAL WIRING DIAGRAMS	1 - 54
5. SOUND LEVELS	1 - 55
5-1. Sound levels	1 - 55
5-2. NC curves	1 - 55
6. FAN CHARACTERISTICS CURVES.....	1 - 57

1. SPECIFICATIONS

Model			PFFY-WP20VLRMM-E	PFFY-WP25VLRMM-E	PFFY-WP32VLRMM-E	PFFY-WP40VLRMM-E	
Power source			1-phase 220-230-240 V 50/60 Hz	1-phase 220-230-240 V 50/60 Hz	1-phase 220-230-240 V 50/60 Hz	1-phase 220-230-240 V 50/60 Hz	
Cooling capacity (Nominal)	*1	kW	2.2	2.8	3.6	4.5	
	*1	kcal/h	1,900	2,400	3,100	3,900	
	*1	BTU/h	7,500	9,600	12,300	15,400	
	*2	Power input	kW	0.040	0.040	0.050	0.050
	*2	Current input	A	0.35	0.35	0.47	0.47
Heating capacity (Nominal)	*3	kW	2.5	3.2	4.0	5.0	
	*3	kcal/h	2,200	2,800	3,400	4,300	
	*3	BTU/h	8,500	10,900	13,600	17,100	
	*2	Power input	kW	0.040	0.040	0.050	0.050
	*2	Current input	A	0.35	0.35	0.47	0.47
External finish			Galvanized steel plate	Galvanized steel plate	Galvanized steel plate	Galvanized steel plate	
External dimension H x W x D			mm	639 x 886 x 220	639 x 1,006 x 220	639 x 1,006 x 220	639 x 1,246 x 220
			in.	25-3/16 x 34-15/16 x 8-11/16	25-3/16 x 39-5/8 x 8-11/16	25-3/16 x 39-5/8 x 8-11/16	25-3/16 x 49-1/16 x 8-11/16
Net weight			kg (lbs)	22 (49)	25 (56)	25 (56)	29 (64)
Heat exchanger			Cross fin (Aluminum fin and copper tube)	Cross fin (Aluminum fin and copper tube)	Cross fin (Aluminum fin and copper tube)	Cross fin (Aluminum fin and copper tube)	
Water Volume		L	0.9	1.3	1.3	1.5	
FAN	Type x Quantity		Sirocco fan x 1	Sirocco fan x 2	Sirocco fan x 2	Sirocco fan x 2	
	*4	External static press.	Pa	20 - <40> - <60>	20 - <40> - <60>	20 - <40> - <60>	20 - <40> - <60>
			mmH ₂ O	2.0 - <4.1> - <6.1>	2.0 - <4.1> - <6.1>	2.0 - <4.1> - <6.1>	2.0 - <4.1> - <6.1>
	Motor Type		DC motor	DC motor	DC motor	DC motor	
	Motor output		kW	0.096	0.096	0.096	0.096
	Driving mechanism		Direct-driven by motor	Direct-driven by motor	Direct-driven by motor	Direct-driven by motor	
	Air flow rate		(Low-Mid-High)	(Low-Mid-High)	(Low-Mid-High)	(Low-Mid-High)	
			m ³ /min	4.5 - 5.0 - 6.0	6.0 - 7.0 - 8.0	7.5 - 9.0 - 10.5	8.0 - 10.0 - 11.5
L/s			75 - 83 - 100	100 - 117 - 133	125 - 150 - 175	133 - 167 - 192	
cfm		159 - 177 - 212	212 - 247 - 282	265 - 318 - 371	282 - 353 - 406		
Sound pressure level (measured in anechoic room)			(Low-Mid-High)	(Low-Mid-High)	(Low-Mid-High)	(Low-Mid-High)	
*2		dB <A>	31-33-38	31-33-38	31-35-38	34-37-40	
Insulation material			Polyethylene foam, Urethane foam	Polyethylene foam, Urethane foam	Polyethylene foam, Urethane foam	Polyethylene foam, Urethane foam	
Air filter			PP honeycomb fabric.	PP honeycomb fabric.	PP honeycomb fabric.	PP honeycomb fabric.	
Protection device			Fuse	Fuse	Fuse	Fuse	
Refrigerant control device			-	-	-	-	
Connectable outdoor unit			CITY MULTI YLM series/ CMB-WP-V-GA1, CMB-WP-V-GB1	CITY MULTI YLM series/ CMB-WP-V-GA1, CMB-WP-V-GB1	CITY MULTI YLM series/ CMB-WP-V-GA1, CMB-WP-V-GB1	CITY MULTI YLM series/ CMB-WP-V-GA1, CMB-WP-V-GB1	
Water piping diameter	*5	Inlet	in.	Rc 3/4 screw	Rc 3/4 screw	Rc 3/4 screw	Rc 3/4 screw
	*6	Outlet	in.	Rc 3/4 screw	Rc 3/4 screw	Rc 3/4 screw	Rc 3/4 screw
Field drain pipe size			mm (in.)	I.D.26 (1) <Accessory hose O.D.27 (1-3/32) (top end: O.D.20 (13/16))>	I.D.26 (1) <Accessory hose O.D.27 (1-3/32) (top end: O.D.20 (13/16))>	I.D.26 (1) <Accessory hose O.D.27 (1-3/32) (top end: O.D.20 (13/16))>	I.D.26 (1) <Accessory hose O.D.27 (1-3/32) (top end: O.D.20 (13/16))>
Drawing	External		KD94T792X01	KD94T792X01	KD94T792X01	KD94T792X01	
	Wiring		KD94T791X01	KD94T791X01	KD94T791X01	KD94T791X01	
	Refrigerant cycle		-	-	-	-	
Standard attachment	Document		Installation Manual, Instruction Book	Installation Manual, Instruction Book	Installation Manual, Instruction Book	Installation Manual, Instruction Book	
	Accessory		Insulation pipe for water pipe, Drain hose (flexible joint), Screw plate, Level adjusting screw, Hose band	Insulation pipe for water pipe, Drain hose (flexible joint), Screw plate, Level adjusting screw, Hose band	Insulation pipe for water pipe, Drain hose (flexible joint), Screw plate, Level adjusting screw, Hose band	Insulation pipe for water pipe, Drain hose (flexible joint), Screw plate, Level adjusting screw, Hose band	
Optional parts							
Remarks			Details on foundation work, duct work, insulation work, electrical wiring, power source switch, and other items shall be referred to the Installation Manual. Due to continuing improvement, above specifications may be subject to change without notice.				

Notes:	Unit converter
1.Nominal cooling conditions Indoor: 27 °CD.B./19 °CW.B. (81 °FD.B./66 °FW.B.), Outdoor: 35 °CD.B. (95 °FD.B.) Pipe length: 7.5 m (24-9/16 ft.), Level difference: 0 m (0 ft.)	kcal/h =kW x 860
2.The values are measured at the factory setting of external static pressure.	BTU/h =kW x 3,412
3.Nominal heating conditions Indoor: 20 °CD.B. (68 °FD.B.), Outdoor: 7 °CD.B./6 °CW.B. (45 °FD.B./43 °FW.B.) Pipe length: 7.5 m (24-9/16 ft.), Level difference: 0 m (0 ft.)	cfm =m ³ /min x 35.31
4.The factory setting of external static pressure is shown without < > . Refer to "Fan characteristics curves", according to the external static pressure, in DATA BOOK for the usable range of air flow rate.	lbs =kg/0.4536
5.Be sure to install a valve on the water outlet.	
6.Install a strainer (40 mesh or more) on the pipe next to the valve to remove the foreign matters.	
7.Please group units that operate on 1 branch.	*Above specification data is subject to rounding variation.

1. SPECIFICATIONS

Model			PFFY-WP50VLRMM-E		
Power source			1-phase 220-230-240 V 50/60 Hz		
Cooling capacity (Nominal)	*1	kW	5.6		
	*1	kcal/h	4,800		
	*1	BTU/h	19,100		
	*2	Power input	kW	0.070	
	*2	Current input	A	0.65	
Heating capacity (Nominal)	*3	kW	6.3		
	*3	kcal/h	5,400		
	*3	BTU/h	21,500		
	*2	Power input	kW	0.070	
	*2	Current input	A	0.65	
External finish			Galvanized steel plate		
External dimension H x W x D			mm	639 x 1,246 x 220	
			in.	25-3/16 x 49-1/16 x 8-11/16	
Net weight			kg (lbs)	29 (64)	
Heat exchanger			Cross fin (Aluminum fin and copper tube)		
Water Volume			L	1.5	
FAN	Type x Quantity		Sirocco fan x 2		
	*4	External static press.	Pa	20 - <40> - <60>	
			mmH ₂ O	2.0 - <4.1> - <6.1>	
	Motor Type		DC motor		
	Motor output		kW	0.096	
	Driving mechanism			Direct-driven by motor	
	Air flow rate			(Low-Mid-High)	
				m ³ /min	10.5 - 13.0 - 15.0
L/s				175 - 217 - 250	
cfm			371 - 459 - 530		
Sound pressure level (measured in anechoic room)			(Low-Mid-High)		
*2			dB <A>	37-42-45	
Insulation material			Polyethylene foam, Urethane foam		
Air filter			PP honeycomb fabric.		
Protection device			Fuse		
Refrigerant control device			-		
Connectable outdoor unit			CITY MULTI YLM series/ CMB-WP-V-GA1, CMB-WP-V-GB1		
Water piping diameter	*5	Inlet	in.	Rc 3/4 screw	
	*6	Outlet	in.	Rc 3/4 screw	
Field drain pipe size			mm (in.)	I.D.26 (1) <Accessory hose O.D.27 (1-3/32) (top end: O.D.20 (13/16))>	
Drawing	External		KD94T792X01		
	Wiring		KD94T791X01		
	Refrigerant cycle		-		
Standard attachment	Document		Installation Manual, Instruction Book		
	Accessory		Insulation pipe for water pipe, Drain hose (flexible joint), Screw plate, Level adjusting screw, Hose band		
Optional parts					
Remarks			Details on foundation work, duct work, insulation work, electrical wiring, power source switch, and other items shall be referred to the Installation Manual. Due to continuing improvement, above specifications may be subject to change without notice.		

Notes:	Unit converter
1.Nominal cooling conditions Indoor: 27 °CD.B./19 °CW.B. (81 °FD.B./66 °FW.B.), Outdoor: 35 °CD.B. (95 °FD.B.) Pipe length: 7.5 m (24-9/16 ft.), Level difference: 0 m (0 ft.)	kcal/h =kW x 860 BTU/h =kW x 3,412
2.The values are measured at the factory setting of external static pressure.	cfm =m ³ /min x 35.31
3.Nominal heating conditions Indoor: 20 °CD.B. (68 °FD.B.), Outdoor: 7 °CD.B./6 °CW.B. (45 °FD.B./43 °FW.B.) Pipe length: 7.5 m (24-9/16 ft.), Level difference: 0 m (0 ft.)	lbs =kg/0.4536
4.The factory setting of external static pressure is shown without < > . Refer to "Fan characteristics curves", according to the external static pressure, in DATA BOOK for the usable range of air flow rate.	
5.Be sure to install a valve on the water outlet.	
6.Install a strainer (40 mesh or more) on the pipe next to the valve to remove the foreign matters.	
7.Please group units that operate on 1 branch.	*Above specification data is subject to rounding variation.

2. EXTERNAL DIMENSIONS

PFFY-WP20, 25, 32, 40, 50VLRMM-E

Unit : mm

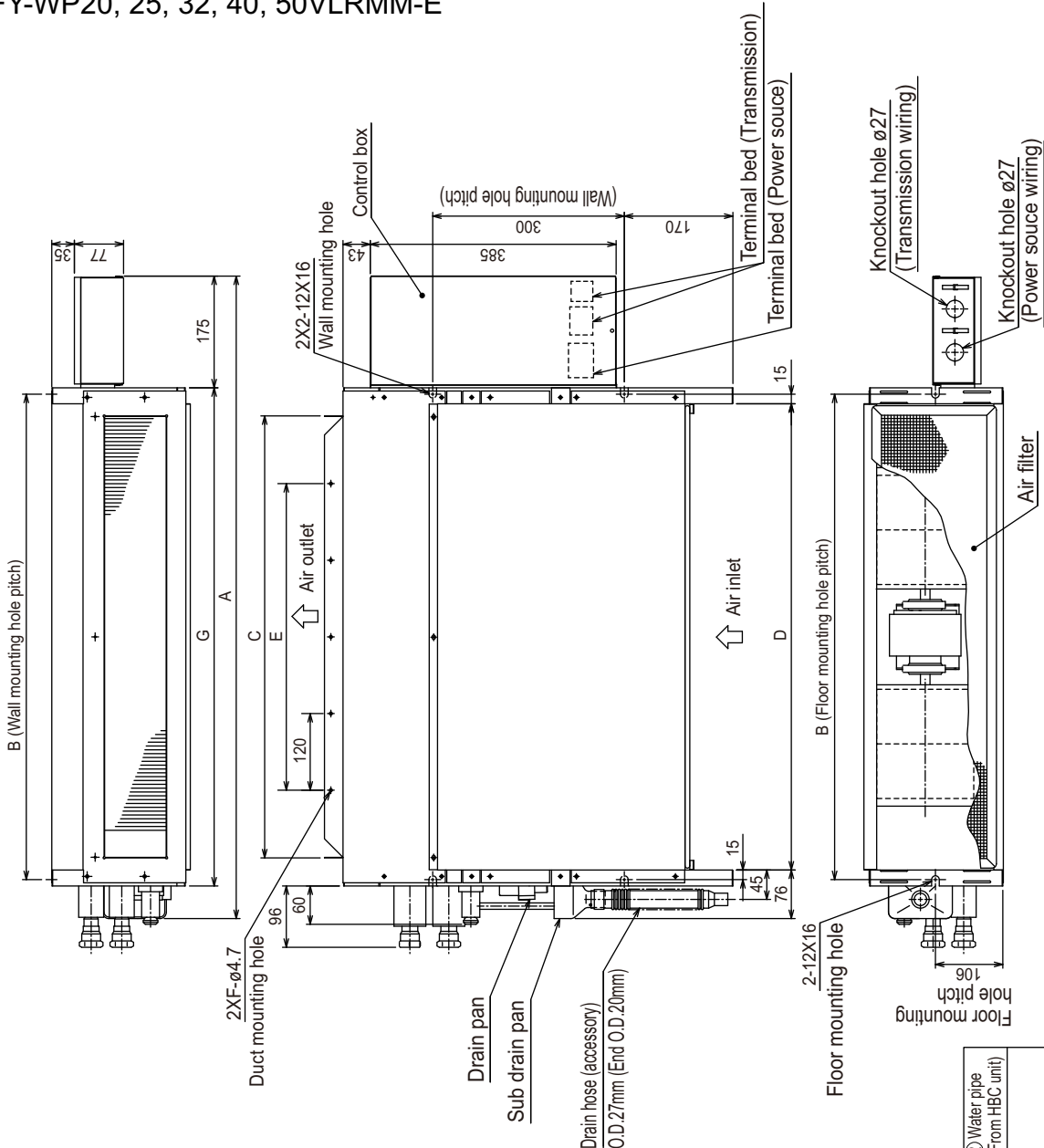

Model	① Water pipe (To HBC unit)		② Water pipe (From HBC unit)		Rc3/4 screw		
	A	B	C	D	E	F	
PFFY-WP20VLRMM-E	886	640	572	610	360	4	660
PFFY-WP25VLRMM-E	1006	760	692	730	480	5	780
PFFY-WP32VLRMM-E	1246	1000	932	970	720	7	1020

PFFY

3. CENTER OF GRAVITY

PFFY-WP20, 25, 32, 40, 50VLRMM-E

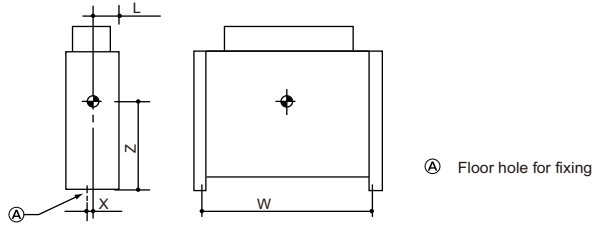

(mm)[in]

Model name	W	L	X	Z
PFFY-WP20VLRMM-E	640 [25-1/4]	100 [3-15/16]	17 [11/16]	335 [13-1/4]
PFFY-WP25VLRMM-E	760 [29-15/16]	100 [3-15/16]	17 [11/16]	335 [13-1/4]
PFFY-WP32VLRMM-E	760 [29-15/16]	100 [3-15/16]	17 [11/16]	335 [13-1/4]
PFFY-WP40VLRMM-E	1000 [39-3/8]	100 [3-15/16]	17 [11/16]	335 [13-1/4]
PFFY-WP50VLRMM-E	1000 [39-3/8]	100 [3-15/16]	17 [11/16]	335 [13-1/4]

4. ELECTRICAL WIRING DIAGRAMS

PFFY-WP20, 25, 32, 40, 50VLRMM-E

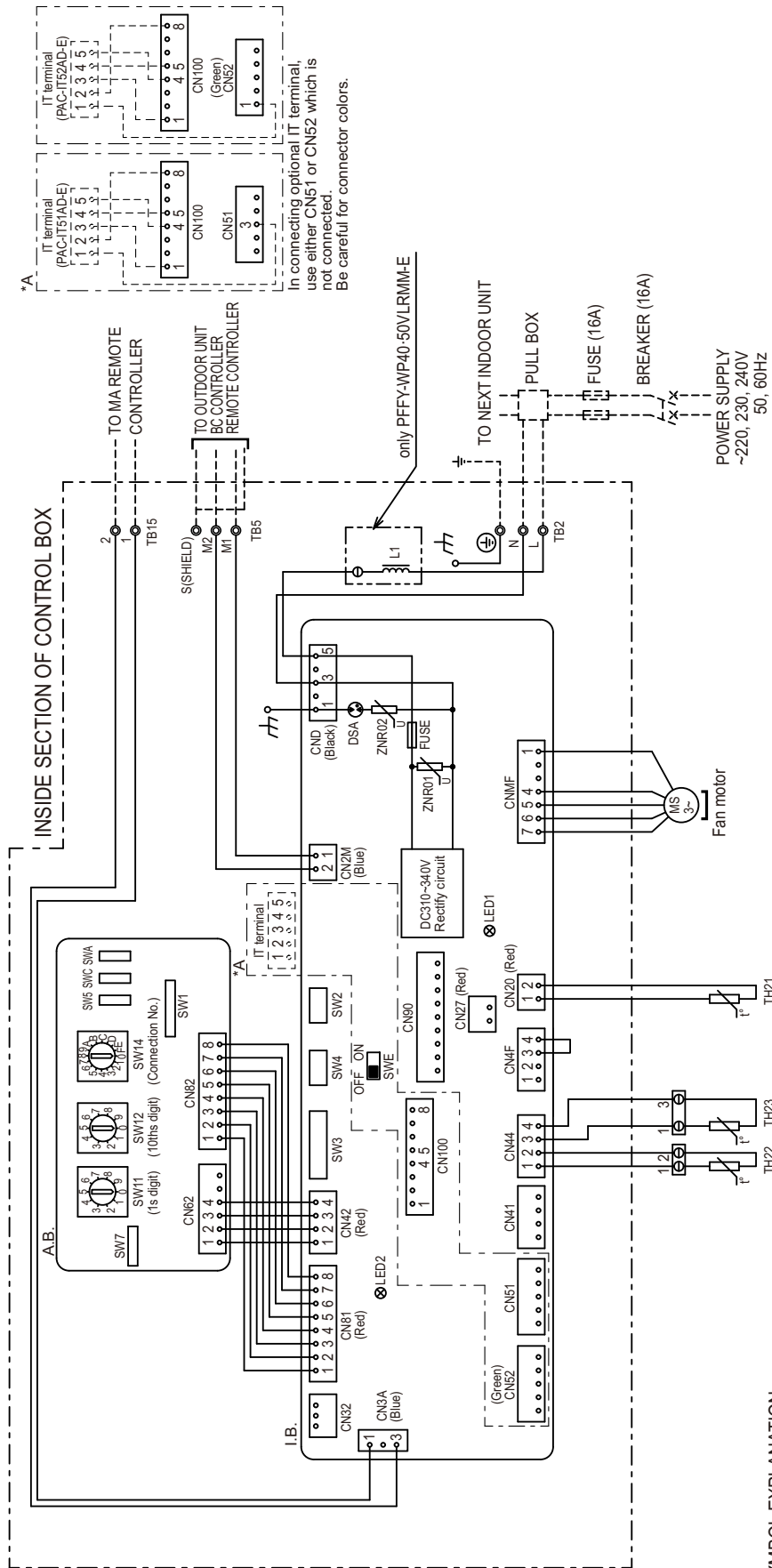

NOTE: Symbols used in wiring diagram above are,
 (HEAVY DOTTED LINE): FIELD WIRING
 (THIN DOTTED LINE): OPTIONAL PARTS
 ⊖ : CONNECTOR
 ⊙ : TERMINAL

OPERATION OF LED FOR INDOOR CIRCUIT BOARD SERVICE

SYMBOL	LED operation under normal state
LED1	At applying main power source → Lighting
LED2	At receiving MA transmission power source → Lighting

SYMBOL EXPLANATION

SYMBOL	NAME	SYMBOL	NAME
I.B.	Indoor controller board	A.B.	Address board
FUSE	Fuse <AC250V 6.3A>	SW1	Switch (for mode selection)
ZNR01,02	Varistor	SW5	Switch (for mode selection)
DSA	Arrester	SW7	Switch (for model selection)
CN27	Connector (Damper)	SW11	Switch (1s digit address set)
CN32	Connector (Remote switch)	SW12	Switch (10ths digit address set)
CN41	Connector (HA terminal-A)	SW14	Switch (connection No.set)
CN51	Connector (Centrally control)	SWA	Switch (for static pressure selection)
CN52	Connector (Remote indication)	SWC	Switch (for static pressure selection)
CN90	Connector (Wireless)	TB2	Power source terminal block
CN100	Connector (IT terminal)	TB5	Transmission terminal block
SW2	Switch (for capacity code)	TB15	Transmission terminal block
SW3	Switch (for mode selection)	TH21	Thermistor (inlet air temp.detection)
SW4	Switch (for model selection)	TH22	Thermistor (piping temp.detection/water in)
SWE	Connector (emergency operation)	TH23	Thermistor (piping temp.detection/water out)
L1	AC reactor(Power factor improvement)		

5. SOUND LEVELS

5-1. Sound levels

PFFY-WP-VLRMM-E

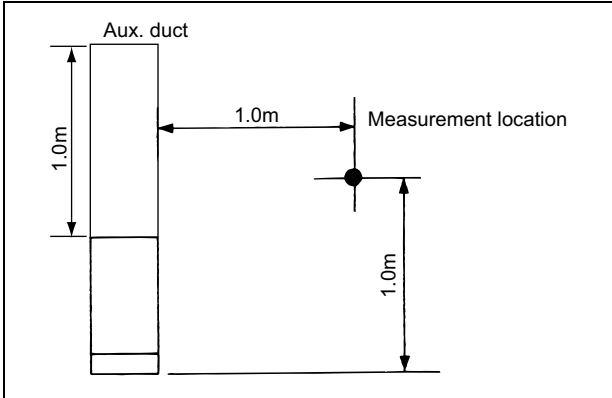

* Measured in anechoic room

Sound level at anechoic room : Low-Middle-High

	Sound level dB (A)		
	20Pa	40Pa	60Pa
PFFY-WP20VLRMM-E	31-33-38	32-37-39	36-38-42
PFFY-WP25VLRMM-E	31-33-38	32-37-39	36-38-42
PFFY-WP32VLRMM-E	31-35-38	34-37-40	36-40-42
PFFY-WP40VLRMM-E	34-37-40	37-39-43	37-41-44
PFFY-WP50VLRMM-E	37-42-45	38-44-47	39-45-48

5-2. NC curves

PFFY-WP20VLRMM-E
External Static Pressure: 20Pa
Power Source: 220-230-240V, 50/60Hz

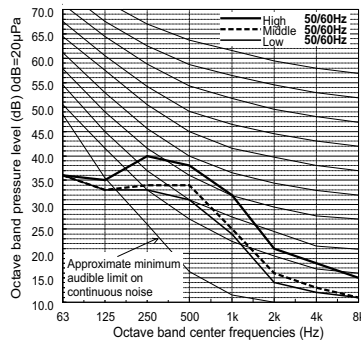

PFFY-WP20VLRMM-E
External Static Pressure: 40Pa
Power Source: 220-230-240V, 50/60Hz

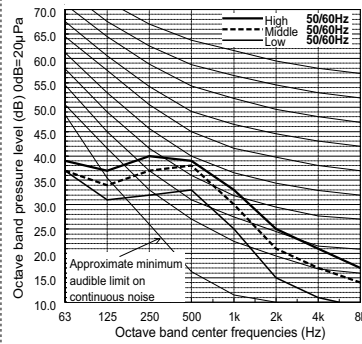

PFFY-WP20VLRMM-E
External Static Pressure: 60Pa
Power Source: 220-230-240V, 50/60Hz

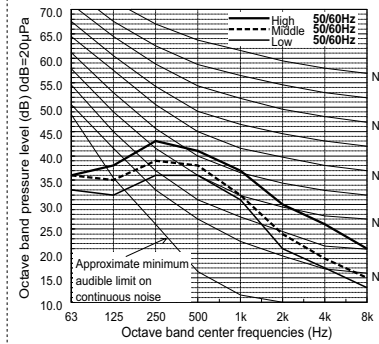

PFFY-WP25VLRMM-E
External Static Pressure: 20Pa
Power Source: 220-230-240V, 50/60Hz

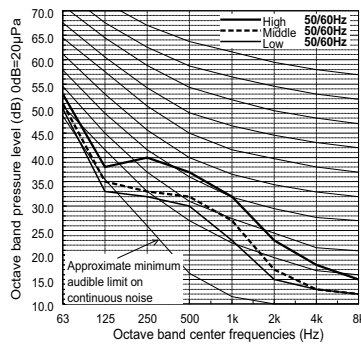

PFFY-WP25VLRMM-E
External Static Pressure: 40Pa
Power Source: 220-230-240V, 50/60Hz

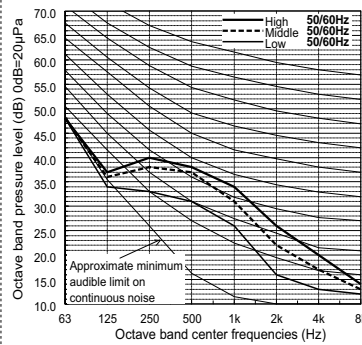

PFFY-WP25VLRMM-E
External Static Pressure: 60Pa
Power Source: 220-230-240V, 50/60Hz

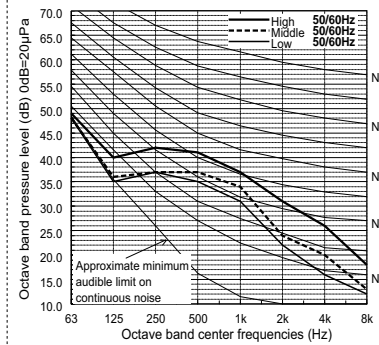

PFFY-WP32VLRMM-E
External Static Pressure: 20Pa
Power Source: 220-230-240V, 50/60Hz

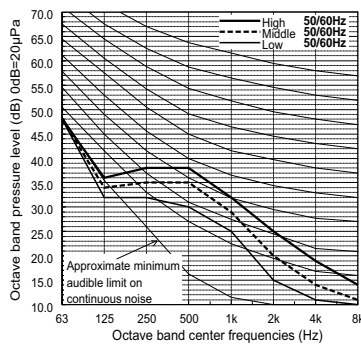

PFFY-WP32VLRMM-E
External Static Pressure: 40Pa
Power Source: 220-230-240V, 50/60Hz

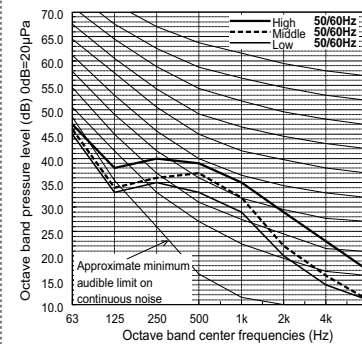

PFFY-WP32VLRMM-E
External Static Pressure: 60Pa
Power Source: 220-230-240V, 50/60Hz

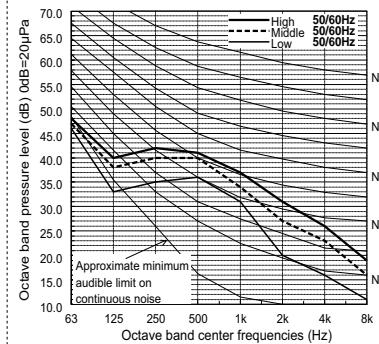

5. SOUND LEVELS

PFFY

PFFY-WP40VLRMM-E
 External Static Pressure: 20Pa
 Power Source: 220-230-240V, 50/60Hz

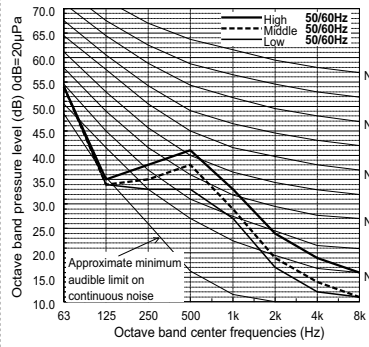

PFFY-WP40VLRMM-E
 External Static Pressure: 40Pa
 Power Source: 220-230-240V, 50/60Hz

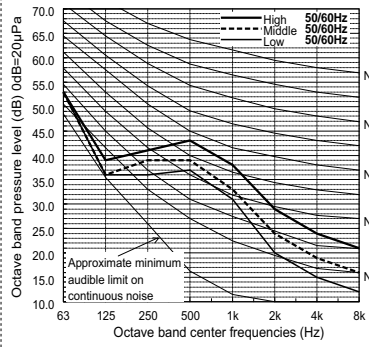

PFFY-WP40VLRMM-E
 External Static Pressure: 60Pa
 Power Source: 220-230-240V, 50/60Hz

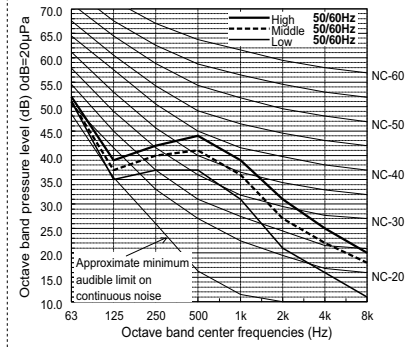

PFFY-WP50VLRMM-E
 External Static Pressure: 20Pa
 Power Source: 220-230-240V, 50/60Hz

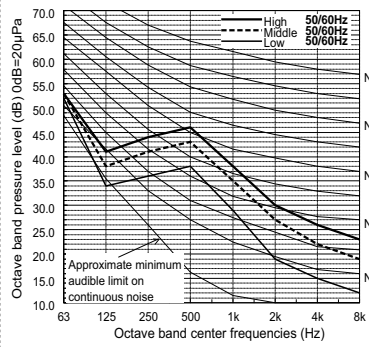

PFFY-WP50VLRMM-E
 External Static Pressure: 40Pa
 Power Source: 220-230-240V, 50/60Hz

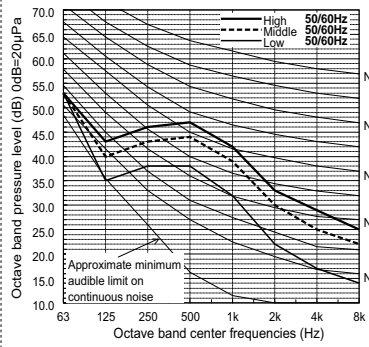

PFFY-WP50VLRMM-E
 External Static Pressure: 60Pa
 Power Source: 220-230-240V, 50/60Hz

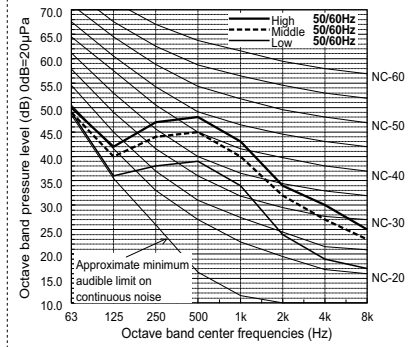

6. FAN CHARACTERISTICS CURVES

PFFY-WP20VLRMM-E

External static pressure : 20Pa
Power source : 220-230-240V, 50/60Hz

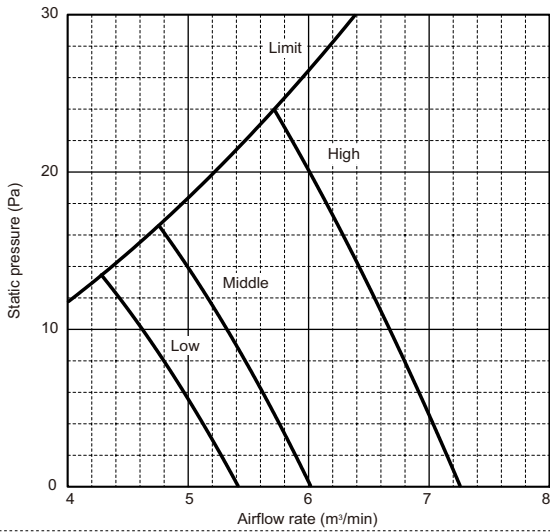

PFFY-WP20VLRMM-E

External static pressure : 40Pa
Power source : 220-230-240V, 50/60Hz

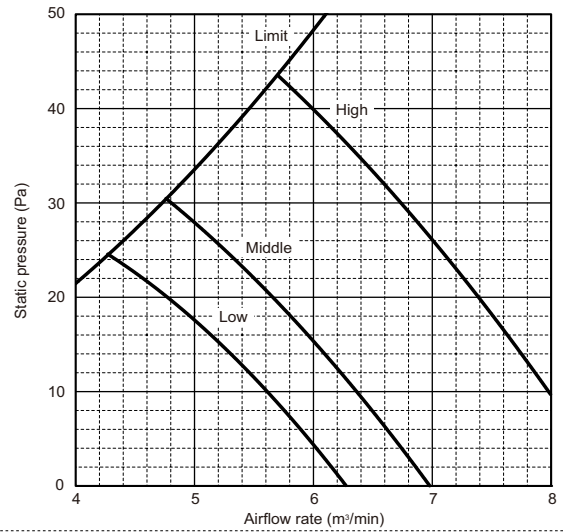

PFFY-WP20VLRMM-E

External static pressure : 60Pa
Power source : 220-230-240V, 50/60Hz

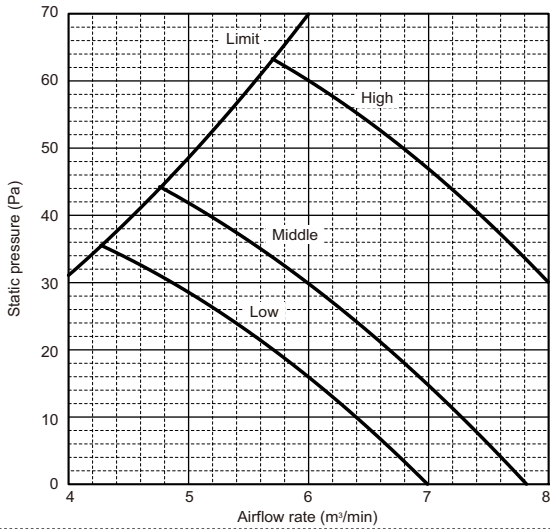

PFFY-WP25VLRMM-E

External static pressure : 20Pa
Power source : 220-230-240V, 50/60Hz

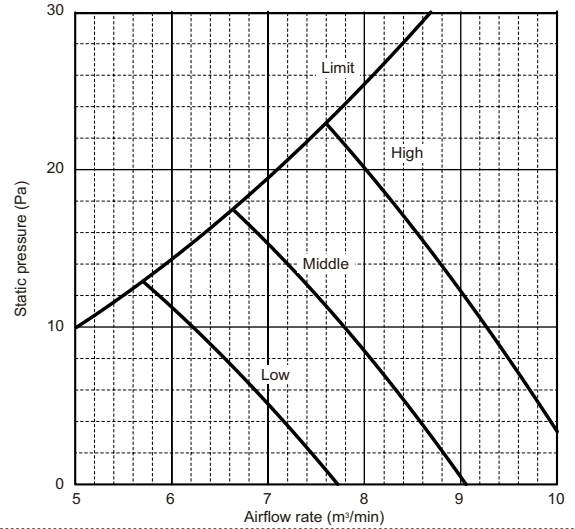

PFFY-WP25VLRMM-E

External static pressure : 40Pa
Power source : 220-230-240V, 50/60Hz

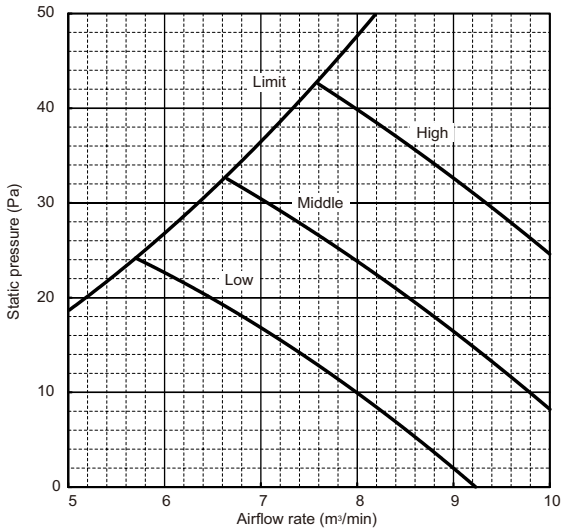

PFFY-WP25VLRMM-E

External static pressure : 60Pa
Power source : 220-230-240V, 50/60Hz

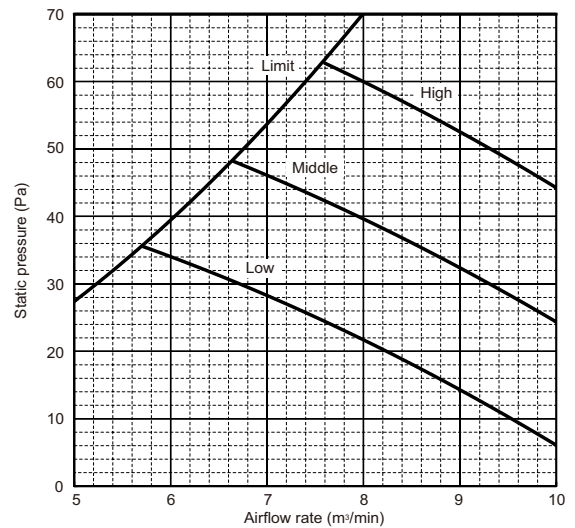

6. FAN CHARACTERISTICS CURVES

PFFY

PFFY-WP32VLRMM-E

External static pressure : 20Pa
Power source : 220-230-240V, 50/60Hz

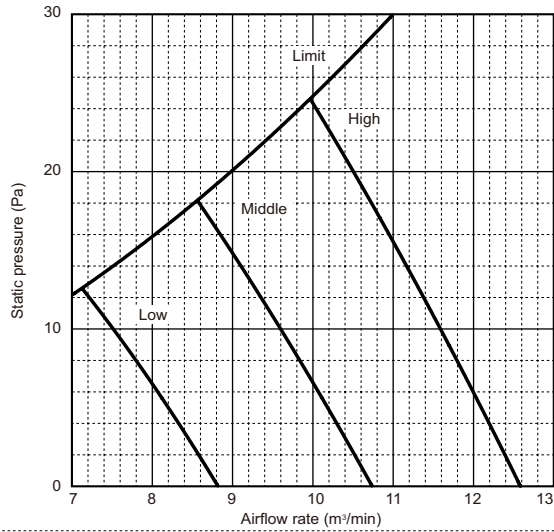

PFFY-WP32VLRMM-E

External static pressure : 40Pa
Power source : 220-230-240V, 50/60Hz

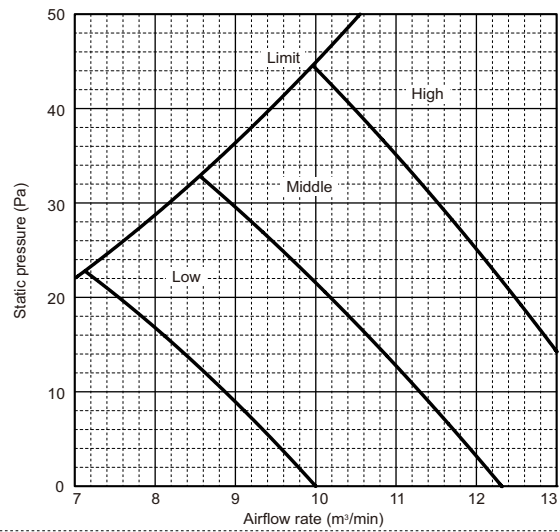

PFFY-WP32VLRMM-E

External static pressure : 60Pa
Power source : 220-230-240V, 50/60Hz

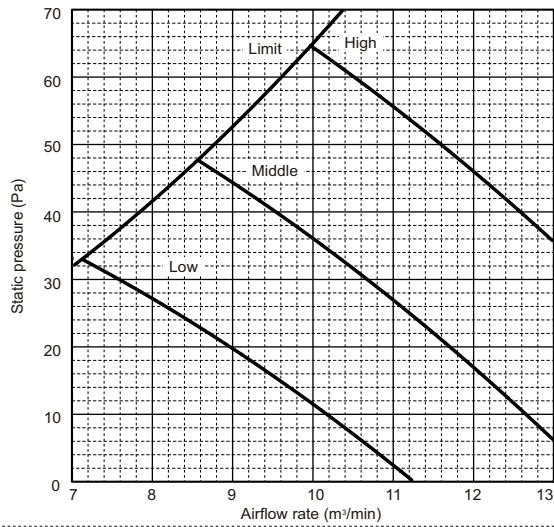

PFFY-WP40VLRMM-E

External static pressure : 20Pa
Power source : 220-230-240V, 50/60Hz

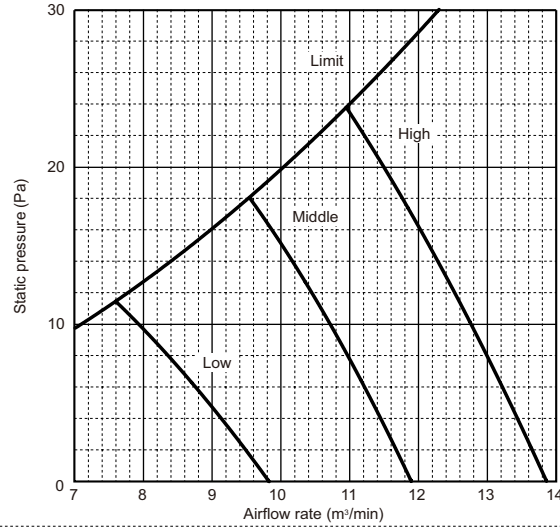

PFFY-WP40VLRMM-E

External static pressure : 40Pa
Power source : 220-230-240V, 50/60Hz

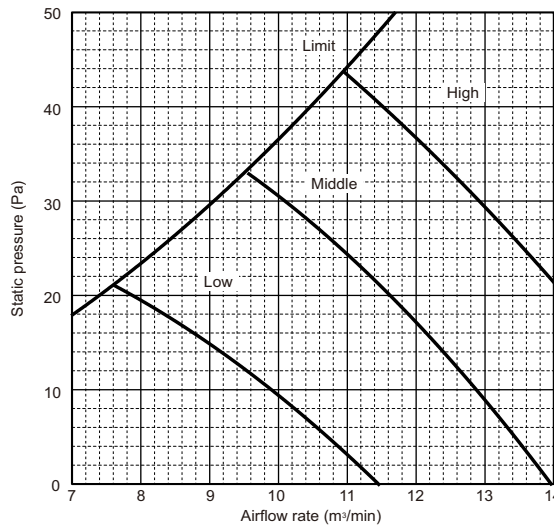

PFFY-WP40VLRMM-E

External static pressure : 60Pa
Power source : 220-230-240V, 50/60Hz

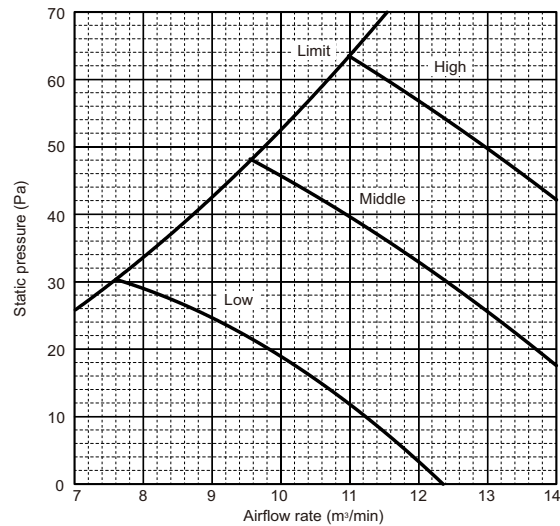

6. FAN CHARACTERISTICS CURVES

PFFY-WP50VLRMM-E

External static pressure : 20Pa

Power source : 220-230-240V, 50/60Hz

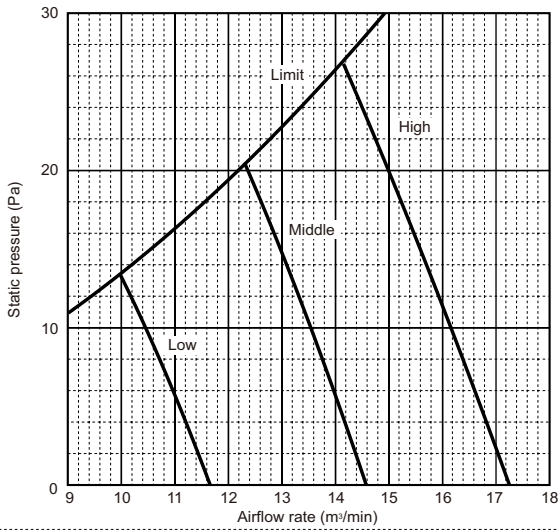

PFFY-WP50VLRMM-E

External static pressure : 40Pa

Power source : 220-230-240V, 50/60Hz

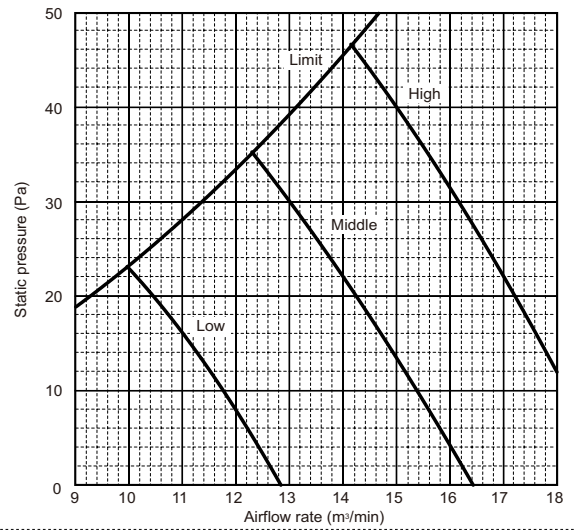

PFFY-WP50VLRMM-E

External static pressure : 60Pa

Power source : 220-230-240V, 50/60Hz

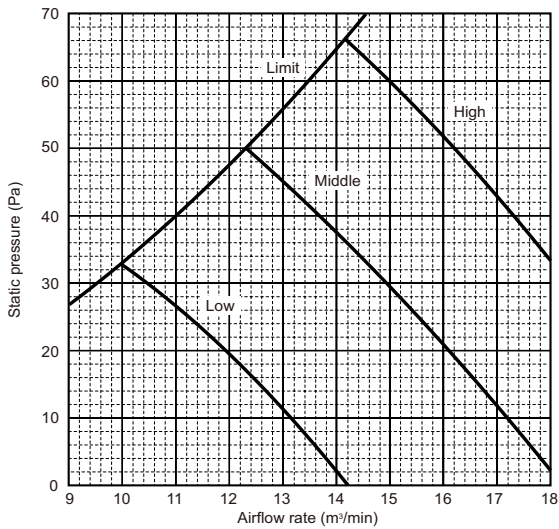

CMB-WP-V-GA1, CMB-WP-V-GB1 (for YLM series only)

1. SPECIFICATIONS	1 - 62
2. EXTERNAL DIMENSIONS	1 - 66
3. CENTER OF GRAVITY	1 - 70
4. ELECTRICAL WIRING DIAGRAMS	1 - 71
5. SOUND LEVELS	1 - 75
5-1. Sound levels	1 - 75
5-2. NC curves	1 - 75

1. SPECIFICATIONS

Model name			CMB-WP108V-GA1				
Number of branch			8				
Power source			1-phase 220-230-240 V				
			50 Hz		60 Hz		
Power input (220/230/240)	Cooling	kW	0.45/0.46/0.47			0.45/0.46/0.47	
	Heating	kW	0.45/0.46/0.47			0.45/0.46/0.47	
Current input (220/230/240)	Cooling	A	2.89/2.83/2.79			2.89/2.83/2.79	
	Heating	A	2.89/2.83/2.79			2.89/2.83/2.79	
Sound pressure level (measured in anechoic room)		dB <A>	41				
Applicable temperature range of installation site		°C (D.B.)	0~32				
External finish			Galvanized steel plate (Lower part drain pan: Pre-coated galvanized sheets + powder coating)				
Connectable outdoor unit			PURY-P200~500YLM-A1(-BS)/PURY-EP200~500YLM-A1(-BS) *a				
Indoor unit capacity connectable to 1 branch			Model P80 or smaller (Use optional joint pipe combing 2 branches when the total unit capacity exceeds P81)				
External dimension H x W x D		mm	300 x 1,520 x 630				
		in.	11-13/16 x 59-7/8 x 24-13/16				
Refrigerant piping diameter	To outdoor unit		Connectable outdoor unit capacity				
			To P200	To P250/300	To P350	To P400 for each	To P450/500 for each
	High press. Pipe	mm (in.) O.D.	15.88 (5/8) Braze	19.05 (3/4) Braze	19.05 (3/4) Braze	15.88 (5/8) Braze	19.05 (3/4) Braze
Low press. Pipe	mm (in.) O.D.	19.05 (3/4) Braze	22.2 (7/8) Braze	28.58 (1-1/8) Braze	19.05 (3/4) Braze	22.2 (7/8) Braze	
Water piping diameter	To Indoor unit						
	Inlet Pipe	mm I.D.	20				
	Outlet Pipe	mm I.D.	20				
Field drain pipe size		mm (in.)	O.D. 32 (1-1/4)				
Net weight		kg (lbs)	85 (188) [95 (210) with water]				
Standard attachment	Document		-				
	Accessory		Drain Connection pipe (with flexible hose and insulation)				
Optional parts			-				
Note	<p>1.Works not included: Installation/foundation work, electrical connection work, duct work, insulation work, power source switch, and other items are not specified in this specifications.</p> <p>2.The equipment is for R410A refrigerant.</p> <p>3.Install this product in a location where noise (refrigerant noise) emitted by the unit will not disturb the neighbors. (For use in quiet environments with low background noise, position the HBC CONTROLLER at least 5 m away from any indoor units.)</p> <p>4.Please install the HBC controller in a place where noise will not be an issue.</p> <p>5.Please attach an expansion vessel (field supply).</p> <p>6.Please use copper or plastic pipes for the water circuit. Do not use steel or stainless steel pipework. Furthermore, when using copper pipework use a non-oxidative brazing method. Oxidation of the pipework will reduce the pump life.</p> <p>7.When blazing the pipes, be sure to blaze, after covering a wet cloth to the insulation pipes of the units in order to prevent it from burning and shrinking by heat.</p> <p>8.Please install an air purge valve where air will gather in the water circuit.</p> <p>9.Please install a pressure reducing valve and a strainer on the water supply to the HBC controller.</p> <p>10.Please refer to the databook or the installation manual for the specified water quality.</p> <p>11.This unit is not designed for outside installations.</p> <p>12.Please always make water circulate or pull out the circulation water completely when not using it. *Please do not use it as a drinking water.</p> <p>13.Please do not use ground water and well water.</p> <p>14.When installing the HBC unit in an environment which may drop below 0 °C, please add antifreeze to the circulating water. (Refer to the databook and the installation manual).</p>						

*a. Cannot be connected to other than YLM series

1. SPECIFICATIONS

Model name			CMB-WP1016V-GA1				
Number of branch			16				
Power source			1-phase 220-230-240 V				
			50 Hz			60 Hz	
Power input (220/230/240)	Cooling	kW	0.45/0.46/0.47			0.45/0.46/0.47	
	Heating	kW	0.45/0.46/0.47			0.45/0.46/0.47	
Current input (220/230/240)	Cooling	A	2.89/2.83/2.79			2.89/2.83/2.79	
	Heating	A	2.89/2.83/2.79			2.89/2.83/2.79	
Sound pressure level (measured in anechoic room)		dB <A>	41				
Applicable temperature range of installation site		°C (D.B.)	0-32				
External finish			Galvanized steel plate (Lower part drain pan: Pre-coated galvanized sheets + powder coating)				
Connectable outdoor unit			PURY-P200-500YLM-A1(-BS)/PURY-EP200-500YLM-A1(-BS) *a				
Indoor unit capacity connectable to 1 branch			Model P80 or smaller (Use optional joint pipe combing 2 branches when the total unit capacity exceeds P81)				
External dimension H x W x D		mm	300 x 1,800 x 630				
		in.	11-13/16 x 70-7/8 x 24-13/16				
Refrigerant piping diameter	To outdoor unit		Connectable outdoor unit capacity				
	High press. Pipe	mm (in.) O.D.	To P200	To P250/300	To P350	To P400 for each	To P450/500 for each
		mm (in.) O.D.	15.88 (5/8) Brazed	19.05 (3/4) Brazed	19.05 (3/4) Brazed	15.88 (5/8) Brazed	19.05 (3/4) Brazed
Low press. Pipe	mm (in.) O.D.	19.05 (3/4) Brazed	22.2 (7/8) Brazed	28.58 (1-1/8) Brazed	19.05 (3/4) Brazed	22.2 (7/8) Brazed	
Water piping diameter	To Indoor unit						
	Inlet Pipe	mm I.D.	20				
	Outlet Pipe	mm I.D.	20				
Field drain pipe size		mm (in.)	O.D. 32 (1-1/4)				
Net weight		kg (lbs)	97 (214) [110 (243) with water]				
Standard attachment	Document		-				
	Accessory		Drain Connection pipe (with flexible hose and insulation)				
Optional parts			-				
Note	<p>1.Works not included: Installation/foundation work, electrical connection work, duct work, insulation work, power source switch, and other items are not specified in this specifications.</p> <p>2.The equipment is for R410A refrigerant.</p> <p>3.Install this product in a location where noise (refrigerant noise) emitted by the unit will not disturb the neighbors. (For use in quiet environments with low background noise, position the HBC CONTROLLER at least 5 m away from any indoor units.)</p> <p>4.Please install the HBC controller in a place where noise will not be an issue.</p> <p>5.Please attach an expansion vessel (field supply).</p> <p>6.Please use copper or plastic pipes for the water circuit. Do not use steel or stainless steel pipework. Furthermore, when using copper pipework use a non-oxidative brazing method. Oxidation of the pipework will reduce the pump life.</p> <p>7.When brazing the pipes, be sure to blaze, after covering a wet cloth to the insulation pipes of the units in order to prevent it from burning and shrinking by heat.</p> <p>8.Please install an air purge valve where air will gather in the water circuit.</p> <p>9.Please install a pressure reducing valve and a strainer on the water supply to the HBC controller.</p> <p>10.Please refer to the databook or the installation manual for the specified water quality.</p> <p>11.This unit is not designed for outside installations.</p> <p>12.Please always make water circulate or pull out the circulation water completely when not using it. *Please do not use it as a drinking water.</p> <p>13.Please do not use ground water and well water.</p> <p>14.When installing the HBC unit in an environment which may drop below 0 °C, please add antifreeze to the circulating water. (Refer to the databook and the installation manual).</p>						

*a. Cannot be connected to other than YLM series

1. SPECIFICATIONS

Model name			CMB-WP108V-GB1				
Number of branch			8				
Power source			1-phase 220-230-240 V				
			50 Hz		60 Hz		
Power input (220/230/240)	Cooling	kW	0.01/0.01/0.01		0.01/0.01/0.01		
	Heating	kW	0.01/0.01/0.01		0.01/0.01/0.01		
Current input (220/230/240)	Cooling	A	0.05/0.05/0.05		0.05/0.05/0.05		
	Heating	A	0.05/0.05/0.05		0.05/0.05/0.05		
Sound pressure level (measured in anechoic room)		dB <A>	-				
Applicable temperature range of installation site		°C (D.B.)	0~32				
External finish			Galvanized steel plate (Lower part drain pan: Pre-coated galvanized sheets + powder coating)				
Connectable outdoor unit			-				
Indoor unit capacity connectable to 1 branch			Model P80 or smaller (Use optional joint pipe combing 2 branches when the total unit capacity exceeds P81)				
External dimension H x W x D		mm	300 x 1,520 x 630				
		in.	11-13/16 x 59-7/8 x 24-13/16				
Refrigerant piping diameter	To outdoor unit		Connectable outdoor unit capacity				
	High press. Pipe	mm (in.) O.D.	-	-	-	-	-
	Low press. Pipe	mm (in.) O.D.	-	-	-	-	-
Water piping diameter	To Indoor unit						
	Inlet Pipe	mm I.D.	20				
	Outlet Pipe	mm I.D.	20				
Field drain pipe size		mm (in.)	O.D. 32 (1-1/4)				
Net weight		kg (lbs)	43 (95) [48 (106) with water]				
Standard attachment	Document		-				
	Accessory		Drain Connection pipe (with flexible hose and insulation)				
Optional parts			-				
Note	<p>1.Works not included: Installation/foundation work, electrical connection work, duct work, insulation work, power source switch, and other items are not specified in this specifications.</p> <p>2.The equipment is for water.</p> <p>3.Install this product in a location where noise (refrigerant noise) emitted by the unit will not disturb the neighbors. (For use in quiet environments with low background noise, position the Sub HBC CONTROLLER at least 5 m away from any indoor units.)</p> <p>4.Please install the Sub HBC controller in a place where noise will not be an issue.</p> <p>5.Please attach an expansion vessel (field supply).</p> <p>6.Please use copper or plastic pipes for the water circuit. Do not use steel or stainless steel pipework. Furthermore, when using copper pipework use a non-oxidative brazing method. Oxidation of the pipework will reduce the pump life.</p> <p>7.When blazing the pipes, be sure to blaze, after covering a wet cloth to the insulation pipes of the units in order to prevent it from burning and shrinking by heat.</p> <p>8.Please install an air purge valve where air will gather in the water circuit.</p> <p>9.Please refer to the databook or the installation manual for the specified water quality.</p> <p>10.This unit is not designed for outside installations.</p> <p>11.Please always make water circulate or pull out the circulation water completely when not using it. *Please do not use it as a drinking water.</p> <p>12.Please do not use ground water and well water.</p> <p>13.When installing the Sub HBC unit in an environment which may drop below 0 °C, please add antifreeze to the circulating water. (Refer to the databook and the installation manual).</p> <p>14.Can't use singleness. (MAIN HBC CONTROLLER is necessary)</p>						

HBC

1. SPECIFICATIONS

Model name			CMB-WP1016V-GB1				
Number of branch			16				
Power source			1-phase 220-230-240 V				
			50 Hz		60 Hz		
Power input (220/230/240)	Cooling	kW	0.01/0.01/0.01		0.01/0.01/0.01		
	Heating	kW	0.01/0.01/0.01		0.01/0.01/0.01		
Current input (220/230/240)	Cooling	A	0.05/0.05/0.05		0.05/0.05/0.05		
	Heating	A	0.05/0.05/0.05		0.05/0.05/0.05		
Sound pressure level (measured in anechoic room)		dB <A>	-				
Applicable temperature range of installation site		°C (D.B.)	0-32				
External finish			Galvanized steel plate (Lower part drain pan: Pre-coated galvanized sheets + powder coating)				
Connectable outdoor unit			-				
Indoor unit capacity connectable to 1 branch			Model P80 or smaller (Use optional joint pipe combing 2 branches when the total unit capacity exceeds P81)				
External dimension H x W x D		mm	300 x 1,520 x 630				
		in.	11-13/16 x 59-7/8 x 24-13/16				
Refrigerant piping diameter	To outdoor unit		Connectable outdoor unit capacity				
			-	-	-	-	-
	High press. Pipe	mm (in.) O.D.	-	-	-	-	-
	Low press. Pipe	mm (in.) O.D.	-	-	-	-	-
Water piping diameter	To Indoor unit						
	Inlet Pipe	mm I.D.	20				
	Outlet Pipe	mm I.D.	20				
Field drain pipe size		mm (in.)	O.D. 32 (1-1/4)				
Net weight		kg (lbs)	51 (113) [60 (133) with water]				
Standard attachment	Document		-				
	Accessory		Drain Connection pipe (with flexible hose and insulation)				
Optional parts			-				
Note			<p>1.Works not included: Installation/foundation work, electrical connection work, duct work, insulation work, power source switch, and other items are not specified in this specifications.</p> <p>2.The equipment is for water.</p> <p>3.Install this product in a location where noise (refrigerant noise) emitted by the unit will not disturb the neighbors. (For use in quiet environments with low background noise, position the Sub HBC CONTROLLER at least 5 m away from any indoor units.)</p> <p>4.Please install the Sub HBC controller in a place where noise will not be an issue.</p> <p>5.Please attach an expansion vessel (field supply).</p> <p>6.Please use copper or plastic pipes for the water circuit. Do not use steel or stainless steel pipework. Furthermore, when using copper pipework use a non-oxidative brazing method. Oxidation of the pipework will reduce the pump life.</p> <p>7.When brazing the pipes, be sure to blaze, after covering a wet cloth to the insulation pipes of the units in order to prevent it from burning and shrinking by heat.</p> <p>8.Please install an air purge valve where air will gather in the water circuit.</p> <p>9.Please refer to the databook or the installation manual for the specified water quality.</p> <p>10.This unit is not designed for outside installations.</p> <p>11.Please always make water circulate or pull out the circulation water completely when not using it. *Please do not use it as a drinking water.</p> <p>12.Please do not use ground water and well water.</p> <p>13.When installing the Sub HBC unit in an environment which may drop below 0 °C, please add antifreeze to the circulating water. (Refer to the databook and the installation manual).</p> <p>14.Can't use singleness. (MAIN HBC CONTROLLER is necessary)</p>				

2. EXTERNAL DIMENSIONS

CMB-WP108V-GA1

Unit : mm

HBC

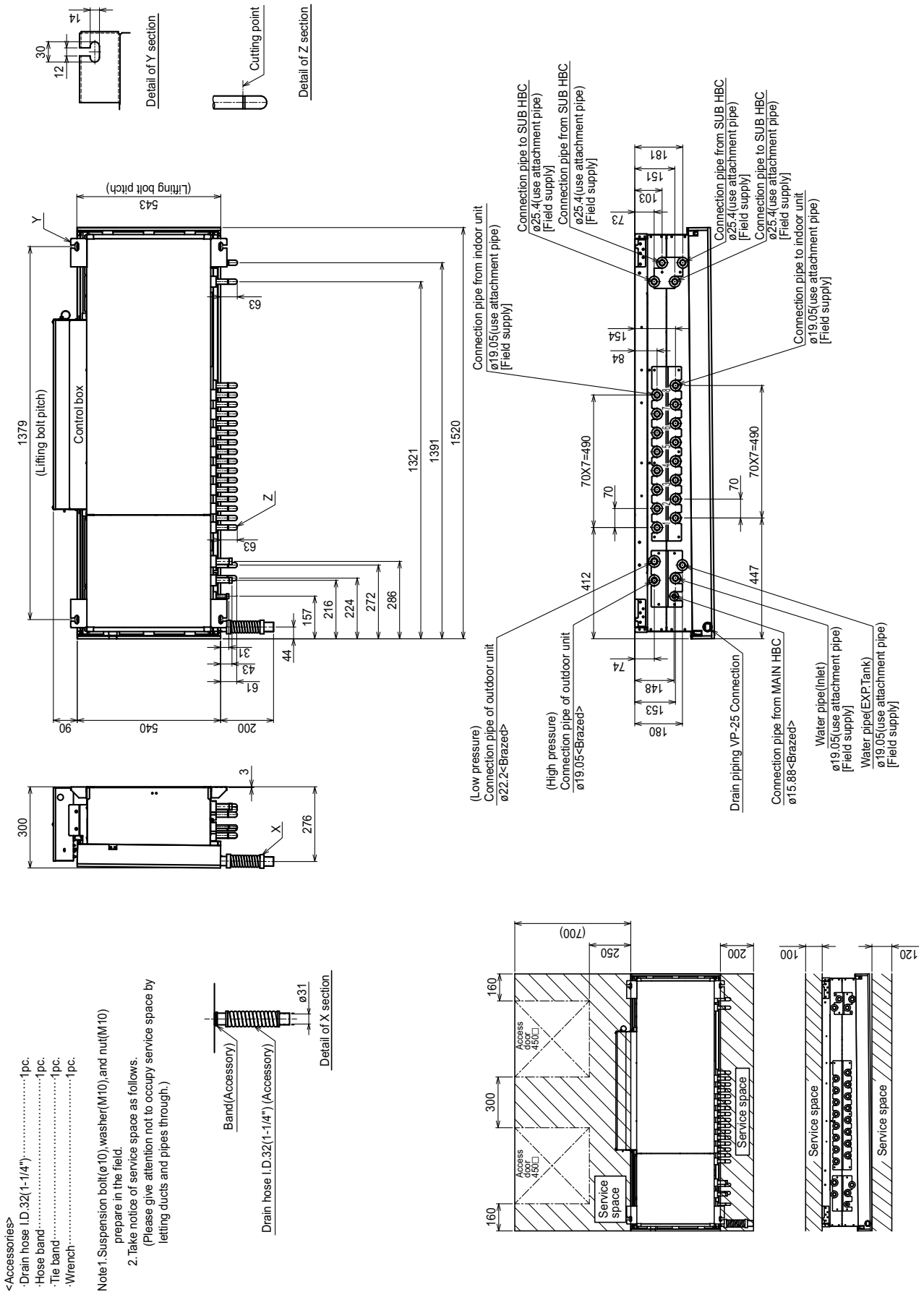

2. EXTERNAL DIMENSIONS

CMB-WP1016V-GA1

Unit : mm

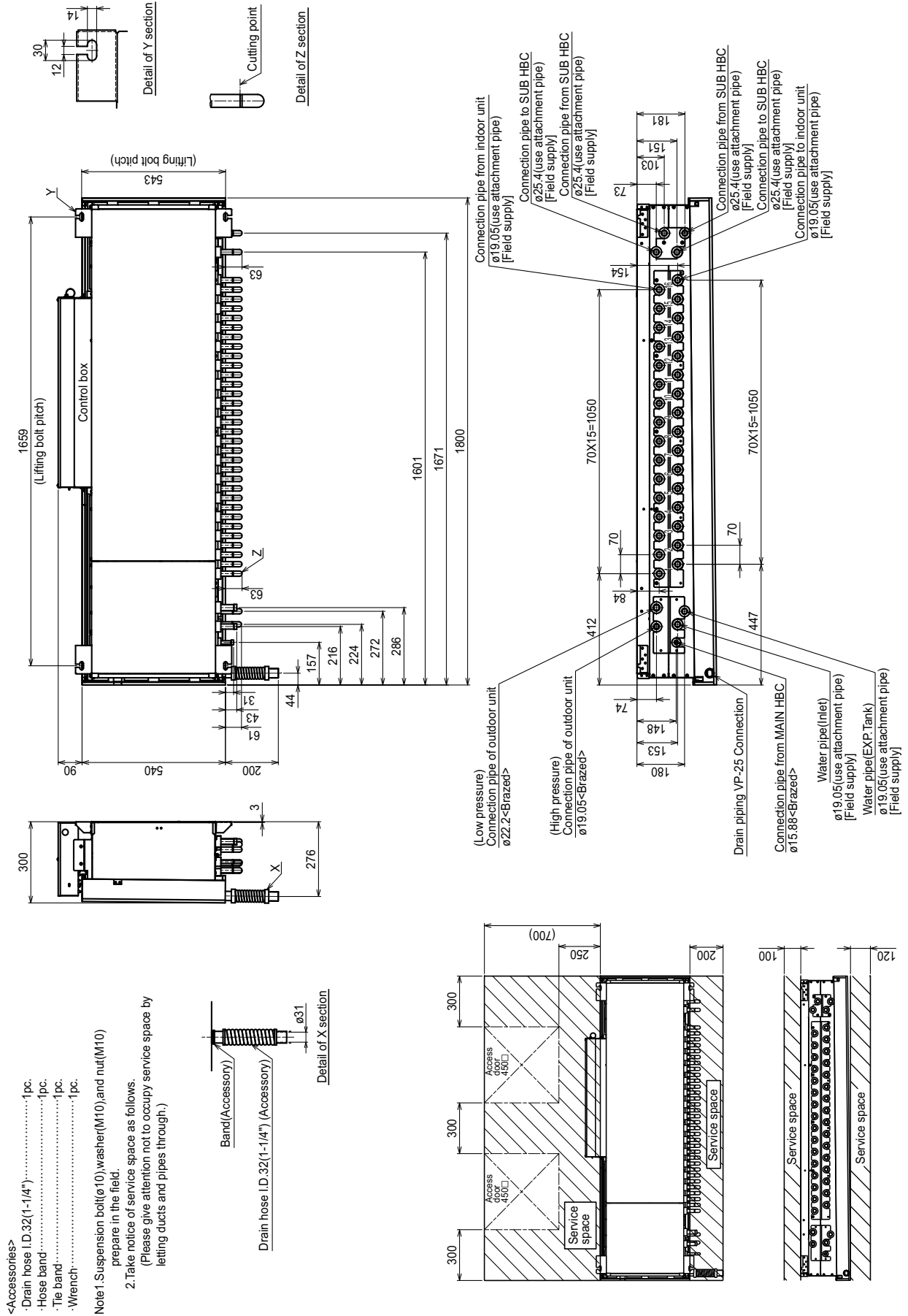

HBC

2. EXTERNAL DIMENSIONS

CMB-WP108V-GB1

Unit : mm

HBC

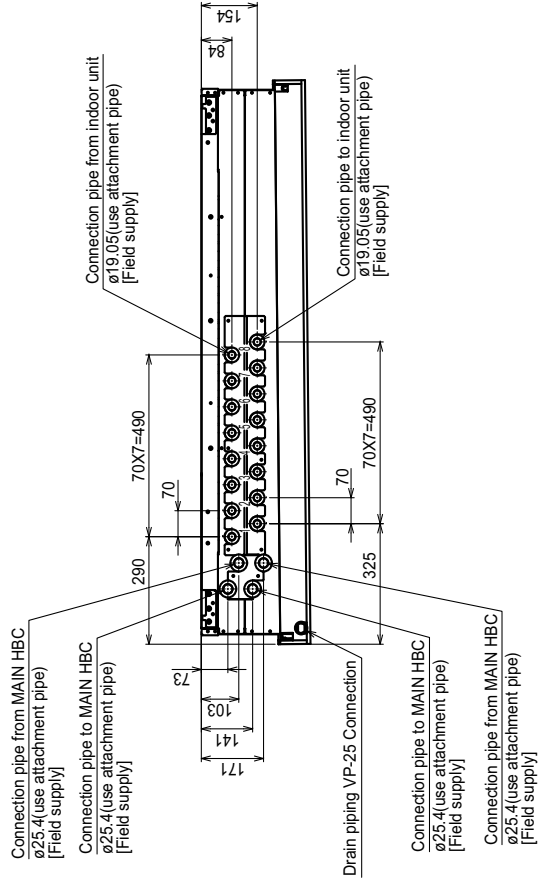
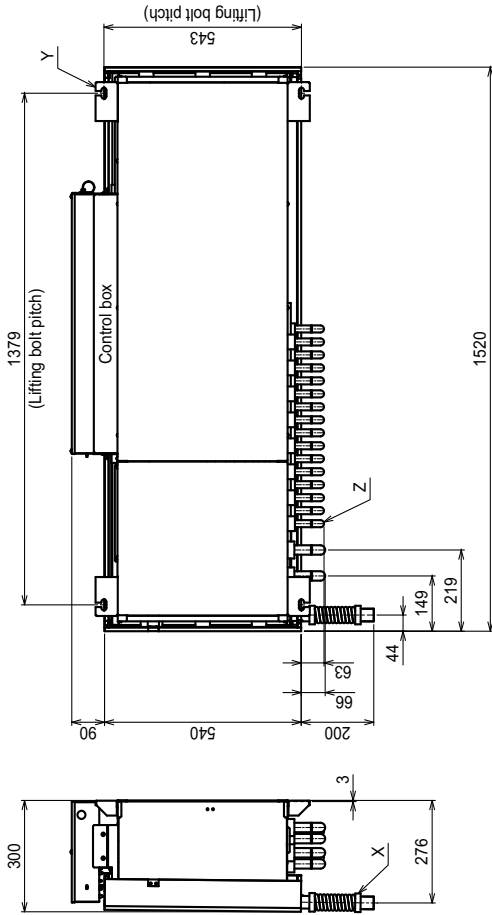
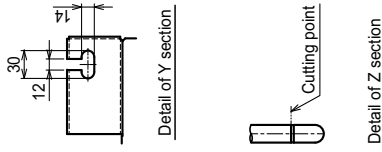

- <Accessories>
 · Drain hose I.D. 32(1-1/4").....1pc.
 · Hose band.....1pc.
 · Tie band.....1pc.
 Note 1. Suspension bolt(ø10), washer(M10), and nut(M10) prepare in the field.
 2. Take notice of service space as follows.
 (Please give attention not to occupy service space by letting ducts and pipes through.)

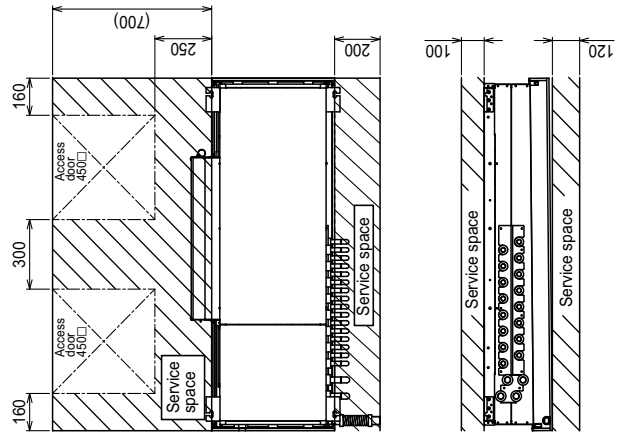

2. EXTERNAL DIMENSIONS

CMB-WP1016V-GB1

Unit : mm

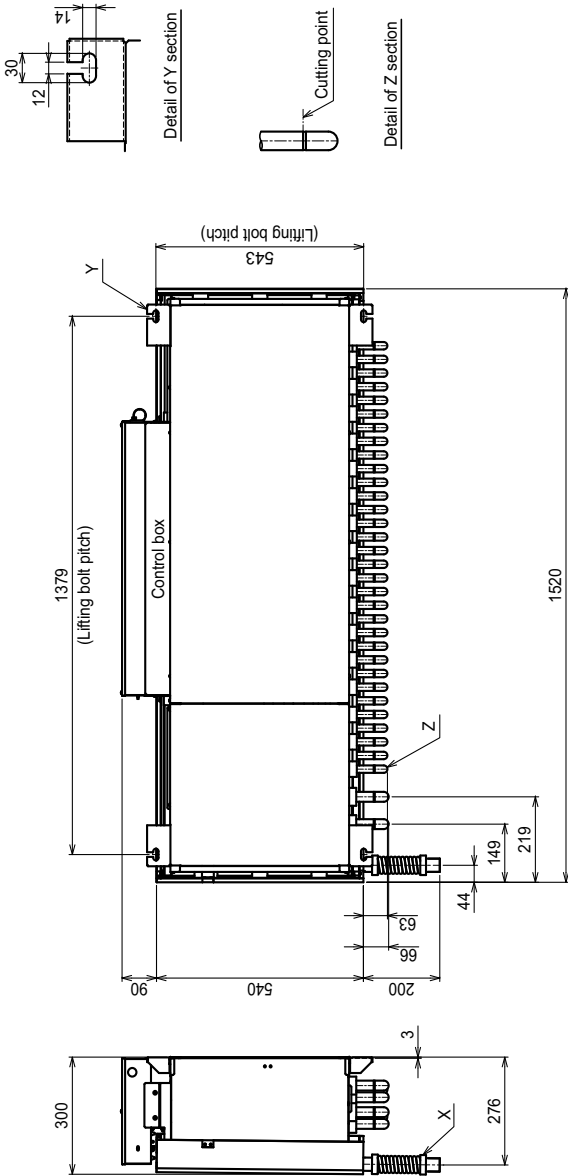

- <Accessories>
- Drain hose I.D. 32(1-1/4").....1pc.
 - Hose band.....1pc.
 - Tie band.....1pc.
- Note 1. Suspension bolt(φ10), washer(M10), and nut(M10) prepare in the field.
 2. Take notice of service space as follows.
 (Please give attention not to occupy service space by letting ducts and pipes through.)

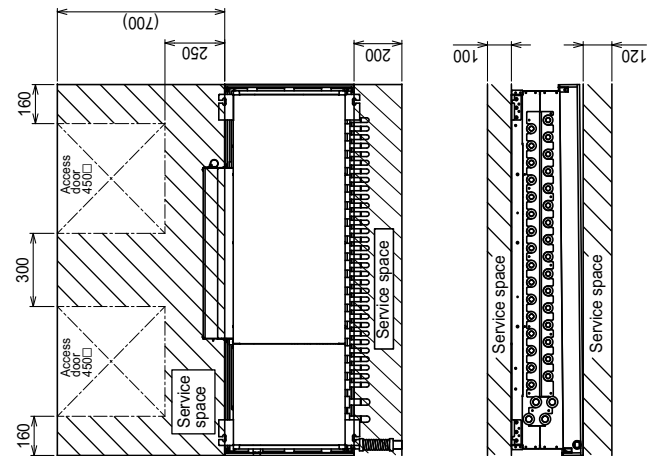
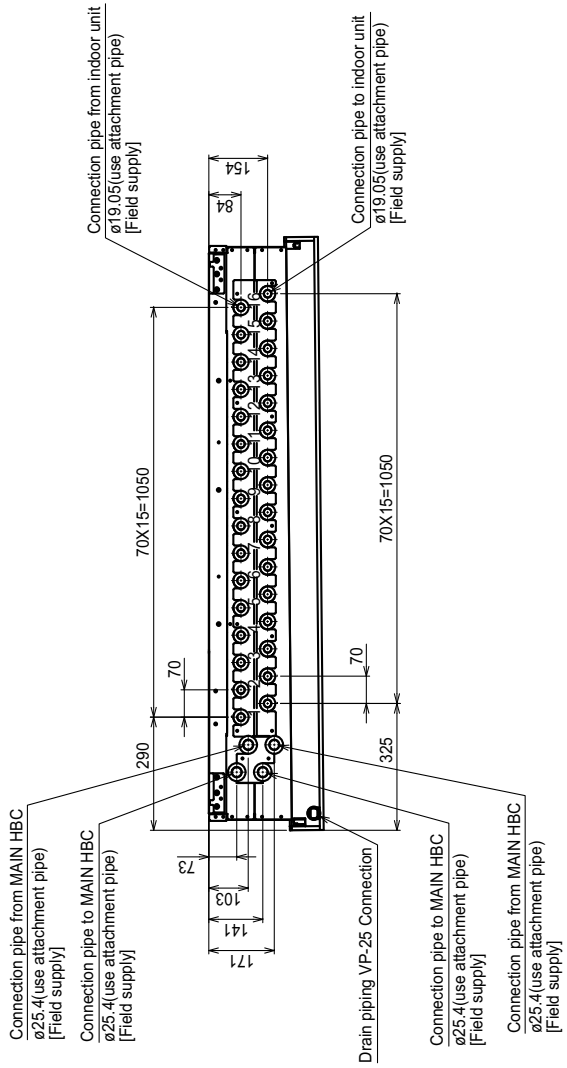
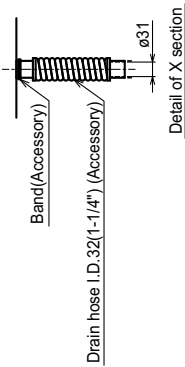

HBC

3. CENTER OF GRAVITY

CMB-WP108, 1016V-GA1
 CMB-WP108, 1016V-GB1

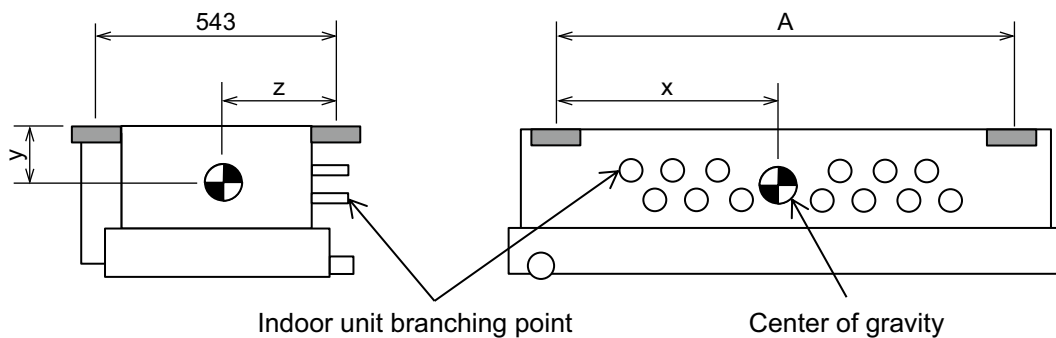

	CMB-WP108V-GA1	CMB-WP1016V-GA1	CMB-WP108V-GB1	CMB-WP1016V-GB1
A (mm)	1379	1659	1379	1379
x (mm)	680	825	610	680
y (mm)	145	145	145	145
z (mm)	285	285	270	270

4. ELECTRICAL WIRING DIAGRAMS

CMB-WP108V-GA1

(Symbol explanation)

Symbol	Name	Symbol	Name
ACL	AC reactor	SV1	Solenoid valve
TH11~16, TH32~35	Thermister sensor	F001	Fuse AC250V 6.3A F
TH31a~h	Expansion valve	271SAMa, 21SAMb	4 way valve
LEV1~3	Pressure sensor	WP1, WP2	Pump
PS1, PS3	Terminal block (for power source)	VB3a~h	Valve block
TB01	Terminal block (for Transmission)	FS	Float switch
TB02			

NOTE: 1. TB02 is transmission terminal block.

Never connect power line to it.

2. The initial set values of switch on Control Board are as follows.

SW1: 0

SW2: 0

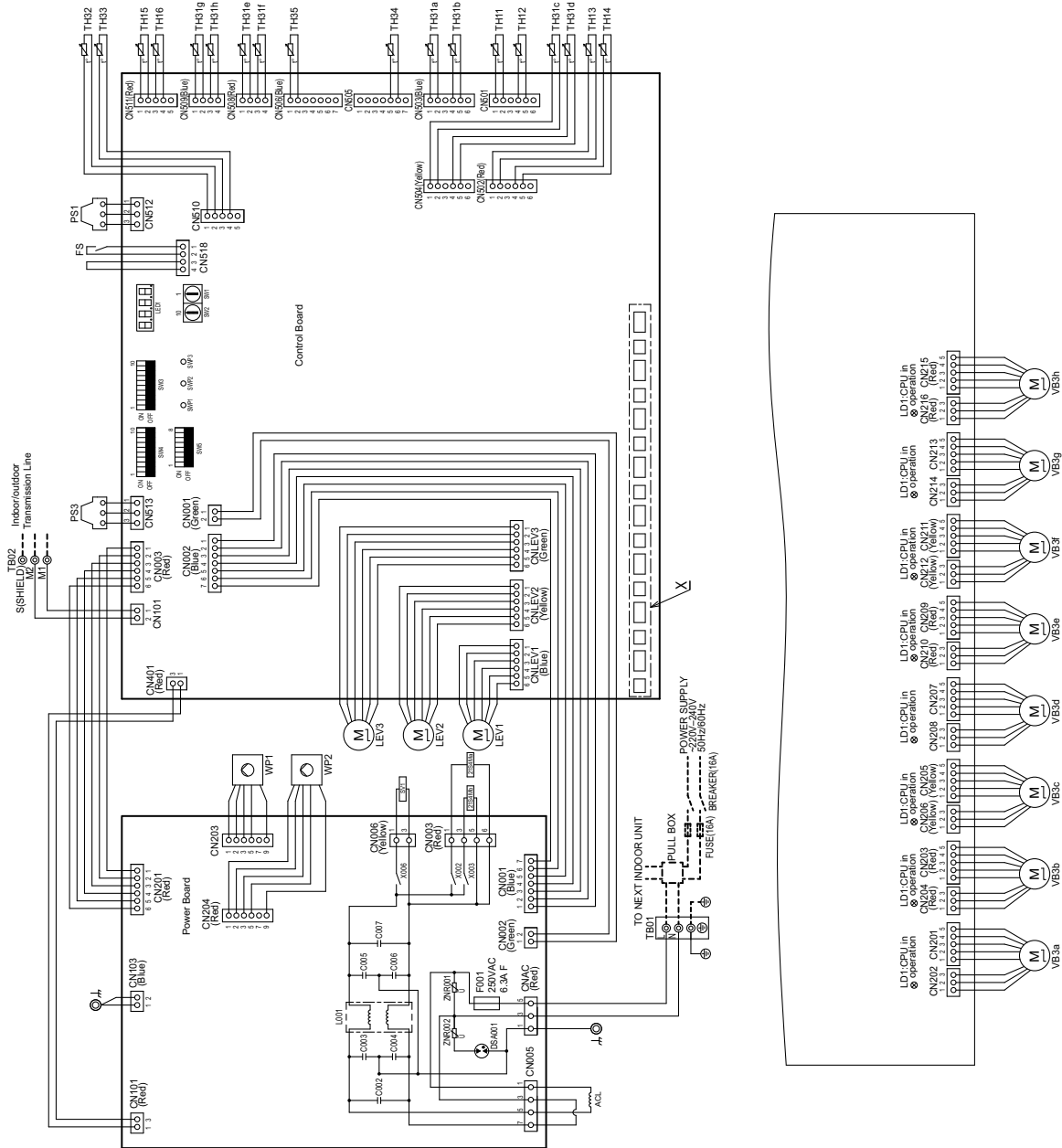

Detail of X section.

HBC

4. ELECTRICAL WIRING DIAGRAMS

CMB-WP1016V-GA1

(Symbol explanation)			
Symbol	Name	Symbol	Name
ACL	AC reactor	SV1	Solenoid valve
TH11-16, TH32-35,		F001	Fuse AC250V 6.3A F
TH31a-p	Thermister sensor	WP1, WP2	4 way valve
LEV1-3	Expansion valve	WP2a-p	Pump
PS1, PS3	Pressure sensor	VB2a-p	Valve block
TB01	Terminal block (for power source)	FS	Floater switch
TB02	Terminal block (for Transmission)	Z	Function setting connector

NOTE: 1. TB02 is transmission terminal block.
 Never connect power line to it.
 2. The initial set values of switch on Control Board are as follows.
 SW1:0
 SW2:0

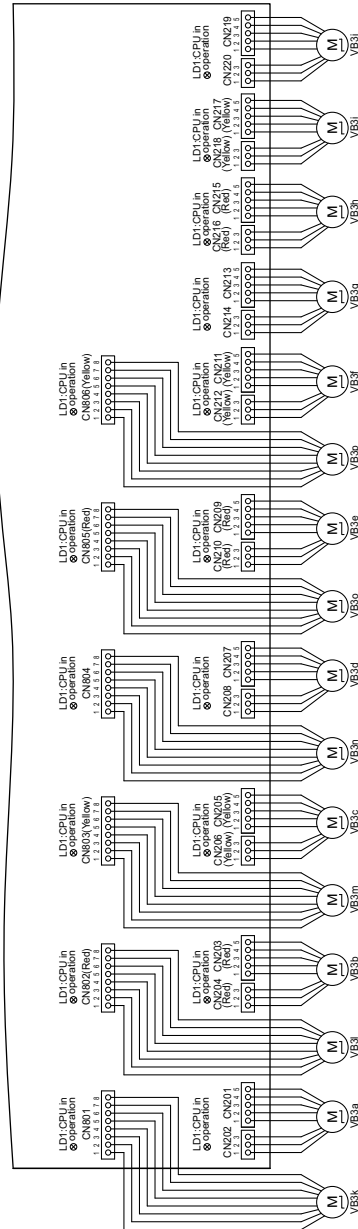
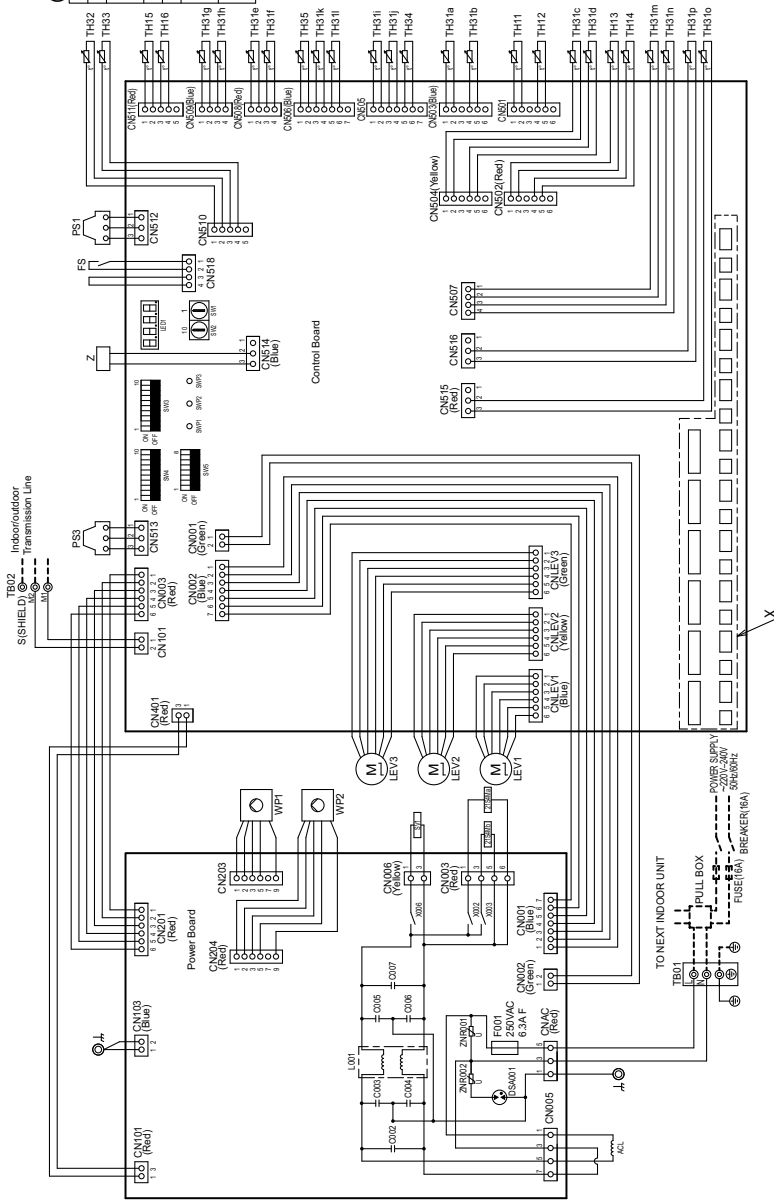

Detail of X section

4. ELECTRICAL WIRING DIAGRAMS

CMB-WP108V-GB1

Symbol	Name
TH31a-h, TH32, TH33	Thermister sensor
VB3a-h	Valve block
FS	Float switch
TB01	Terminal block (for power source)
TB02	Terminal block (for transmission)
F001	Fuse AC250V 6.3A F

NOTE: 1. TB02 is transmission terminal block.
 Never connect power line to it.
 2. The initial set values of switch on Control Board are as follows.
 SW1:0
 SW2:0

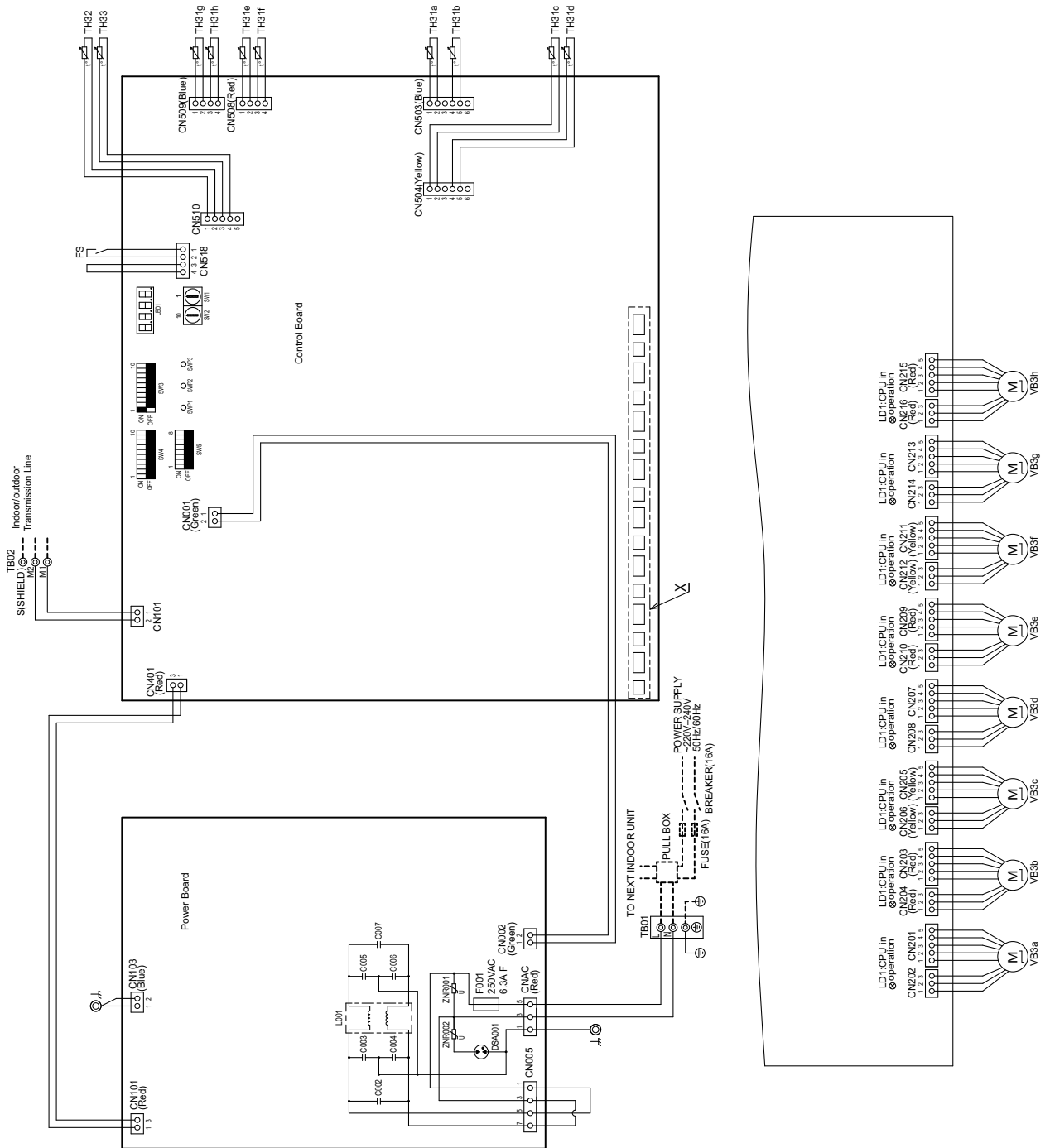

Detail of X section

4. ELECTRICAL WIRING DIAGRAMS

CMB-WP1016V-GB1

HBC

(Symbol explanation)

Symbol	Name
TH31a-p, TH32, TH33	Thermister sensor
VB3a-p	Valve block
FS	Float switch
Z	Function setting connector
TB01	Terminal block (for power source)
TB02	Terminal block (for transmission)
F001	Fuse AC250V 6.3AF

NOTE: 1. TB02 is transmission terminal block.
 Never connect power line to it.
 2. The initial set values of switch on Control Board are as follows.
 SW1: 0
 SW2: 0

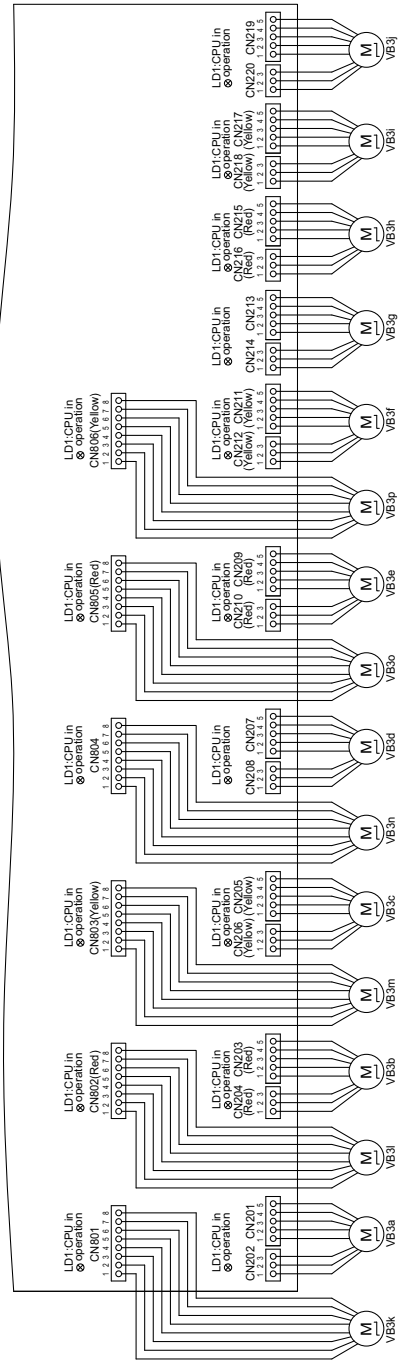
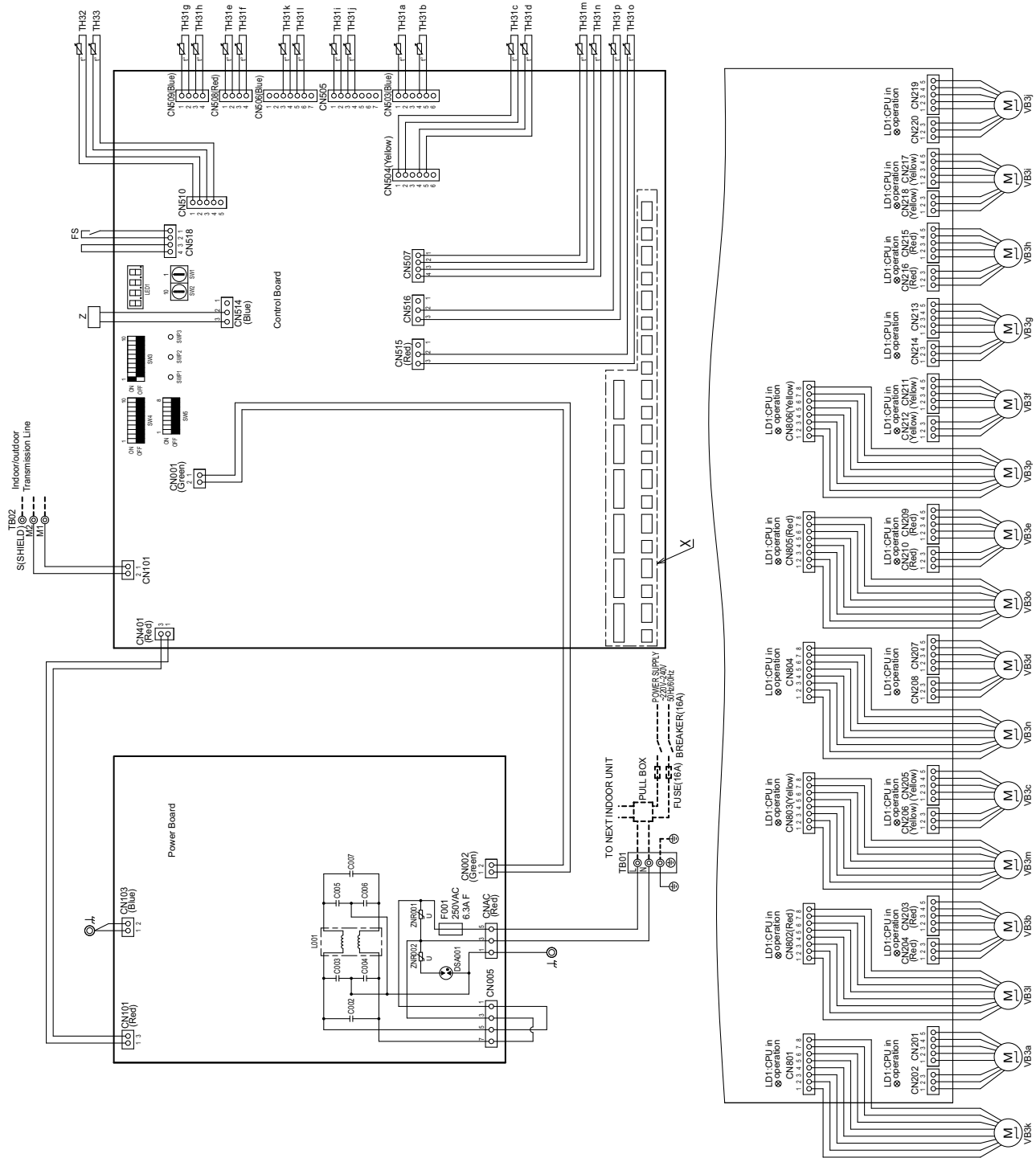

5. SOUND LEVELS

5-1. Sound levels

(Measured point)

CMB-WP108V-GA1
CMB-WP1016V-GA1

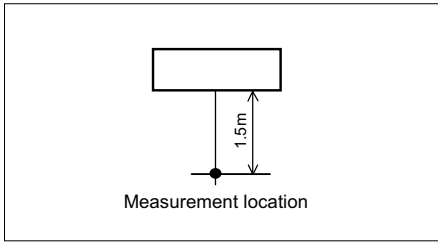

* Measured in anechoic room.

5-2. NC curves

CMB-WP108V-GA1, CMB-WP1016V-GA1

Power Source: 230V, 50Hz

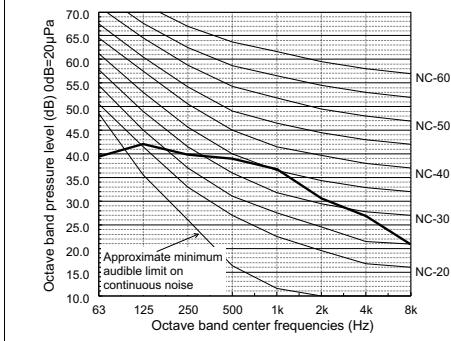

CAPACITY TABLES

Capacity Tables

1. Cooling [Ceiling concealed (Slim type)]	1 - 78
1-1. Cooling capacity with PURY-(E)P200-250YLM-A1	1 - 78
1-2. Cooling capacity with PURY-(E)P300-400YLM-A1	1 - 78
1-3. Cooling capacity with PURY-(E)P450-500YLM-A1	1 - 78
2. Cooling [Ceiling concealed (Middle static pressure type)]	1 - 79
2-1. Cooling capacity with PURY-(E)P200-250YLM-A1	1 - 79
2-2. Cooling capacity with PURY-(E)P300-400YLM-A1	1 - 79
2-3. Cooling capacity with PURY-(E)P450-500YLM-A1	1 - 79
3. Cooling [Ceiling cassette (4-way flow type)]	1 - 80
3-1. Cooling capacity with PURY-(E)P200-250YLM-A1	1 - 80
3-2. Cooling capacity with PURY-(E)P300-400YLM-A1	1 - 80
3-3. Cooling capacity with PURY-(E)P450-500YLM-A1	1 - 80
4. Cooling [Floor standing (Concealed type)]	1 - 81
4-1. Cooling capacity with PURY-(E)P200-250YLM-A1	1 - 81
4-2. Cooling capacity with PURY-(E)P300-400YLM-A1	1 - 81
4-3. Cooling capacity with PURY-(E)P450-500YLM-A1	1 - 81
5. Heating [All indoor units]	1 - 82
5-1. Heating capacity with PURY-(E)P200-250YLM-A1	1 - 82
5-2. Heating capacity with PURY-(E)P300-400YLM-A1	1 - 82
5-3. Heating capacity with PURY-(E)P450-500YLM-A1	1 - 82
5-4. Heating capacity with PURY-(E)P200-250YLM-A1 "COP priority mode"	1 - 83
5-5. Heating capacity with PURY-(E)P300-400YLM-A1 "COP priority mode"	1 - 83
5-6. Heating capacity with PURY-(E)P450-500YLM-A1 "COP priority mode"	1 - 83

1. Cooling [Ceiling concealed (Slim type)]

1-1. Cooling capacity with PURY-(E)P200-250YLM-A1

PEFY-WP-VMS1-E

CA: Capacity (kW), SHC: Sensible Heat Capacity (kW)

Model size (Rated kW)	Indoor air temp.													
	21.5°C D.B. 15°C W.B.		23°C D.B. 16°C W.B.		25°C D.B. 18°C W.B.		27°C D.B. 19°C W.B.		28°C D.B. 20°C W.B.		30°C D.B. 22°C W.B.		32°C D.B. 24°C W.B.	
	CA	SHC	CA	SHC	CA	SHC	CA	SHC	CA	SHC	CA	SHC	CA	SHC
15 (1.7)	1.5	1.5	1.6	1.5	1.7	1.5	1.7	1.6	1.7	1.6	1.8	1.6	1.9	1.6
20 (2.2)	2.0	1.7	2.0	1.8	2.1	1.8	2.2	1.9	2.3	1.9	2.4	1.9	2.5	1.8
25 (2.8)	2.5	2.0	2.6	2.1	2.7	2.1	2.8	2.2	2.9	2.2	3.0	2.1	3.2	2.1
32 (3.6)	3.2	2.7	3.3	2.7	3.5	2.7	3.6	2.9	3.7	2.9	3.9	2.8	4.1	2.8
40 (4.5)	4.0	3.2	4.1	3.3	4.4	3.3	4.5	3.5	4.6	3.5	4.9	3.4	5.2	3.4
50 (5.6)	5.0	4.0	5.2	4.2	5.5	4.1	5.6	4.4	5.8	4.4	6.0	4.3	6.4	4.2

* The capacity does not depend on the outdoor temperature.

kcal/h = kW x 860, BTU/h = kW x 3,412

1-2. Cooling capacity with PURY-(E)P300-400YLM-A1

PEFY-WP-VMS1-E

CA: Capacity (kW), SHC: Sensible Heat Capacity (kW)

Model size (Rated kW)	Indoor air temp.													
	21.5°C D.B. 15°C W.B.		23°C D.B. 16°C W.B.		25°C D.B. 18°C W.B.		27°C D.B. 19°C W.B.		28°C D.B. 20°C W.B.		30°C D.B. 22°C W.B.		32°C D.B. 24°C W.B.	
	CA	SHC	CA	SHC	CA	SHC	CA	SHC	CA	SHC	CA	SHC	CA	SHC
15 (1.7)	1.5	1.5	1.5	1.5	1.6	1.5	1.7	1.6	1.7	1.6	1.9	1.6	2.0	1.6
20 (2.2)	2.0	1.7	2.0	1.8	2.1	1.8	2.2	1.9	2.3	1.9	2.4	1.9	2.5	1.8
25 (2.8)	2.5	2.0	2.5	2.1	2.7	2.0	2.8	2.2	2.9	2.2	3.0	2.1	3.2	2.1
32 (3.6)	3.2	2.6	3.3	2.7	3.5	2.7	3.6	2.9	3.7	2.9	3.9	2.8	4.2	2.8
40 (4.5)	4.0	3.2	4.1	3.3	4.3	3.3	4.5	3.5	4.6	3.5	4.9	3.4	5.2	3.4
50 (5.6)	5.0	4.0	5.1	4.1	5.4	4.1	5.6	4.4	5.7	4.4	6.1	4.3	6.5	4.2

* The capacity does not depend on the outdoor temperature.

kcal/h = kW x 860, BTU/h = kW x 3,412

1-3. Cooling capacity with PURY-(E)P450-500YLM-A1

PEFY-WP-VMS1-E

CA: Capacity (kW), SHC: Sensible Heat Capacity (kW)

Model size (Rated kW)	Indoor air temp.													
	21.5°C D.B. 15°C W.B.		23°C D.B. 16°C W.B.		25°C D.B. 18°C W.B.		27°C D.B. 19°C W.B.		28°C D.B. 20°C W.B.		30°C D.B. 22°C W.B.		32°C D.B. 24°C W.B.	
	CA	SHC	CA	SHC	CA	SHC	CA	SHC	CA	SHC	CA	SHC	CA	SHC
15 (1.7)	1.5	1.5	1.5	1.5	1.7	1.5	1.7	1.6	1.8	1.6	1.9	1.6	2.0	1.6
20 (2.2)	2.0	1.7	2.0	1.8	2.1	1.8	2.2	1.9	2.3	1.9	2.5	1.9	2.6	1.9
25 (2.8)	2.5	2.0	2.5	2.1	2.7	2.0	2.8	2.2	2.9	2.2	3.1	2.2	3.3	2.1
32 (3.6)	3.2	2.6	3.3	2.7	3.5	2.7	3.6	2.9	3.8	2.9	4.0	2.9	4.3	2.8
40 (4.5)	4.0	3.2	4.1	3.3	4.4	3.3	4.5	3.5	4.7	3.5	5.0	3.5	5.4	3.4
50 (5.6)	5.0	4.0	5.1	4.1	5.4	4.1	5.6	4.4	5.8	4.4	6.2	4.4	6.7	4.3

* The capacity does not depend on the outdoor temperature.

kcal/h = kW x 860, BTU/h = kW x 3,412

CT

2. Cooling [Ceiling concealed (Middle static pressure type)]

2-1. Cooling capacity with PURY-(E)P200-250YLM-A1

PEFY-WP-VMA-E

CA: Capacity (kW), SHC: Sensible Heat Capacity (kW)

Model size (Rated kW)	Indoor air temp.													
	21.5°C D.B. 15°C W.B.		23°C D.B. 16°C W.B.		25°C D.B. 18°C W.B.		27°C D.B. 19°C W.B.		28°C D.B. 20°C W.B.		30°C D.B. 22°C W.B.		32°C D.B. 24°C W.B.	
	CA	SHC	CA	SHC	CA	SHC	CA	SHC	CA	SHC	CA	SHC	CA	SHC
20 (2.2)	2.0	1.8	2.0	1.9	2.1	1.8	2.2	2.0	2.3	2.0	2.4	1.9	2.5	1.9
25 (2.8)	2.5	2.5	2.6	2.6	2.7	2.6	2.8	2.8	2.9	2.7	3.0	2.7	3.2	2.7
32 (3.6)	3.2	3.0	3.3	3.1	3.5	3.1	3.6	3.3	3.7	3.3	3.9	3.3	4.1	3.2
40 (4.5)	4.0	3.8	4.1	3.9	4.4	3.9	4.5	4.2	4.6	4.1	4.9	4.1	5.2	4.0
50 (5.6)	5.0	4.2	5.2	4.3	5.5	4.3	5.6	4.6	5.8	4.6	6.0	4.5	6.4	4.4

* The capacity does not depend on the outdoor temperature.

kcal/h = kW x 860, BTU/h = kW x 3,412

2-2. Cooling capacity with PURY-(E)P300-400YLM-A1

PEFY-WP-VMA-E

CA: Capacity (kW), SHC: Sensible Heat Capacity (kW)

Model size (Rated kW)	Indoor air temp.													
	21.5°C D.B. 15°C W.B.		23°C D.B. 16°C W.B.		25°C D.B. 18°C W.B.		27°C D.B. 19°C W.B.		28°C D.B. 20°C W.B.		30°C D.B. 22°C W.B.		32°C D.B. 24°C W.B.	
	CA	SHC	CA	SHC	CA	SHC	CA	SHC	CA	SHC	CA	SHC	CA	SHC
20 (2.2)	2.0	1.8	2.0	1.8	2.1	1.8	2.2	2.0	2.3	2.0	2.4	1.9	2.5	1.9
25 (2.8)	2.5	2.5	2.5	2.5	2.7	2.5	2.8	2.8	2.9	2.7	3.0	2.7	3.2	2.7
32 (3.6)	3.2	3.0	3.3	3.1	3.5	3.1	3.6	3.3	3.7	3.3	3.9	3.3	4.2	3.2
40 (4.5)	4.0	3.7	4.1	3.9	4.3	3.8	4.5	4.2	4.6	4.1	4.9	4.1	5.2	4.0
50 (5.6)	5.0	4.2	5.1	4.3	5.4	4.3	5.6	4.6	5.7	4.5	6.1	4.5	6.5	4.4

* The capacity does not depend on the outdoor temperature.

kcal/h = kW x 860, BTU/h = kW x 3,412

2-3. Cooling capacity with PURY-(E)P450-500YLM-A1

PEFY-WP-VMA-E

CA: Capacity (kW), SHC: Sensible Heat Capacity (kW)

Model size (Rated kW)	Indoor air temp.													
	21.5°C D.B. 15°C W.B.		23°C D.B. 16°C W.B.		25°C D.B. 18°C W.B.		27°C D.B. 19°C W.B.		28°C D.B. 20°C W.B.		30°C D.B. 22°C W.B.		32°C D.B. 24°C W.B.	
	CA	SHC	CA	SHC	CA	SHC	CA	SHC	CA	SHC	CA	SHC	CA	SHC
20 (2.2)	2.0	1.8	2.0	1.8	2.1	1.8	2.2	2.0	2.3	2.0	2.5	2.0	2.6	1.9
25 (2.8)	2.5	2.5	2.5	2.5	2.7	2.6	2.8	2.8	2.9	2.8	3.1	2.7	3.3	2.7
32 (3.6)	3.2	3.0	3.3	3.1	3.5	3.1	3.6	3.3	3.8	3.3	4.0	3.3	4.3	3.3
40 (4.5)	4.0	3.7	4.1	3.9	4.4	3.9	4.5	4.2	4.7	4.2	5.0	4.1	5.4	4.1
50 (5.6)	5.0	4.2	5.1	4.3	5.4	4.3	5.6	4.6	5.8	4.6	6.2	4.5	6.7	4.5

* The capacity does not depend on the outdoor temperature.

kcal/h = kW x 860, BTU/h = kW x 3,412

CT

3. Cooling [Ceiling cassette (4-way flow type)]

3-1. Cooling capacity with PURY-(E)P200-250YLM-A1

PLFY-WP-VBM-E

CA: Capacity (kW), SHC: Sensible Heat Capacity (kW)

Model size (Rated kW)	Indoor air temp.													
	21.5°C D.B. 15°C W.B.		23°C D.B. 16°C W.B.		25°C D.B. 18°C W.B.		27°C D.B. 19°C W.B.		28°C D.B. 20°C W.B.		30°C D.B. 22°C W.B.		32°C D.B. 24°C W.B.	
	CA	SHC	CA	SHC	CA	SHC	CA	SHC	CA	SHC	CA	SHC	CA	SHC
32 (3.6)	3.2	3.2	3.3	3.3	3.5	3.3	3.6	3.5	3.7	3.5	3.9	3.5	4.1	3.4
40 (4.5)	4.0	3.6	4.1	3.7	4.4	3.6	4.5	3.9	4.6	3.9	4.9	3.8	5.2	3.8
50 (5.6)	5.0	4.2	5.2	4.4	5.5	4.3	5.6	4.6	5.8	4.6	6.0	4.5	6.4	4.4

* The capacity does not depend on the outdoor temperature.

kcal/h = kW x 860, BTU/h = kW x 3,412

3-2. Cooling capacity with PURY-(E)P300-400YLM-A1

PLFY-WP-VBM-E

CA: Capacity (kW), SHC: Sensible Heat Capacity (kW)

Model size (Rated kW)	Indoor air temp.													
	21.5°C D.B. 15°C W.B.		23°C D.B. 16°C W.B.		25°C D.B. 18°C W.B.		27°C D.B. 19°C W.B.		28°C D.B. 20°C W.B.		30°C D.B. 22°C W.B.		32°C D.B. 24°C W.B.	
	CA	SHC	CA	SHC	CA	SHC	CA	SHC	CA	SHC	CA	SHC	CA	SHC
32 (3.6)	3.2	3.2	3.3	3.3	3.5	3.3	3.6	3.5	3.7	3.5	3.9	3.5	4.2	3.4
40 (4.5)	4.0	3.5	4.1	3.7	4.3	3.6	4.5	3.9	4.6	3.9	4.9	3.8	5.2	3.8
50 (5.6)	5.0	4.2	5.1	4.3	5.4	4.3	5.6	4.6	5.7	4.6	6.1	4.5	6.5	4.4

* The capacity does not depend on the outdoor temperature.

kcal/h = kW x 860, BTU/h = kW x 3,412

3-3. Cooling capacity with PURY-(E)P450-500YLM-A1

PLFY-WP-VBM-E

CA: Capacity (kW), SHC: Sensible Heat Capacity (kW)

Model size (Rated kW)	Indoor air temp.													
	21.5°C D.B. 15°C W.B.		23°C D.B. 16°C W.B.		25°C D.B. 18°C W.B.		27°C D.B. 19°C W.B.		28°C D.B. 20°C W.B.		30°C D.B. 22°C W.B.		32°C D.B. 24°C W.B.	
	CA	SHC	CA	SHC	CA	SHC	CA	SHC	CA	SHC	CA	SHC	CA	SHC
32 (3.6)	3.2	3.2	3.3	3.3	3.5	3.3	3.6	3.5	3.8	3.5	4.0	3.5	4.3	3.5
40 (4.5)	4.0	3.5	4.1	3.7	4.4	3.6	4.5	3.9	4.7	3.9	5.0	3.9	5.4	3.8
50 (5.6)	5.0	4.2	5.1	4.3	5.4	4.3	5.6	4.6	5.8	4.6	6.2	4.6	6.7	4.5

* The capacity does not depend on the outdoor temperature.

kcal/h = kW x 860, BTU/h = kW x 3,412

4. Cooling [Floor standing (Concealed type)]

4-1. Cooling capacity with PURY-(E)P200-250YLM-A1

PFFY-WP-VLRMM-E

CA: Capacity (kW), SHC: Sensible Heat Capacity (kW)

Model size (Rated kW)	Indoor air temp.													
	21.5°C D.B. 15°C W.B.		23°C D.B. 16°C W.B.		25°C D.B. 18°C W.B.		27°C D.B. 19°C W.B.		28°C D.B. 20°C W.B.		30°C D.B. 22°C W.B.		32°C D.B. 24°C W.B.	
	CA	SHC	CA	SHC	CA	SHC	CA	SHC	CA	SHC	CA	SHC	CA	SHC
20 (2.2)	2.0	1.5	2.0	1.6	2.1	1.6	2.2	1.7	2.3	1.7	2.4	1.6	2.5	1.6
25 (2.8)	2.5	2.0	2.6	2.1	2.7	2.1	2.8	2.2	2.9	2.2	3.0	2.2	3.2	2.1
32 (3.6)	3.2	2.5	3.3	2.6	3.5	2.6	3.6	2.7	3.7	2.7	3.9	2.7	4.1	2.6
40 (4.5)	4.0	3.1	4.1	3.2	4.4	3.2	4.5	3.4	4.6	3.4	4.9	3.3	5.2	3.2
50 (5.6)	5.0	3.9	5.2	4.0	5.5	4.0	5.6	4.2	5.8	4.2	6.0	4.1	6.4	4.0

* The capacity does not depend on the outdoor temperature.

kcal/h = kW x 860, BTU/h = kW x 3,412

4-2. Cooling capacity with PURY-(E)P300-400YLM-A1

PFFY-WP-VLRMM-E

CA: Capacity (kW), SHC: Sensible Heat Capacity (kW)

Model size (Rated kW)	Indoor air temp.													
	21.5°C D.B. 15°C W.B.		23°C D.B. 16°C W.B.		25°C D.B. 18°C W.B.		27°C D.B. 19°C W.B.		28°C D.B. 20°C W.B.		30°C D.B. 22°C W.B.		32°C D.B. 24°C W.B.	
	CA	SHC	CA	SHC	CA	SHC	CA	SHC	CA	SHC	CA	SHC	CA	SHC
20 (2.2)	2.0	1.5	2.0	1.6	2.1	1.6	2.2	1.7	2.3	1.6	2.4	1.6	2.5	1.6
25 (2.8)	2.5	2.0	2.5	2.1	2.7	2.1	2.8	2.2	2.9	2.2	3.0	2.2	3.2	2.1
32 (3.6)	3.2	2.5	3.3	2.6	3.5	2.6	3.6	2.7	3.7	2.7	3.9	2.7	4.2	2.6
40 (4.5)	4.0	3.1	4.1	3.2	4.3	3.2	4.5	3.4	4.6	3.3	4.9	3.3	5.2	3.3
50 (5.6)	5.0	3.9	5.1	4.0	5.4	3.9	5.6	4.2	5.7	4.2	6.1	4.1	6.5	4.1

* The capacity does not depend on the outdoor temperature.

kcal/h = kW x 860, BTU/h = kW x 3,412

4-3. Cooling capacity with PURY-(E)P450-500YLM-A1

PFFY-WP-VLRMM-E

CA: Capacity (kW), SHC: Sensible Heat Capacity (kW)

Model size (Rated kW)	Indoor air temp.													
	21.5°C D.B. 15°C W.B.		23°C D.B. 16°C W.B.		25°C D.B. 18°C W.B.		27°C D.B. 19°C W.B.		28°C D.B. 20°C W.B.		30°C D.B. 22°C W.B.		32°C D.B. 24°C W.B.	
	CA	SHC	CA	SHC	CA	SHC	CA	SHC	CA	SHC	CA	SHC	CA	SHC
20 (2.2)	2.0	1.5	2.0	1.6	2.1	1.6	2.2	1.7	2.3	1.7	2.5	1.7	2.6	1.6
25 (2.8)	2.5	2.0	2.5	2.1	2.7	2.1	2.8	2.2	2.9	2.2	3.1	2.2	3.3	2.2
32 (3.6)	3.2	2.5	3.3	2.6	3.5	2.6	3.6	2.7	3.8	2.7	4.0	2.7	4.3	2.7
40 (4.5)	4.0	3.1	4.1	3.2	4.4	3.2	4.5	3.4	4.7	3.4	5.0	3.3	5.4	3.3
50 (5.6)	5.0	3.9	5.1	4.0	5.4	4.0	5.6	4.2	5.8	4.2	6.2	4.2	6.7	4.1

* The capacity does not depend on the outdoor temperature.

kcal/h = kW x 860, BTU/h = kW x 3,412

CT

5. Heating [All indoor units]

5-1. Heating capacity with PURY-(E)P200-250YLM-A1

All Indoor units

SHC: Sensible Heat Capacity (kW)

Model size (Rated kW)	Indoor air temp.			
	15°C D.B.	20°C D.B.	25°C D.B.	27°C D.B.
	SHC	SHC	SHC	SHC
15 (1.9)	1.9	1.9	1.5	1.3
20 (2.5)	2.5	2.5	2.0	1.8
25 (3.2)	3.2	3.2	2.6	2.2
32 (4.0)	4.0	4.0	3.2	2.8
40 (5.0)	5.1	5.0	4.0	3.5
50 (6.3)	6.4	6.3	5.0	4.4

* The capacity does not depend on the outdoor temperature.

kcal/h = kW x 860, BTU/h = kW x 3,412

5-2. Heating capacity with PURY-(E)P300-400YLM-A1

All Indoor units

SHC: Sensible Heat Capacity (kW)

Model size (Rated kW)	Indoor air temp.			
	15°C D.B.	20°C D.B.	25°C D.B.	27°C D.B.
	SHC	SHC	SHC	SHC
15 (1.9)	1.9	1.9	1.4	1.2
20 (2.5)	2.6	2.5	1.9	1.6
25 (3.2)	3.3	3.2	2.4	2.0
32 (4.0)	4.1	4.0	3.0	2.6
40 (5.0)	5.1	5.0	3.7	3.2
50 (6.3)	6.5	6.3	4.7	4.0

* The capacity does not depend on the outdoor temperature.

kcal/h = kW x 860, BTU/h = kW x 3,412

5-3. Heating capacity with PURY-(E)P450-500YLM-A1

All Indoor units

SHC: Sensible Heat Capacity (kW)

Model size (Rated kW)	Indoor air temp.			
	15°C D.B.	20°C D.B.	25°C D.B.	27°C D.B.
	SHC	SHC	SHC	SHC
15 (1.9)	1.9	1.9	1.5	1.3
20 (2.5)	2.5	2.5	2.0	1.8
25 (3.2)	3.3	3.2	2.5	2.3
32 (4.0)	4.1	4.0	3.2	2.8
40 (5.0)	5.1	5.0	4.0	3.5
50 (6.3)	6.4	6.3	5.0	4.5

* The capacity does not depend on the outdoor temperature.

kcal/h = kW x 860, BTU/h = kW x 3,412

5. Heating [All indoor units]

5-4. Heating capacity with PURY-(E)P200-250YLM-A1 "COP priority mode"

All Indoor units

SHC: Sensible Heat Capacity (kW)

Model size (Rated kW)	Indoor air temp.			
	15°C D.B.	20°C D.B.	25°C D.B.	27°C D.B.
	SHC	SHC	SHC	SHC
15 (1.9)	1.9	1.9	1.5	1.3
20 (2.5)	2.5	2.5	2.0	1.8
25 (3.2)	3.3	3.2	2.6	2.2
32 (4.0)	4.1	4.0	3.2	2.8
40 (5.0)	5.1	5.0	4.0	3.5
50 (6.3)	6.4	6.3	5.0	4.4

* The capacity does not depend on the outdoor temperature.

kcal/h = kW x 860, BTU/h = kW x 3,412

5-5. Heating capacity with PURY-(E)P300-400YLM-A1 "COP priority mode"

All Indoor units

SHC: Sensible Heat Capacity (kW)

Model size (Rated kW)	Indoor air temp.			
	15°C D.B.	20°C D.B.	25°C D.B.	27°C D.B.
	SHC	SHC	SHC	SHC
15 (1.9)	1.9	1.9	1.4	1.2
20 (2.5)	2.6	2.5	1.9	1.6
25 (3.2)	3.3	3.2	2.4	2.0
32 (4.0)	4.1	4.0	3.0	2.6
40 (5.0)	5.1	5.0	3.7	3.2
50 (6.3)	6.5	6.3	4.7	4.0

* The capacity does not depend on the outdoor temperature.

kcal/h = kW x 860, BTU/h = kW x 3,412

5-6. Heating capacity with PURY-(E)P450-500YLM-A1 "COP priority mode"

All Indoor units

SHC: Sensible Heat Capacity (kW)

Model size (Rated kW)	Indoor air temp.			
	15°C D.B.	20°C D.B.	25°C D.B.	27°C D.B.
	SHC	SHC	SHC	SHC
15 (1.9)	2.0	1.9	1.5	1.3
20 (2.5)	2.6	2.5	2.0	1.8
25 (3.2)	3.3	3.2	2.5	2.3
32 (4.0)	4.1	4.0	3.2	2.8
40 (5.0)	5.1	5.0	4.0	3.5
50 (6.3)	6.5	6.3	5.0	4.5

* The capacity does not depend on the outdoor temperature.

kcal/h = kW x 860, BTU/h = kW x 3,412

HYBRID CITY MULTI

2. OUTDOOR UNITS

YLM SERIES 2 - 3

OUTDOOR UNITS

1. SPECIFICATIONS	2 - 4
2. CAPACITY TABLES	2 - 14
2-1. Correction by temperature	2 - 14
2-2. Correction by total indoor	2 - 26
2-3. Correction by piping length	2 - 30
2-4. Correction at frost and defrost	2 - 33
2-5. Correction by antifreeze solution concentration	2 - 34
2-6. Operation temperature range	2 - 35

1. SPECIFICATIONS

OUTDOOR

Model			PURY-P200YLM-A1 (-BS)	PURY-P250YLM-A1 (-BS)	
Power source			3-phase 4-wire 380-400-415 V 50/60 Hz	3-phase 4-wire 380-400-415 V 50/60 Hz	
Cooling capacity (Nominal)	*1	kW	22.4	28.0	
		kcal/h	20,000	25,000	
		BTU/h	76,400	95,500	
	*1	Power input	kW	7.00	9.92
		Current input	A	11.8-11.2-10.8	16.7-15.9-15.3
		EER	kW/kW	3.20	2.82
Temp. range of cooling	*3	Indoor	W.B.	15.0~24.0°C (59~75°F)	
		Outdoor	D.B.	-5.0~46.0°C (23~115°F)	
Heating capacity (Nominal)	*2	kW	25.0	31.5	
		kcal/h	21,500	27,100	
		BTU/h	85,300	107,500	
	*2	Power input	kW	7.08	10.06
		Current input	A	11.9-11.3-10.9	16.9-16.1-15.5
		COP	kW/kW	3.53	3.13
Temp. range of heating	*3	Indoor	D.B.	15.0~27.0°C (59~81°F)	
		Outdoor	W.B.	-20.0~15.5°C (-4~60°F)	
Indoor unit connectable	Total capacity		50~150% of outdoor unit capacity	50~150% of outdoor unit capacity	
	Model/Quantity		WP15-WP50/2-20	WP15-WP50/3-25	
Sound pressure level (measured in anechoic room)		dB <A>	59	60	
Sound power level (measured in anechoic room)		dB <A>	82.5	83.5	
Refrigerant piping diameter	High pressure	mm (in.)	15.88 (5/8) Brazed	19.05 (3/4) Brazed	
	Low pressure	mm (in.)	19.05 (3/4) Brazed	22.2 (7/8) Brazed	
FAN	Type x Quantity		Propeller fan x 1	Propeller fan x 1	
	Air flow rate	m ³ /min	185	185	
		L/s	3,083	3,083	
		cfm	6,532	6,532	
	Control, Driving mechanism		Inverter-control, Direct-driven by motor	Inverter-control, Direct-driven by motor	
	Motor output	kW	0.92 x 1	0.92 x 1	
*4 External static press.		0 Pa (0 mmH ₂ O)	0 Pa (0 mmH ₂ O)		
Compressor	Type		Inverter scroll hermetic compressor	Inverter scroll hermetic compressor	
	Manufacture		AC&R Works, MITSUBISHI ELECTRIC CORPORATION	AC&R Works, MITSUBISHI ELECTRIC CORPORATION	
	Starting method		Inverter	Inverter	
	Motor output	kW	5.6	6.9	
	Case heater	kW	-	-	
Lubricant		MEL32	MEL32		
External finish		Pre-coated galvanized steel sheets (+powder coating for -BS type) <MUNSELL 5Y 8/1 or similar>	Pre-coated galvanized steel sheets (+powder coating for -BS type) <MUNSELL 5Y 8/1 or similar>		
External dimension H x W x D		mm 1,710 (1,650 without legs) x 920 x 740 in. 67-3/8 (65 without legs) x 36-1/4 x 29-3/16	mm 1,710 (1,650 without legs) x 920 x 740 in. 67-3/8 (65 without legs) x 36-1/4 x 29-3/16		
Protection devices	High pressure protection		High pressure sensor, High pressure switch at 4.15 MPa (601 psi)	High pressure sensor, High pressure switch at 4.15 MPa (601 psi)	
	Inverter circuit (COMP./FAN)		Over-heat protection, Over-current protection	Over-heat protection, Over-current protection	
	Compressor		-	-	
	Fan motor		-	-	
Refrigerant	Type x original charge		R410A x 9.5 kg (21 lbs)	R410A x 9.5 kg (21 lbs)	
	Control		HBC controller	HBC controller	
Net weight		kg (lbs)	205 (452)	205 (452)	
Heat exchanger		Salt-resistant cross fin & copper tube			
HIC circuit (HIC: Heat Inter-Changer)		-			
Defrosting method		Auto-defrost mode (Reversed refrigerant cycle, Hot gas)			
Drawing	External	WKJ94T176			
	Wiring	WKE94G041			
Standard attachment	Document	Installation Manual			
	Accessory	Refrigerant conn. pipe			
Optional parts		Main HBC controller: CMB-WP108,1016V-GA1 Sub HBC controller: CMB-WP108,1016V-GB1			
Remarks		Details on foundation work, duct work, insulation work, electrical wiring, power source switch, and other items shall be referred to the Installation Manual. Due to continuing improvement, above specifications may be subject to change without notice.			

Notes:	Unit converter
1. Nominal cooling conditions (subject to JIS B8615-2) Indoor: 27°C D.B./19°C W.B. (81°F D.B./66°F W.B.), Outdoor: 35°C D.B./24°C W.B. (95°F D.B./75°F W.B.) Pipe length: 7.5 m (24-9/16 ft.), Level difference: 0 m (0 ft.)	BTU/h = kW x 3,412
2. Nominal heating conditions (subject to JIS B8615-2) Indoor: 20°C D.B. (68°F D.B.), Outdoor: 7°C D.B./6°C W.B. (45°F D.B./43°F W.B.) Pipe length: 7.5 m (24-9/16 ft.), Level difference: 0 m (0 ft.)	cfm = m ³ /min x 35.31
3. 5°C D.B. (23°F D.B.)/-6°C W.B. (21°F W.B.) to 21°C D.B. (70°F D.B.)/15.5°C W.B. (60°F W.B.) with cooling/heating mixed operation.	lbs = kg/0.4536
4. External static pressure option is available (30 Pa, 60 Pa/3.1 mmH ₂ O, 6.1 mmH ₂ O).	*Above specification data is subject to rounding variation.

1. SPECIFICATIONS

Model		PURY-P300YLM-A1 (-BS)	
Number of HBC controller		Single HBC	Double HBC
Power source		3-phase 4-wire 380-400-415 V 50/60 Hz	
Cooling capacity (Nominal)	*1 kW	33.5	
	kcal/h	28,800	
	*1 BTU/h	114,300	
	Power input	13.34	11.31
	Current input	22.5-21.3-20.6	19.0-18.1-17.4
EER	kW/kW	2.51	2.96
Temp. range of cooling	*3 Indoor	W.B.	15.0~24.0°C (59~75°F)
	Outdoor	D.B.	-5.0~46.0°C (23~115°F)
Heating capacity (Nominal)	*2 kW	37.5	
	kcal/h	32,300	
	*2 BTU/h	128,000	
	Power input	12.71	11.94
	Current input	21.4-20.3-19.6	20.1-19.1-18.4
COP	kW/kW	2.95	3.14
Temp. range of heating	*3 Indoor	D.B.	15.0~27.0°C (59~81°F)
	Outdoor	W.B.	-20.0~15.5°C (-4~60°F)
Indoor unit connectable	Total capacity	50~150% of outdoor unit capacity	
	Model/Quantity	WP15-WP50/3~30	
Sound pressure level (measured in anechoic room)	dB <A>	62.5	
Sound power level (measured in anechoic room)	dB <A>	86	
Refrigerant piping diameter	High pressure	mm (in.)	19.05 (3/4) Brazed
	Low pressure	mm (in.)	22.2 (7/8) Brazed
FAN	Type x Quantity	Propeller fan x 1	
	Air flow rate	m ³ /min	230
		L/s	3,833
		cfm	8,121
	Control, Driving mechanism	Inverter-control, Direct-driven by motor	
*4 Motor output	kW	0.92 x 1	
External static press.		0 Pa (0 mmH ₂ O)	
Compressor	Type	Inverter scroll hermetic compressor	
	Manufacture	AC&R Works, MITSUBISHI ELECTRIC CORPORATION	
	Starting method	Inverter	
	Motor output	kW	8.1
	Case heater	kW	-
	Lubricant	MEL32	
External finish	Pre-coated galvanized steel sheets (+powder coating for -BS type) <MUNSELL 5Y 8/1 or similar>		
External dimension H x W x D	mm	1,710 (1,650 without legs) x 1,220 x 740	
	in.	67-3/8 (65 without legs) x 48-1/16 x 29-3/16	
Protection devices	High pressure protection	High pressure sensor, High pressure switch at 4.15 MPa (601 psi)	
	Inverter circuit (COMP./FAN)	Over-heat protection, Over-current protection	
	Compressor	-	
	Fan motor	-	
Refrigerant	Type x original charge	R410A x 10.3 kg (23 lbs)	
	Control	HBC controller	
Net weight	kg (lbs)	248 (547)	
Heat exchanger	Salt-resistant cross fin & copper tube		
HIC circuit (HIC: Heat Inter-Changer)	-		
Defrosting method	Auto-defrost mode (Reversed refrigerant cycle, Hot gas)		
Drawing	External	WKJ94T177	
	Wiring	WKE94G041	
Standard attachment	Document	Installation Manual	
	Accessory	Refrigerant conn. pipe	
Optional parts	Main HBC controller: CMB-WP108, 1016V-GA1 Sub HBC controller: CMB-WP108, 1016V-GB1		
Remarks	Details on foundation work, duct work, insulation work, electrical wiring, power source switch, and other items shall be referred to the Installation Manual. Due to continuing improvement, above specifications may be subject to change without notice.		

Notes:	Unit converter
1.Nominal cooling conditions (subject to JIS B8615-2) Indoor: 27°C D.B./19°C W.B. (81°F D.B./66°F W.B.), Outdoor: 35°C D.B. (95°F D.B.) Pipe length: 7.5 m (24-9/16 ft.), Level difference: 0 m (0 ft.)	BTU/h =kW x 3,412
2.Nominal heating conditions (subject to JIS B8615-2) Indoor: 20°C D.B. (68°F D.B.), Outdoor: 7°C D.B./6°C W.B. (45°F D.B./43°F W.B.) Pipe length: 7.5 m (24-9/16 ft.), Level difference: 0 m (0 ft.)	cfm =m ³ /min x 35.31
3.-5°C D.B. (23°F D.B.)/-6°C W.B. (21°F W.B.) to 21°C D.B. (70°F D.B.)/15.5°C W.B. (60°F W.B.) with cooling/heating mixed operation.	lbs =kg/0.4536
4.External static pressure option is available (30 Pa, 60 Pa/3.1 mmH ₂ O, 6.1 mmH ₂ O).	*Above specification data is subject to rounding variation.

1. SPECIFICATIONS

OUTDOOR

Model			PURY-P350YLM-A1 (-BS)		
Number of HBC controller			Single HBC	Double HBC	
Power source			3-phase 4-wire 380-400-415 V 50/60 Hz		
Cooling capacity (Nominal)	*1	kW	40.0		
		kcal/h	34,400		
		BTU/h	136,500		
	*1	Power input	kW	17.93	14.59
		Current input	A	30.2-28.7-27.7	24.6-23.3-22.5
EER	kW/kW	2.23	2.74		
Temp. range of cooling	*3	Indoor	W.B.	15.0~24.0°C (59~75°F)	
		Outdoor	D.B.	-5.0~46.0°C (23~115°F)	
Heating capacity (Nominal)	*2	kW	45.0		
		kcal/h	38,700		
		BTU/h	153,500		
	*2	Power input	kW	15.51	14.35
		Current input	A	26.1-24.8-23.9	24.2-23.0-22.1
COP	kW/kW	2.90	3.13		
Temp. range of heating	*3	Indoor	D.B.	15.0~27.0°C (59~81°F)	
		Outdoor	W.B.	-20.0~15.5°C (-4~60°F)	
Indoor unit connectable	Total capacity		50~150% of outdoor unit capacity		
	Model/Quantity		WP15-WP50/4~35		
Sound pressure level (measured in anechoic room)	dB <A>		62.5		
Sound power level (measured in anechoic room)	dB <A>		86		
Refrigerant piping diameter	High pressure	mm (in.)	19.05 (3/4) Brazed		
	Low pressure	mm (in.)	28.58 (1-1/8) Brazed		
FAN	Type x Quantity		Propeller fan x 1		
	Air flow rate	m ³ /min	230		
		L/s	3,833		
		cfm	8,121		
	Control, Driving mechanism		Inverter-control, Direct-driven by motor		
*4	Motor output	kW	0.92 x 1		
External static press.		0 Pa (0 mmH ₂ O)			
Compressor	Type		Inverter scroll hermetic compressor		
	Manufacture		AC&R Works, MITSUBISHI ELECTRIC CORPORATION		
	Starting method		Inverter		
	Motor output	kW	10.5		
	Case heater	kW	-		
	Lubricant		MEL32		
External finish			Pre-coated galvanized steel sheets (+powder coating for -BS type) <MUNSELL 5Y 8/1 or similar>		
External dimension H x W x D	mm		1,710 (1,650 without legs) x 1,220 x 740		
	in.		67-3/8 (65 without legs) x 48-1/16 x 29-3/16		
Protection devices	High pressure protection		High pressure sensor, High pressure switch at 4.15 MPa (601 psi)		
	Inverter circuit (COMP./FAN)		Over-heat protection, Over-current protection		
	Compressor		-		
	Fan motor		-		
Refrigerant	Type x original charge		R410A x 10.3 kg (23 lbs)		
	Control		HBC controller		
Net weight	kg (lbs)		248 (547)		
Heat exchanger			Salt-resistant cross fin & copper tube		
HIC circuit (HIC: Heat Inter-Changer)			-		
Defrosting method			Auto-defrost mode (Reversed refrigerant cycle, Hot gas)		
Drawing	External		WKJ94T177		
	Wiring		WKE94G041		
Standard attachment	Document		Installation Manual		
	Accessory		Refrigerant conn. pipe		
Optional parts			Main HBC controller: CMB-WP108, 1016V-GA1 Sub HBC controller: CMB-WP108, 1016V-GB1		
Remarks			Details on foundation work, duct work, insulation work, electrical wiring, power source switch, and other items shall be referred to the Installation Manual. Due to continuing improvement, above specifications may be subject to change without notice.		

Notes:	Unit converter
1. Nominal cooling conditions (subject to JIS B8615-2) Indoor: 27°C D.B./19°C W.B. (81°F D.B./66°F W.B.), Outdoor: 35°C D.B. (95°F D.B.) Pipe length: 7.5 m (24-9/16 ft.), Level difference: 0 m (0 ft.)	BTU/h = kW x 3,412
2. Nominal heating conditions (subject to JIS B8615-2) Indoor: 20°C D.B. (68°F D.B.), Outdoor: 7°C D.B./6°C W.B. (45°F D.B./43°F W.B.) Pipe length: 7.5 m (24-9/16 ft.), Level difference: 0 m (0 ft.)	cfm = m ³ /min x 35.31
3. -5°C D.B. (23°F D.B.)/-6°C W.B. (21°F W.B.) to 21°C D.B. (70°F D.B.)/15.5°C W.B. (60°F W.B.) with cooling/heating mixed operation.	lbs = kg/0.4536
4. External static pressure option is available (30 Pa, 60 Pa/3.1 mmH ₂ O, 6.1 mmH ₂ O).	*Above specification data is subject to rounding variation.

1. SPECIFICATIONS

Model		PURY-P400YLM-A1 (-BS)		PURY-P450YLM-A1 (-BS)	
Power source		3-phase 4-wire 380-400-415 V 50/60 Hz		3-phase 4-wire 380-400-415 V 50/60 Hz	
Cooling capacity (Nominal)	*1	kW	45.0	50.0	
		kcal/h	40,000	45,000	
		*1 BTU/h	153,500	170,600	
	Power input	kW	16.65	17.92	
		A	28.1-26.7-25.7	30.2-28.7-27.7	
EER	kW/kW	2.70	2.79		
Temp. range of cooling	*3 Indoor	W.B.	15.0~24.0°C (59~75°F)	15.0~24.0°C (59~75°F)	
	Outdoor	D.B.	-5.0~46.0°C (23~115°F)	-5.0~46.0°C (23~115°F)	
Heating capacity (Nominal)	*2	kW	45.0	56.0	
		kcal/h	40,000	50,000	
		*2 BTU/h	153,500	191,100	
	Power input	kW	13.39	17.39	
		A	22.6-21.4-20.6	29.3-27.8-26.8	
COP	kW/kW	3.36	3.22		
Temp. range of heating	*3 Indoor	D.B.	15.0~27.0°C (59~81°F)	15.0~27.0°C (59~81°F)	
	Outdoor	W.B.	-20.0~15.5°C (-4~60°F)	-20.0~15.5°C (-4~60°F)	
Indoor unit connectable	Total capacity		50~150% of outdoor unit capacity	50~150% of outdoor unit capacity	
	Model/Quantity		WP15-WP50/4~40	WP15-WP50/5~45	
Sound pressure level (measured in anechoic room)		dB <A>	62.5	62.5	
Sound power level (measured in anechoic room)		dB <A>	86	86	
Refrigerant piping diameter	High pressure	mm (in.)	22.2 (7/8) Brazed	22.2 (7/8) Brazed	
	Low pressure	mm (in.)	28.58 (1-1/8) Brazed	28.58 (1-1/8) Brazed	
FAN	Type x Quantity		Propeller fan x 1	Propeller fan x 2	
	Air flow rate	m ³ /min	230	320	
		L/s	3,833	5,333	
		cfm	8,121	11,299	
	Control, Driving mechanism		Inverter-control, Direct-driven by motor	Inverter-control, Direct-driven by motor	
*4 Motor output	kW	0.92 x 1	0.92 x 2		
External static press.		0 Pa (0 mmH ₂ O)	0 Pa (0 mmH ₂ O)		
Compressor	Type		Inverter scroll hermetic compressor	Inverter scroll hermetic compressor	
	Manufacture		AC&R Works, MITSUBISHI ELECTRIC CORPORATION	AC&R Works, MITSUBISHI ELECTRIC CORPORATION	
	Starting method		Inverter	Inverter	
	Motor output	kW	10.9	12.4	
	Case heater	kW	-	-	
Lubricant		MEL32	MEL32		
External finish		Pre-coated galvanized steel sheets (+powder coating for -BS type) <MUNSELL 5Y 8/1 or similar>		Pre-coated galvanized steel sheets (+powder coating for -BS type) <MUNSELL 5Y 8/1 or similar>	
External dimension H x W x D		mm	1,710 (1,650 without legs) x 1,220 x 740	1,710 (1,650 without legs) x 1,750 x 740	
		in.	67-3/8 (65 without legs) x 48-1/16 x 29-3/16	67-3/8 (65 without legs) x 68-15/16 x 29-3/16	
Protection devices	High pressure protection		High pressure sensor, High pressure switch at 4.15 MPa (601 psi)	High pressure sensor, High pressure switch at 4.15 MPa (601 psi)	
	Inverter circuit (COMP./FAN)		Over-heat protection, Over-current protection	Over-heat protection, Over-current protection	
	Compressor		-	-	
	Fan motor		-	-	
Refrigerant	Type x original charge		R410A x 10.3 kg (23 lbs)	R410A x 11.8 kg (27 lbs)	
	Control		HBC controller	HBC controller	
Net weight	kg (lbs)	246 (543)	321 (708)		
Heat exchanger		Salt-resistant cross fin & copper tube		Salt-resistant cross fin & copper tube	
HIC circuit (HIC: Heat Inter-Changer)		-		-	
Defrosting method		Auto-defrost mode (Reversed refrigerant cycle, Hot gas)		Auto-defrost mode (Reversed refrigerant cycle, Hot gas)	
Drawing	External	WKJ94T177		WKJ94T178	
	Wiring	WKE94G041		WKE94G042	
Standard attachment	Document	Installation Manual		Installation Manual	
	Accessory	Refrigerant conn. pipe		Refrigerant conn. pipe	
Optional parts		Main HBC controller: CMB-WP108,1016V-GA1 Sub HBC controller: CMB-WP108,1016V-GB1		Main HBC controller: CMB-WP108,1016V-GA1 Sub HBC controller: CMB-WP108,1016V-GB1	
Remarks		Details on foundation work, duct work, insulation work, electrical wiring, power source switch, and other items shall be referred to the Installation Manual. Due to continuing improvement, above specifications may be subject to change without notice.		Details on foundation work, duct work, insulation work, electrical wiring, power source switch, and other items shall be referred to the Installation Manual. Due to continuing improvement, above specifications may be subject to change without notice.	

Notes:

- Nominal cooling conditions (subject to JIS B8615-2)
Indoor: 27°C D.B./19°C W.B. (81°F D.B./66°F W.B.), Outdoor: 35°C D.B./24°C W.B. (95°F D.B./75°F W.B.)
Pipe length: 7.5 m (24-9/16 ft.), Level difference: 0 m (0 ft.)
- Nominal heating conditions (subject to JIS B8615-2)
Indoor: 20°C D.B. (68°F D.B.), Outdoor: 7°C D.B./6°C W.B. (45°F D.B./43°F W.B.)
Pipe length: 7.5 m (24-9/16 ft.), Level difference: 0 m (0 ft.)
- 5°C D.B. (23°F D.B.)/-6°C W.B. (21°F W.B.) to 21°C D.B. (70°F D.B.)/15.5°C W.B. (60°F W.B.)
with cooling/heating mixed operation.
- External static pressure option is available (30 Pa, 60 Pa/3.1 mmH₂O, 6.1 mmH₂O).

Unit converter

BTU/h	=kW x 3,412
cfm	=m ³ /min x 35.31
lbs	=kg/0.4536

*Above specification data is subject to rounding variation.

1. SPECIFICATIONS

OUTDOOR

Model			PURY-P500YLM-A1 (-BS)		
Power source			3-phase 4-wire 380-400-415 V 50/60 Hz		
Cooling capacity (Nominal)	*1	kW	56.0		
		kcal/h	50,000		
		BTU/h	191,100		
	Power input	kW	22.67		
		Current input	A	38.2-38.3-35.0	
		EER	kW/kW	2.47	
Temp. range of cooling	*3	Indoor	W.B.	15.0~24.0°C (59~75°F)	
		Outdoor	D.B.	-5.0~46.0°C (23~115°F)	
Heating capacity (Nominal)	*2	kW	58.0		
		kcal/h	50,000		
		BTU/h	197,900		
	Power input	kW	17.53		
		Current input	A	29.5-28.1-27.0	
		COP	kW/kW	3.30	
Temp. range of heating	*3	Indoor	D.B.	15.0~27.0°C (59~81°F)	
		Outdoor	W.B.	-20.0~15.5°C (-4~60°F)	
Indoor unit connectable	Total capacity		50~150% of outdoor unit capacity		
	Model/Quantity		WP15-WP50/5-50		
Sound pressure level (measured in anechoic room)		dB <A>	63.5		
Sound power level (measured in anechoic room)		dB <A>	87		
Refrigerant piping diameter	High pressure	mm (in.)	22.2 (7/8) Brazed		
	Low pressure	mm (in.)	28.58 (1-1/8) Brazed		
FAN	Type x Quantity		Propeller fan x 2		
	Air flow rate	m ³ /min	380		
		L/s	6,333		
		cfm	13,418		
	Control, Driving mechanism		Inverter-control, Direct-driven by motor		
	Motor output	kW	0.92 x 2		
*4	External static press.		0 Pa (0 mmH ₂ O)		
Compressor	Type		Inverter scroll hermetic compressor		
	Manufacture		AC&R Works, MITSUBISHI ELECTRIC CORPORATION		
	Starting method		Inverter		
	Motor output	kW	13.4		
	Case heater	kW	-		
	Lubricant		MEL32		
External finish			Pre-coated galvanized steel sheets (+powder coating for -BS type) <MUNSELL 5Y 8/1 or similar>		
External dimension H x W x D		mm	1,710 (1,650 without legs) x 1,750 x 740		
		in.	67-3/8 (65 without legs) x 68-15/16 x 29-3/16		
Protection devices	High pressure protection		High pressure sensor, High pressure switch at 4.15 MPa (601 psi)		
	Inverter circuit (COMP./FAN)		Over-heat protection, Over-current protection		
	Compressor		-		
	Fan motor		-		
Refrigerant	Type x original charge		R410A x 11.8 kg (27 lbs)		
	Control		HBC controller		
Net weight		kg (lbs)	321 (708)		
Heat exchanger			Salt-resistant cross fin & copper tube		
HIC circuit (HIC: Heat Inter-Changer)			-		
Defrosting method			Auto-defrost mode (Reversed refrigerant cycle, Hot gas)		
Drawing	External		WKJ94T178		
	Wiring		WKE94G042		
Standard attachment	Document		Installation Manual		
	Accessory		Refrigerant conn. pipe		
Optional parts			Main HBC controller: CMB-WP108,1016V-GA1 Sub HBC controller: CMB-WP108,1016V-GB1		
Remarks			Details on foundation work, duct work, insulation work, electrical wiring, power source switch, and other items shall be referred to the Installation Manual. Due to continuing improvement, above specifications may be subject to change without notice.		

Notes:	Unit converter
1.Nominal cooling conditions (subject to JIS B8615-2) Indoor: 27°C D.B./19°C W.B. (81°F D.B./66°F W.B.), Outdoor: 35°C D.B./24°C W.B. (95°F D.B./75°F W.B.) Pipe length: 7.5 m (24-9/16 ft.), Level difference: 0 m (0 ft.)	BTU/h =kW x 3,412
2.Nominal heating conditions (subject to JIS B8615-2) Indoor: 20°C D.B. (68°F D.B.), Outdoor: 7°C D.B./6°C W.B. (45°F D.B./43°F W.B.) Pipe length: 7.5 m (24-9/16 ft.), Level difference: 0 m (0 ft.)	cfm =m ³ /min x 35.31
3.-5°C D.B. (23°F D.B.)/-6°C W.B. (21°F W.B.) to 21°C D.B. (70°F D.B.)/15.5°C W.B. (60°F W.B.) with cooling/heating mixed operation.	lbs =kg/0.4536
4.External static pressure option is available (30 Pa, 60 Pa/3.1 mmH ₂ O, 6.1 mmH ₂ O).	*Above specification data is subject to rounding variation.

1. SPECIFICATIONS

Model		PURY-EP200YLM-A1 (-BS)		PURY-EP250YLM-A1 (-BS)	
Power source		3-phase 4-wire 380-400-415 V 50/60 Hz		3-phase 4-wire 380-400-415 V 50/60 Hz	
Cooling capacity (Nominal)	*1	kW	22.4	28.0	
		kcal/h	20,000	25,000	
		BTU/h	76,400	95,500	
	Power input	kW	6.27	8.77	
		A	10.5-10.0-9.6	14.8-14.0-13.5	
EER	kW/kW	3.57	3.19		
Temp. range of cooling	*3 Indoor	W.B.	15.0~24.0°C (59~75°F)	15.0~24.0°C (59~75°F)	
	Outdoor	D.B.	-5.0~46.0°C (23~115°F)	-5.0~46.0°C (23~115°F)	
Heating capacity (Nominal)	*2	kW	25.0	31.5	
		kcal/h	21,500	27,100	
		BTU/h	85,300	107,500	
	Power input	kW	6.92	9.84	
		A	11.6-11.0-10.6	16.6-15.7-15.2	
COP	kW/kW	3.61	3.20		
Temp. range of heating	*3 Indoor	D.B.	15.0~27.0°C (59~81°F)	15.0~27.0°C (59~81°F)	
	Outdoor	W.B.	-20.0~15.5°C (-4~60°F)	-20.0~15.5°C (-4~60°F)	
Indoor unit connectable	Total capacity		50~150% of outdoor unit capacity	50~150% of outdoor unit capacity	
	Model/Quantity		WP15-WP50/2~20	WP15-WP50/3~25	
Sound pressure level (measured in anechoic room)		dB <A>	59	60	
Sound power level (measured in anechoic room)		dB <A>	82.5	83.5	
Refrigerant piping diameter	High pressure	mm (in.)	15.88 (5/8) Brazed	19.05 (3/4) Brazed	
	Low pressure	mm (in.)	19.05 (3/4) Brazed	22.2 (7/8) Brazed	
FAN	Type x Quantity		Propeller fan x 1	Propeller fan x 1	
	Air flow rate	m ³ /min	185	185	
		L/s	3,083	3,083	
		cfm	6,532	6,532	
	Control, Driving mechanism		Inverter-control, Direct-driven by motor	Inverter-control, Direct-driven by motor	
	Motor output	kW	0.92 x 1	0.92 x 1	
*4 External static press.		0 Pa (0 mmH ₂ O)	0 Pa (0 mmH ₂ O)		
Compressor	Type		Inverter scroll hermetic compressor	Inverter scroll hermetic compressor	
	Manufacture		AC&R Works, MITSUBISHI ELECTRIC CORPORATION	AC&R Works, MITSUBISHI ELECTRIC CORPORATION	
	Starting method		Inverter	Inverter	
	Motor output	kW	5.6	6.9	
	Case heater	kW	-	-	
Lubricant		MEL32	MEL32		
External finish		Pre-coated galvanized steel sheets (+powder coating for -BS type) <MUNSELL 5Y 8/1 or similar>		Pre-coated galvanized steel sheets (+powder coating for -BS type) <MUNSELL 5Y 8/1 or similar>	
External dimension H x W x D		mm	1,710 (1,650 without legs) x 920 x 740	1,710 (1,650 without legs) x 920 x 740	
		in.	67-3/8 (65 without legs) x 36-1/4 x 29-3/16	67-3/8 (65 without legs) x 36-1/4 x 29-3/16	
Protection devices	High pressure protection		High pressure sensor, High pressure switch at 4.15 MPa (601 psi)	High pressure sensor, High pressure switch at 4.15 MPa (601 psi)	
	Inverter circuit (COMP./FAN)		Over-heat protection, Over-current protection	Over-heat protection, Over-current protection	
	Compressor		-	-	
	Fan motor		-	-	
Refrigerant	Type x original charge		R410A x 6.0 kg (14 lbs)	R410A x 6.0 kg (14 lbs)	
	Control		HBC controller	HBC controller	
Net weight	kg (lbs)	202 (446)	202 (446)		
Heat exchanger		Salt-resistant cross fin & aluminium tube		Salt-resistant cross fin & aluminium tube	
HIC circuit (HIC: Heat Inter-Changer)		-		-	
Defrosting method		Auto-defrost mode (Reversed refrigerant cycle, Hot gas)		Auto-defrost mode (Reversed refrigerant cycle, Hot gas)	
Drawing	External	WKJ94T756		WKJ94T756	
	Wiring	WKE94G041		WKE94G041	
Standard attachment	Document	Installation Manual		Installation Manual	
	Accessory	Refrigerant conn. pipe		Refrigerant conn. pipe	
Optional parts		Main HBC controller: CMB-WP108,1016V-GA1 Sub HBC controller: CMB-WP108,1016V-GB1		Main HBC controller: CMB-WP108,1016V-GA1 Sub HBC controller: CMB-WP108,1016V-GB1	
Remarks		Details on foundation work, duct work, insulation work, electrical wiring, power source switch, and other items shall be referred to the Installation Manual. Due to continuing improvement, above specifications may be subject to change without notice.		Details on foundation work, duct work, insulation work, electrical wiring, power source switch, and other items shall be referred to the Installation Manual. Due to continuing improvement, above specifications may be subject to change without notice.	

Notes:

- Nominal cooling conditions (subject to JIS B8615-2)
Indoor: 27°C D.B./19°C W.B. (81°F D.B./66°F W.B.), Outdoor: 35°C D.B./24°C W.B. (95°F D.B./75°F W.B.)
Pipe length: 7.5 m (24-9/16 ft.), Level difference: 0 m (0 ft.)
- Nominal heating conditions (subject to JIS B8615-2)
Indoor: 20°C D.B. (68°F D.B.), Outdoor: 7°C D.B./6°C W.B. (45°F D.B./43°F W.B.)
Pipe length: 7.5 m (24-9/16 ft.), Level difference: 0 m (0 ft.)
- 5°C D.B. (23°F D.B.)/-6°C W.B. (21°F W.B.) to 21°C D.B. (70°F D.B.)/15.5°C W.B. (60°F W.B.)
with cooling/heating mixed operation.
- External static pressure option is available (30 Pa, 60 Pa/3.1 mmH₂O, 6.1 mmH₂O).

Unit converter

BTU/h	=kW x 3,412
cfm	=m ³ /min x 35.31
lbs	=kg/0.4536

*Above specification data is subject to rounding variation.

1. SPECIFICATIONS

OUTDOOR

Model		PURY-EP300YLM-A1 (-BS)		
Number of HBC controller		Single HBC	Double HBC	
Power source		3-phase 4-wire 380-400-415 V 50/60 Hz		
Cooling capacity (Nominal)	*1 kW	33.5		
	kcal/h	28,800		
	*1 BTU/h	114,300		
	Power input kW	12.05	10.24	
	Current input A	20.3-19.3-18.6	17.2-16.4-15.8	
EER	kW/kW	2.78	3.27	
Temp. range of cooling	*3 Indoor	W.B.	15.0~24.0°C (59~75°F)	
	Outdoor	D.B.	-5.0~46.0°C (23~115°F)	
Heating capacity (Nominal)	*2 kW	37.5		
	kcal/h	32,300		
	*2 BTU/h	128,000		
	Power input kW	11.71	11.12	
	Current input A	19.7-18.7-18.1	18.7-17.8-17.1	
COP	kW/kW	3.20	3.37	
Temp. range of heating	*3 Indoor	D.B.	15.0~27.0°C (59~81°F)	
	Outdoor	W.B.	-20.0~15.5°C (-4~60°F)	
Indoor unit connectable	Total capacity		50~150% of outdoor unit capacity	
	Model/Quantity		WP15-WP50/3~30	
Sound pressure level (measured in anechoic room)	dB <A>	62.5		
Sound power level (measured in anechoic room)	dB <A>	86		
Refrigerant piping diameter	High pressure	mm (in.)	19.05 (3/4) Brazed	
	Low pressure	mm (in.)	22.2 (7/8) Brazed	
FAN	Type x Quantity		Propeller fan x 1	
	Air flow rate	m ³ /min	230	
		L/s	3,833	
		cfm	8,121	
	Control, Driving mechanism		Inverter-control, Direct-driven by motor	
*4 Motor output	kW	0.92 x 1		
External static press.		0 Pa (0 mmH ₂ O)		
Compressor	Type			Inverter scroll hermetic compressor
	Manufacture			AC&R Works, MITSUBISHI ELECTRIC CORPORATION
	Starting method			Inverter
	Motor output	kW	8.1	
	Case heater	kW	-	
	Lubricant			MEL32
External finish		Pre-coated galvanized steel sheets (+powder coating for -BS type) <MUNSELL 5Y 8/1 or similar>		
External dimension H x W x D	mm	1,710 (1,650 without legs) x 1,220 x 740		
	in.	67-3/8 (65 without legs) x 48-1/16 x 29-3/16		
Protection devices	High pressure protection		High pressure sensor, High pressure switch at 4.15 MPa (601 psi)	
	Inverter circuit (COMP./FAN)		Over-heat protection, Over-current protection	
	Compressor		-	
	Fan motor		-	
Refrigerant	Type x original charge		R410A x 8.0 kg (18 lbs)	
	Control		HBC controller	
Net weight	kg (lbs)	244 (538)		
Heat exchanger		Salt-resistant cross fin & aluminium tube		
HIC circuit (HIC: Heat Inter-Changer)		-		
Defrosting method		Auto-defrost mode (Reversed refrigerant cycle, Hot gas)		
Drawing	External	WKJ94T757		
	Wiring	WKE94G041		
Standard attachment	Document			Installation Manual
	Accessory			Refrigerant conn. pipe
Optional parts		Main HBC controller: CMB-WP108, 1016V-GA1 Sub HBC controller: CMB-WP108, 1016V-GB1		
Remarks		Details on foundation work, duct work, insulation work, electrical wiring, power source switch, and other items shall be referred to the Installation Manual. Due to continuing improvement, above specifications may be subject to change without notice.		

Notes:	Unit converter
1.Nominal cooling conditions (subject to JIS B8615-2) Indoor: 27°C D.B./19°C W.B. (81°F D.B./66°F W.B.), Outdoor: 35°C D.B. (95°F D.B.) Pipe length: 7.5 m (24-9/16 ft.), Level difference: 0 m (0 ft.)	BTU/h =kW x 3,412
2.Nominal heating conditions (subject to JIS B8615-2) Indoor: 20°C D.B. (68°F D.B.), Outdoor: 7°C D.B./6°C W.B. (45°F D.B./43°F W.B.) Pipe length: 7.5 m (24-9/16 ft.), Level difference: 0 m (0 ft.)	cfm =m ³ /min x 35.31
3.-5°C D.B. (23°F D.B.)/-6°C W.B. (21°F W.B.) to 21°C D.B. (70°F D.B.)/15.5°C W.B. (60°F W.B.) with cooling/heating mixed operation.	lbs =kg/0.4536
4.External static pressure option is available (30 Pa, 60 Pa/3.1 mmH ₂ O, 6.1 mmH ₂ O).	*Above specification data is subject to rounding variation.

1. SPECIFICATIONS

Model		PURY-EP350YLM-A1 (-BS)	
Number of HBC controller		Single HBC	Double HBC
Power source		3-phase 4-wire 380-400-415 V 50/60 Hz	
Cooling capacity (Nominal)	*1 kW	40.0	
	kcal/h	34,400	
	*1 BTU/h	136,500	
	Power input	17.16	13.98
	Current input	28.9-27.5-26.5	23.6-22.4-21.6
EER	kW/kW	2.33	2.86
Temp. range of cooling	*3 Indoor	W.B.	15.0~24.0°C (59~75°F)
	Outdoor	D.B.	-5.0~46.0°C (23~115°F)
Heating capacity (Nominal)	*2 kW	45.0	
	kcal/h	38,700	
	*2 BTU/h	153,500	
	Power input	15.38	14.28
	Current input	25.9-24.6-23.7	24.1-22.9-22.0
COP	kW/kW	2.92	3.15
Temp. range of heating	*3 Indoor	D.B.	15.0~27.0°C (59~81°F)
	Outdoor	W.B.	-20.0~15.5°C (-4~60°F)
Indoor unit connectable	Total capacity	50~150% of outdoor unit capacity	
	Model/Quantity	WP15-WP50/4~35	
Sound pressure level (measured in anechoic room)	dB <A>	62.5	
Sound power level (measured in anechoic room)	dB <A>	86	
Refrigerant piping diameter	High pressure	mm (in.)	19.05 (3/4) Brazed
	Low pressure	mm (in.)	28.58 (1-1/8) Brazed
FAN	Type x Quantity	Propeller fan x 1	
	Air flow rate	m ³ /min	230
		L/s	3,833
		cfm	8,121
	Control, Driving mechanism	Inverter-control, Direct-driven by motor	
*4 Motor output	kW	0.92 x 1	
External static press.		0 Pa (0 mmH ₂ O)	
Compressor	Type	Inverter scroll hermetic compressor	
	Manufacture	AC&R Works, MITSUBISHI ELECTRIC CORPORATION	
	Starting method	Inverter	
	Motor output	kW	10.5
	Case heater	kW	-
	Lubricant	MEL32	
External finish	Pre-coated galvanized steel sheets (+powder coating for -BS type) <MUNSELL 5Y 8/1 or similar>		
External dimension H x W x D	mm	1,710 (1,650 without legs) x 1,220 x 740	
	in.	67-3/8 (65 without legs) x 48-1/16 x 29-3/16	
Protection devices	High pressure protection	High pressure sensor, High pressure switch at 4.15 MPa (601 psi)	
	Inverter circuit (COMP./FAN)	Over-heat protection, Over-current protection	
	Compressor	-	
	Fan motor	-	
Refrigerant	Type x original charge	R410A x 8.0 kg (18 lbs)	
	Control	HBC controller	
Net weight	kg (lbs)	244 (538)	
Heat exchanger	Salt-resistant cross fin & aluminium tube		
HIC circuit (HIC: Heat Inter-Changer)	-		
Defrosting method	Auto-defrost mode (Reversed refrigerant cycle)		
Drawing	External	WKJ94LT757	
	Wiring	WKE94G041	
Standard attachment	Document	Installation Manual	
	Accessory	Refrigerant conn. pipe	
Optional parts	Main HBC controller: CMB-WP108, 1016V-GA1 Sub HBC controller: CMB-WP108, 1016V-GB1		
Remarks	Details on foundation work, duct work, insulation work, electrical wiring, power source switch, and other items shall be referred to the Installation Manual. Due to continuing improvement, above specifications may be subject to change without notice.		

Notes:	Unit converter
1.Nominal cooling conditions (subject to JIS B8615-2) Indoor: 27°C D.B./19°C W.B. (81°F D.B./66°F W.B.), Outdoor: 35°C D.B. (95°F D.B.) Pipe length: 7.5 m (24-9/16 ft.), Level difference: 0 m (0 ft.)	BTU/h =kW x 3,412
2.Nominal heating conditions (subject to JIS B8615-2) Indoor: 20°C D.B. (68°F D.B.), Outdoor: 7°C D.B./6°C W.B. (45°F D.B./43°F W.B.) Pipe length: 7.5 m (24-9/16 ft.), Level difference: 0 m (0 ft.)	cfm =m ³ /min x 35.31
3.-5°C D.B. (23°F D.B.)/-6°C W.B. (21°F W.B.) to 21°C D.B. (70°F D.B.)/15.5°C W.B. (60°F W.B.) with cooling/heating mixed operation.	lbs =kg/0.4536
4.External static pressure option is available (30 Pa, 60 Pa/3.1 mmH ₂ O, 6.1 mmH ₂ O).	*Above specification data is subject to rounding variation.

1. SPECIFICATIONS

OUTDOOR

Model			PURY-EP400YLM-A1 (-BS)	PURY-EP450YLM-A1 (-BS)		
Power source			3-phase 4-wire 380-400-415 V 50/60 Hz			
Cooling capacity (Nominal)	*1	kW	45.0	50.0		
		kcal/h	40,000	45,000		
		BTU/h	153,500	170,600		
	*1	Power input	kW	13.88	16.83	
		Current input	A	23.4-22.2-21.4	28.4-26.9-26.0	
		EER	kW/kW	3.24	2.97	
Temp. range of cooling	*3	Indoor	W.B.	15.0~24.0°C (59~75°F)		
		Outdoor	D.B.	-5.0~46.0°C (23~115°F)		
Heating capacity (Nominal)	*2	kW	50.0	56.0		
		kcal/h	43,000	50,000		
		BTU/h	170,600	191,100		
	*2	Power input	kW	14.12	16.86	
		Current input	A	23.8-22.6-21.8	28.4-27.0-26.0	
		COP	kW/kW	3.54	3.32	
Temp. range of heating	*3	Indoor	D.B.	15.0~27.0°C (59~81°F)		
		Outdoor	W.B.	-20.0~15.5°C (-4~60°F)		
Indoor unit connectable	Total capacity		50~150% of outdoor unit capacity			
	Model/Quantity		WP15-WP50/4~40			
Sound pressure level (measured in anechoic room)		dB <A>	62.5	62.5		
Sound power level (measured in anechoic room)		dB <A>	86	86		
Refrigerant piping diameter	High pressure	mm (in.)	22.2 (7/8) Brazed	22.2 (7/8) Brazed		
	Low pressure	mm (in.)	28.58 (1-1/8) Brazed	28.58 (1-1/8) Brazed		
FAN	Type x Quantity		Propeller fan x 2			
	Air flow rate	m ³ /min	320	320		
		L/s	5,333	5,333		
		cfm	11,299	11,299		
	Control, Driving mechanism		Inverter-control, Direct-driven by motor			
	Motor output	kW	0.92 x 2	0.92 x 2		
*4 External static press.		0 Pa (0 mmH ₂ O)				
Compressor	Type		Inverter scroll hermetic compressor			
	Manufacture		AC&R Works, MITSUBISHI ELECTRIC CORPORATION			
	Starting method		Inverter			
	Motor output	kW	10.9	12.4		
	Case heater	kW	-	-		
	Lubricant		MEL32			
External finish		Pre-coated galvanized steel sheets (+powder coating for -BS type) <MUNSELL 5Y 8/1 or similar>				
External dimension H x W x D	mm		1,710 (1,650 without legs) x 1,750 x 740			
	in.		67-3/8 (65 without legs) x 68-15/16 x 29-3/16			
Protection devices	High pressure protection		High pressure sensor, High pressure switch at 4.15 MPa (601 psi)			
	Inverter circuit (COMP./FAN)		Over-heat protection, Over-current protection			
	Compressor		-			
	Fan motor		-			
Refrigerant	Type x original charge		R410A x 10.5 kg (24 lbs)			
	Control		HBC controller			
Net weight	kg (lbs)		315 (695)	336 (741)		
Heat exchanger		Salt-resistant cross fin & aluminium tube				
HIC circuit (HIC: Heat Inter-Changer)		-				
Defrosting method		Auto-defrost mode (Reversed refrigerant cycle, Hot gas)				
Drawing	External	WKJ94T758				
	Wiring	WKE94G042				
Standard attachment	Document	Installation Manual				
	Accessory	Refrigerant conn. pipe				
Optional parts		Main HBC controller: CMB-WP108,1016V-GA1 Sub HBC controller: CMB-WP108,1016V-GB1		Main HBC controller: CMB-WP108,1016V-GA1 Sub HBC controller: CMB-WP108,1016V-GB1		
Remarks		Details on foundation work, duct work, insulation work, electrical wiring, power source switch, and other items shall be referred to the Installation Manual. Due to continuing improvement, above specifications may be subject to change without notice.			Details on foundation work, duct work, insulation work, electrical wiring, power source switch, and other items shall be referred to the Installation Manual. Due to continuing improvement, above specifications may be subject to change without notice.	

Notes:	Unit converter
1. Nominal cooling conditions (subject to JIS B8615-2) Indoor: 27°C D.B./19°C W.B. (81°F D.B./66°F W.B.), Outdoor: 35°C D.B./24°C W.B. (95°F D.B./75°F W.B.) Pipe length: 7.5 m (24-9/16 ft.), Level difference: 0 m (0 ft.)	BTU/h = kW x 3,412
2. Nominal heating conditions (subject to JIS B8615-2) Indoor: 20°C D.B. (68°F D.B.), Outdoor: 7°C D.B./6°C W.B. (45°F D.B./43°F W.B.) Pipe length: 7.5 m (24-9/16 ft.), Level difference: 0 m (0 ft.)	cfm = m ³ /min x 35.31
3. 5°C D.B. (23°F D.B.)/6°C W.B. (21°F W.B.) to 21°C D.B. (70°F D.B.)/15.5°C W.B. (60°F W.B.) with cooling/heating mixed operation.	lbs = kg/0.4536
4. External static pressure option is available (30 Pa, 60 Pa/3.1 mmH ₂ O, 6.1 mmH ₂ O).	*Above specification data is subject to rounding variation.

1. SPECIFICATIONS

Model		PURY-EP500YLM-A1 (-BS)	
Power source		3-phase 4-wire 380-400-415 V 50/60 Hz	
Cooling capacity (Nominal)	*1 kW	56.0	
	kcal/h	50,000	
	*1 BTU/h	191,100	
	Power input	kW	21.22
	Current input	A	35.8-34.0-32.8
	EER	kW/kW	2.63
Temp. range of cooling	*3 Indoor	W.B.	15.0~24.0°C (59~75°F)
	Outdoor	D.B.	-5.0~46.0°C (23~115°F)
Heating capacity (Nominal)	*2 kW	63.0	
	kcal/h	54,200	
	*2 BTU/h	215,000	
	Power input	kW	21.67
	Current input	A	36.5-34.7-33.4
	COP	kW/kW	2.90
Temp. range of heating	*3 Indoor	D.B.	15.0~27.0°C (59~81°F)
	Outdoor	W.B.	-20.0~15.5°C (-4~60°F)
Indoor unit connectable	Total capacity		50~150% of outdoor unit capacity
	Model/Quantity		WP15-WP50/5~50
Sound pressure level (measured in anechoic room)		dB <A>	63.5
Sound power level (measured in anechoic room)		dB <A>	87
Refrigerant piping diameter	High pressure	mm (in.)	22.2 (7/8) Brazed
	Low pressure	mm (in.)	28.58 (1-1/8) Brazed
FAN	Type x Quantity		Propeller fan x 2
	Air flow rate	m ³ /min	380
		L/s	6,333
		cfm	13,418
	Control, Driving mechanism		Inverter-control, Direct-driven by motor
*4 Motor output	kW	0.92 x 2	
External static press.		0 Pa (0 mmH ₂ O)	
Compressor	Type		Inverter scroll hermetic compressor
	Manufacture		AC&R Works, MITSUBISHI ELECTRIC CORPORATION
	Starting method		Inverter
	Motor output	kW	13.4
	Case heater	kW	0.045 (240V)
Lubricant		MEL32	
External finish		Pre-coated galvanized steel sheets (+powder coating for -BS type) <MUNSELL 5Y 8/1 or similar>	
External dimension H x W x D	mm		1,710 (1,650 without legs) x 1,750 x 740
	in.		67-3/8 (65 without legs) x 68-15/16 x 29-3/16
Protection devices	High pressure protection		High pressure sensor, High pressure switch at 4.15 MPa (601 psi)
	Inverter circuit (COMP./FAN)		Over-heat protection, Over-current protection
	Compressor		-
	Fan motor		-
Refrigerant	Type x original charge		R410A x 11.8 kg (27 lbs)
	Control		HBC controller
Net weight	kg (lbs)		349 (770)
Heat exchanger		Salt-resistant cross fin & aluminium tube	
HIC circuit (HIC: Heat Inter-Changer)		-	
Defrosting method		Auto-defrost mode (Reversed refrigerant cycle, Hot gas)	
Drawing	External		WKJ94T758
	Wiring		WKE94G044
Standard attachment	Document		Installation Manual
	Accessory		Refrigerant conn. pipe
Optional parts		Main HBC controller: CMB-WP108,1016V-GA1 Sub HBC controller: CMB-WP108,1016V-GB1	
Remarks		Details on foundation work, duct work, insulation work, electrical wiring, power source switch, and other items shall be referred to the Installation Manual. Due to continuing improvement, above specifications may be subject to change without notice.	

Notes:	Unit converter
1.Nominal cooling conditions (subject to JIS B8615-2) Indoor: 27°C D.B./19°C W.B. (81°F D.B./66°F W.B.), Outdoor: 35°C D.B./24°C W.B. (95°F D.B./75°F W.B.) Pipe length: 7.5 m (24-9/16 ft.), Level difference: 0 m (0 ft.)	BTU/h =kW x 3,412
2.Nominal heating conditions (subject to JIS B8615-2) Indoor: 20°C D.B. (68°F D.B.), Outdoor: 7°C D.B./6°C W.B. (45°F D.B./43°F W.B.) Pipe length: 7.5 m (24-9/16 ft.), Level difference: 0 m (0 ft.)	cfm =m ³ /min x 35.31
3.-5°C D.B. (23°F D.B.)/-6°C W.B. (21°F W.B.) to 21°C D.B. (70°F D.B.)/15.5°C W.B. (60°F W.B.) with cooling/heating mixed operation.	lbs =kg/0.4536
4.External static pressure option is available (30 Pa, 60 Pa/3.1 mmH ₂ O, 6.1 mmH ₂ O).	*Above specification data is subject to rounding variation.

2. CAPACITY TABLES

OUTDOOR

2-1. Correction by temperature

CITY MULTI could have varied capacity at different designing temperature. Using the nominal cooling/heating capacity value and the ratio below, the capacity can be observed at various temperature.

PURY-		P200YLM-A1	P250YLM-A1
Nominal Cooling Capacity	kW	22.4	28.0
	BTU/h	76,400	95,500
Input	kW	7.00	9.92

PURY-		EP200YLM-A1	EP250YLM-A1
Nominal Cooling Capacity	kW	22.4	28.0
	BTU/h	76,400	95,500
Input	kW	6.27	8.77

Indoor unit temperature correction

To be used to correct indoor unit capacity only

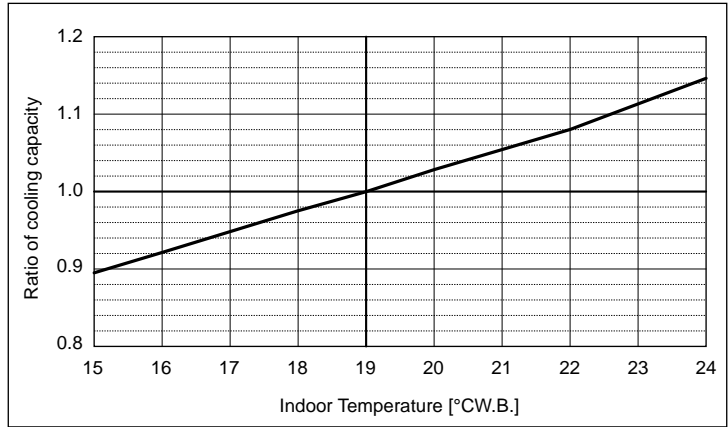

Outdoor unit temperature correction

To be used to correct outdoor unit only

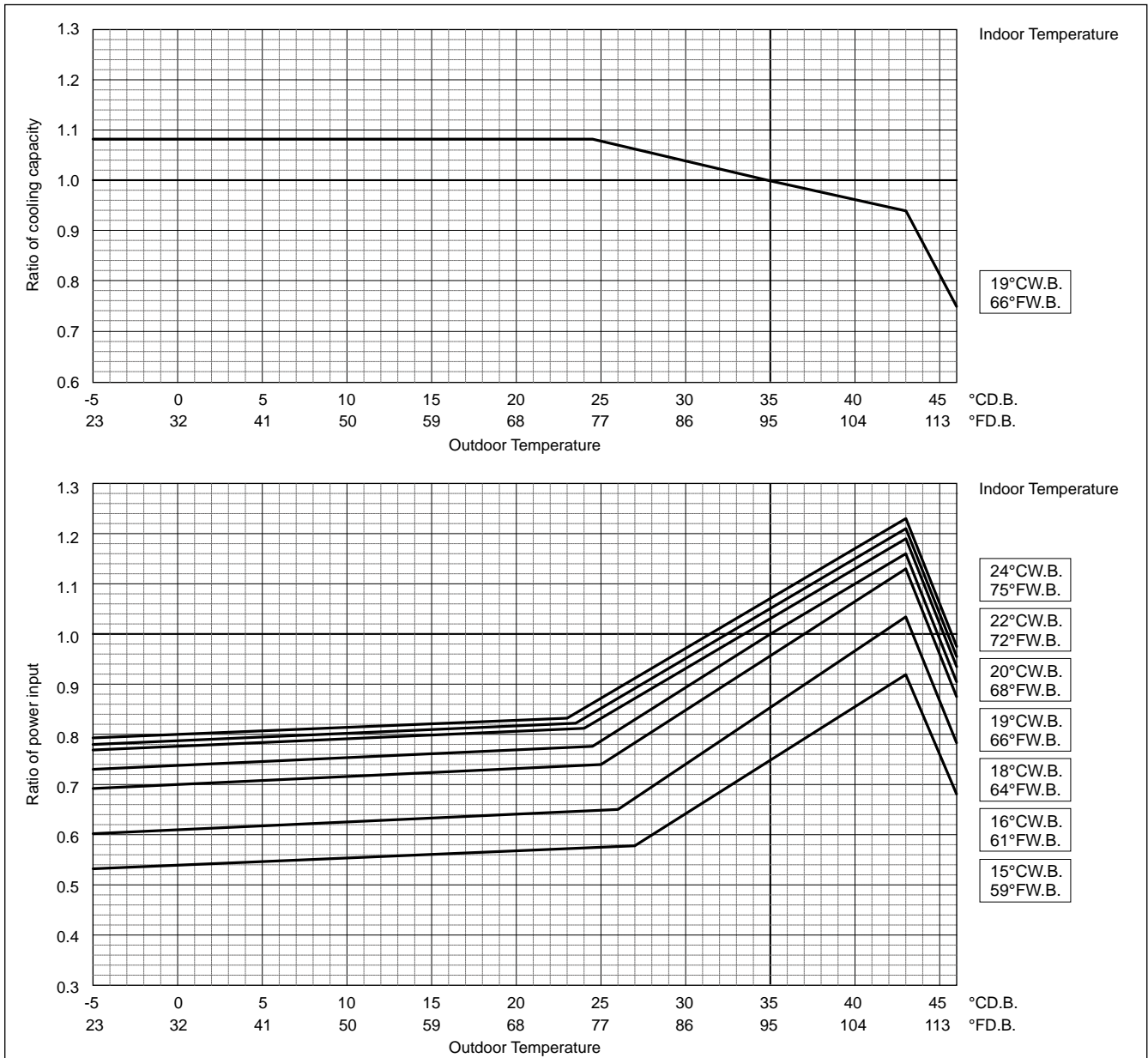

Outdoor unit power input is affected by the indoor and outdoor temperatures as shown in the graph above. Please consult the sales office for details.

2. CAPACITY TABLES

	PURY-	P200YLM-A1	P250YLM-A1
Nominal Heating Capacity	kW	25.0	31.5
	BTU/h	85,300	107,500
Input	kW	7.08	10.06

	PURY-	EP200YLM-A1	EP250YLM-A1
Nominal Heating Capacity	kW	25.0	31.5
	BTU/h	85,300	107,500
Input	kW	6.92	9.84

Indoor unit temperature correction

To be used to correct indoor unit capacity only

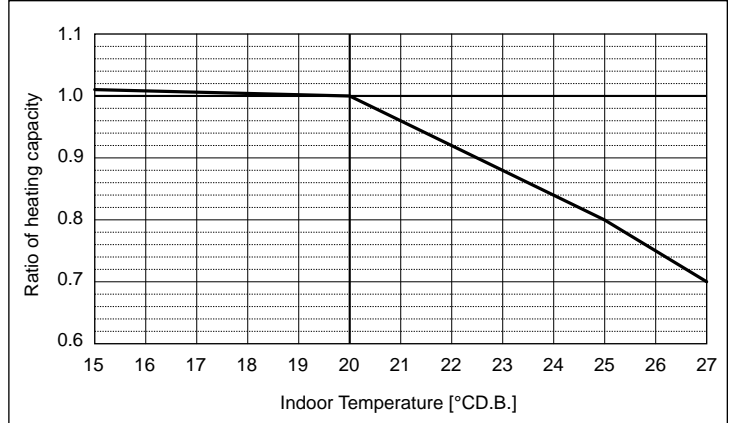

Outdoor unit temperature correction

To be used to correct outdoor unit only

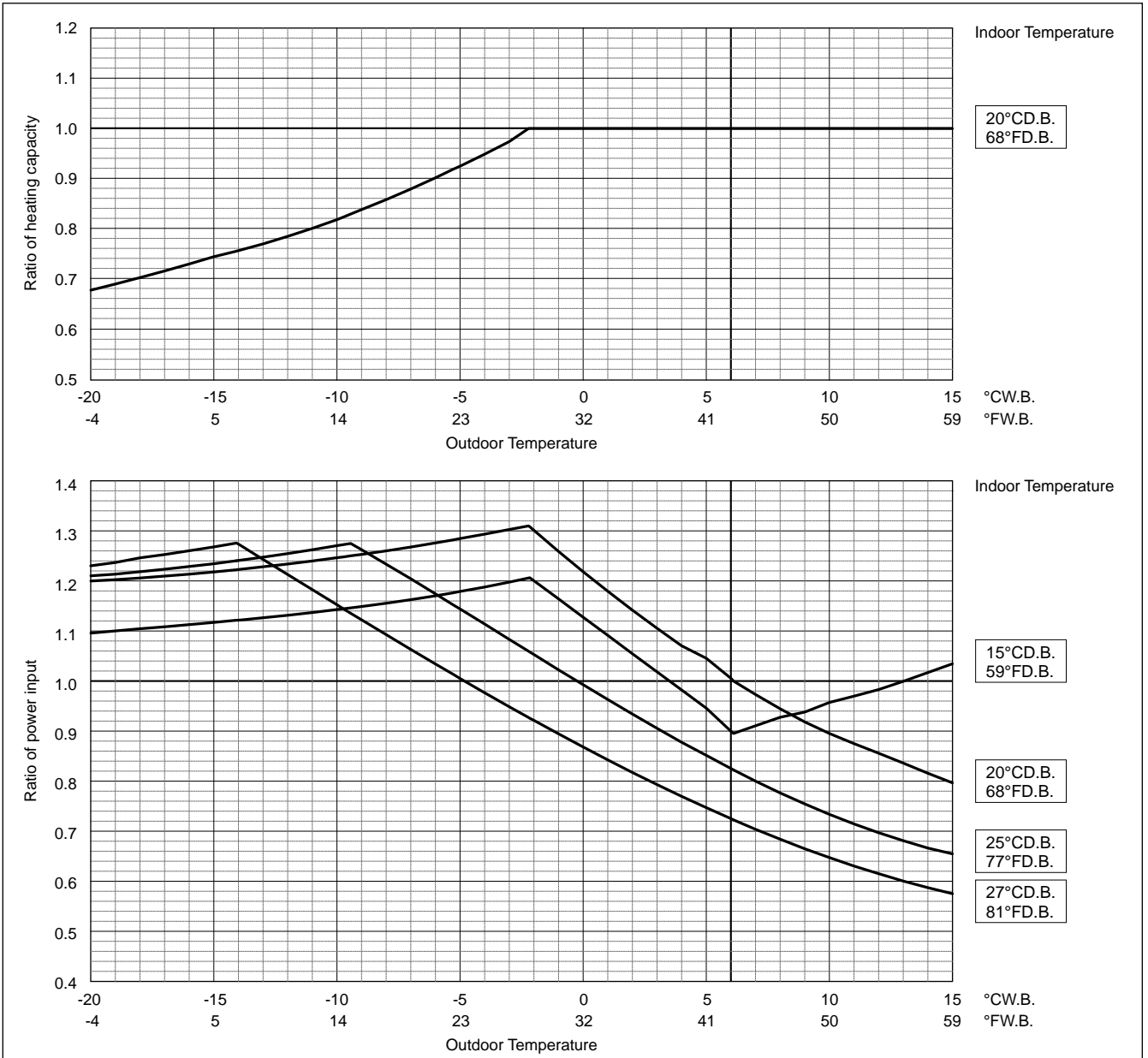

Outdoor unit power input is affected by the indoor and outdoor temperatures as shown in the graph above. Please consult the sales office for details.

2. CAPACITY TABLES

OUTDOOR

PURY-		P300YLM-A1	P350YLM-A1	P400YLM-A1
Nominal Cooling Capacity	kW	33.5	40.0	45.0
	BTU/h	114,300	136,500	153,500
Input	kW	13.34	17.93	16.65

PURY-		EP300YLM-A1	EP350YLM-A1	EP400YLM-A1
Nominal Cooling Capacity	kW	33.5	40.0	45.0
	BTU/h	114,300	136,500	153,500
Input	kW	12.05	17.16	13.88

Indoor unit temperature correction

To be used to correct indoor unit capacity only

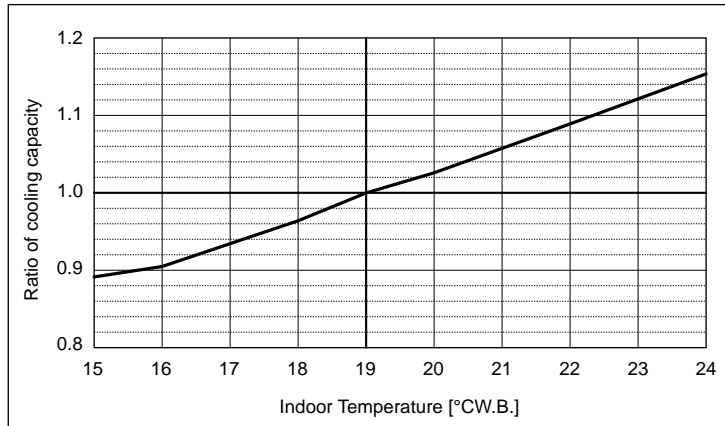

Outdoor unit temperature correction

To be used to correct outdoor unit only

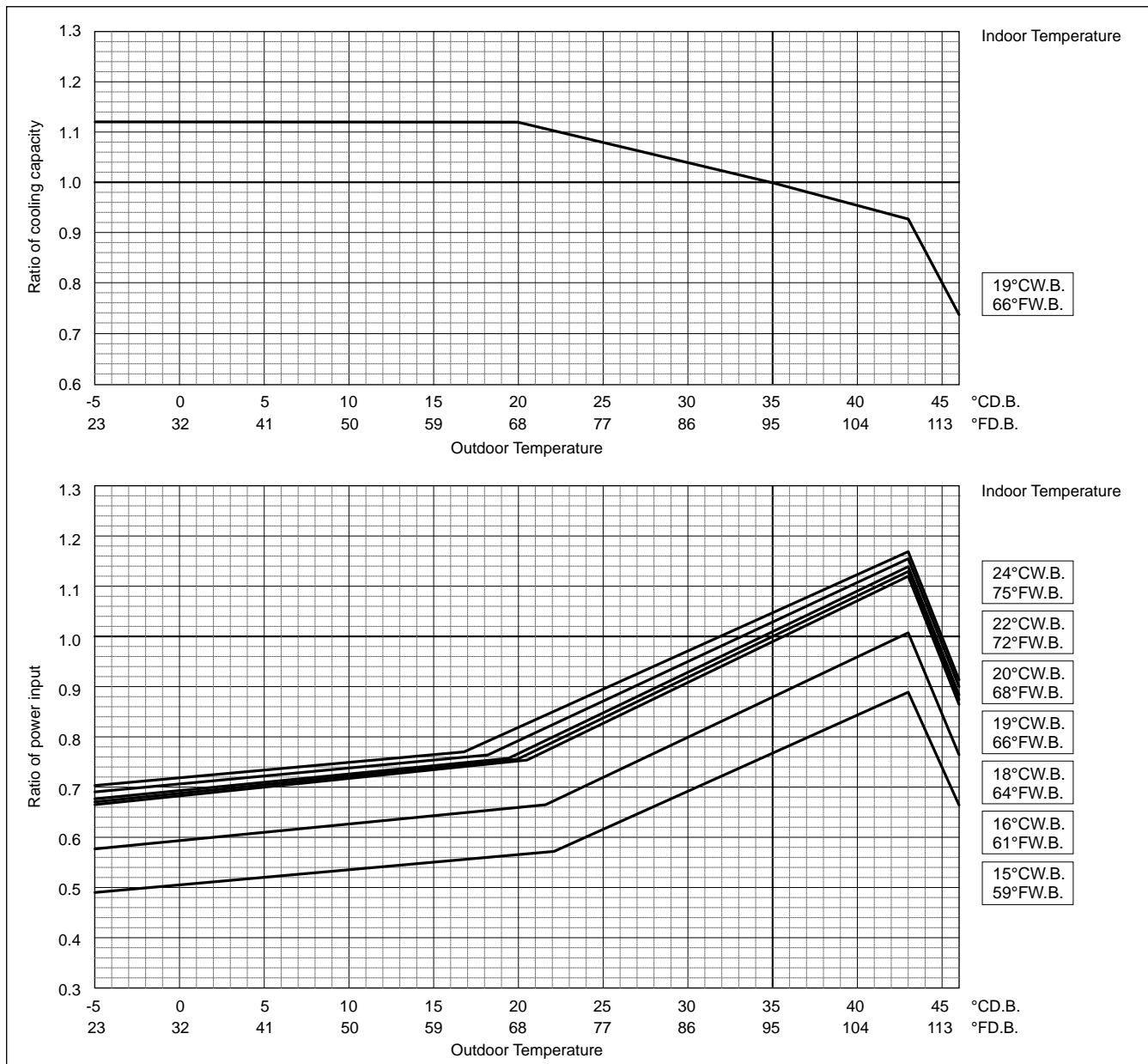

Outdoor unit power input is affected by the indoor and outdoor temperatures as shown in the graph above. Please consult the sales office for details.

2. CAPACITY TABLES

PURY-	P300YLM-A1	P350YLM-A1	P400YLM-A1
Nominal Heating Capacity	kW 37.5	45.0	45.0
	BTU/h 128,000	153,500	153,500
Input	kW 12.71	15.51	13.39

PURY-	EP300YLM-A1	EP350YLM-A1	EP400YLM-A1
Nominal Heating Capacity	kW 37.5	45.0	50.0
	BTU/h 128,000	153,500	170,600
Input	kW 11.71	15.38	14.12

Indoor unit temperature correction

To be used to correct indoor unit capacity only

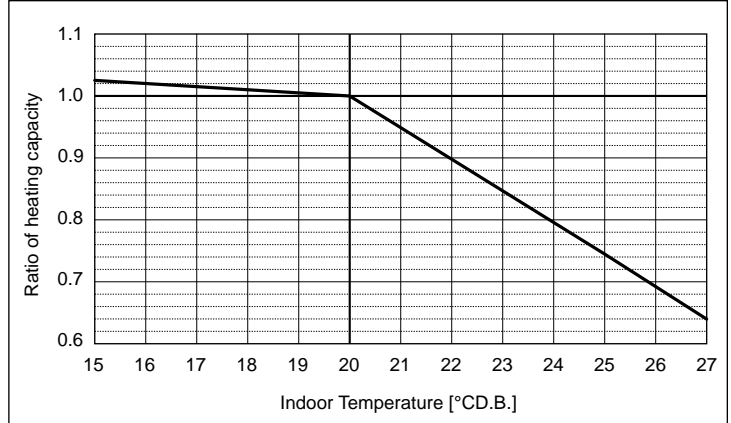

Outdoor unit temperature correction

To be used to correct outdoor unit only

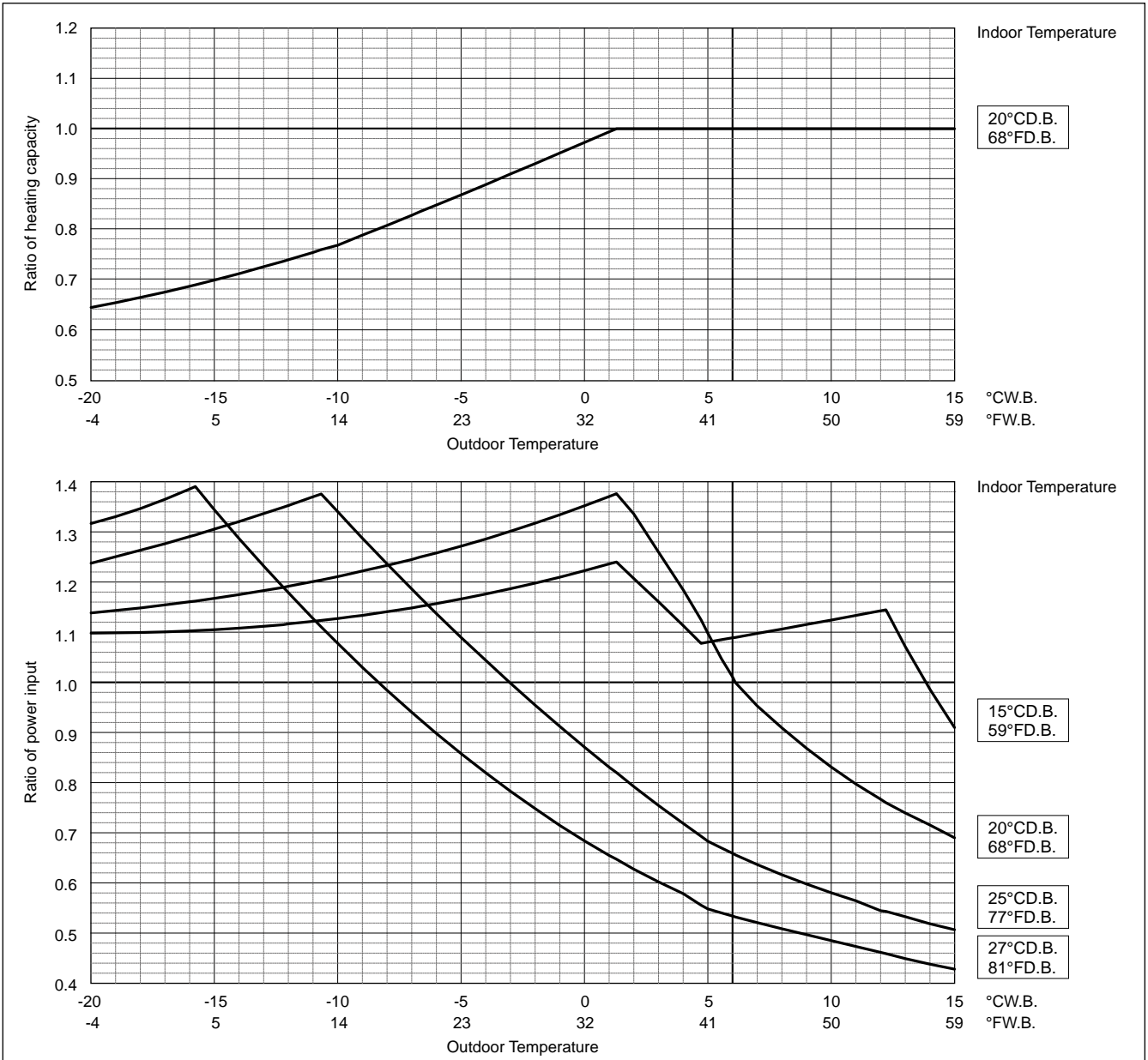

Outdoor unit power input is affected by the indoor and outdoor temperatures as shown in the graph above. Please consult the sales office for details.

2. CAPACITY TABLES

OUTDOOR

PURY-		P450YLM-A1	P500YLM-A1
Nominal Cooling Capacity	kW	50.0	56.0
	BTU/h	170,600	191,100
Input	kW	17.92	22.67

PURY-		EP450YLM-A1	EP500YLM-A1
Nominal Cooling Capacity	kW	50.0	56.0
	BTU/h	170,600	191,100
Input	kW	16.83	21.22

Indoor unit temperature correction

To be used to correct indoor unit capacity only

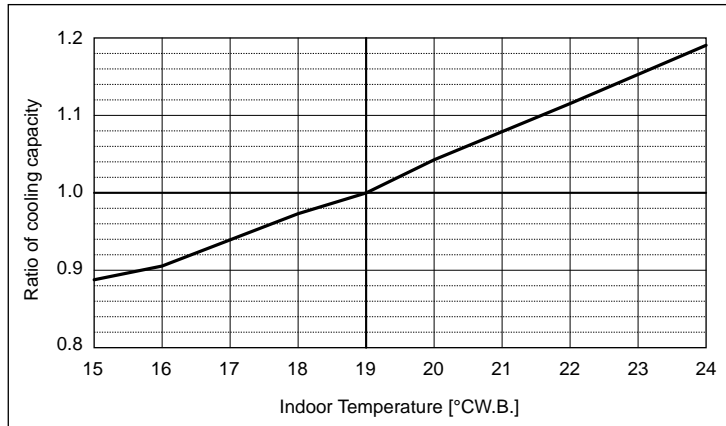

Outdoor unit temperature correction

To be used to correct outdoor unit only

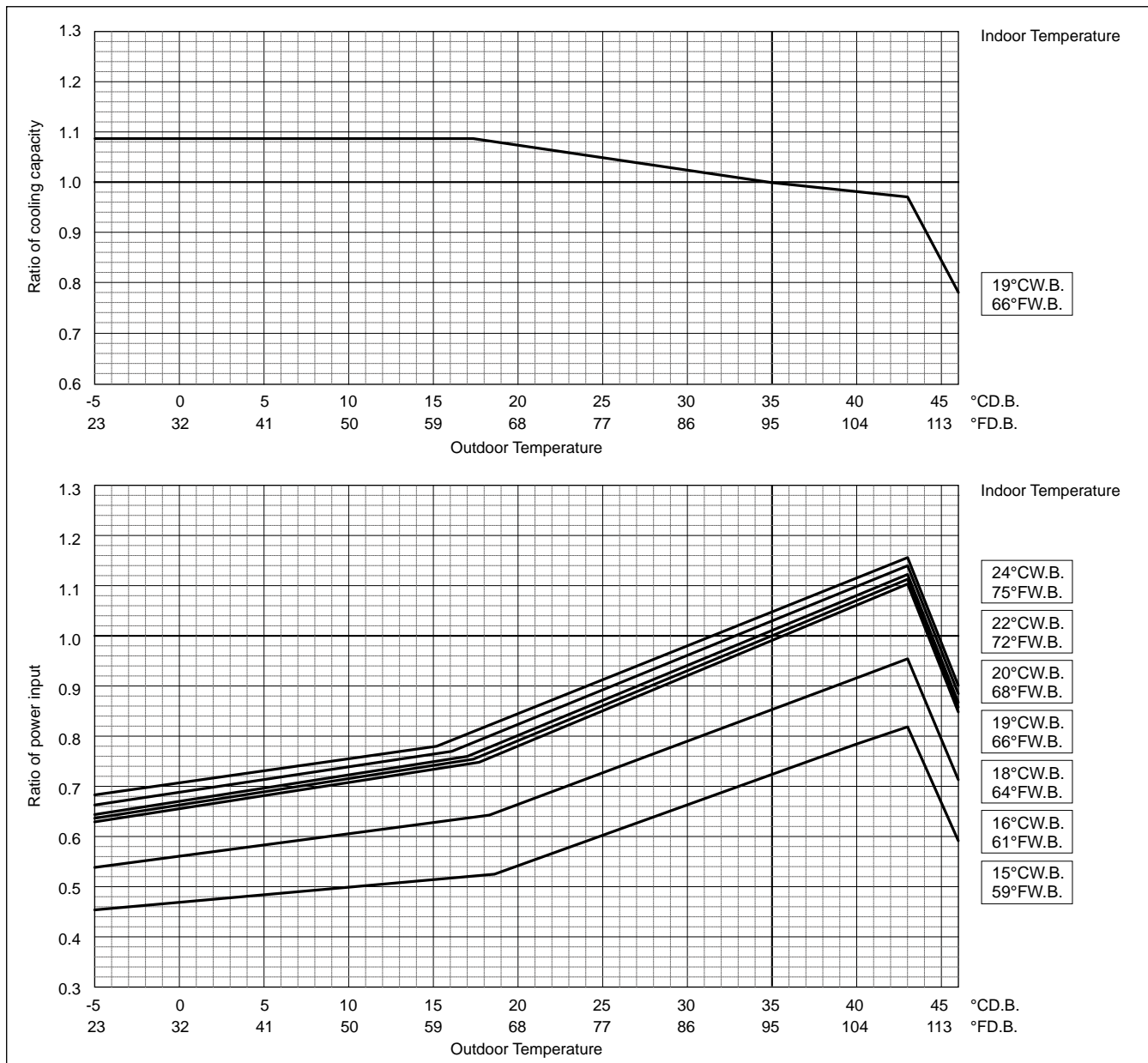

Outdoor unit power input is affected by the indoor and outdoor temperatures as shown in the graph above. Please consult the sales office for details.

2. CAPACITY TABLES

PURY-		P450YLM-A1	P500YLM-A1
Nominal Heating Capacity	kW	56.0	58.0
	BTU/h	191,100	197,900
Input	kW	17.39	17.53

PURY-		EP450YLM-A1	EP500YLM-A1
Nominal Heating Capacity	kW	56.0	63.0
	BTU/h	191,100	215,000
Input	kW	16.86	21.67

Indoor unit temperature correction

To be used to correct indoor unit capacity only

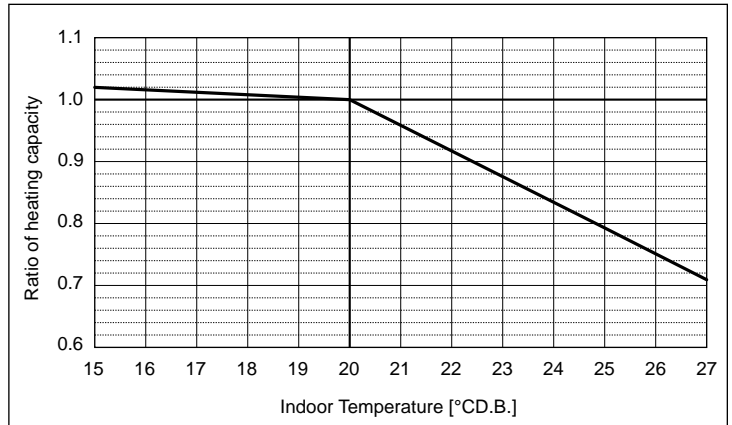

Outdoor unit temperature correction

To be used to correct outdoor unit only

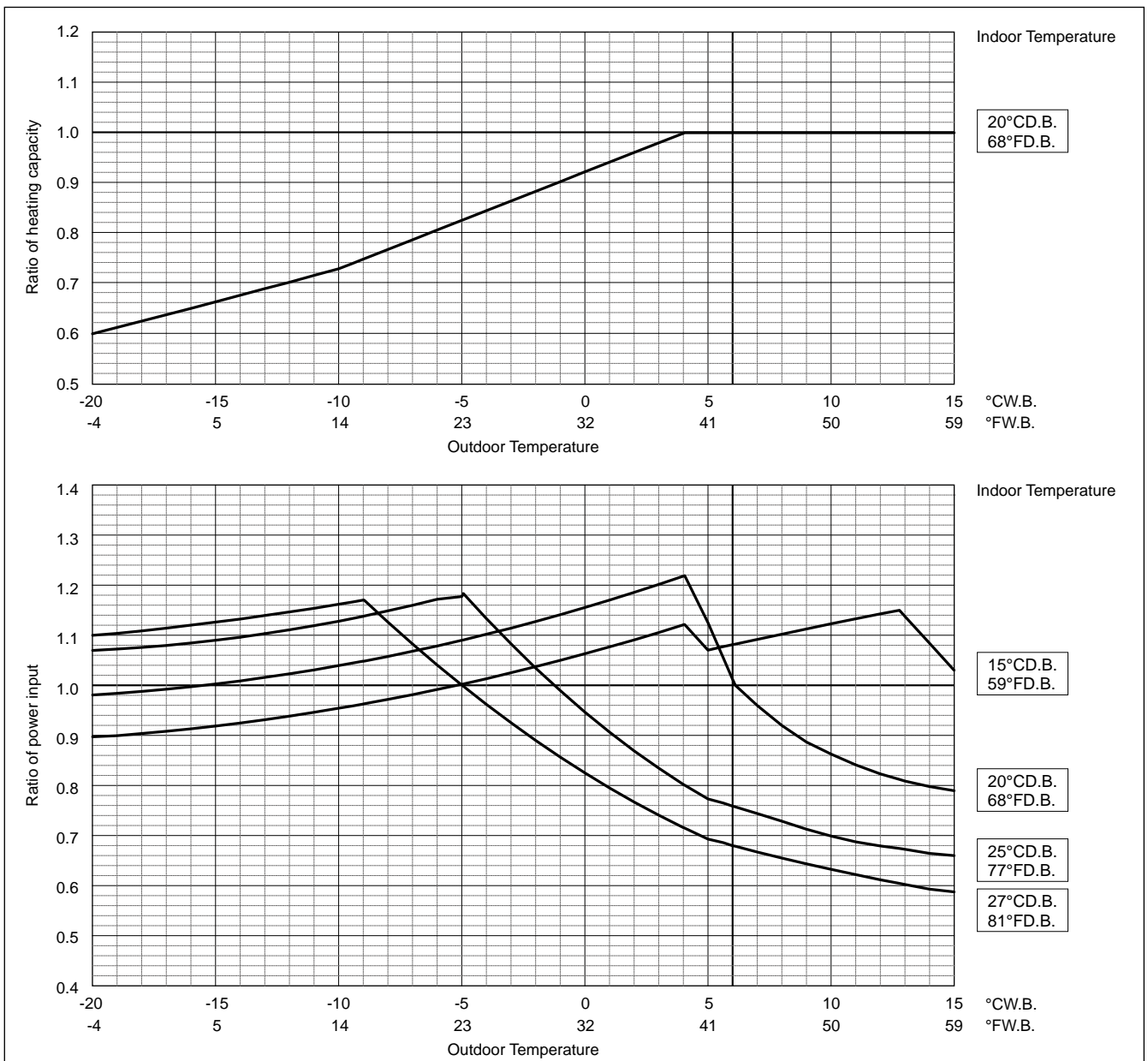

Outdoor unit power input is affected by the indoor and outdoor temperatures as shown in the graph above. Please consult the sales office for details.

2. CAPACITY TABLES

Correction by temperature (COP Priority Mode)

CITY MULTI could have various capacities at different designing temperatures. Using the nominal cooling/heating capacity values and the ratios below, the capacity can be found for various temperatures.

To select COP priority mode, DipSW 3-7 must be set to ON.

PURY-		P200YLM-A1	P250YLM-A1
Nominal Cooling Capacity	kW	22.4	28.0
	BTU/h	76,400	95,500
Input	kW	7.00	9.92

PURY-		EP200YLM-A1	EP250YLM-A1
Nominal Cooling Capacity	kW	22.4	28.0
	BTU/h	76,400	95,500
Input	kW	6.27	8.77

Indoor unit temperature correction

To be used to correct indoor unit capacity only

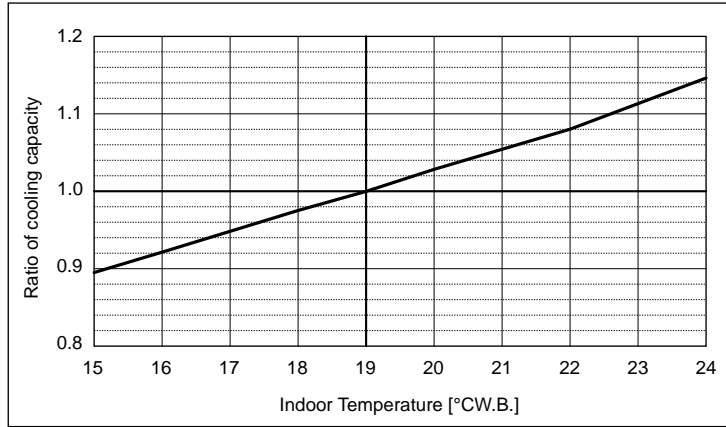

Outdoor unit temperature correction

To be used to correct outdoor unit only

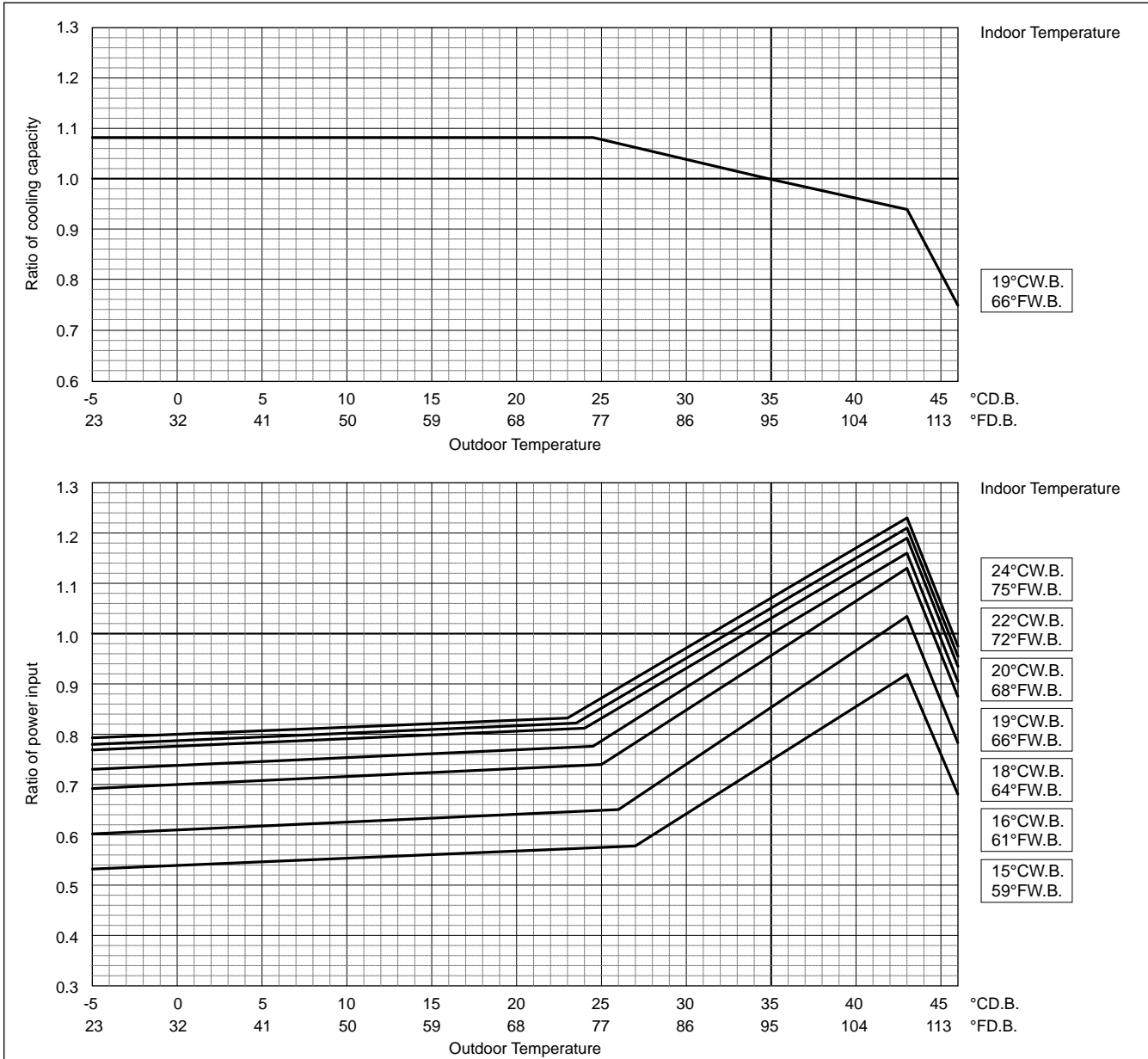

Outdoor unit power input is affected by the indoor and outdoor temperatures as shown in the graph above. Please consult the sales office for details.

2. CAPACITY TABLES

	PURY-	P200YLM-A1	P250YLM-A1
Nominal Heating Capacity	kW	25.0	31.5
	BTU/h	85,300	107,500
Input	kW	7.08	10.06

	PURY-	EP200YLM-A1	EP250YLM-A1
Nominal Heating Capacity	kW	25.0	31.5
	BTU/h	85,300	107,500
Input	kW	6.92	9.84

Indoor unit temperature correction

To be used to correct indoor unit capacity only

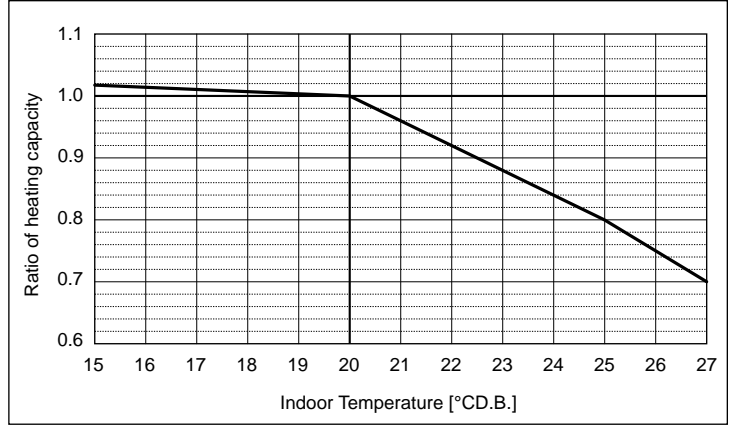

Outdoor unit temperature correction

To be used to correct outdoor unit only

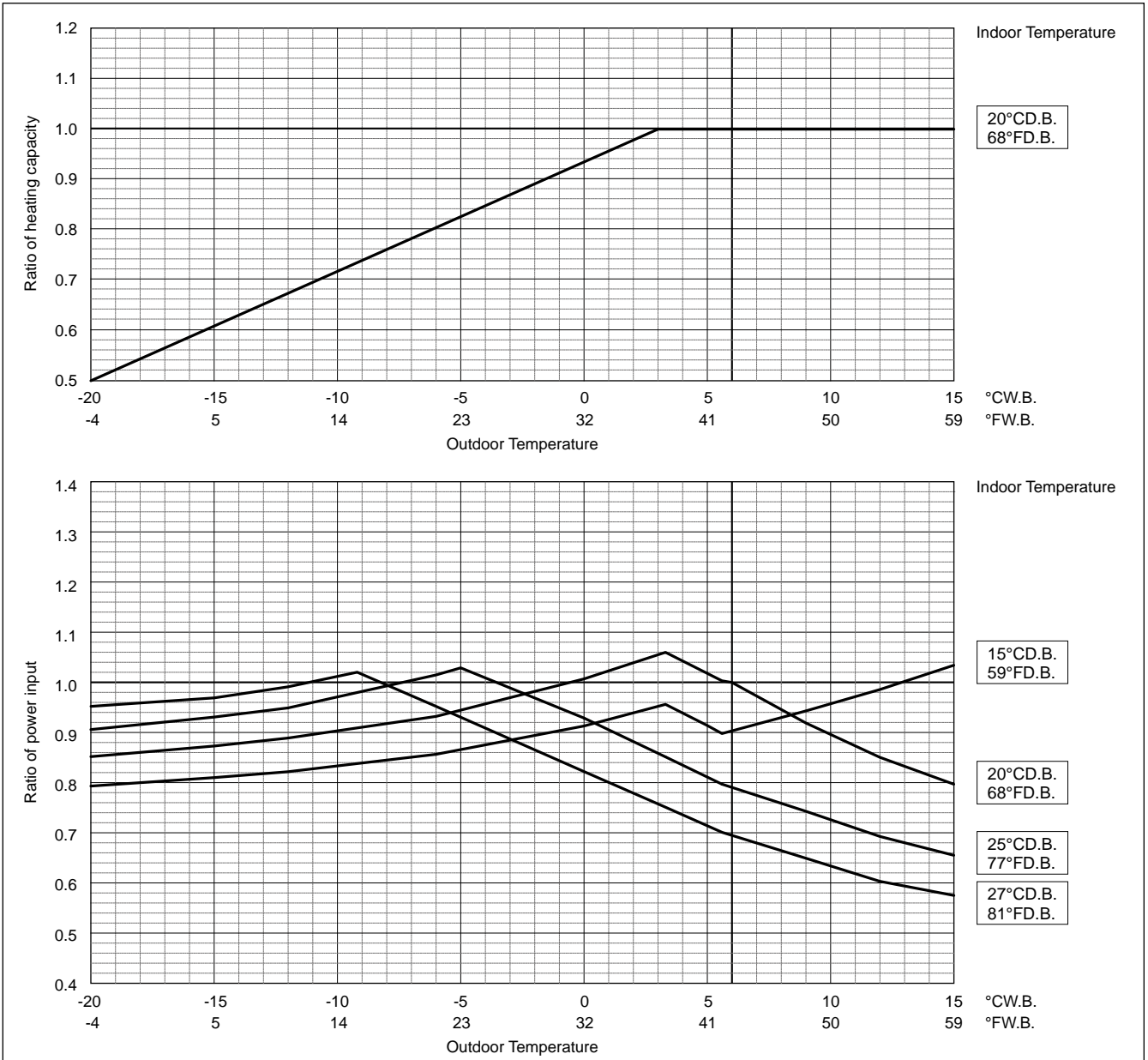

Outdoor unit power input is affected by the indoor and outdoor temperatures as shown in the graph above. Please consult the sales office for details.

2. CAPACITY TABLES

OUTDOOR

PURY-		P300YLM-A1	P350YLM-A1	P400YLM-A1
Nominal Cooling Capacity	kW	33.5	40.0	45.0
	BTU/h	114,300	136,500	153,500
Input	kW	13.34	17.93	16.65

PURY-		EP300YLM-A1	EP350YLM-A1	EP400YLM-A1
Nominal Cooling Capacity	kW	33.5	40.0	45.0
	BTU/h	114,300	136,500	153,500
Input	kW	12.05	17.16	13.88

Indoor unit temperature correction

To be used to correct indoor unit capacity only

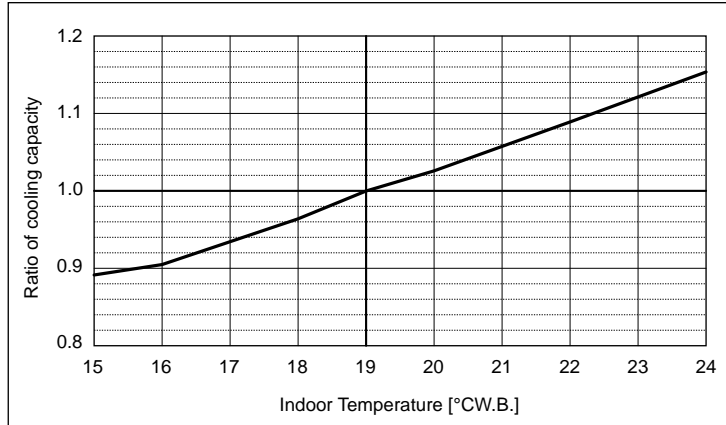

Outdoor unit temperature correction

To be used to correct outdoor unit only

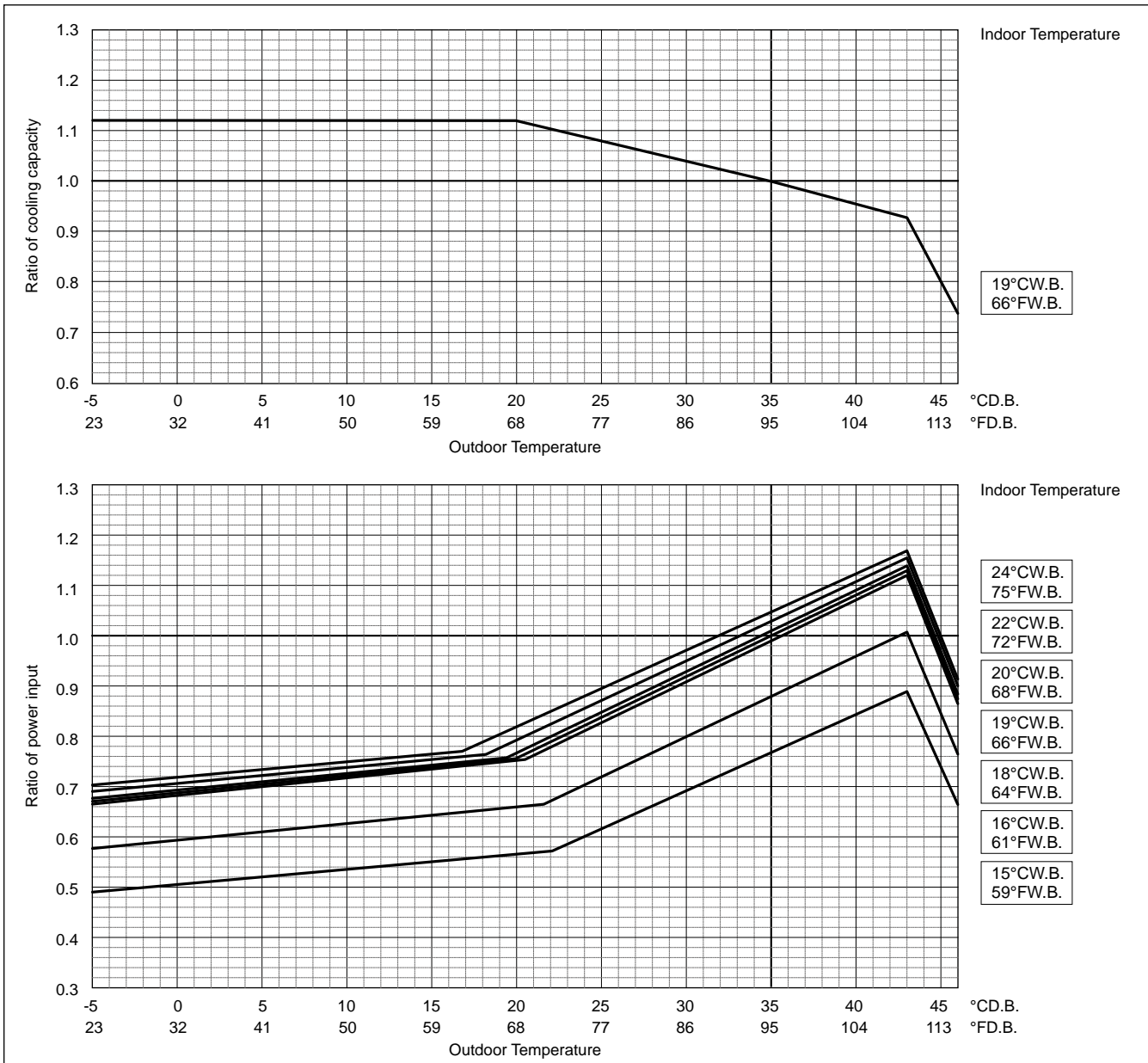

Outdoor unit power input is affected by the indoor and outdoor temperatures as shown in the graph above. Please consult the sales office for details.

2. CAPACITY TABLES

PURY-	P300YLM-A1	P350YLM-A1	P400YLM-A1
Nominal Heating Capacity	kW 37.5	45.0	45.0
	BTU/h 128,000	153,500	153,500
Input	kW 12.71	15.51	13.39

PURY-	EP300YLM-A1	EP350YLM-A1	EP400YLM-A1
Nominal Heating Capacity	kW 37.5	45.0	50.0
	BTU/h 128,000	153,500	170,600
Input	kW 11.71	15.38	14.12

Indoor unit temperature correction

To be used to correct indoor unit capacity only

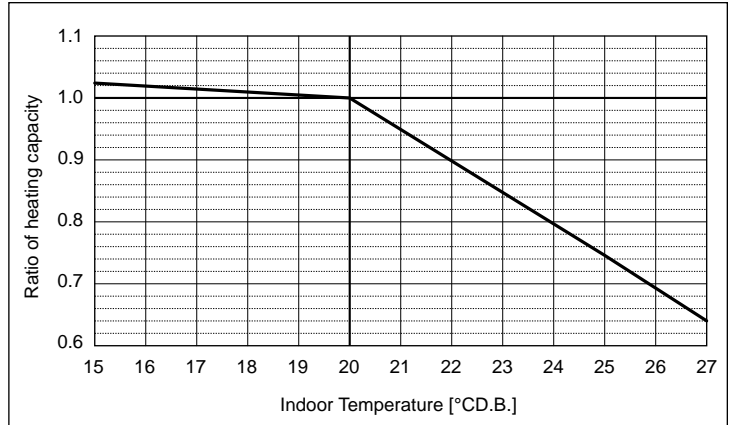

Outdoor unit temperature correction

To be used to correct outdoor unit only

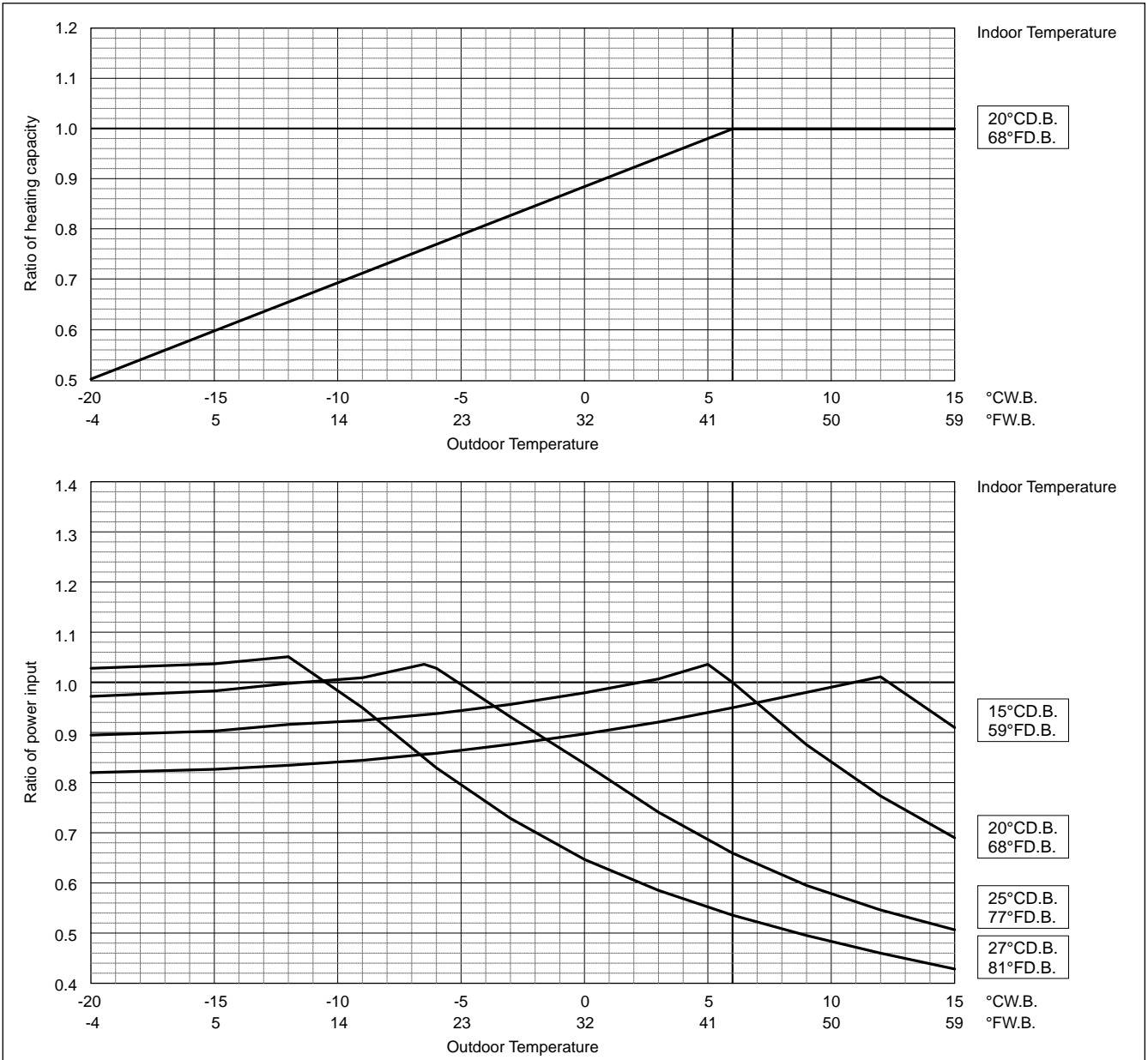

Outdoor unit power input is affected by the indoor and outdoor temperatures as shown in the graph above. Please consult the sales office for details.

2. CAPACITY TABLES

OUTDOOR

PURY-		P450YLM-A1	P500YLM-A1
Nominal Cooling Capacity	kW	50.0	56.0
	BTU/h	170,600	191,100
Input	kW	17.92	22.67

PURY-		EP450YLM-A1	EP500YLM-A1
Nominal Cooling Capacity	kW	50.0	56.0
	BTU/h	170,600	191,100
Input	kW	16.83	21.22

Indoor unit temperature correction

To be used to correct indoor unit capacity only

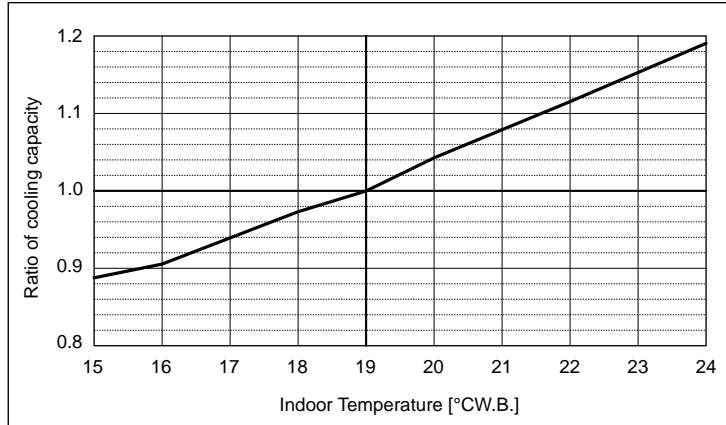

Outdoor unit temperature correction

To be used to correct outdoor unit only

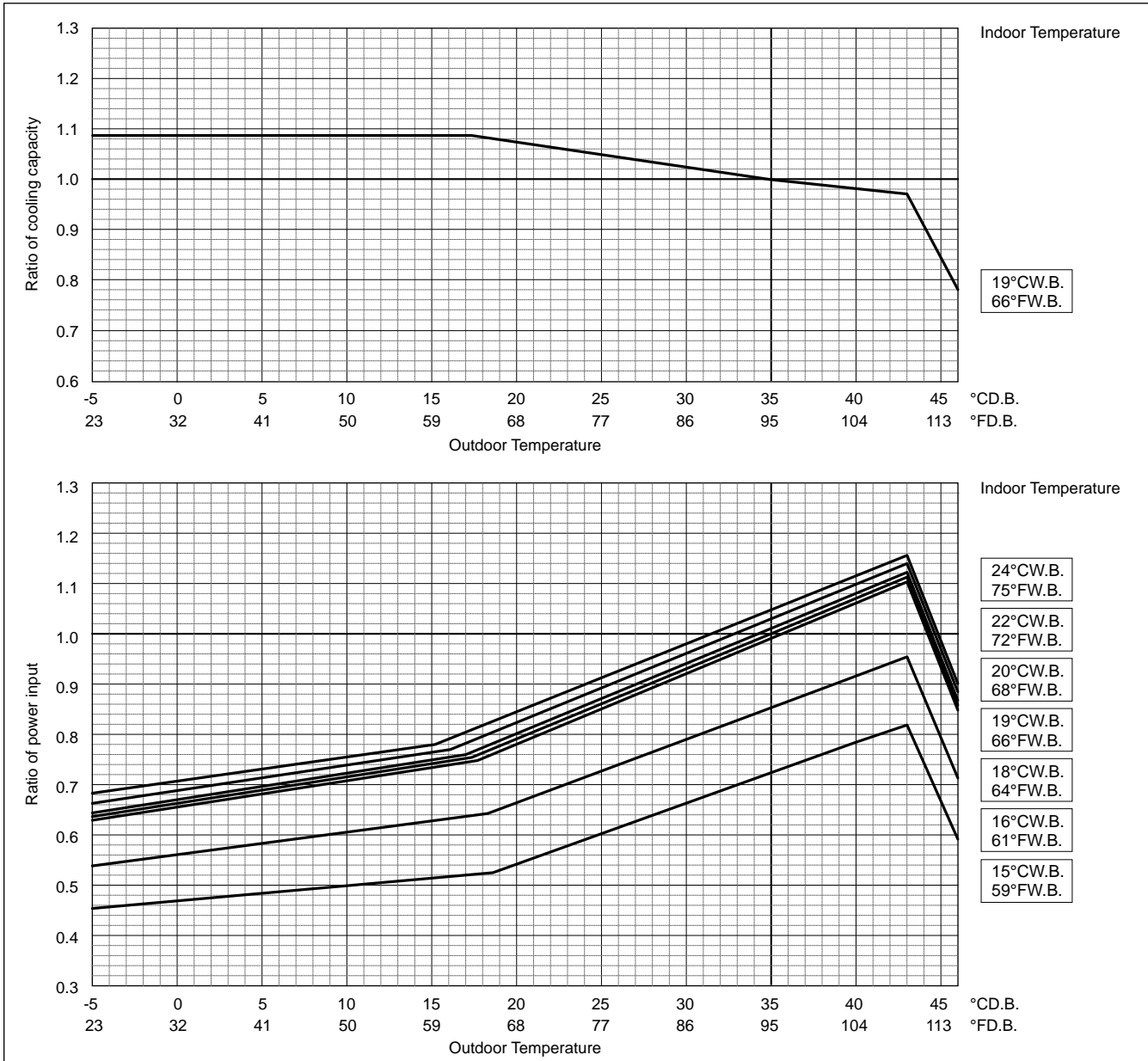

Outdoor unit power input is affected by the indoor and outdoor temperatures as shown in the graph above. Please consult the sales office for details.

2. CAPACITY TABLES

PURY-		P450YLM-A1	P500YLM-A1
Nominal Heating Capacity	kW	56.0	58.0
	BTU/h	191,100	197,900
Input	kW	17.39	17.53

PURY-		EP450YLM-A1	EP500YLM-A1
Nominal Heating Capacity	kW	56.0	63.0
	BTU/h	191,100	215,000
Input	kW	16.86	21.67

Indoor unit temperature correction

To be used to correct indoor unit capacity only

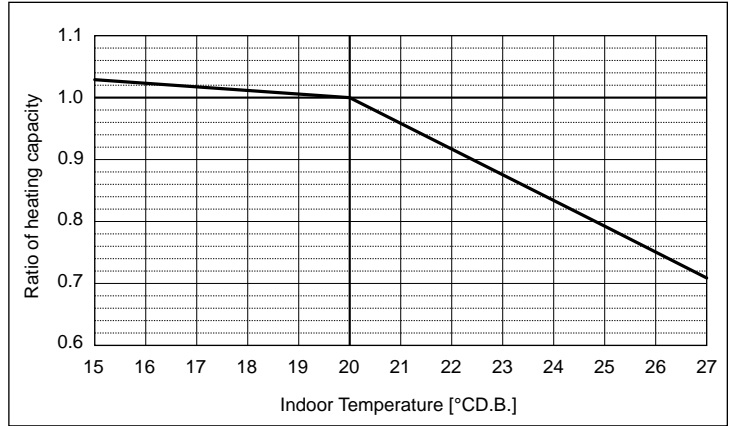

Outdoor unit temperature correction

To be used to correct outdoor unit only

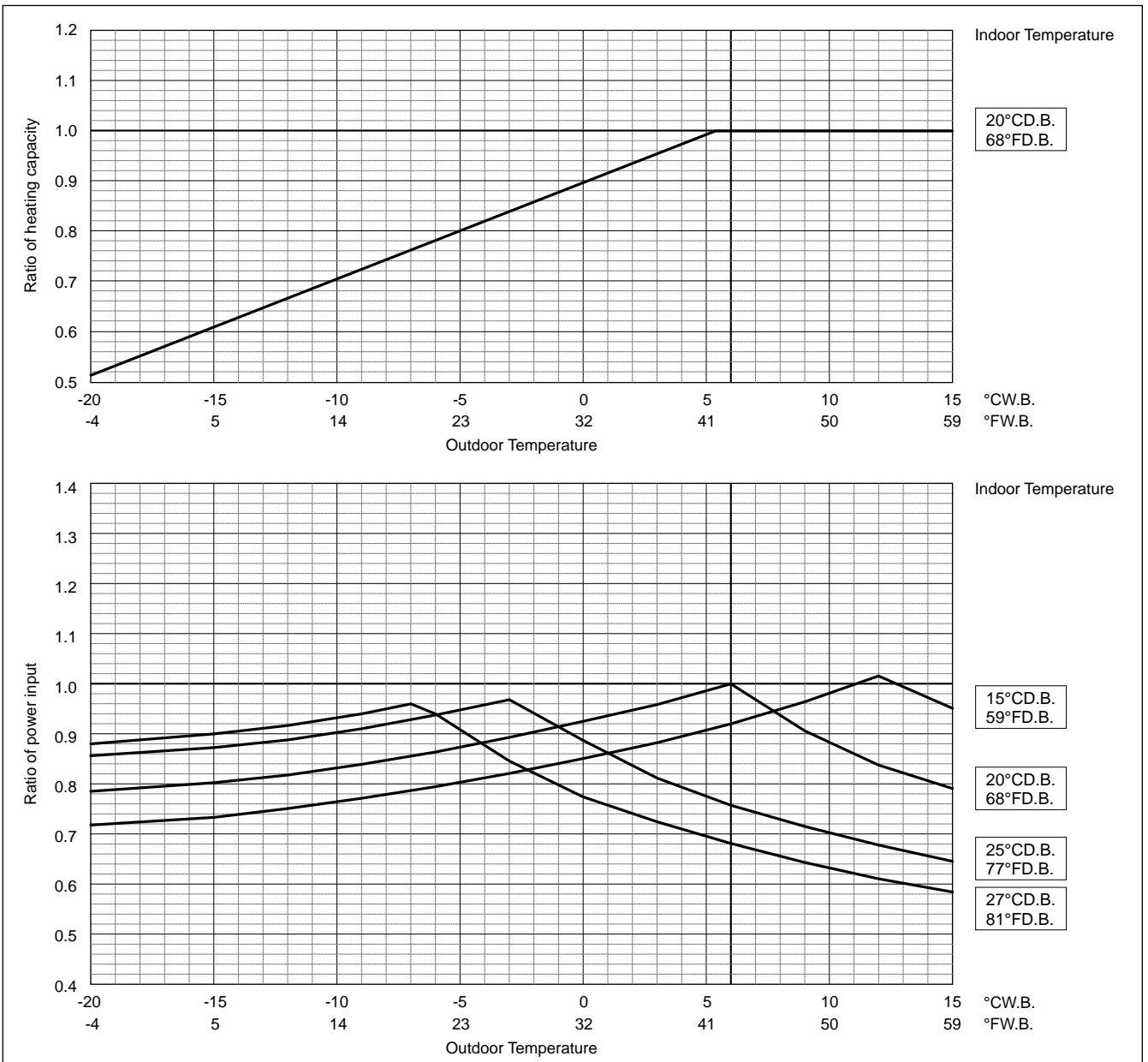

Outdoor unit power input is affected by the indoor and outdoor temperatures as shown in the graph above. Please consult the sales office for details.

2. CAPACITY TABLES

OUTDOOR

2-2. Correction by total indoor

CITY MULTI system have different capacities and inputs when many combinations of indoor units with different total capacities are connected. Using following tables, the maximum capacity can be found to ensure the system is installed with enough capacity for a particular application.

PURY-P200YLM-A1		
Nominal Cooling Capacity	kW	22.4
	BTU/h	76,400
Input	kW	7.00

PURY-P200YLM-A1		
Nominal Heating Capacity	kW	25.0
	BTU/h	85,300
Input	kW	7.08

PURY-EP200YLM-A1		
Nominal Cooling Capacity	kW	22.4
	BTU/h	76,400
Input	kW	6.27

PURY-EP200YLM-A1		
Nominal Heating Capacity	kW	25.0
	BTU/h	85,300
Input	kW	6.92

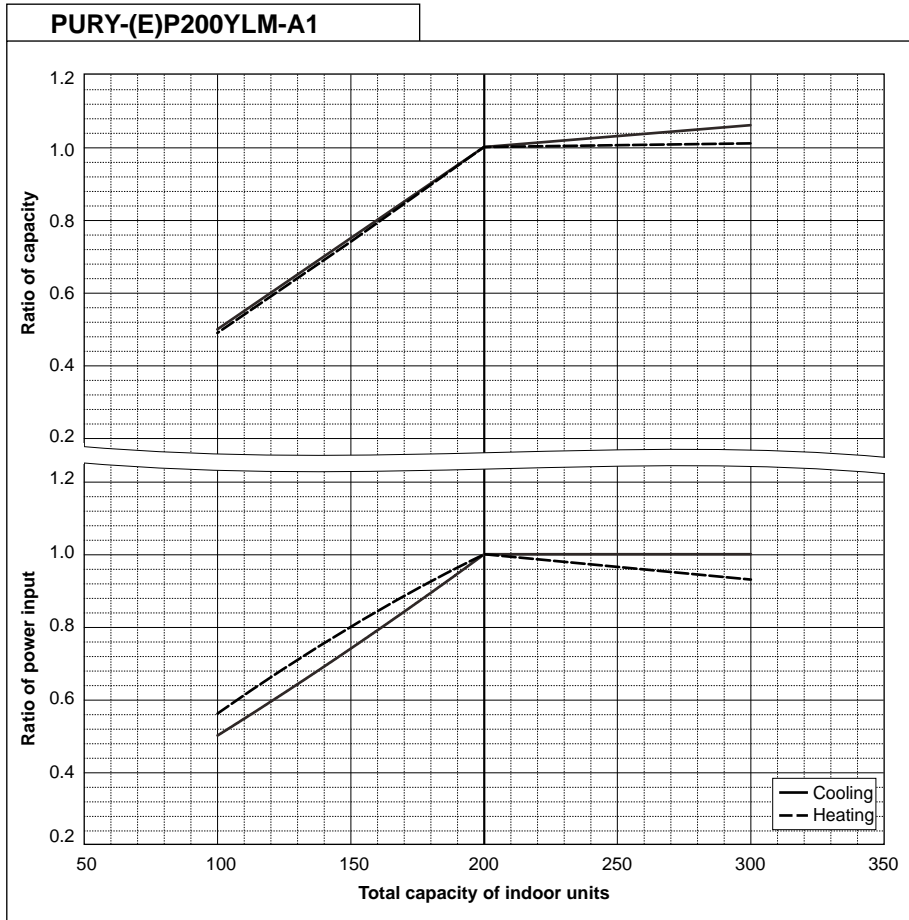

PURY-P250YLM-A1		
Nominal Cooling Capacity	kW	28.0
	BTU/h	95,500
Input	kW	9.92

PURY-P250YLM-A1		
Nominal Heating Capacity	kW	31.5
	BTU/h	107,500
Input	kW	8.77

PURY-EP250YLM-A1		
Nominal Cooling Capacity	kW	28.0
	BTU/h	95,500
Input	kW	10.06

PURY-EP250YLM-A1		
Nominal Heating Capacity	kW	31.5
	BTU/h	107,500
Input	kW	9.84

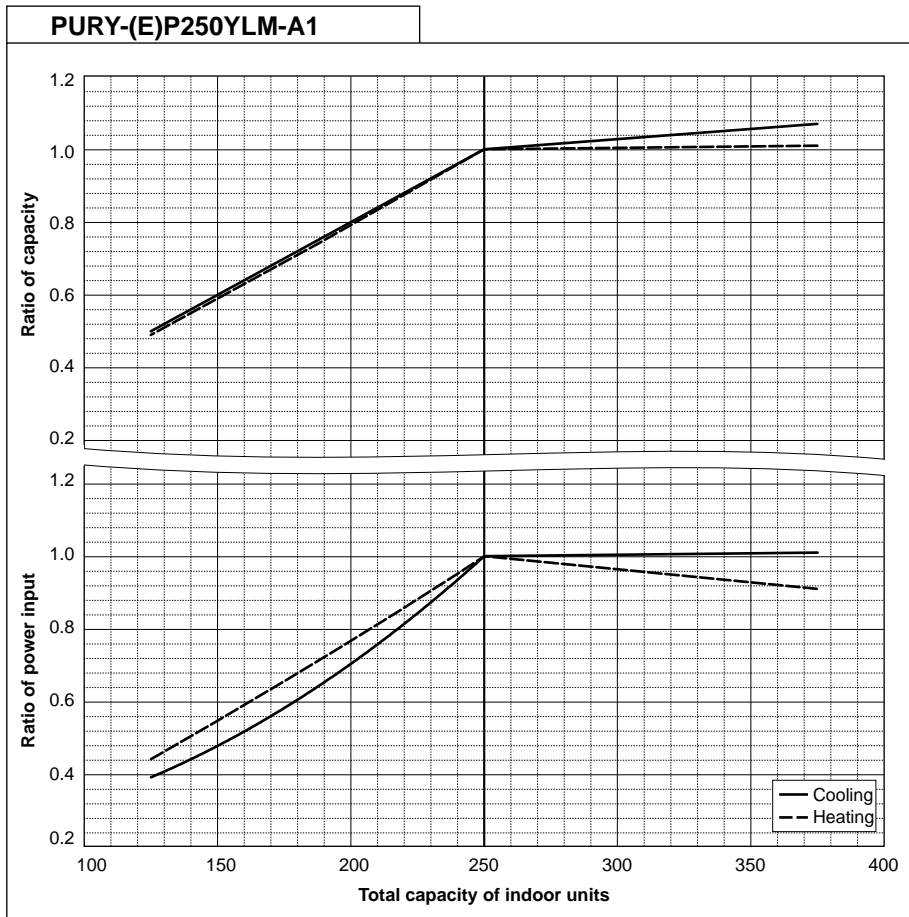

2. CAPACITY TABLES

PURY-P300YLM-A1		
Nominal Cooling Capacity	kW	33.5
	BTU/h	114,300
Input	kW	13.34

PURY-P300YLM-A1		
Nominal Heating Capacity	kW	37.5
	BTU/h	128,000
Input	kW	12.71

PURY-EP300YLM-A1		
Nominal Cooling Capacity	kW	33.5
	BTU/h	114,300
Input	kW	12.05

PURY-EP300YLM-A1		
Nominal Heating Capacity	kW	37.5
	BTU/h	128,000
Input	kW	11.71

PURY-(E)P300YLM-A1

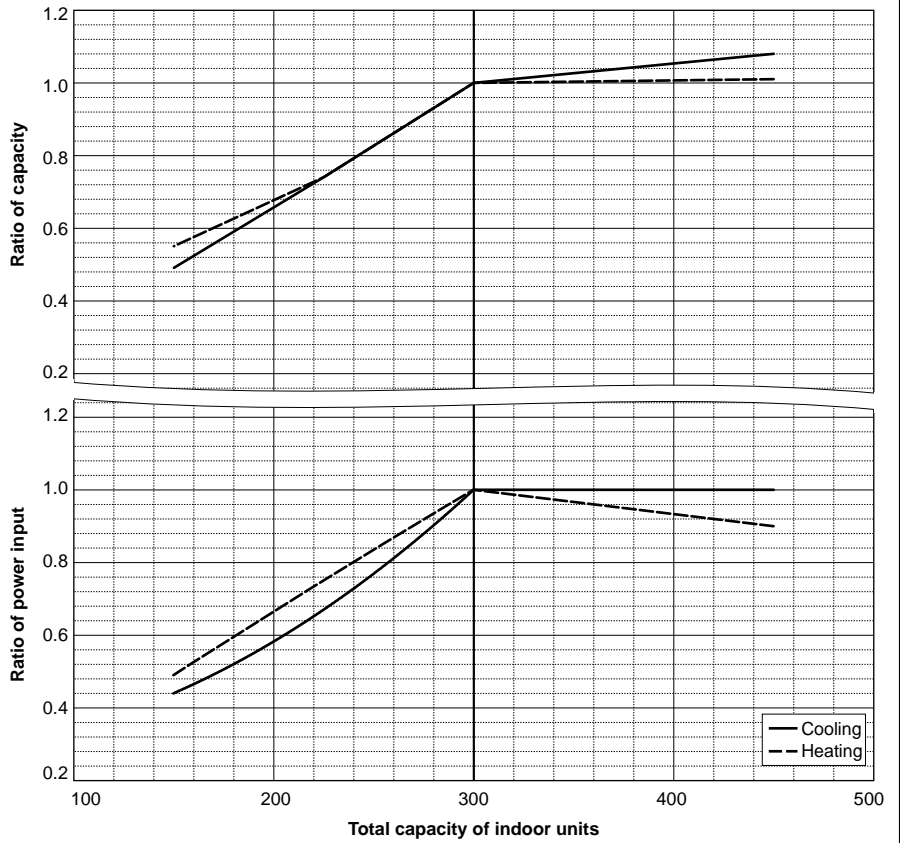

PURY-P350YLM-A1		
Nominal Cooling Capacity	kW	40.0
	BTU/h	136,500
Input	kW	17.93

PURY-P350YLM-A1		
Nominal Heating Capacity	kW	45.0
	BTU/h	153,500
Input	kW	15.51

PURY-EP350YLM-A1		
Nominal Cooling Capacity	kW	40.0
	BTU/h	136,500
Input	kW	17.16

PURY-EP350YLM-A1		
Nominal Heating Capacity	kW	45.0
	BTU/h	153,500
Input	kW	15.38

PURY-(E)P350YLM-A1

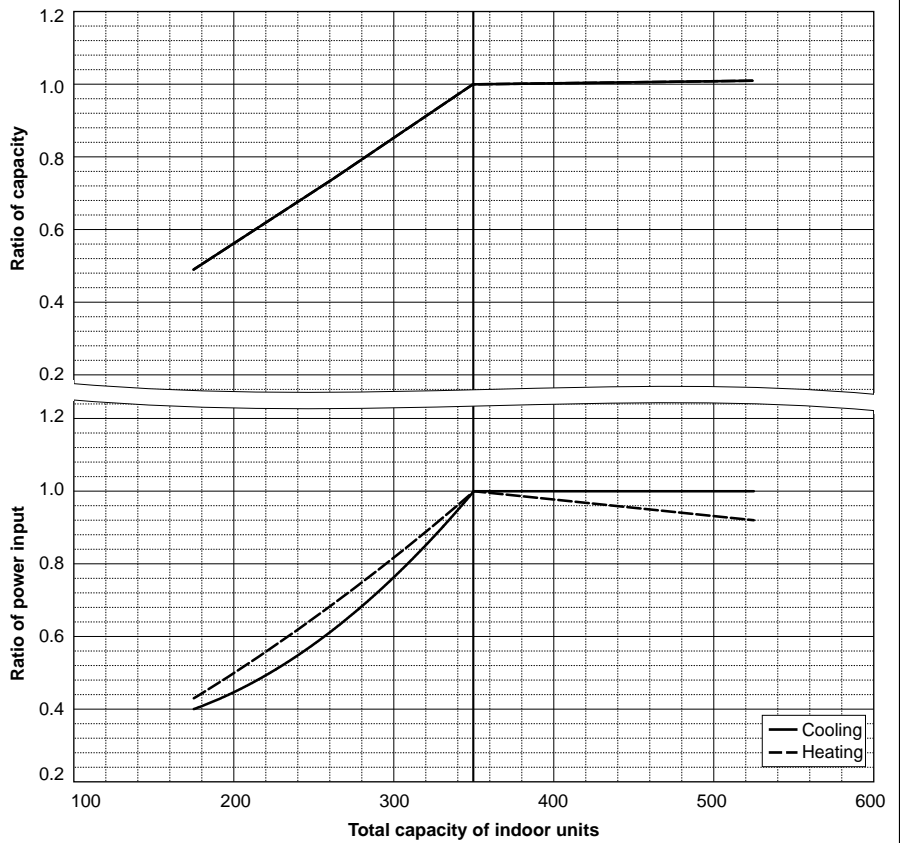

2. CAPACITY TABLES

OUTDOOR

PURY-P400YLM-A1		
Nominal Cooling Capacity	kW	45.0
	BTU/h	153,500
Input	kW	16.65

PURY-P400YLM-A1		
Nominal Heating Capacity	kW	45.0
	BTU/h	153,500
Input	kW	13.39

PURY-EP400YLM-A1		
Nominal Cooling Capacity	kW	45.0
	BTU/h	153,500
Input	kW	13.88

PURY-EP400YLM-A1		
Nominal Heating Capacity	kW	50.0
	BTU/h	170,600
Input	kW	14.12

PURY-P450YLM-A1		
Nominal Cooling Capacity	kW	50.0
	BTU/h	170,600
Input	kW	17.92

PURY-P450YLM-A1		
Nominal Heating Capacity	kW	56.0
	BTU/h	191,100
Input	kW	17.39

PURY-EP450YLM-A1		
Nominal Cooling Capacity	kW	50.0
	BTU/h	170,600
Input	kW	16.83

PURY-EP450YLM-A1		
Nominal Heating Capacity	kW	56.0
	BTU/h	191,100
Input	kW	16.86

PURY-(E)P400YLM-A1

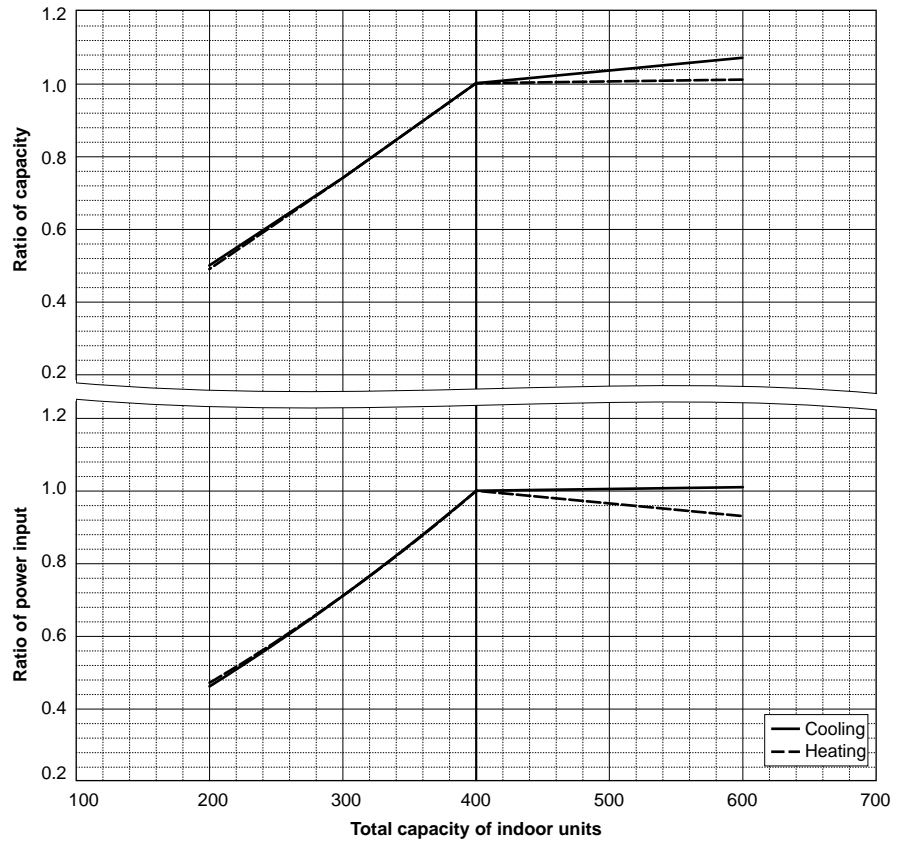

PURY-(E)P450YLM-A1

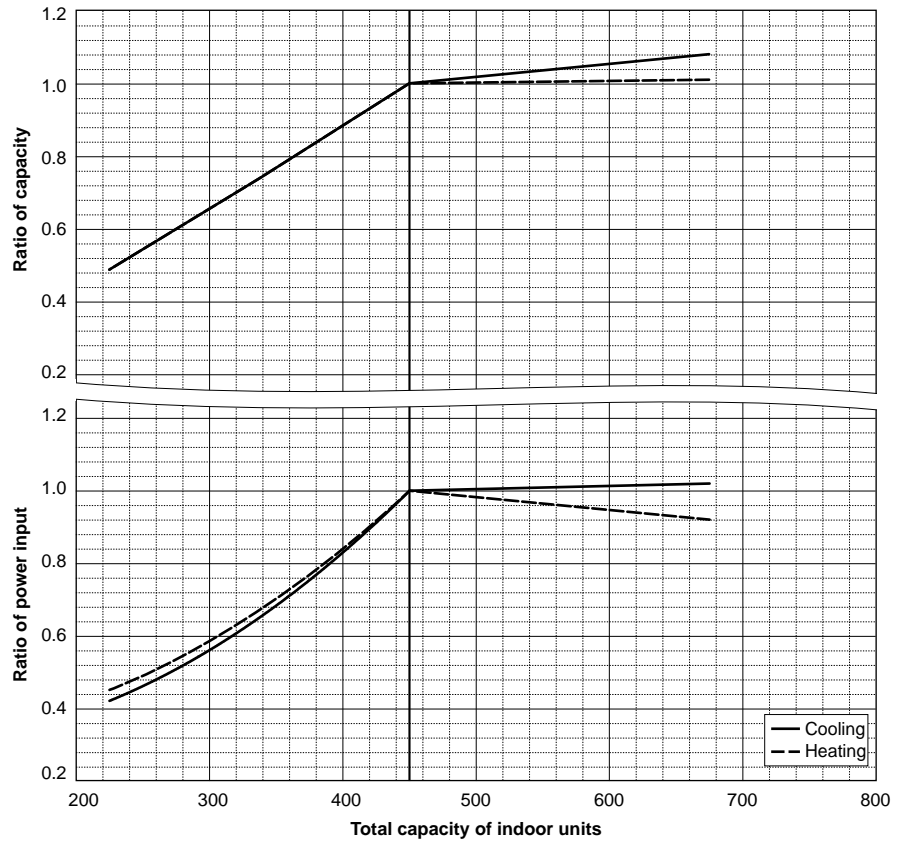

2. CAPACITY TABLES

PURY-P500YLM-A1		
Nominal Cooling Capacity	kW	56.0
	BTU/h	191,100
Input	kW	22.67

PURY-P500YLM-A1		
Nominal Heating Capacity	kW	58.0
	BTU/h	197,900
Input	kW	17.53

PURY-EP500YLM-A1		
Nominal Cooling Capacity	kW	56.0
	BTU/h	191,100
Input	kW	21.22

PURY-EP500YLM-A1		
Nominal Heating Capacity	kW	63.0
	BTU/h	215,000
Input	kW	21.67

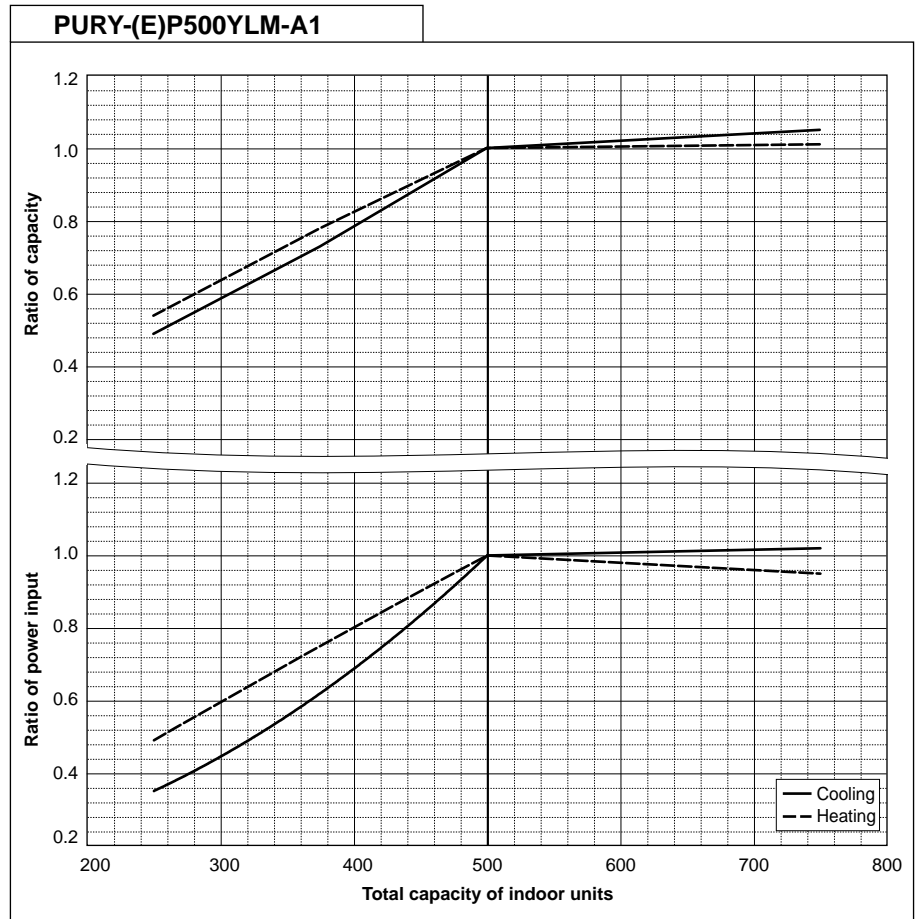

2. CAPACITY TABLES

OUTDOOR

2-3. Correction by piping length

A decrease in cooling/heating capacity will occur due to piping length increase. Using the following correction factors according to the equivalent length of the piping shown at 2-3-1 and 2-3-2 the capacity can be calculated. 2-3-3 shows how to obtain the equivalent length of piping. Refrigerant piping and water piping have separate correction factors.

2-3-1. Cooling capacity correction

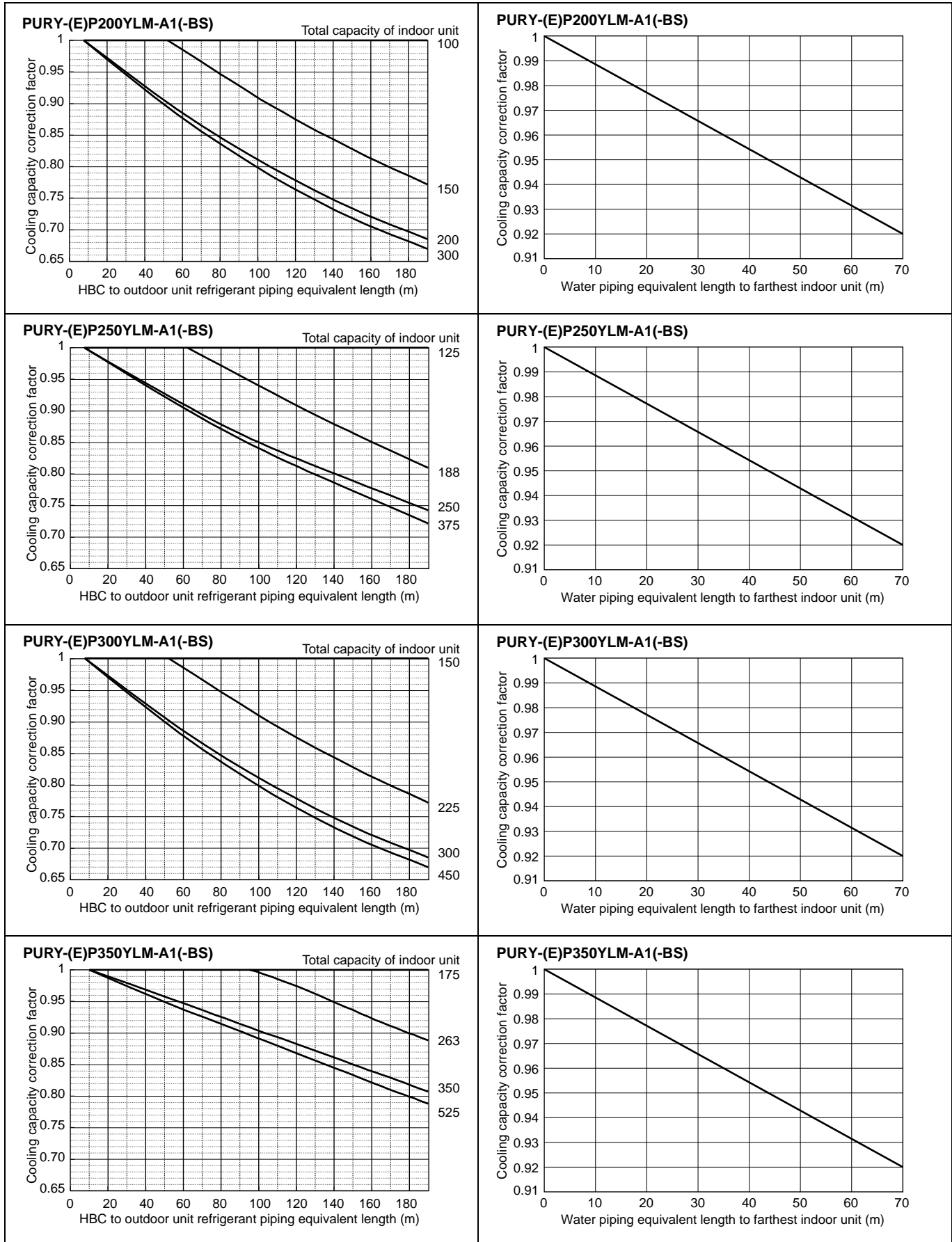

2. CAPACITY TABLES

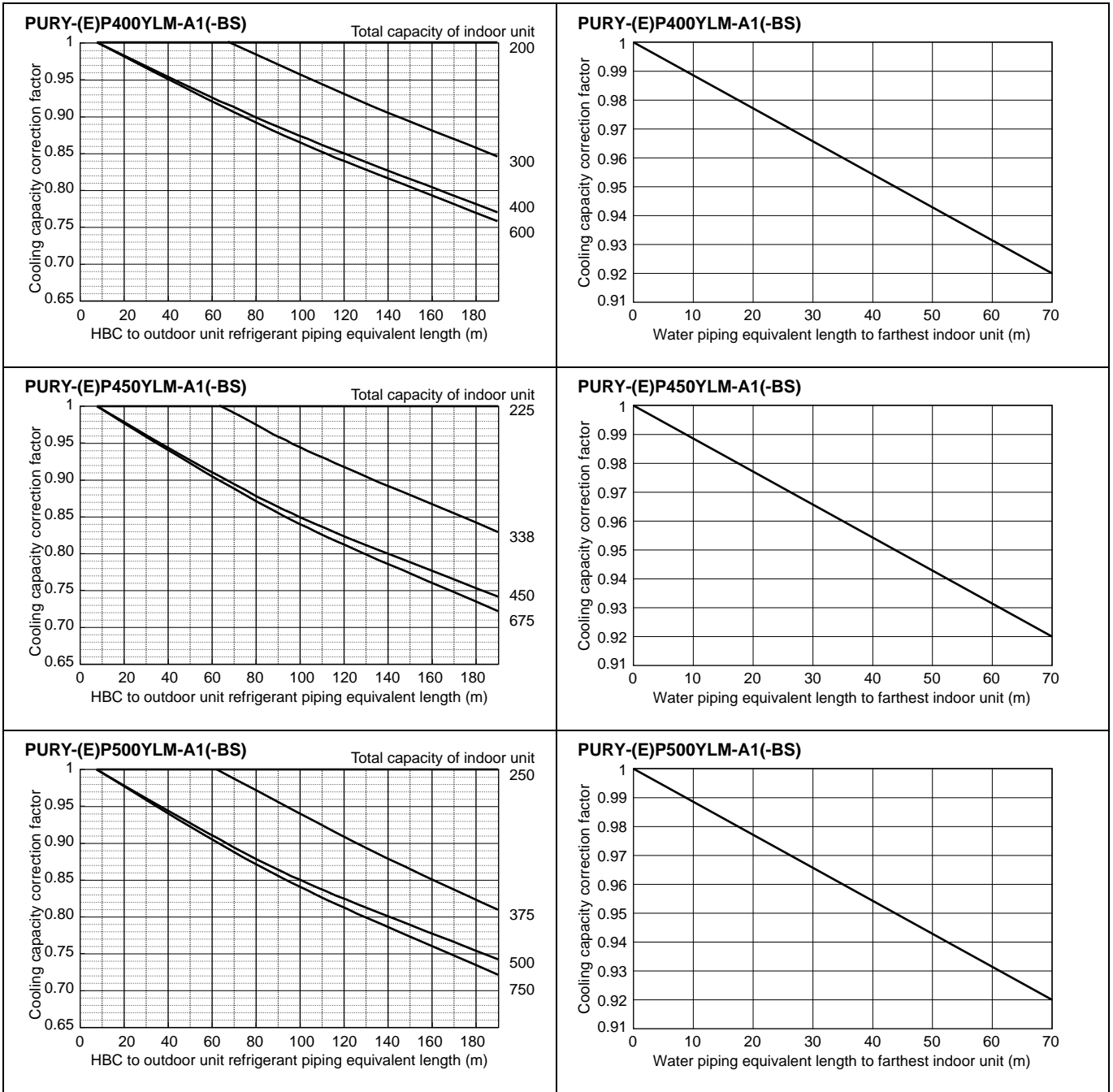

2. CAPACITY TABLES

OUTDOOR

2-3-2. Heating capacity correction

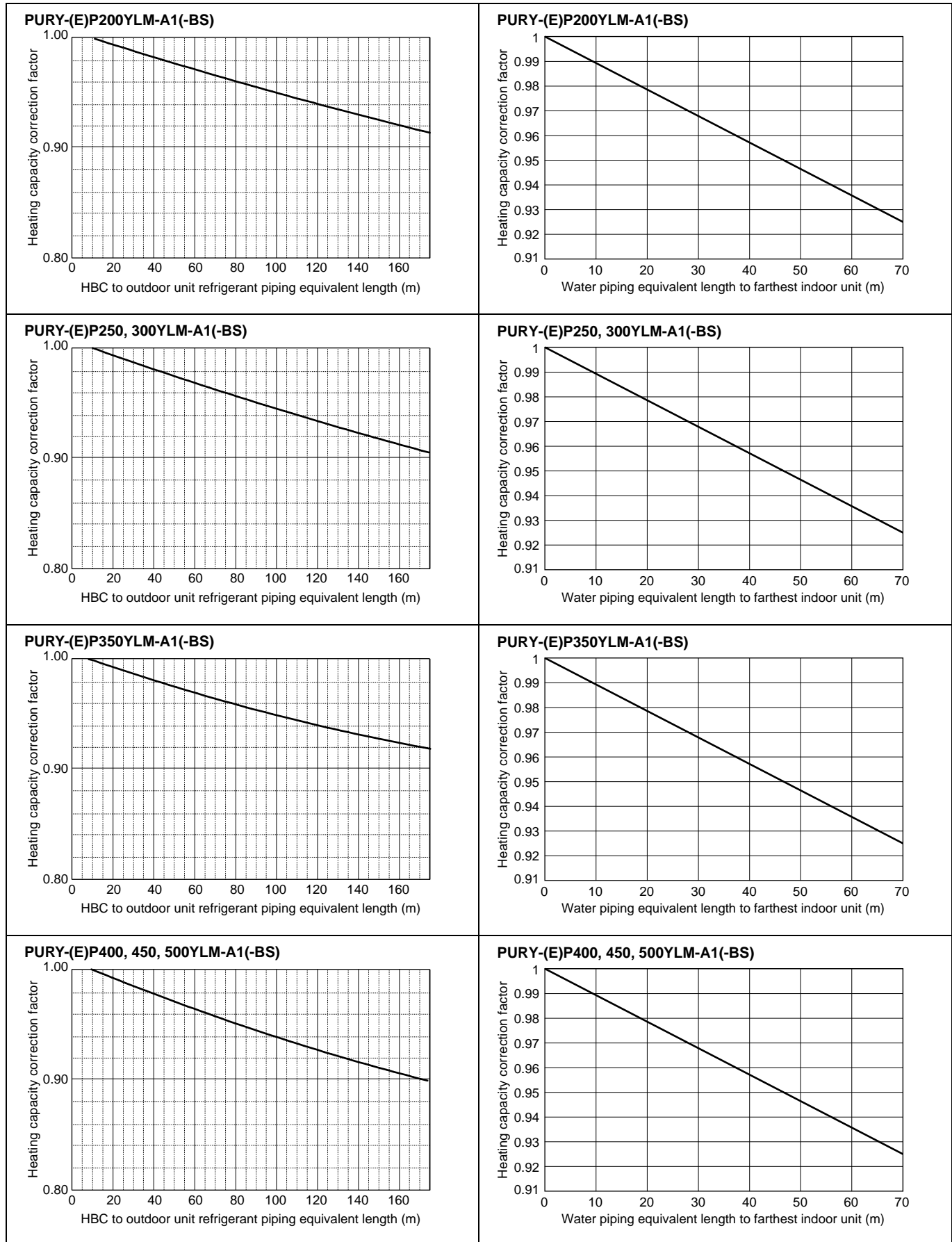

2. CAPACITY TABLES

2-3-3. How to obtain the equivalent piping length

Refrigerant pipe

1. PURY-(E)P200YLM-A1(-BS)

Equivalent length = (Actual piping length to the farthest indoor unit) + (0.35 × number of bends in the piping) [m]

2. PURY-(E)P250, 300YLM-A1(-BS)

Equivalent length = (Actual piping length to the farthest indoor unit) + (0.42 × number of bends in the piping) [m]

3. PURY-(E)P350YLM-A1(-BS)

Equivalent length = (Actual piping length to the farthest indoor unit) + (0.47 × number of bends in the piping) [m]

4. PURY-(E)P400, 450, 500YLM-A1(-BS)

Equivalent length = (Actual piping length to the farthest indoor unit) + (0.50 × number of bends in the piping) [m]

Water pipe

Equivalent length = (Actual piping length to the farthest indoor unit) + (0.55 × number of bends in the piping) [m]

Water piping design

HBC water pipe connection sizes and pipe sizes.

Indoor unit	Connection size		Pipe size	
	Water inlet	Water outlet	Water out	Water return
PEFY-WP-VMS1 PEFY-WP-VMA PLFY-WP-VBM PFFY-WP-VLRMM	Rc 3/4 screw	Rc 3/4 screw	I.D.20mm	I.D.20mm

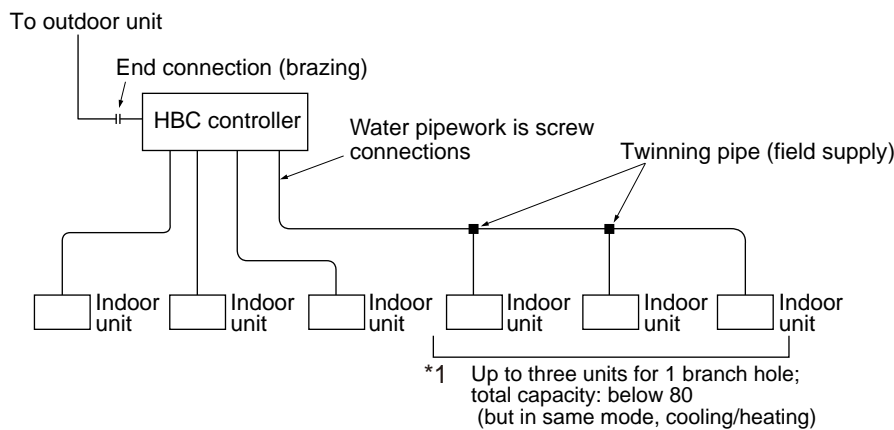

Note:

*1. Connection of multiple indoor units with one connection (or joint pipe)

- Total capacity of connectable indoor units: Less than 80
- Number of connectable indoor units: Maximum 3 Sets
- Selection of water piping
Select the size according to the total capacity of indoor units to be installed downstream.
- Please group units that operate on 1 branch.

2-4. Correction at frost and defrost

Due to frost at the outdoor heat exchanger and the automatic defrost operation, the heating capacity of the outdoor unit can be calculated by multiplying the correction factor shown in the table below.

Table of correction factor at frost and defrost

Outdoor inlet air temp. °C	6	4	2	1	0	-2	-4	-6	-8	-10	-20
Outdoor inlet air temp. °F	43	39	36	34	32	28	25	21	18	14	-4
PURY-(E)P200YLM-A1(-BS)	1.00	0.95	0.84	0.83	0.83	0.87	0.90	0.95	0.95	0.95	0.95
PURY-(E)P250YLM-A1(-BS)	1.00	0.95	0.84	0.83	0.83	0.87	0.90	0.95	0.95	0.95	0.95
PURY-(E)P300YLM-A1(-BS)	1.00	0.93	0.82	0.80	0.82	0.86	0.90	0.90	0.95	0.95	0.95
PURY-(E)P350YLM-A1(-BS)	1.00	0.93	0.85	0.83	0.84	0.86	0.90	0.90	0.95	0.95	0.95
PURY-(E)P400YLM-A1(-BS)	1.00	0.95	0.90	0.87	0.88	0.89	0.90	0.95	0.95	0.95	0.95
PURY-(E)P450YLM-A1(-BS)	1.00	0.98	0.89	0.87	0.89	0.90	0.92	0.95	0.95	0.95	0.95
PURY-(E)P500YLM-A1(-BS)	1.00	0.98	0.89	0.86	0.89	0.90	0.92	0.95	0.95	0.95	0.95

2. CAPACITY TABLES

2-5. Correction by antifreeze solution concentration

In HYBRID CITY MULTI system, antifreeze solution should be used to prevent the system from freezing. Refer to the following graphs for the capacity correction by antifreeze solution. Refer to 2-5-1 for antifreeze solution concentration, 2-5-2 and 2-5-3 for capacity correction by antifreeze solution concentration.

2-5-1. Antifreeze solution concentration

Use propylene glycol solution for antifreeze.

Refer to the following graph to estimate the antifreeze solution concentration required for freeze protection.

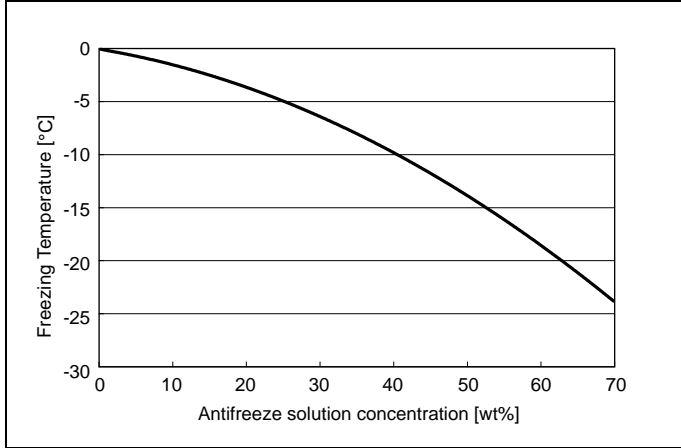

2-5-2. Capacity correction by antifreeze solution concentration (cooling)

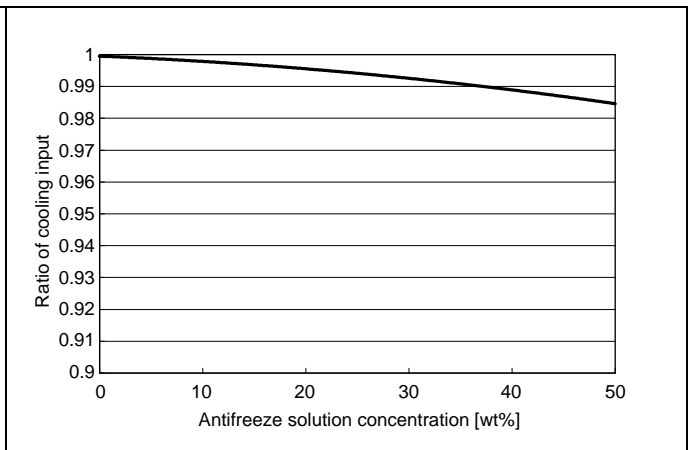
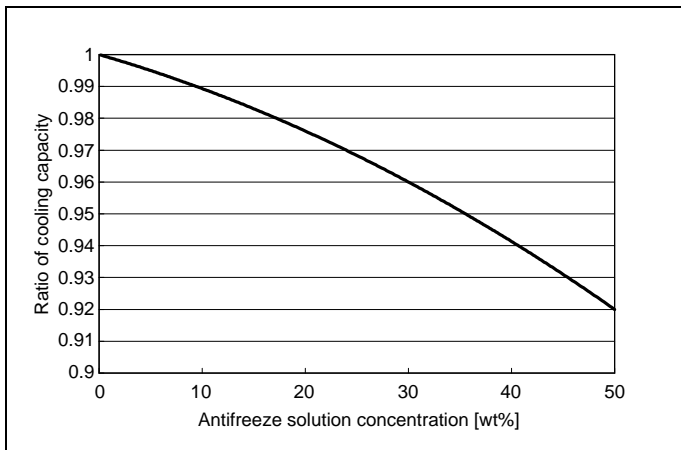

2-5-3. Capacity correction by antifreeze solution concentration (heating)

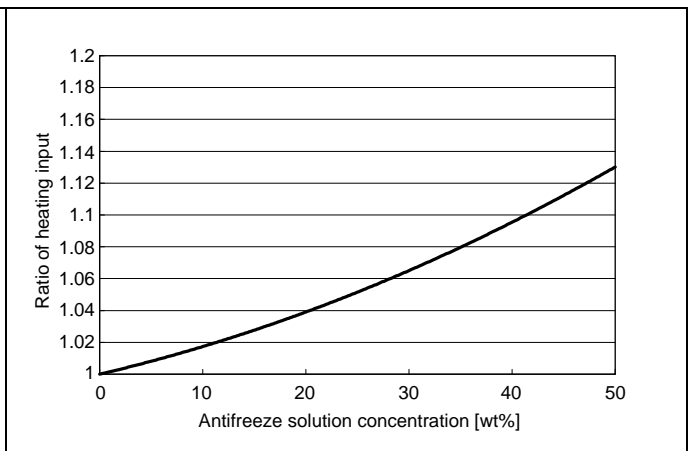
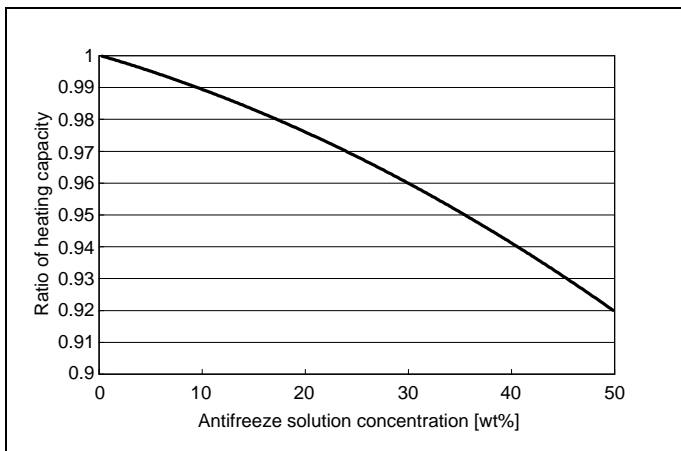

2. CAPACITY TABLES

2-6. Operation temperature range

• Cooling only

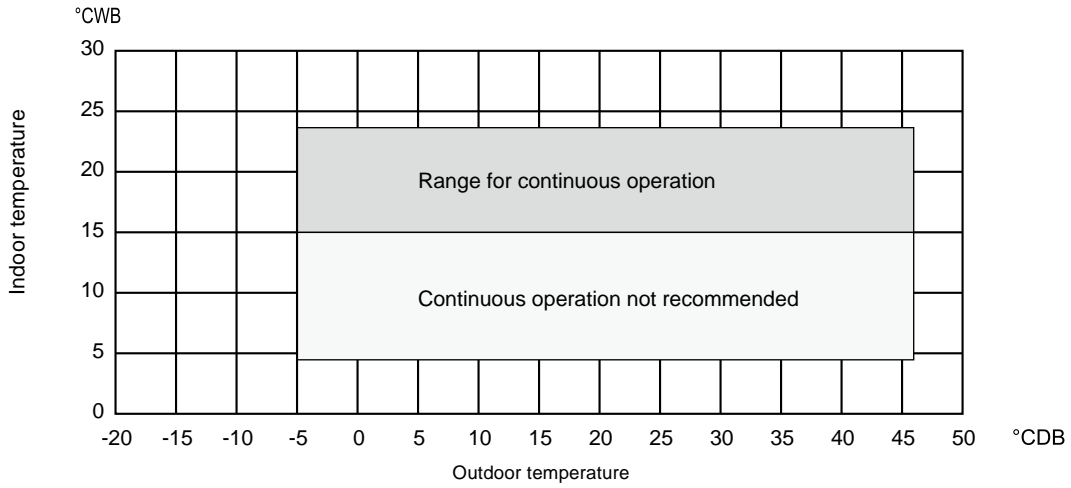

• Heating only

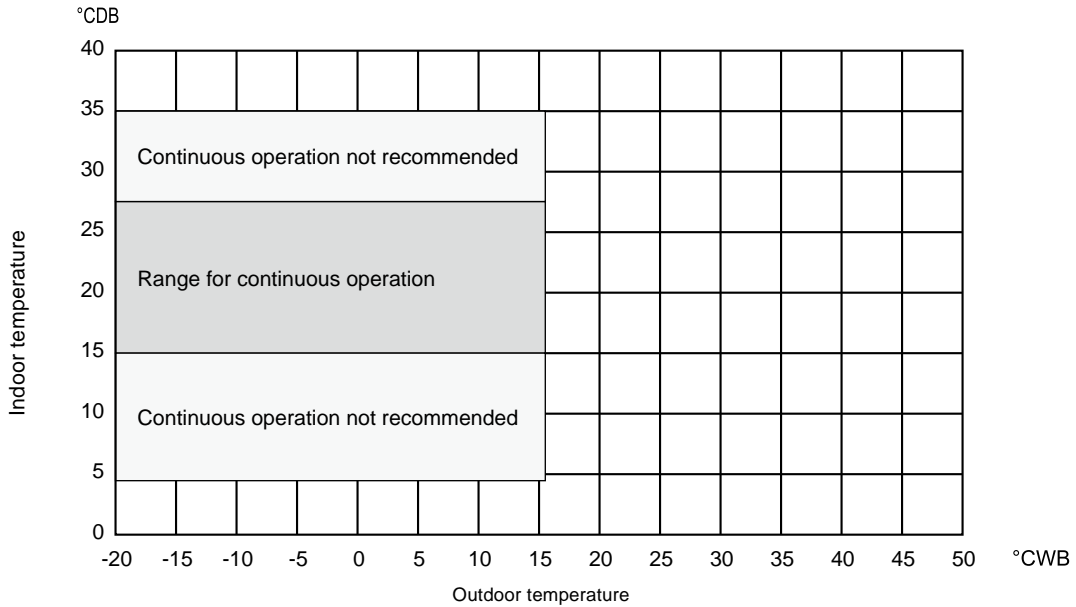

• Combination of cooling/heating operation (Cooling main or Heating main)

Outdoor temperature	Indoor temperature	
	Cooling	Heating
-10 to 21°CDB (14 to 70°FDB)	—	15 to 27°CDB (59 to 81°FDB)
-11 to 15.5°CWB (12.2 to 60°FWB)	15 to 24°CWB (59 to 75°FWB)	—

HYBRID CITY MULTI

3. SYSTEM DESIGN

SYSTEM DESIGN YLM SERIES..... 3 - 3

HYBRID CITY MULTI SYSTEM DESIGN YLM SERIES

1. Electrical work.....	3 - 4
1-1.Power supply for Indoor unit and Outdoor unit	3 - 4
2. M-NET control.....	3 - 6
2-1.Address setting.....	3 - 6
3. Piping Design.....	3 - 7
3-1.R410A Piping material	3 - 7
3-2.Piping Design	3 - 8
3-3.Refrigerant charging calculation	3 - 14
3-4.Water piping	3 - 15
4. Installation information.....	3 - 17
4-1.General precautions	3 - 17
4-2.Precautions for Indoor unit	3 - 18
4-3.Precautions for Outdoor unit/Heat source unit	3 - 19
4-4.Precautions for Control-related items	3 - 20

1. Electrical work

1-1. Power supply for Indoor unit and Outdoor unit

1-1-1. Electrical characteristics of the indoor unit

Symbols: MCA: Max.Circuit Amps (=1.25xFLA) FLA: Full Load Amps

IFM: Indoor Fan Motor Output: Fan motor rated output

PEFY-WP-VMA-E	Power supply			IFM	
	Volts / Hz	Range +-10%	MCA(A)	Output (kW)	FLA(A)
PEFY-WP20VMA-E	220-240V / 50Hz 220-240V / 60Hz	Max.: 264V Min.: 198V	1.18	0.085	0.95
PEFY-WP25VMA-E			1.43	0.085	1.14
PEFY-WP32VMA-E			1.54	0.085	1.23
PEFY-WP40VMA-E			2.47	0.121	1.98
PEFY-WP50VMA-E			2.47	0.121	1.98

PEFY-WP-VMS1-E	Power supply			IFM	
	Volts / Hz	Range +-10%	MCA(A)	Output (kW)	FLA(A)
PEFY-WP15VMS1-E	220-240V / 50Hz 220-240V / 60Hz	Max.: 264V Min.: 198V	0.63 / 0.63	0.096	0.50 / 0.50
PEFY-WP20VMS1-E			0.70 / 0.70	0.096	0.56 / 0.56
PEFY-WP25VMS1-E			0.75 / 0.75	0.096	0.60 / 0.60
PEFY-WP32VMS1-E			0.83 / 0.82	0.096	0.66 / 0.65
PEFY-WP40VMS1-E			1.02 / 1.00	0.096	0.81 / 0.80
PEFY-WP50VMS1-E			1.08 / 1.07	0.096	0.86 / 0.85

PLFY-WP-VBM-E	Power supply			IFM	
	Volts / Hz	Range +-10%	MCA(A)	Output (kW)	FLA(A)
PLFY-WP32VBM-E	220-240V / 50Hz 220-240V / 60Hz	Max.: 264V Min.: 198V	0.44	0.050	0.35
PLFY-WP40VBM-E			0.44	0.050	0.35
PLFY-WP50VBM-E			0.57	0.050	0.45

PFFY-WP-VLRMM-E	Power supply			IFM	
	Volts / Hz	Range +-10%	MCA(A)	Output (kW)	FLA(A)
PFFY-WP20VLRMM-E	220-240V / 50Hz 220-240V / 60Hz	Max.: 264V Min.: 198V	0.61	0.096	0.49
PFFY-WP25VLRMM-E			0.69	0.096	0.55
PFFY-WP32VLRMM-E			0.93	0.096	0.74
PFFY-WP40VLRMM-E			0.93	0.096	0.74
PFFY-WP50VLRMM-E			1.28	0.096	1.02

1. Electrical work

1-1-2. Electrical characteristics of the outdoor unit in cooling mode

Symbols: MCA: Max Circuit Amps

RLA: Rated Load Amps SC: Starting Current

PURY-P-YLM-A1	Unit Combination	Units			Power supply	Compressor		FAN	RLA(A)(50/60Hz)	
		Hz	Volts	Voltage range	MCA(A)	Output (kW)	SC(A)	Output(kW)	Cooling	Heating
PURY-P200YLM-A1(-BS)	-	50/60	380 400 415	Max:456V Min:342V	16.1	5.6	8	0.92	8.9/8.4/8.1	9.2/8.8/8.4
PURY-P250YLM-A1(-BS)	-				17.3	6.9	8	0.92	11.7/11.1/10.7	12.3/11.7/11.3
PURY-P300YLM-A1(-BS)	-				22.2	8.1	8	0.92	15.3/14.5/14.0	15.8/15.0/14.4
PURY-P350YLM-A1(-BS)	-				27.8	10.5	8	0.92	19.8/18.8/18.1	19.5/18.5/17.9
PURY-P400YLM-A1(-BS)	-				32.4	10.9	8	0.92	23.1/21.9/21.1	19.2/18.3/17.6
PURY-P450YLM-A1(-BS)	-				35.3	12.4	8	0.92	24.1/22.9/22.1	25.2/23.9/23.0
PURY-P500YLM-A1(-BS)	-				41.9	13.4	8	0.92	29.9/28.4/27.4	27.1/25.7/24.8

PURY-EP-YLM-A1	Unit Combination	Units			Power supply	Compressor		FAN	RLA(A)(50/60Hz)	
		Hz	Volts	Voltage range	MCA(A)	Output (kW)	SC(A)	Output(kW)	Cooling	Heating
PURY-EP200YLM-A1(-BS)	-	50/60	380 400 415	Max:456V Min:342V	16.1	5.6	8	0.92	9.2/8.7/8.4	10.8/10.2/9.9
PURY-EP250YLM-A1(-BS)	-				19.9	6.9	8	0.92	12.2/11.6/11.2	14.2/13.5/13.0
PURY-EP300YLM-A1(-BS)	-				23.6	8.1	8	0.92	15.5/14.7/14.2	16.8/15.9/15.4
PURY-EP350YLM-A1(-BS)	-				30.6	10.5	8	0.92	21.2/20.1/19.4	21.8/20.7/19.9
PURY-EP400YLM-A1(-BS)	-				31.7	10.9	8	0.92	21.2/20.1/19.4	22.6/21.4/20.7
PURY-EP450YLM-A1(-BS)	-				37.4	12.4	8	0.92	25.0/23.7/22.9	26.7/25.4/24.5
PURY-EP500YLM-A1(-BS)	-				46.1	13.4	8	0.92	31.4/29.8/28.7	32.9/31.3/30.2

1-1-3. Electrical characteristics of the HBC controller

























Symbols: MCA: Max. Circuit Amps, MFA: Max. Fuse Amps, RLA: Rated Load Amps

HBC controller	Power supply					RLA(A)
	Hz	Volts	Range+-10%	MCA(A)	MFA(A)	
CMB-WP108V-GA1 CMB-WP1016V-GA1	50/60	220	Max.: 264V Min.: 198V	3.49	15	2.89
		230				2.83
		240				2.79
CMB-WP108V-GB1 CMB-WP1016V-GB1	50/60	220	Max.: 264V Min.: 198V	0.06	15	0.05
		230				0.05
		240				0.05

2. M-NET control

2-1. Address setting

2-1-1. Rule of setting address

Unit	Address setting	Example	Note	
Indoor unit	01 ~ 50	 	Use the most recent address within the same group of indoor units.	
Outdoor unit	51 ~ 99, 100 (Note1)	 	The smallest address of indoor unit in same refrigerant system + 50 Assign sequential address numbers to the outdoor units in one refrigerant circuit system. OC, OS1 and OS2 are automatically detected. (Note 2) * Please reset one of them to an address between 51 and 99 when two addresses overlap. * The address automatically becomes "100" if it is set as "01~ 50"	
HBC controller	52 ~ 99, 100	 	The address of the smallest address of indoor unit connected to the HBC controller +50 * Please reset one of them to an address between 51 and 99 when two addresses overlap. The address automatically becomes "100" if it is set as "01~ 50"	
Local remote controller	ME, LOSSNAY Remote controller (Main)	101 ~ 150 1 Fixed	 	The smallest address of indoor unit in the group + 100 * The place of "100" is fixed to "1"
	ME, LOSSNAY Remote controller (Sub)	151 ~ 199, 200 1 Fixed	 	The address of main remote controller + 50 * The address automatically becomes "200" if it is set as "00"
System controller	ON/OFF remote controller	000, 201 ~ 250   	The smallest group No. to be managed + 200 * The smallest group No. to be managed is changeable.	
	AE-200E/AE-50E EW-50E AG-150A AT-50B EB-50GU-J	000, 201 ~ 250   		
	PAC-YG50ECA	000, 201 ~ 250   	* Settings are made on the initial screen of AG-150A.	
	BAC-HD150	000, 201 ~ 250   	* Settings are made with setting tool of BM ADAPTER.	
	LMAP04-E	201 ~ 250 2 Fixed	 	

Note1: To set the address to "100", set it to "50"

Note2: Outdoor units OC, OS1 and OS2 in one refrigerant circuit system are automatically detected.
OC, OS1 and OS2 are ranked in descending order of capacity. If units are the same capacity, they are ranked in ascending order of their address.

3. Piping Design

3-1. R410A Piping material

Refrigerant pipe for CITY MULTI shall be made of phosphorus deoxidized copper, and has two types.

- A. Type-O: Soft copper pipe (annealed copper pipe), can be easily bent with human's hand.
 B. Type-1/2H pipe: Hard copper pipe (Straight pipe), being stronger than Type-O pipe of the same radical thickness.

The maximum operation pressure of R410A air conditioner is 4.30 MPa [623psi]. The refrigerant piping should ensure the safety under the maximum operation pressure. MITSUBISHI ELECTRIC recommends pipe size as Table 3-1, or You shall follow the local industrial standard. Pipes of radical thickness 0.7mm or less shall not be used.

Table 3-1. Copper pipe size and radial thickness for R410A CITY MULTI.

Size (mm)	Size (inch)	Radial thickness (mm)	Radial thickness (mil)	Pipe type
ø6.35	ø1/4"	0.8	[32]	Type-O
ø9.52	ø3/8"	0.8	[32]	Type-O
ø12.7	ø1/2"	0.8	[32]	Type-O
ø15.88	ø5/8"	1.0	[40]	Type-O
ø19.05	ø3/4"	1.2	[48]	Type-O
ø19.05	ø3/4"	1.0	[40]	Type-1/2H or H
ø22.2	ø7/8"	1.0	[40]	Type-1/2H or H
ø25.4	ø1"	1.0	[40]	Type-1/2H or H
ø28.58	ø1-1/8"	1.0	[40]	Type-1/2H or H
ø31.75	ø1-1/4"	1.1	[44]	Type-1/2H or H
ø34.93	ø1-3/8"	1.2	[48]	Type-1/2H or H
ø41.28	ø1-5/8"	1.4	[56]	Type-1/2H or H

* For pipe sized ø19.05 (3/4") for R410A air conditioner, choice of pipe type is up to you.

* The figures in the radial thickness column are based on the Japanese standards and provided only as a reference. Use pipes that meet the local standards.

Flare

Due to the relative higher operation pressure of R410A compared to R22, the flare connection should follow dimensions mentioned below so as to achieve enough the air-tightness.

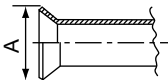
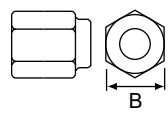
Flare pipe	Pipe size	A (For R410A) (mm[in.])	Flare nut	Pipe size	B (For R410A) (mm[in.])
	ø6.35 [1/4"]	9.1		ø6.35 [1/4"]	17.0
	ø9.52 [3/8"]	13.2		ø9.52 [3/8"]	22.0
	ø12.70 [1/2"]	16.6		ø12.70 [1/2"]	26.0
	ø15.88 [5/8"]	19.7		ø15.88 [5/8"]	29.0
	ø19.05 [3/4"]	24.0		ø19.05 [3/4"]	36.0

3. Piping Design

3-2. Piping Design

3-2-1. Restrictions on pipe length

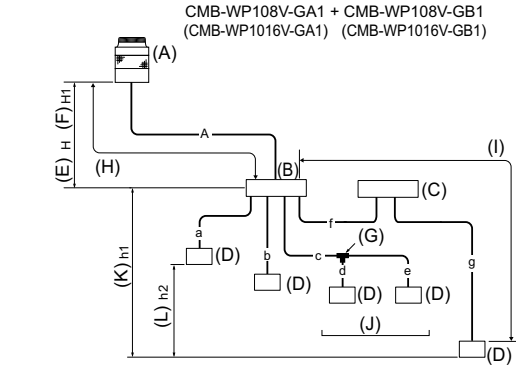

- (A) Outdoor unit (~E)P350 (B) Main-HBC controller
 (C) Sub-HBC controller (D) Indoor unit
 (E) Less than H=50 m (when the outdoor unit is higher than HBC)
 (F) Less than H1=40 m (when the outdoor unit is lower than HBC)
 (G) Twinned pipe (field supply)
 (H) Less than 110 m (I) Less than 60 m
 (J) Up to three units for 1 branch port
 Total capacity: less than 80 (but in same mode, cooling/heating)
 (K) Less than 15 m (L) Less than 15 m

Note:1.

Indoor units that are connected to the same branch joint cannot be simultaneously operated in different operation modes.

(Unit: m)

Item		Piping portion	Allowable value
Pipe Lengths	Between outdoor unit and HBC controller (refrigerant pipework)	A	110 or less
	Water pipework between indoor units and HBC controller	f + g	60 or less
Difference of elevation	Between HBC and outdoor units	Outdoor unit above HBC	H
		Outdoor unit below HBC	H1
Between indoor units and HBC controller		h1	15(10) or less*1
Between indoor units		h2	15(10) or less*1

*1. Values in () are applied when indoor total capacity exceeds 130% of outdoor unit capacity

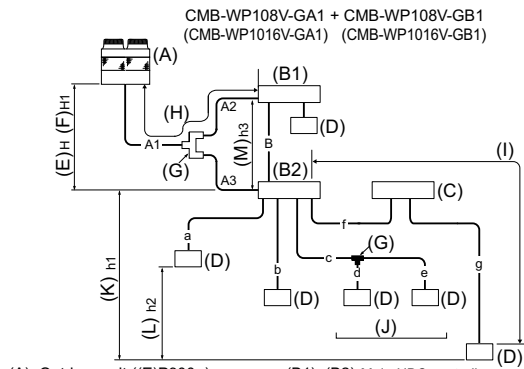

- (A) Outdoor unit ((E)P300~) (B1), (B2) Main-HBC controller
 (C) Sub-HBC controller
 Total indoor units capacity (B2)+(C): P375 or less
 (D) Indoor unit
 (E) Less than H=50 m (when the outdoor unit is higher than HBC)
 (F) Less than H1=40 m (when the outdoor unit is lower than HBC)
 (G) Twinned pipe (field supply)
 (H) Less than 110 m (I) Less than 60 m
 (J) Up to three units for 1 branch port
 Total capacity: less than 80 (but in same mode, cooling/heating)
 (K) Less than 15 m (L) Less than 15 m
 (M) Less than 15 m

(Unit: m)

Item		Piping portion	Allowable value
Pipe Lengths	Between outdoor unit and HBC controller (refrigerant pipework)	A1 + A2 + A3	110 or less
	Water pipework between indoor units and HBC controller	f + g	60 or less
	Between HBC controllers	B	40 or less
Difference of elevation	Between HBC and outdoor units	Outdoor unit above HBC	H
		Outdoor unit below HBC	H1
Between indoor units and HBC controller		h1	15(10) or less*1
Between indoor units		h2	15(10) or less*1
Between HBC controllers		h3	15(10) or less*1

*1. Values in () are applied when indoor total capacity exceeds 130% of outdoor unit capacity

3. Piping Design

1. Refrigerant and water pipe size

(1) Refrigerant pipe between outdoor unit and HBC controller (Part A, A1, A2, and A3)

Use of one HBC controller

Unit model	Model name	HBC CONTROLLER		
		High pressure side	Low pressure side	
Outdoor unit side	PURY-(E)P200	(HBC CONTROLLER)	ø15.88 (Brazing)	ø19.05 (Brazing)
	PURY-(E)P250	CMB-WP108V-GA1	ø19.05 (Brazing)	ø22.2 (Brazing)
	PURY-(E)P300	CMB-WP1016V-GA1	ø19.05 (Brazing)	ø22.2 (Brazing)
	PURY-(E)P350	*1	ø19.05 (Brazing)	ø28.58 (Brazing)

Use of two HBC controllers

Unit model	Model name	HBC CONTROLLER			
		Between outdoor unit and twining pipe		Between twining pipe and HBC	
		High pressure side	Low pressure side	High pressure side	Low pressure side
Outdoor unit side	PURY-(E)P300	ø19.05 (Brazing)	ø22.2 (Brazing)	ø15.88 (Brazing) for each HBC	ø19.05 (Brazing) for each HBC
	PURY-(E)P350	ø19.05 (Brazing)	ø28.58 (Brazing)	ø15.88 (Brazing) for each HBC	ø19.05 (Brazing) for each HBC
	PURY-(E)P400	ø22.2 (Brazing)	ø28.58 (Brazing)	ø15.88 (Brazing) for each HBC	ø19.05 (Brazing) for each HBC
	PURY-(E)P450	ø22.2 (Brazing)	ø28.58 (Brazing)	ø19.05 (Brazing) for each HBC	ø22.2 (Brazing) for each HBC
	PURY-(E)P500	ø22.2 (Brazing)	ø28.58 (Brazing)	ø19.05 (Brazing) for each HBC	ø22.2 (Brazing) for each HBC

*1. PURY-(E)P-400YLM model or larger requires a connection of two main-HBC controllers in parallel.

(2) Water pipe between HBC controller and indoor units (Sections a, b, c, d, e, and g)

Unit: mm [inch]

Indoor unit	Inlet pipe size	Outlet pipe size
P15 - P50	20A	20A

*Water Pipe size between HBC controller and joint is also 20A.

(3) Water pipe between HBC controller and Sub-HBC

Unit: mm [inch]

	Inlet pipe size	Outlet pipe size
Cold-water side	ø25.4[I.D. 1"]	ø25.4[I.D. 1"]
Hot-water side	ø25.4[I.D. 1"]	ø25.4[I.D. 1"]

(4) Refrigerant pipe between HBC controller and HBC controller

Unit: mm [inch]

ø15.88 [5/8"] (Brazed connection)

2. Connecting the HBC controller

(1) Size of the pipe that fits the standard HBC controller ports

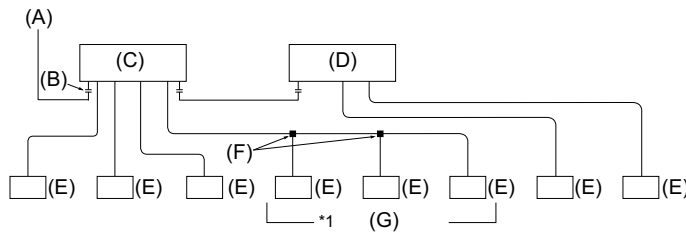

- (A) To outdoor unit
- (B) End connection (brazing)
- (C) Main-HBC controller
- (D) Sub-HBC controller
- (E) Indoor unit
- (F) Twining pipe (field supply)
- (G) Up to three units for 1 branch hole; total capacity: below 80 (but same in cooling/heating mode)

Note:

- 1) To connect multiple indoor units to a port
 - Maximum total capacity of connected indoor units: P80 or below
 - Maximum number of connectable indoor units: 3 units
 - Branch joints are field-supplied.

All the indoor units that are connected to the same port must be in the same group and Thermo-ON/OFF operation simultaneously. For all the indoor units in the group, the room temperature needs to be monitored via the connected remote controller.

3. Piping Design

3-2-2. Drain piping work

1. Drain piping work

- Ensure that the drain piping is sloped downward (sloped gradient of more than 1/100) toward the discharge side. If it is impossible to take any downward pitch, use an optionally available drain pump to obtain a downward pitch of more than 1/100.
- Ensure that any horizontal drain piping sections that are longer than 20 m are supported with metal brackets to prevent it from bending, warping, or vibrating.
- Connect the supplied drain hose to the discharge port on the unit. Use hardvinyl chloride pipes VP-25 (ø32) for drain piping (2). Tighten the supplied drain hose onto the discharge port using the supplied hose band. (For this, do not use any adhesive because the drain hose will need to be removed for servicing at a later date.)
- Do not use any odor trap around the discharge port.

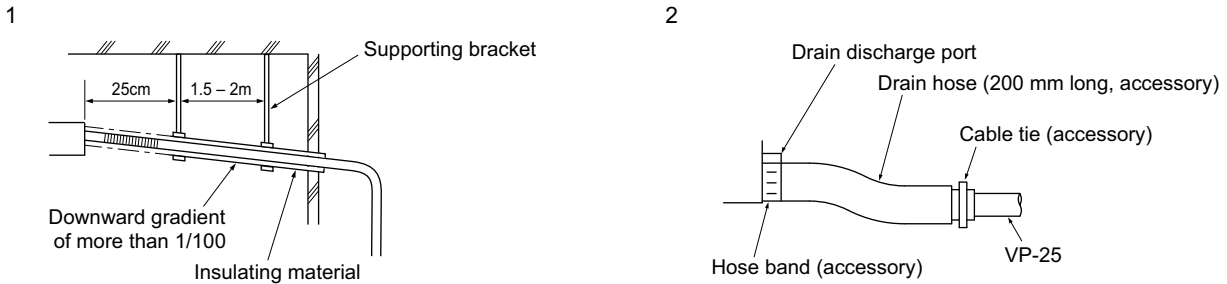

- As shown in 3, install a collecting pipe about 10 cm below the drain ports and give it a downward pitch of more than 1/100. This collecting pipe should be of VP-30.
- Set the end of drain piping in a place without any risk of odor generation.
- Do not put the end of the drain piping into any drain where ionic gases are generated.
- Drain piping may be installed in any direction. However, please be sure to observe the above instructions.

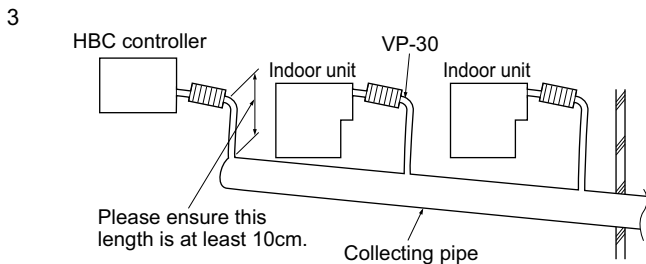

2. Discharge test

After completing drain piping work, open the HBC controller panel, and test drain discharge using a small amount of water. Also, check to see that there is no water leakage from the connections.

3. Insulating drain pipes

Provide sufficient insulation to the drain pipes just as for refrigerant pipes.

⚠ CAUTION

Be sure to provide drain piping with heat insulation in order to prevent excess condensation. Without drain piping, water may leak from the unit causing damage to your property.

3. Piping Design

3-2-3. Connecting water pipework

Please observe the following precautions during installation.

3-2-3-1 Important notes on water pipework installation

- The design pressure of the HBC water system is 0.6MPa.
- Use water pipe-work with a design pressure of at least 1.0MPa.
- When performing a water leak check, please do not allow the water pressure to go above 0.3MPa.
- Please connect the water pipework of each indoor unit to the correct port on the HBC. Failure to do so will result in incorrect running.
- Please list the indoor units on the naming plate in the HBC unit with addresses and end connection numbers.
- If the number of indoor units are less than the number of ports on the HBC, the unused ports must be capped. Without a cap, water will leak.
- Use the reverse-return method to insure proper pipe resistance to each unit.
- Provide some joints and bulbs around inlet/outlet of each unit for easy maintenance, checkup, and replacement.
- Install a suitable air vent on the water pipe. After flowing water through the pipe, vent any excess air.
- Secure the pipes with metal fittings, positioning them in locations to protect pipes against breakage and bending.
- Do not confuse the water intake and outlet piping. (Error code 5102 will appear on the remote controller if a test run is performed with the pipe-work installed incorrectly (inlet connected to outlet and vice versa).)
- This unit doesn't include a heater to prevent freezing within the pipe work. If the system is stopped for an extended period during low ambient conditions, drain the water out.
- The unused knockout holes should be closed and the refrigerant pipes, water pipes, power source and transmission wires access holes should be filled with putty.
- Install water pipe so that the water flow rate will be maintained.
- Wrap sealing tape as follows.
 1. Wrap the joint with sealing tape following the direction of the threads (clockwise), do not wrap the tape over the edge.
 2. Overlap the sealing tape by two-thirds to three-fourths of its width on each turn. Press the tape with your fingers so that it is tight against each thread.
 3. Do not wrap the 1.5th through 2nd farthest threads away from the pipe end.
- Hold the pipe on the unit side in place with a spanner when installing the pipes or strainer. Tighten screws to a torque of 40 N·m.
- If there is a risk of freezing, take precautions to prevent this happening.
- When connecting the HBC unit water piping and on site water piping, apply liquid sealing material for water piping over the sealing tape before connection.
- Please use copper or plastic pipes for the water circuit. Do not use steel or stainless steel pipework. Furthermore, when using copper pipe-work, use a non-oxidative brazing method. Oxidation of the pipe-work will reduce the pump life.

Example of heat source unit installation (using left piping)

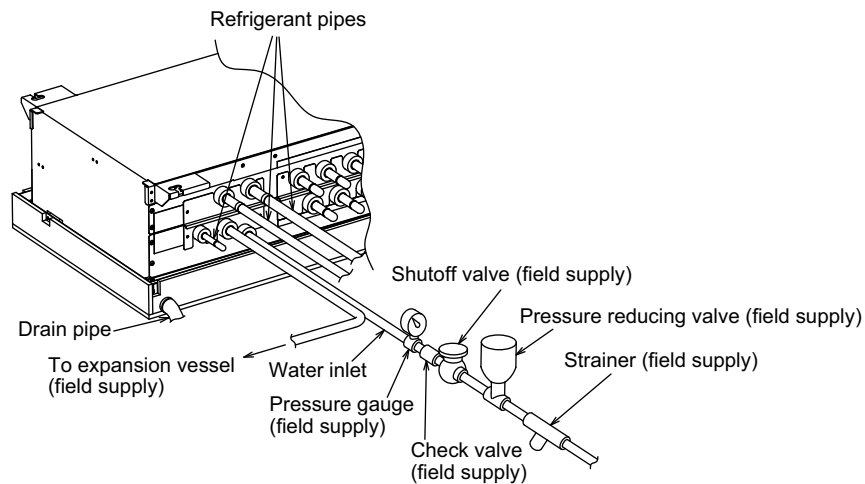

HBC controller sample installation (*1)

*1. Connect the pipes to the water pipes according to the local regulations.

- The HBC system must be serviced at least once a year.

3. Piping Design

3-2-3-2 Water pipe insulation

1. Connect the water pipes of each indoor unit to the same (correct) end connection numbers as indicated on the indoor unit connection section of each HBC controller. If connected to wrong end connection numbers, there will be no normal operation.
2. List indoor unit model names in the name plate on the HBC controller control box (for identification purposes), and HBC controller end connection numbers and address numbers in the name plate on the indoor unit side.
Seal unused end connections using cover caps (field supply, dezincification resistant brass (DZR) or bronze only). Not replacing the rubber end caps will lead to water leakage.
3. Be sure to add insulation work to water piping by covering water pipework separately with enough thickness heat-resistant polyethylene, so that no gap is observed in the joint between indoor unit and insulating material, and insulating materials themselves. When insulation work is insufficient, there is a possibility of condensation, etc. Pay special attention to insulation work in the ceiling plenum.

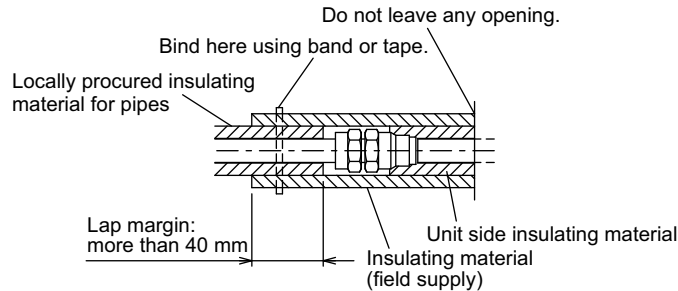

- Insulation materials for the pipes to be added on site must meet the following specifications:

HBC controller -indoor unit	20 mm or more
--------------------------------	---------------

- This specification is based on copper for water piping. When using plastic pipework, choose a thickness based on the plastic pipe performance.
 - Installation of pipes in a high-temperature high-humidity environment, such as the top floor of a building, may require the use of insulation materials thicker than the ones specified in the chart above.
 - When certain specifications presented by the client must be met, ensure that they also meet the specifications on the chart above.
4. Expansion vessel
- Install an expansion tank to accommodate expanded water.

Expansion vessel selection criteria:

- The water containment volume of the HBC, the indoor units, and pipe work.

(Unit: L)

Unit model	Water volume
CMB-WP108V-GA1	10
CMB-WP1016V-GA1	13
CMB-WP108V-GB1	5
CMB-WP1016V-GB1	9
PEFY-WP15VMS1	0.7
PEFY-WP20VMS1	0.9
PEFY-WP25VMS1	
PEFY-WP32VMS1	1.0
PEFY-WP40VMS1	
PEFY-WP50VMS1	1.7
PEFY-WP20VMA	0.7
PEFY-WP25VMA	1
PEFY-WP32VMA	
PEFY-WP40VMA	
PEFY-WP50VMA	1.8
PLFY-WP32VBM-E	
PLFY-WP40VBM-E	
PLFY-WP50VBM-E	1.5
PFFY-WP20VLRMM-E	
PFFY-WP25VLRMM-E	0.9
PFFY-WP32VLRMM-E	1.3
PFFY-WP40VLRMM-E	
PFFY-WP50VLRMM-E	
PFFY-WP50VLRMM-E	1.5

- The maximum water temperature is 60°C.
- The minimum water temperature is 5°C.
- The circuit protection valve set pressure is 370-490kPa.
- The circulation pump head pressure is 0.24MPa.

3. Piping Design

5. Leakproof the water pipework, valves and drain pipework. Leakproof all the way to, and include pipe ends so that condensation cannot enter the insulated pipework.
6. Apply caulking around the ends of the insulation to prevent condensation getting between the pipework and insulation.
7. Add a drain valve so that the unit and pipework can be drained.
8. Ensure there are no gaps in the pipework insulation. Insulate the pipework right up to the unit.
9. Ensure that the gradient of the drain pan pipework is such that discharge can only flow out.
10. HBC water pipe connection sizes and pipe sizes.

	Connection size		Pipe size	
	Water inlet	Water outlet	Water out	Water return
Indoor unit	Rc 3/4 screw	Rc 3/4 screw	I.D. 20 mm	I.D. 20 mm

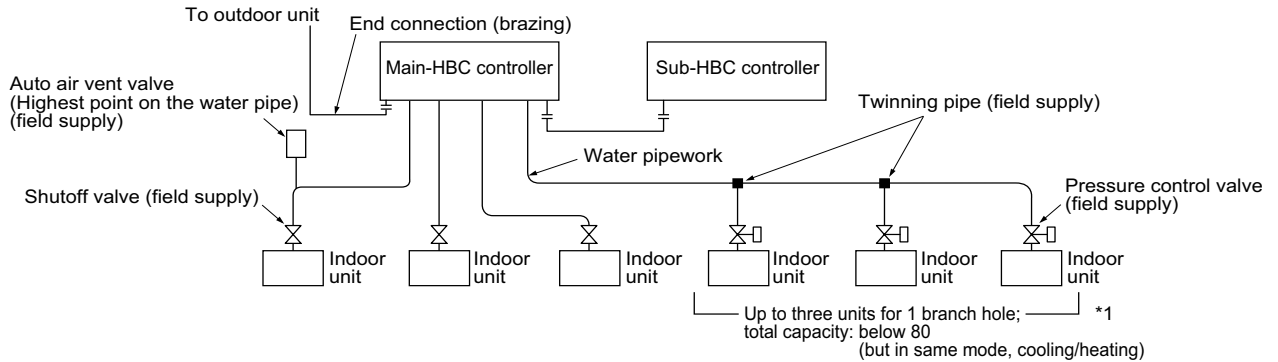

Note:

*1. Connection of multiple indoor units with one connection (or joint pipe)

- Total capacity of connectable indoor units: Less than 80
- Number of connectable indoor units: Maximum 3 units
- Selection of water piping
Select the size according to the total capacity of indoor units to be installed downstream.
- Please group units that operate on 1 branch.

11. Please refer to the figure below when connecting the water supply.

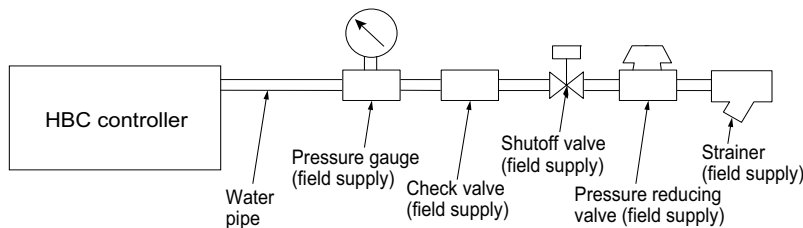

12. Use formula $0.1 \leq 0.01 + 0.01 \times A \leq 0.16$ for the supply pressure range to be used.
(A: Head pressure (m) between the HBC and the highest indoor unit)
If the supply pressure is greater than 0.16 MPa, use a pressure reducing valve to keep the pressure within the range.
If the head pressure is unknown, set it to 0.16 MPa.
13. Install a shut off valve and strainer in a place that is easy to operate and makes maintenance work easy.
14. Apply insulation to the indoor unit pipework, strainer, shut off valve, and pressure reducing valve.
15. Please do not use a corrosion inhibitor in the water system.
16. When installing the HBC unit in an environment which may drop below 0°C, please add antifreeze (Propylene Glycol only) to the circulating water. For the brine selection, refer to 2-5. "Correction by antifreeze solution concentration" in chapter "Outdoor Unit".

3-2-3-3 Water treatment and quality control

To preserve water quality, use the closed type of water circuit. When the circulating water quality is poor, the water heat exchanger can develop scale, leading to a reduction in heat-exchange power and possible corrosion. Pay careful attention to water processing and water quality control when installing the water circulation system.

- Removing of foreign objects or impurities within the pipes.
During installation, make sure that foreign objects, such as welding fragments, sealant particles, or rust, do not enter the pipes.
- Water Quality Processing

Depending on the quality of the cold-temperature water used in the air conditioner, the copper piping of the heat exchanger may corrode. Regular water quality processing is recommended. If a water supply tank is installed, keep air contact to a minimum, and keep the level of dissolved oxygen in the water no higher than 1mg/l.

3. Piping Design

3-3. Refrigerant charging calculation

Example

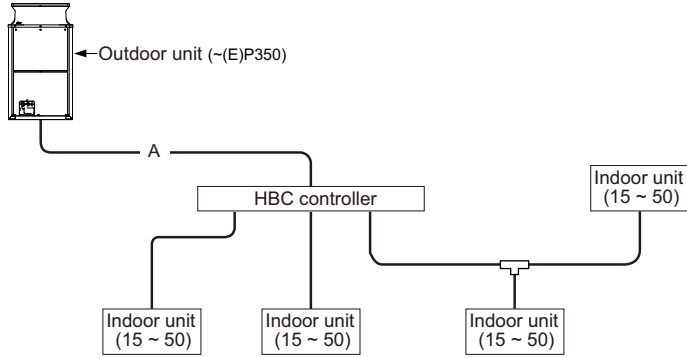

■ Sample calculation

Indoor 1: 50 A: ø19.05 42 m
 2: 50
 3: 50
 4: 40
 Outdoor P250

The total length of each liquid line is as follows:
 ø19.05: A = 42 m, α₁ = 3.0
 Therefore,
 <Calculation example>
 Additional refrigerant charge
 = 42 × 0.14 + 3.0
 = 8.88 kg
 ≈ 8.9 kg

* All pipe work except A is water pipe work.

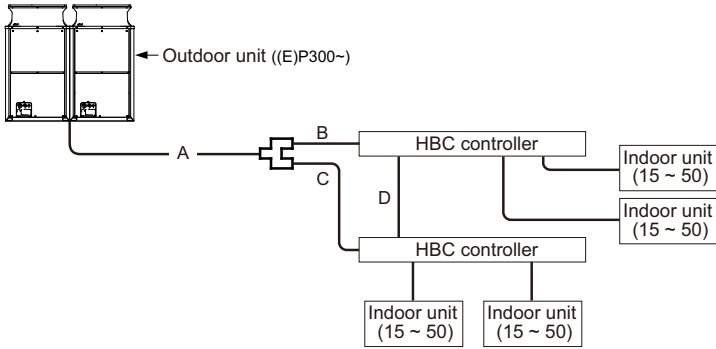

Indoor 1: 50 A: ø22.2 18 m
 2: 50 B: ø15.88 5 m
 3: 50 C: ø15.88 10 m
 4: 50 D: ø15.88 8 m
 Outdoor P400

The total length of each liquid line is as follows:
 ø22.2: A = 18 m, ø15.88: B + C + D = 23m, α₁ = 3.0 × 2
 Therefore,
 <Calculation example>
 Additional refrigerant charge
 = 18 × 0.23 + (5 + 10 + 8) × 0.11 + 3.0 × 2
 = 12.67 kg
 ≈ 12.7 kg

* All pipe work except A, B, C, D is water pipe work.

<Amount of refrigerant to be added>

The amount of refrigerant that is shown in the table below is factory-charged to the outdoor units. The amount necessary for extended pipe (field piping) is not included and must be added on site.

Outdoor unit model	Amount of pre-charged refrigerant in the outdoor unit (kg)	Outdoor unit model	Amount of pre-charged refrigerant in the outdoor unit (kg)
P200YLM	9.5	P400YLM	10.3
P250YLM	9.5	P450YLM	11.8
P300YLM	10.3	P500YLM	11.8
P350YLM	10.3		

Outdoor unit model	Amount of pre-charged refrigerant in the outdoor unit (kg)
EP200YLM	6.0
EP250YLM	6.0
EP300YLM	8.0
EP350YLM	8.0
EP400YLM	10.5
EP450YLM	11.8
EP500YLM	11.8

■ Calculation formula

The amount of refrigerant to be added depends on the size and the length of field piping. (unit in m[ft])

- When the distance between HBC and outdoor unit is longer than 30.5m:
 Amount of added refrigerant (kg) = (0.21×L₁) + (0.14×L₂) + (0.11×L₃) + α₁
- When the distance between HBC and outdoor unit is 30.5m or shorter:
 Amount of added refrigerant (kg) = (0.23×L₁) + (0.16×L₂) + (0.11×L₃) + α₁
 L₁ : Length of ø22.2 [7/8"] high pressure pipe (m)
 L₂ : Length of ø19.05 [3/4"] high pressure pipe (m)
 L₃ : Length of ø15.88 [5/8"] high pressure pipe (m)
 α₁ : Refer to the table below.

Use of one HBC controller

Outdoor unit index	Diameter of high-pressure pipe	Amount for the HBC controller α ₁ (kg)
(E)P200	ø15.88	
(E)P250	ø19.05	3.0
(E)P300	ø19.05	
(E)P350	ø19.05	

Use of two HBC controllers

Outdoor unit index	Diameter of high-pressure pipe	Amount for the HBC controller α ₁ (kg)
(E)P300	ø19.05	
(E)P350	ø19.05	3.0
(E)P400	ø22.20	
(E)P450	ø22.20	
(E)P500	ø22.20	

× 2

Round up the calculation result to the nearest 0.1kg. (Example: 18.04kg to 18.1kg)

3. Piping Design

3-4. Water piping

3-4-1. Precautions for water piping

Consider the following when installing a water piping system.

1. Design pressure of the water piping
Use a water pipe that is strong enough to withstand the design pressure (1.0 MPa).
2. Water pipe type
Use of plastic pipe is recommended.
When using copper pipes, be sure to braze the pipes under a nitrogen purge. (Oxidation during may shorten the life of the pump.)
3. Expansion vessel
Install an expansion vessel to accommodate expanded water.
4. Drain piping
Install the drain pipe with a downward inclination of between 1/100 and 1/200. To prevent drain water from freezing in winter, install the drain pipe as steep an angle as practically possible and minimize the straight line. For cold climate installation, take an appropriate measure (e.g., drain heater) to prevent the drain water from freezing.
5. Insulation
Cover the water pipe with insulating materials with the specified thickness or more to prevent thermal loss or condensation from collecting.
6. Air vent valve
Install air vent valves to the highest places where air can accumulate.
7. Maintenance valve
It is recommended to install valves on the inlet/outlet for each HBC controller branch for maintenance.
8. Water pressure gauge
Install a water pressure gauge to check the charged pressure.

3. Piping Design

3-4-2. Notes on corrosion

1. Water quality

It is important to check the water quality beforehand. See table below (Circulating water/Makeup Water Quality Standards).

Items		Lower mid-range temperature water system		Tendency	
		Recirculating water [20<T<60°C] [68<T<140°F]	Make-up water	Corrosive	Scale-forming
Standard items	pH (25°C[77°F])	7.0 ~ 8.0	7.0 ~ 8.0	○	○
	Electric conductivity (mS/m) (25°C[77°F]) (μS/cm) (25°C[77°F])	30 or less [300 or less]	30 or less [300 or less]	○	○
	Chloride ion (mg Cl ⁻ /ℓ)	50 or less	50 or less	○	
	Sulfate ion (mg SO ₄ ²⁻ /ℓ)	50 or less	50 or less	○	
	Acid consumption (pH4.8) (mg CaCO ₃ /ℓ)	50 or less	50 or less		○
	Total hardness (mg CaCO ₃ /ℓ)	70 or less	70 or less		○
	Calcium hardness (mg CaCO ₃ /ℓ)	50 or less	50 or less		○
Reference items	Ionic silica (mg SiO ₂ /ℓ)	30 or less	30 or less		○
	Iron (mg Fe/ℓ)	1.0 or less	0.3 or less	○	○
	Copper (mg Cu/ℓ)	1.0 or less	0.1 or less	○	
	Sulfide ion (mg S ²⁻ /ℓ)	not to be detected	not to be detected	○	
	Ammonium ion (mg NH ₄ ⁺ /ℓ)	0.3 or less	0.1 or less	○	
	Residual chlorine (mg Cl/ℓ)	0.25 or less	0.3 or less	○	
	Free carbon dioxide (mg CO ₂ /ℓ)	0.4 or less	4.0 or less	○	
Ryzner stability index	-	-	○	○	

Reference : Guideline of Water Quality for Refrigeration and Air Conditioning Equipment. (JRA GL02E-1994)

2. Debris in the water

Sand, pebbles, suspended solids, and corrosion products in water can damage the metal pipe and heat exchanger on the HBC controller and may cause corrosion. When installing, prevent debris from entering the water. If there is debris in the water, perform debris removal operation after test run by cleaning the strainers inside the HBC controller. (Refer to other sections for how to perform a test run.)

3. Connecting pipes made of different materials

Connecting pipes used for HBC controller and indoor unit are copper alloy pipes. If steel pipes are connected to the pipes, the contact surface will corrode. Do not use steel pipes to avoid corrosion.

4. Residual air

Residual air in the pipe results in water pump malfunction, noise, or water pipe corrosion in the water circuit. Ensure air is purged before use. (Refer to other sections for how to perform air vent operation.)

4. Installation information

4-1. General precautions

4-1-1. Usage

- The air-conditioning system described in this Data Book is designed for human comfort.
- This product is not designed for preservation of food, animals, plants, precision equipment, or art objects. To prevent quality loss, do not use the product for purposes other than what it is designed for.
- To reduce the risk of water leakage and electric shock, do not use the product for air-conditioning vehicles or vessels.

4-1-2. Installation environment

- Do not install any unit other than the dedicated unit in a place where the voltage changes a lot, large amounts of mineral oil (e.g., cutting oil) are present, cooking oil may splash, or a large quantity of steam can be generated such as a kitchen.
- Do not install the unit in acidic or alkaline environment.
- Installation should not be performed in the locations exposed to chlorine or other corrosive gases. Avoid near a sewer.
- To reduce the risk of fire, do not install the unit in a place where flammable gas may be leaked or inflammable material is present.
- This air conditioning unit has a built-in microcomputer. Take the noise effects into consideration when deciding the installation position. Especially in a place where antenna or electronic device are installed, it is recommended that the air conditioning unit be installed away from them.
- Install the unit on a solid foundation according to the local safety measures against typhoons, wind gusts, and earthquakes to prevent the unit from being damaged, toppling over, and falling.

4-1-3. Backup system

- In a place where air conditioner's malfunctions may exert crucial influence, it is recommended to have two or more systems of single outdoor units with multiple indoor units.

4-1-4. Unit characteristics

- Heat pump efficiency depends on outdoor temperature. In the heating mode, performance drops as the outside air temperature drops. In cold climates, performance can be poor. Warm air would continue to be trapped near the ceiling and the floor level would continue to stay cold. In this case, heat pumps require a supplemental heating system or air circulator. Before purchasing them, consult your local distributor for selecting the unit and system.
- When the outdoor temperature is low and the humidity is high, the heat exchanger on the outdoor unit side tends to collect frost, which reduces its heating performance. To remove the frost, Auto-defrost function will be activated and the heating mode will temporarily stop for 3-10 minutes. Heating mode will automatically resume upon completion of defrost process.
- Air conditioner with a heat pump requires time to warm up the whole room after the heating operation begins, because the system circulates warm air in order to warm up the whole room.
- The sound levels were obtained in an anechoic room. The sound levels during actual operation are usually higher than the simulated values due to ambient noise and echoes. Refer to the section on "SOUND LEVELS" for the measurement location.
- Depending on the operation conditions, the unit generates noise caused by valve actuation, refrigerant flow, and pressure changes even when operating normally. Please consider to avoid location where quietness is required. For BC controller, it is recommended to unit to be installed in places such as ceilings of corridor, restrooms and plant rooms.
- The total capacity of the connected indoor units can be greater than the capacity of the outdoor unit. However, when the connected indoor units operate simultaneously, each unit's capacity may become smaller than the rated capacity.
- When the unit is started up for the first time within 12 hours after power on or after power failure, it performs initial startup operation (capacity control operation) to prevent damage to the compressor. The initial startup operation requires 90 minutes maximum to complete, depending on the operation load.

4-1-5. Relevant equipment

- Use an earth leakage breaker (ELB) with medium sensitivity, and an activation speed of 0.1 second or less.
- Consult your local distributor or a qualified technician when installing an earth leakage breaker.
- If the unit is inverter type, select an earth leakage breaker for handling high harmonic waves and surges.
- Leakage current is generated not only through the air conditioning unit but also through the power wires. Therefore, the leakage current of the main power supply is greater than the total leakage current of each unit. Take into consideration the capacity of the earth leakage breaker or leakage alarm when installing one at the main power supply. To measure the leakage current simply on site, use a measurement tool equipped with a filter, and clamp all the four power wires together. The leakage current measured on the ground wire may not accurate because the leakage current from other systems may be included to the measurement value.
- Do not install a phase advancing capacitor on the unit connected to the same power system with an inverter type unit and its equipment.
- If a large current flows due to the product malfunctions or faulty wiring, both the earth leakage breaker on the product side and the upstream overcurrent breaker may trip almost at the same time. Separate the power system or coordinate all the breakers depending on the system's priority level.

4. Installation information

4-1-6. Unit installation

- Your local distributor or a qualified technician must read the Installation Manual that is provided with each unit carefully before performing installation work.
- Consult your local distributor or a qualified technician when installing the unit. Improper installation by an unqualified person may result in water leakage, electric shock, or fire.
- Ensure there is enough space around each unit.

4-1-7. Optional accessories

- Only use accessories recommended by Mitsubishi Electric. Consult your local distributor or a qualified technician when installing them. Improper installation by an unqualified person may result in water leakage, electric leakage, system breakdown, or fire.
- Some optional accessories may not be compatible with the air conditioning unit to be used or may not be suitable for the installation conditions. Check the compatibility when considering any accessories.
- Note that some optional accessories may affect the air conditioner's external form, appearance, weight, operating sound, and other characteristics.

4-1-8. Operation/Maintenance

- Read the Instruction Book that is provided with each unit carefully prior to use.
- Maintenance or cleaning of each unit may be risky and require expertise. Read the Instruction Book to ensure safety. Consult your local distributor or a qualified technician when special expertise is required such as when the indoor unit needs to be cleaned.

4-2. Precautions for Indoor unit

4-2-1. Operating environment

- The refrigerant (R410A) used for air conditioner is non-toxic and nonflammable. However, if the refrigerant leaks, the oxygen level may drop to harmful levels. If the air conditioner is installed in a small room, measures must be taken to prevent the refrigerant concentration from exceeding the safety limit even if the refrigerant should leak.
- If the units operate in the cooling mode at the humidity above 80%, condensation may collect and drip from the indoor units.

4-2-2. Unit characteristics

- The return air temperature display on the remote controller may differ from the ones on the other thermometers.
- The clock on the remote controller may be displayed with a time lag of approximately one minute every month.
- The temperature using a built-in temperature sensor on the remote controller may differ from the actual room temperature due to the effect of the wall temperature.
- Use a built-in thermostat on the remote controller or a separately-sold thermostat when indoor units installed on or in the ceiling operate the automatic cooling/heating switchover.
- The room temperature may rise drastically due to Thermo OFF in the places where the air conditioning load is large such as computer rooms.
- Be sure to use a regular filter. If an irregular filter is installed, the unit may not operate properly, and the operation noise may increase.
- The room temperature may rise over the preset temperature in the environment where the heating air conditioning load is small.

4-2-3. Unit installation

- The insulation for low pressure pipe between the HBC controller and outdoor unit shall be at least 20 mm thick. If the unit is installed on the top floor or in a high-temperature, high-humidity environment, thicker insulation may be necessary.
- Do not have any branching points on the downstream of the refrigerant pipe header.
- When a field-supplied external thermistor is installed or when a device for the demand control is used, abnormal stop of the unit or damage of the electromagnetic contactor may occur. Consult your local distributor for details.

4. Installation information

4-3. Precautions for Outdoor unit/Heat source unit

4-3-1. Installation environment

- Outdoor unit with salt-resistant specification is recommended to use in a place where it is subject to salt air.
- Even when the unit with salt-resistant specification is used, it is not completely protected against corrosion. Be sure to follow the directions or precautions described in Instructions Book and Installation Manual for installation and maintenance. The salt-resistant specification is referred to the guidelines published by JRAIA (JRA9002).
- Install the unit in a place where the flow of discharge air is not obstructed. If not, the short-cycling of discharge air may occur.
- Provide proper drainage around the unit base, because the condensation may collect and drip from the outdoor units. Provide water-proof protection to the floor when installing the units on the rooftop.
- In a region where snowfall is expected, install the unit so that the outlet faces away from the direction of the wind, and install a snow guard to protect the unit from snow. Install the unit on a base approximately 50 cm higher than the expected snowfall. Close the openings for pipes and wiring, because the ingress of water and small animals may cause equipment damage. If SUS snow guard is used, refer to the Installation Manual that comes with the snow guard and take caution for the installation to avoid the risk of corrosion.
- When the unit is expected to operate continuously for a long period of time at outside air temperatures of below 0°C, take appropriate measures, such as the use of a unit base heater, to prevent icing on the unit base. (Not applicable to the PUMY series)
- Install the snow guard so that the outlet/inlet faces away from the direction of the wind.
- When the snow accumulates approximately 50 cm or more on the snow guard, remove the snow from the guard. Install a roof that is strong enough to withstand snow loads in a place where snow accumulates.
- Provide proper protection around the outdoor units in places such as schools to avoid the risk of injury.
- A cooling tower and heat source water circuit should be a closed circuit that water is not exposed to the atmosphere. When a tank is installed to ensure that the circuit has enough water, minimize the contact with outside air so that the oxygen from being dissolved in the water should be 1 mg/L or less.
- Install a strainer (50 mesh or more recommended) on the water pipe inlet on the heat source unit.
- Interlock the heat source unit and water circuit pump.
- Note the followings to prevent the freeze bursting of pipe when the heat source unit is installed in a place where the ambient temperature can be 0°C or below.
 - Keep the water circulating to prevent it from freezing when the ambient temperature is 0°C or below.
 - Before a long period of non use, be sure to purge the water out of the unit.
- Salt-resistant unit is resistant to salt corrosion, but not salt-proof.

Please note the following when installing and maintaining outdoor units in marine atmosphere.

 1. Install the salt-resistant unit out of direct exposure to sea breeze, and minimize the exposure to salt water mist.
 2. Avoid installing a sun shade over the outdoor unit, so that rain will wash away salt deposits off the unit.
 3. Install the unit horizontally to ensure proper water drainage from the base of the unit. Accumulation of water in the base of the outdoor unit will significantly accelerate corrosion.
 4. Periodically wash salt deposits off the unit, especially when the unit is installed in a coastal area.
 5. Repair all noticeable scratches after installation and during maintenance.
 6. Periodically check the unit, and apply anti-rust agent and replace corroded parts as necessary.

4-3-2. Circulating water

- Follow the guidelines published by JRAIA (JRA-GL02-1994) to check the water quality of the water in the heat source unit regularly.
- A cooling tower and heat source water circuit should be a closed circuit that water is not exposed to the atmosphere. When a tank is installed to ensure that the circuit has enough water, minimize the contact with outside air so that the oxygen from being dissolved in the water should be 1 mg/L or less.

4-3-3. Unit characteristics

- When the Thermo ON and OFF is frequently repeated on the indoor unit, the operation status of outdoor units may become unstable.

4-3-4. Relevant equipment

- Provide grounding in accordance with the local regulations.

4. Installation information

4-4. Precautions for Control-related items

4-4-1. Product specification

- ♦To introduce the MELANS system, a consultation with us is required in advance. Especially to introduce the electricity charge apportioning function or energy-save function, further detailed consultation is required. Consult your local distributor for details.
- ♦Billing calculation for AE-200E/AE-50E/EW-50E/AG-150A/EB-50GU-J/TG-2000A, or the billing calculation unit is unique and based on our original method. (Backup operation is included.) It is not based on the metering method, and do not use it for official business purposes. It is not the method that the amount of electric power consumption (input) by air conditioner is calculated. Note that the electric power consumption by air conditioner is apportioned by using the ratio corresponding to the operation status (output) for each air conditioner (indoor unit) in this method.
- ♦In the apportioned billing function for AE-200E/AE-50E/EW-50E/AG-150A and EB-50GU-J, use separate watt-hour meters for A-control units, K-control units, and packaged air conditioner for City Multi air conditioners. It is recommended to use an individual watt-hour meter for the large-capacity indoor unit (with two or more addresses).
- ♦When using the peak cut function on the AE-200E/AE-50E/EW-50E/AG-150A or EB-50GU-J, note that the control is performed once every minute and it takes time to obtain the effect of the control. Take appropriate measures such as lowering the criterion value. Power consumption may exceed the limits if AE-200E/AE-50E/EW-50E/AG-150A or EB-50GU-J malfunctions or stops. Provide a back-up remedy as necessary.
- ♦The controllers cannot operate while the indoor unit is OFF. (No error)
Turn ON the power to the indoor unit when operating the controllers.
- ♦When using the interlocked control function on the AE-200E/AE-50E/EW-50E/AG-150A/EB-50GU-J/PAC-YG66DCA or PAC-YG63MCA, do not use it for the control for the fire prevention or security. (This function should never be used in the way that would put people's lives at risk.) Provide any methods or circuit that allow ON/OFF operation using an external switch in case of failure.

4-4-2. Installation environment

- ♦The surge protection for the transmission line may be required in areas where lightning strikes frequently occur.
- ♦A receiver for a wireless remote controller may not work properly due to the effect of general lighting. Leave a space of at least 1 m between the general lighting and receiver.
- ♦When the Auto-elevating panel is used and the operation is made by using a wired remote controller, install the wired remote controller to the place where all air conditioners controlled (at least the bottom part of them) can be seen from the wired remote controller. If not, the descending panel may cause damage or injury, and be sure to use a wireless remote controller designed for use with elevating panel (sold separately).
- ♦Install the wired remote controller (switch box) to the place where the following conditions are met.
 - ♦Where installation surface is flat
 - ♦Where the remote controller can detect an accurate room temperature
The temperature sensors that detect a room temperature are installed both on the remote controller and indoor unit. When a room temperature is detected using the sensor on the remote controller, the main remote controller is used to detect a room temperature. In this case, follow the instructions below.
 - ♦ Install the controller in a place where it is not subject to the heat source.
(If the remote controller faces direct sunlight or supply air flow direction, the remote controller cannot detect an accurate room temperature.)
 - ♦ Install the controller in a place where an average room temperature can be detected.
 - ♦ Install the controller in a place where no other wires are present around the temperature sensor.
(If other wires are present, the remote controller cannot detect an accurate room temperature.)
- ♦To prevent unauthorized access, always use a security device such as a VPN router when connecting AE-200E/AE-50E/EW-50E/AG-150A/EB-50GU-J or TG-2000A to the Internet.

DATA BOOK **CMB-WP-V-GA1**
CMB-WP-V-GB1
PEFY-WP-VMS1-E
PEFY-WP-VMA-E
PLFY-WP-VBM-E
PFFY-WP-VLRMM-E



for a greener tomorrow

Eco Changes is the Mitsubishi Electric Group's environmental statement, and expresses the Group's stance on environmental management. Through a wide range of businesses, we are helping contribute to the realization of a sustainable society.

⚠ Warning

Do not use refrigerant other than the type indicated in the manuals provided with the unit and on the nameplate.

- Doing so may cause the unit or pipes to burst, or result in explosion or fire during use, during repair, or at the time of disposal of the unit.
- It may also be in violation of applicable laws.
- MITSUBISHI ELECTRIC CORPORATION cannot be held responsible for malfunctions or accidents resulting from the use of the wrong type of refrigerant.

Our air-conditioning equipments and heat pumps contain a fluorinated greenhouse gas, R410A.

MITSUBISHI ELECTRIC CORPORATION

HEAD OFFICE: TOKYO BLDG., 2-7-3, MARUNOUCHI, CHIYODA-KU, TOKYO 100-8310, JAPAN