

Lossnay Energy Recovery Ventilator

Models:

LGH-15RX₅-E,

LGH-25RX₅-E,

LGH-35RX₅-E

LGH-50RX₅-E,

LGH-65RX₅-E,

LGH-80RX₅-E

LGH-100RX₅-E,

LGH-150RX₅-E,

LGH-200RX₅-E

Installation Instructions

(For use by dealer/contractor)

Models LGH-15RX₅-E to LGH-100RX₅-E

Models LGH-150RX₅-E and LGH-200RX₅-E

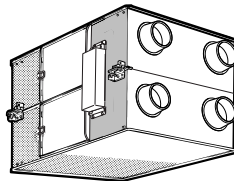
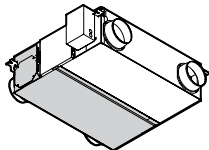

Contents

Safety precautions	1
Outline drawings	2
Standard installation examples	3
Installation method	3
Function settings	10
Trial operation	12

This product needs to be installed properly in order to ensure maximum functionality as well as safety.





Please make sure to read this installation manual before starting the installation.



- Installation must be performed by a dealer or installation contractor. Please note that improper installation may cause malfunction or accident.

Separate booklet "Operating Instructions" is provided for the customer. The booklet and this manual must be handed over to the customer after completing the installation.

Safety precautions

The following signs indicate that death or serious injury may be caused by failure to heed the precautions described below.

 WARNING	
 Do not disassemble	Do not modify or disassemble. (It could cause fire, electric shock or injury.)
 Prohibition of use in bath or shower room	The Lossnay unit and remote controller should not be installed where it is highly humid, like a bathroom, or other wet place. (It could cause electric shock or power leakage.)
 Connect the grounding wire.	Connect the product properly to ground. (Malfunctioning or power leaks can cause electrical shock.)
 The instructions given must be followed.	
<p>Use the specified power supply and voltage. (Use of incorrect power supply or voltage could cause fire or electric shock.)</p> <p>Select a place with sufficient strength and install the main unit securely. (It could cause injury if it falls.)</p> <p>Wiring work must be performed by qualified professionals, and be implemented safely and securely in accordance with the engineering standards and the extension wiring rules for electrical equipment. (Poor connection or improper wiring work could cause electric shock or fire.)</p> <p>Install a power supply isolator at the power supply side as per local electrical regulations. All supply circuits must be disconnected before obtaining access to the terminal devices. Use the specified cable size and connect the cables securely to prevent disconnection when they are pulled. (If there is a defect in the connection, there is a possibility of fire.)</p> <p>Select an adequate place for the opening to introduce outdoor air, where it will not intake the exhaust fumes like combustion gas, or others, and there is no risk of blockage. (Shortage of fresh air could put the room in a state of oxygen deficiency.)</p> <p>A duct made of steel must be installed with care not to be connected electrically with metals such as metal, wire, stainless steel plate, or others. (It could cause fire when power leakage occurs.)</p>	

 CAUTION	
 Prohibited	<p>Do not place a burning appliance in a place where it is exposed directly to the air from the Lossnay unit. (It could cause an accident as a result of incomplete combustion.)</p> <p>Do not use at a place where it is exposed to high temperatures (40°C or higher), naked flames, or in environment with combustible fumes. (It could cause fire.)</p> <p>Do not use in an environment such as a chemical factory, where hazardous gases such as acidic gases, alkaline gases, organic solvent fumes, paint fumes, or gases containing corrosive components are generated. (It could malfunction.)</p> <p>Do not install this product in a place where it is exposed to ultraviolet light. (UV may damage covering insulation.)</p>
 The instructions given must be followed.	
<p>Put on gloves during installation. (It could cause injury.)</p> <p>Make sure the power supply isolator is turned off on the power distribution panel when Lossnay is not used for a long period of time after the installation. (It could cause electric shock, power leakage, or fire as a result of deteriorated insulation.)</p> <p>Always use the specified suspension bolts, nuts and washers or correctly rated wire / chain hangers. (Use of hardware with insufficient strength could result in the product dropping.)</p> <p>The outside ducts must be tilted at a gradient (1/30 or more) down toward the outdoor louvres from Lossnay, and properly insulated. (The entry of rain water may cause power leakage, fire, or damage to household property.)</p> <p>The control box cover must be closed after the installation. (Dust or humidity may cause power leakage or fire.)</p> <p>When connecting external devices (electrically operated damper, lamp, monitoring unit, etc.) using output signals of the Lossnay unit, make sure to install safety equipment for the external devices. (It could cause fire, damage, etc. without safety equipment.)</p>	

CAUTION	
<ul style="list-style-type: none"> • When using the product where it is exposed to high temperatures and humidity (40°C or higher, RH 80% or higher), or where fog occurs frequently, moisture is likely to condense in the core, and may result in condensation build up in the unit. The product should not be used under such conditions. • Outdoor air may enter the Lossnay owing to the pressure difference between indoor and outdoor or external winds even when the product is not operated. It is recommended to install an Electrically operated damper to block the outdoor air. • In a cold weather area, an area with strong external winds or where fog occurs frequently, cold outdoor air, external winds or fog may be introduced into the product when its operation is stopped. It is recommended to install an Electrically operated damper. 	<ul style="list-style-type: none"> • When using the product in an environment where there is a window, or opening near the outdoor louvre, where insects are likely to gather around the interior or exterior light, take note that small insects may intrude into the product. • In a cold weather area, or others, dewing or freezing could occur on the main unit, where the duct is connected, or other sections, depending on the conditions of outdoor air and indoor temperature and moisture, even if they are within the range of operating conditions. Make sure to confirm the operating conditions and other precautions, and do not use the product if dewing or freezing is anticipated. <p><small>*Example of dewing condition - Outdoor air: -5°C or lower, dew-point temperature at installation place: 10°C or higher (When the indoor temperature is 22°C or higher with the relative humidity higher than 50%, or other)</small></p>

Outline drawings

LGH-15 to 100 RX₅

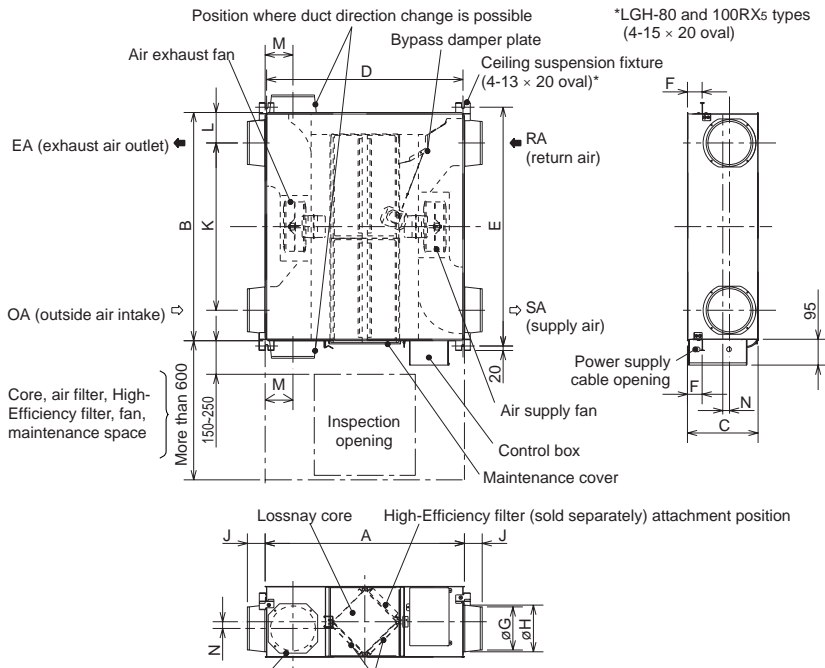

Accessory parts

- Mounting screws x16
- Duct connecting flanges x4 (double flanges at SA and EA sides)
- Slim-Lossnay connection cable (gray: two wires) x1

Position where duct direction change is possible Air filters

Unit (mm)

Model	Dimensions			Ceiling suspension fixture pitch			Nominal diameter	Duct connecting flange			Duct pitch				Weight (kg)
	A	B	C	D	E	F		G	H	J	K	L	M	N	
LGH-15 RX ₅	780	735	273	768	782	65	100	97.5	110	103	530	102.5	102	30	20
LGH-25 RX ₅	780	735	273	768	782	65	150	142	160	63	530	102.5	102	30	20
LGH-35 RX ₅	888	874	315	875	921	80	150	142	160	64	650	112	124	55	29
LGH-50 RX ₅	888	1016	315	875	1063	65	200	192	208	79	745	135.5	124	30	32
LGH-65 RX ₅	908	954	386	895	1001	70	200	192	208	79	692	131	133	-	40
LGH-80 RX ₅	1144	1004	399	1010	1036	389	250	242	258	79	690	157	165	-	53
LGH-100 RX ₅	1144	1231	399	1010	1263	389	250	242	258	79	917	157	165	-	59

LGH-150 and 200 RX₅

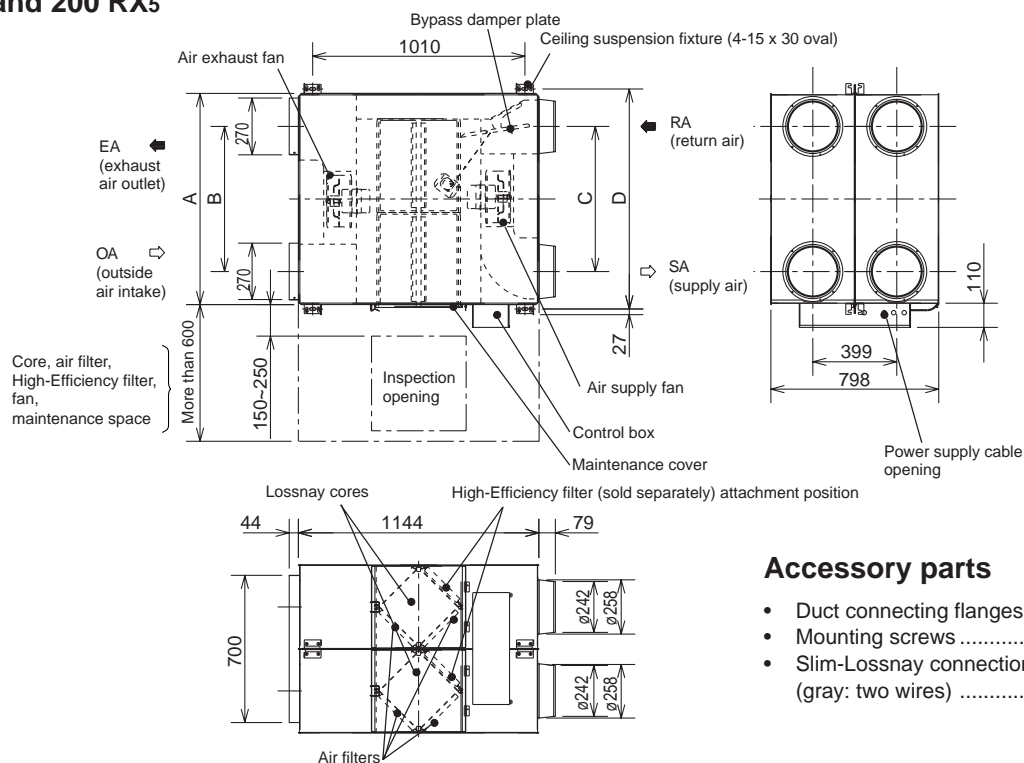

Accessory parts

- Duct connecting flanges x4
- Mounting screws x16
- Slim-Lossnay connection cable (gray: two wires) x1

Unit (mm)

Model	A	B	C	D	Weight (kg)
LGH-150 RX ₅	1004	690	690	1045	105
LGH-200 RX ₅	1231	917	917	1272	118

Standard installation examples

- Duct length

Model	Distance
LGH-15 to 65 RX ₅	1 m or more
LGH-80 and 100 RX ₅	2.5 m or more
LGH- 150 and 200 RX ₅	3 m or more

- **The parts can also be installed upside down.** Remove the maintenance cover, rotate the parts by 180°, and re-install.

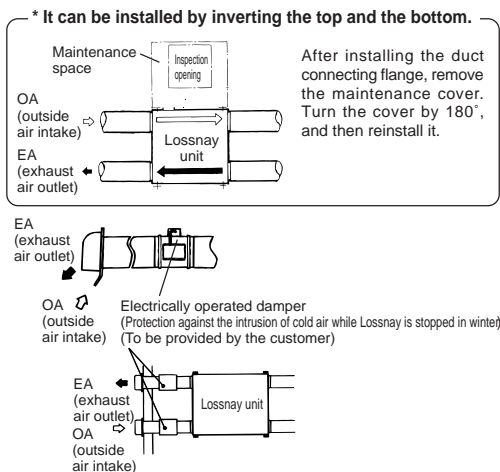

- In a region where there is risk of freezing in winter, it is recommended to install an Electrically operated damper, or the like, in order to prevent the intrusion of (cold) outdoor air while Lossnay is stopped.

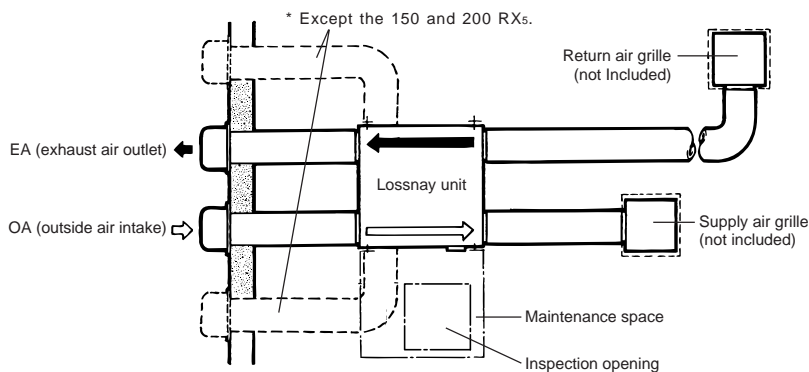

Downward gradient of duct: 1/30 or more (toward wall side) and provision of distance in table below (to prevent rain water from seeping in)

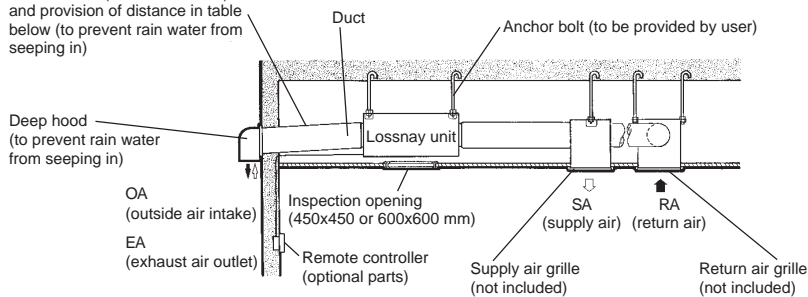

Installation method

Installing the Lossnay unit

1. Preparing the anchor bolts

Mount the washers (outer diameter of >21 mm for M10, >24 mm for M12) and nuts onto the pre-recessed anchor bolts (M10 or M12), as shown in the figure below.

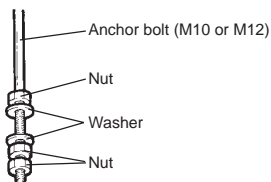

2. Attaching the duct connecting flanges

Use the supplied screws to secure the duct connecting flanges to the Lossnay unit.

Models LGH-15 to 100 RX₅

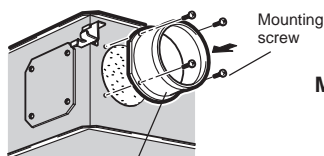

Models LGH-150 and 200 RX₅

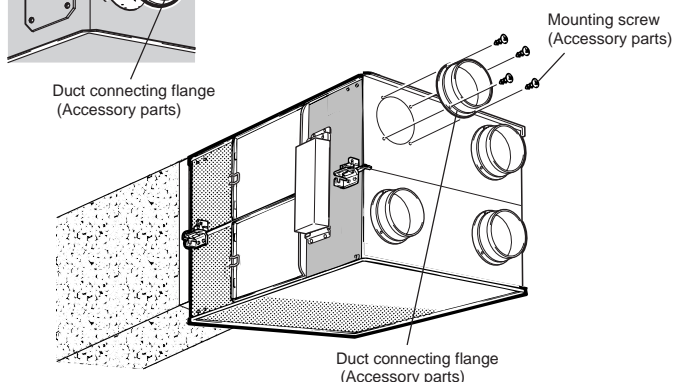

⚠ CAUTION

- Before attaching the duct connecting flanges, check that no foreign matter (scraps of paper, vinyl, etc.) has found its way inside to Lossnay unit.
- Attach the duct connecting flanges with the packing at the SA and RA sides.

3. Mounting Lossnay unit

- (1) Hang the ceiling suspension fixtures on the anchor bolts and adjust in such a way that Lossnay unit is level.
- (2) Tighten up securely using double nuts.

Models LGH-15 to 100 RX₅

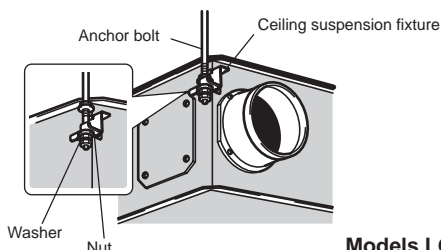

Models LGH-150 and 200 RX₅

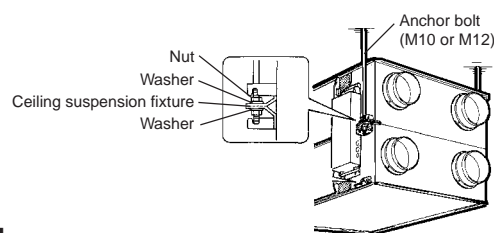

⚠ CAUTION

- When suspending Lossnay unit from the ceiling, do not handle it in such a way that force will be applied to the control box.
- Install the anchor bolts to ensure the product's weight or earthquake load. (Correctly rated wire / chain may also be used)

Installation method (continued)

If the suspension bolts are short, change the mounting hardware.

For the models LGH-80 and 100 RXs

- (1) Remove the suspension fixture and mount it to the upper mounting position.
- (2) Replace screws in the holes for the suspension fixture that has been removed to prevent air leakage.

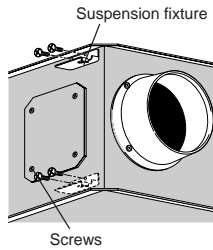

Models LGH-80 and 100 RXs

4. Connecting the ducts

- (1) Fasten the duct securely to the duct connecting flange, and wrap aluminum tape (not included) around the joints so that there is no air leakage.
- (2) Suspend the ducts from the ceiling so that their weight will not be applied to the Lossnay unit.
- (3) The two outdoor ducts must be covered with heat-insulating material in order to prevent condensation from forming.

Models LGH-15 to 100 RXs

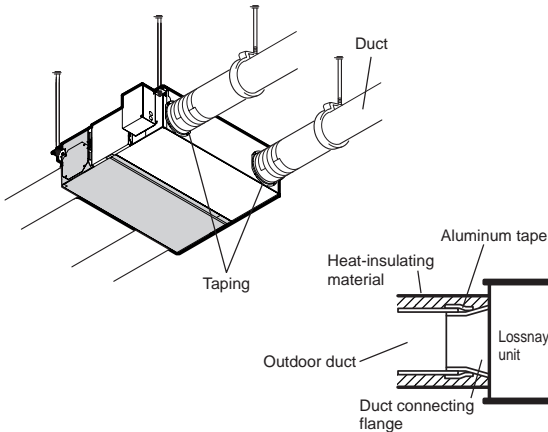

Models LGH-150 and 200 RXs

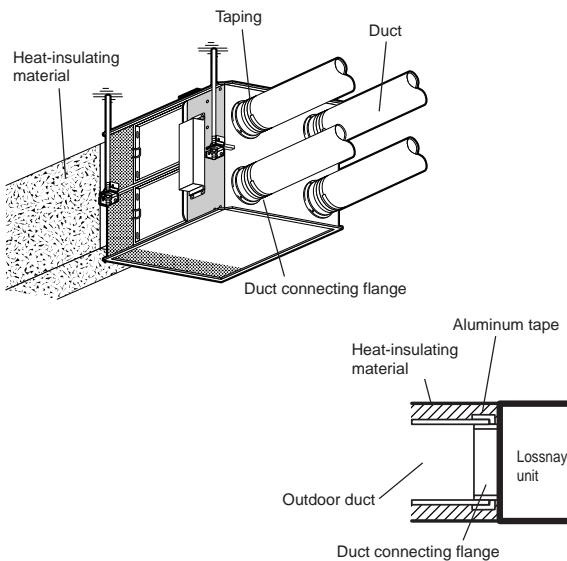

⚠ CAUTION

- Before attaching the ducts, check that no (debris or any other) foreign matter (scraps of paper, vinyl, etc.) has found its way inside the ducts.
- Do not touch the damper plate inside Lossnay unit when connecting the ducts.
- If it is expected that the ambient temperature around the place where the Lossnay unit is installed will be high during the summer air conditioning season, it is recommended that the indoor ductwork be covered with insulation material.

Do not carry out the following types of duct construction. (Doing so could cause a drop in the air volume and generate abnormal noises.)

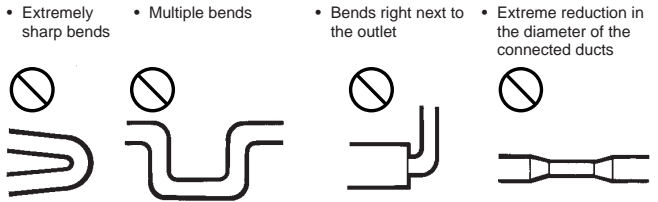

5. When changing the direction of the out door side duct (EA/OA).....Except for LGH-150 and 200 RXs

(1) Removal of flange cover

Unscrewing the flange cover mounting screws (4 pcs), remove the flange cover.

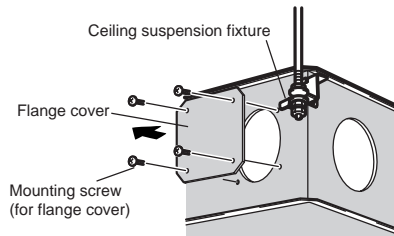

(2) Installation of duct connecting flange

1. Install the duct connecting flange using attached mounting screws.
2. Fix the removed flange cover with the removed mounting screws (4 pcs).

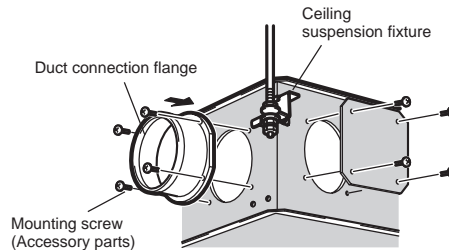

Installation method (continued)

Electrical installation

With this product, the wiring installation method will vary according to the design of the system.

Perform electrical installation to meet local electrical regulations.

* Always use double insulated PVC cable for the transmission cables.

* Wiring work must be performed by qualified professionals.

* All supply circuits must be disconnected before obtaining access to the terminal devices.

Names of components in control box

LGH-15 to 100 RX5

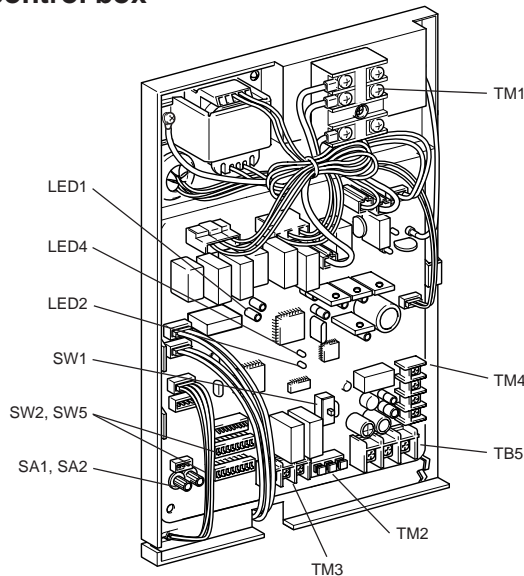

Wire connection diagram

* Connect the wires shown as thick lines.

* Be sure to connect the ground wire.

* A power supply isolator must be installed when wiring power supply to unit.

* Always use a single pole isolator for the main switch power connection.

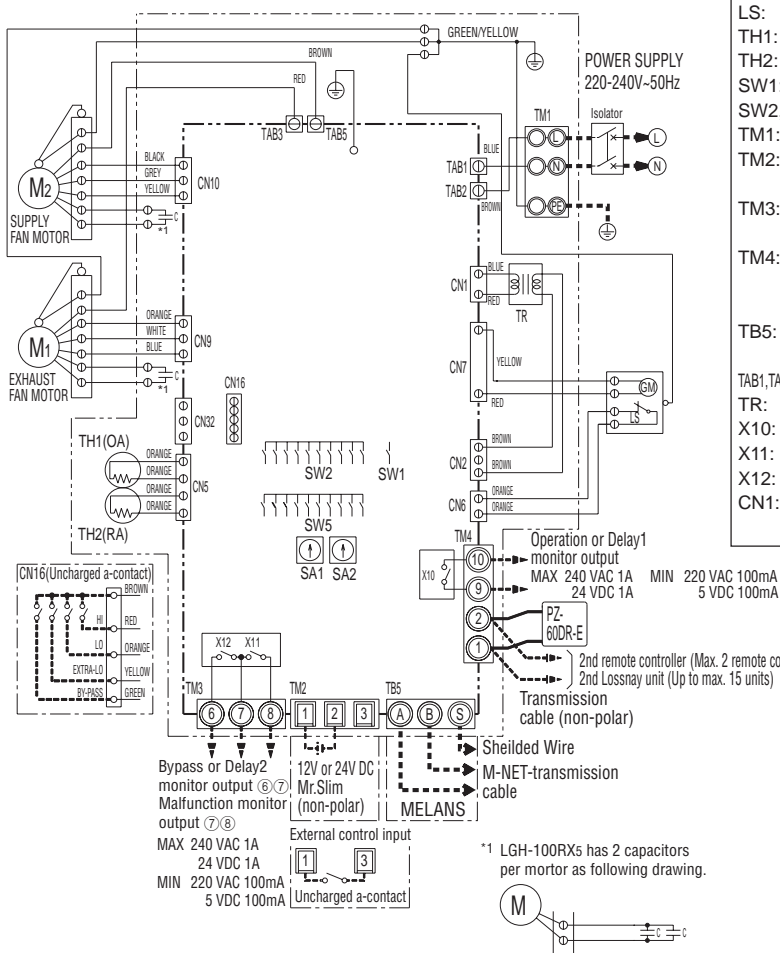

Definition of symbols			
M1:	Motor for exhaust fan	CN2:	Connector (Transformer secondary)
M2:	Motor for supply fan	CN5:	Connector (Thermistor)
C:	Capacitor	CN6:	Connector (Microswitch)
GM:	Motor for Bypass movement	CN7:	Connector (Motor for bypass operation)
LS:	Microswitch	TAB3:	Tab connector (Fan motor)
TH1:	Thermistor for outside air	TAB5:	Tab connector (Fan motor)
TH2:	Thermistor for return air	CN9:	Connector (Fan motor)
SW1:	Switch (Main/sub change)	CN10:	Connector (Fan motor)
SW2,5:	Switch (Function selection)	CN16:	Connector (High/Low/Extra Low/BY-PASS switch)
TM1:	Terminal block (Power supply)	CN32:	Connector (Remote control selection)
TM2:	Terminal block (External control input)	SA1:	Address setting rotary switch (10 digit)
TM3:	Terminal block (Monitor output)	SA2:	Address setting rotary switch (1 digit)
TM4:	Terminal block (Transmission cable and monitor output)	LED1:	Inspection indicator lamp
TB5:	Terminal block (M-NET Transmission cable)	LED2:	Inspection indicator lamp
TAB1, TAB2:	Connector (Power supply)	LED4:	Power supply indicator lamp
TR:	Control circuit transformer	SYMBOL	Terminal block
X10:	Relay contact	⊕	Connector
X11:	Relay contact	Ⓜ	Board insertion connector or fastening connector of control board.
X12:	Relay contact		
CN1:	Connector (Transformer primary)		

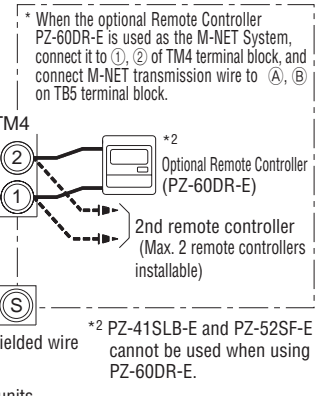

Installation method (continued)

Wire connection diagram ----- Models LGH-150 and 200 RX5

- * Connect the wires shown as thick lines.
- * Be sure to connect the ground wire.
- * A power supply isolator must be installed when wiring power supply to unit.
- * Always use a single pole isolator for the main switch power connection.

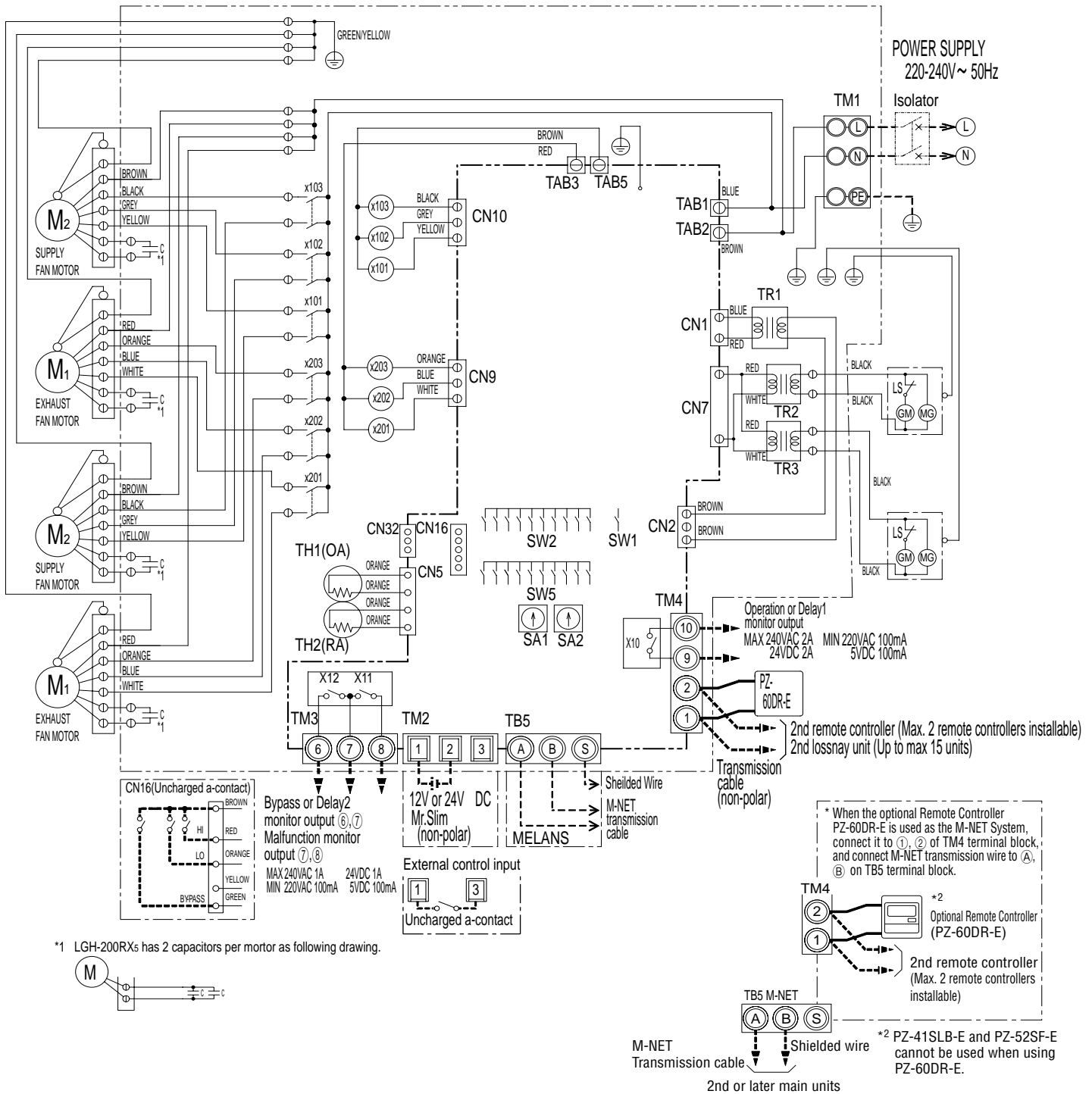

*1 LGH-200RX5 has 2 capacitors per motor as following drawing.

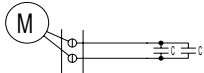

Definition of symbols

M1 : Motor for exhaust fan	TM4: Terminal block (Transmission cable and monitor output)	X201,X202,X203 : Relay Exhaust fan speed control	CN32: Connector (Remote control selection)
M2 : Motor for supply fan	TB5: Terminal block (M-NET Transmission cable)	CN1: Connector(Transformer primary)	SA1: Address setting rotary switch (10 digit)
C : Capacitor	TAB1,TAB2: Connector(Power supply)	CN2: Connector(Transformer secondary)	SA2: Address setting rotary switch (1 digit)
GM : Motor for Bypass movement	TR1: Control circuit transformer	CN5: Connector(Thermistor)	SYMBOL ○ □ : Terminal block
LS : Microswitch	TR2,TR3: Bypass movement transformer	CN7: Connector(Motor for Bypass operation)	⊕ : Connector
TH1: Thermistor for outside air	X10,X11,X12 : Relay contact	TAB3: Tab connector(Fan motor)	Ⓜ : Board insertion connector or fastening connector of control board.
TH2: Thermistor for return air	X101,X102,X103: Relay Supply fan speed control	TAB5: Tab connector(Fan motor)	
SW1: Switch(Main/sub change)		CN9: Connector(Fan motor)	
SW2,5: Switch(Function selection)		CN10: Connector(Fan motor)	
TM1: Terminal block(Power supply)		CN16: Connector(High/Low/BY-PASS switch)	
TM2: Terminal block (External control input)			
TM3: Terminal block(Monitor output)			

Installation method (continued)

Connecting the power supply cable

1. Remove the screws and the control box cover

LGH-15 to 100 RX_s

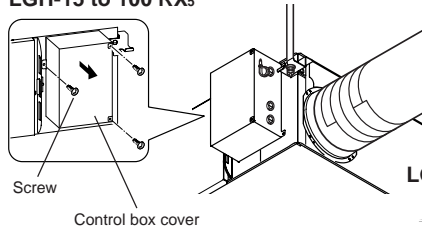

LGH-150 and 200 RX_s

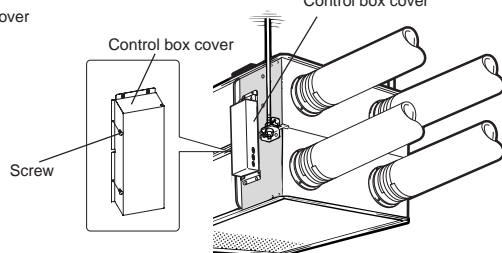

2. Connecting the power supply cable and transmission cable

Pass the power cable through the bush* and connect to the TM1 terminal block using the round terminals. Connect the ground wire to the ground terminal and secure tightening the bush. (*: for PG connector or the like)

LGH-15 to 100 RX_s

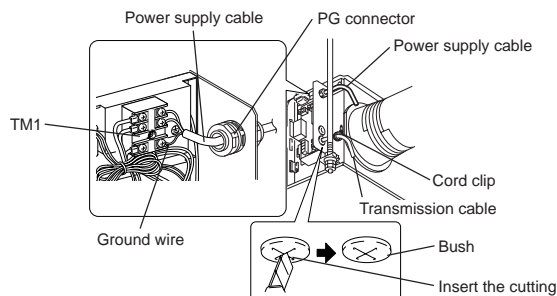

LGH-150 and 200 RX_s

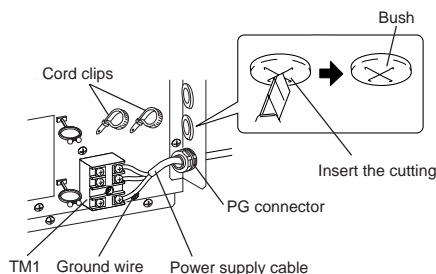

⚠ CAUTION

- Always separate the power supply cable and transmission cable by 5 cm or more to prevent malfunctioning of the unit.
- If the length of the stripped power cables wires is too long, the conductors may touch and short out.
- Power supply cable size : 1.5mm² or more.

(1) Tighten the ground wire and transmission cables to the terminal block.

(2) Secure the transmission cables using the cord clips.

Upon completion of the wiring connections, replace the control box cover.

The following system configuration can be created. Connect the necessary parts.

- 1 When connecting with remote controller (PZ-60DR-E, PZ-41SLB-E).
- 2 When interlocked with indoor unit of air conditioner or other external device including other manufactures.
- 3 When interlocking with a pulse output device.
- 4 When operating multiple Lossnay units.
- 5 When take malfunction monitor output, or take Bypass operation monitor output.
- 6 When connect to an Electrically operated damper, or take operation monitor output.
- 7 When switching High / Low / Extra-Low speed externally (when CO₂ sensor or other device is connected).
- 8 When switching Bypass externally.
- 9 When using the remote/local switching and the ON/OFF input (level signal)
- 10 When connecting to the City Multi, Lossnay remote controller (PZ-52SF-E) or Mitsubishi Electric Air-Conditioner Network System (MELANS).

⚠ CAUTION

- When connecting external devices (electrically operated damper, lamp, monitoring unit, etc.) using output signals of the Lossnay unit, make sure to install safety equipment for the external devices. (It could cause fire, damage, etc. without safety equipment.)

1 When connecting with remote controller (PZ-60DR-E, PZ-41SLB-E)

- * When controlling Lossnay units with the central control, connect wires according to 10.

Securely connect the transmission cable (PVC insulated PVC jacketed and either between ϕ 0.65 and ϕ 1.2, or between 0.3 mm² and 1.25 mm² in cross section) from the remote controller to ① and ② of the input terminal block (TM4). (No polarity)

- If there are two remote controllers, connect them in the same way.

Note

- Don't tighten screws of terminal block with a torque larger than 0.5 Nm. It could damage the PCB.
- Number of transmission wires which can be connected to single input terminal is up to 4 wires for ϕ 0.65 PVC wire or 0.3 mm² stranded wire. It is up to 2 wires for any other wires.
- PZ-41SLB-E cannot be used when MELANS centralized control of the Lossnay is used.
- PZ-60DR-E and PZ-41SLB-E cannot be installed simultaneously.

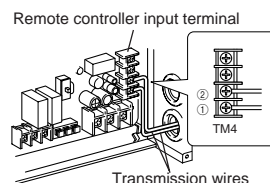
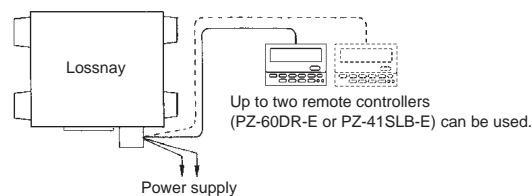

2 When interlocked with indoor unit of air conditioner or other external device including other manufactures

- (1) Connect the output signal cable from the external device to the input terminal block (TM2) of the external controller.

⚠ CAUTION

- The connection may vary according to the output signal type of the external unit.
- Don't tighten screws of terminal block with a torque larger than 0.5 Nm. It could damage the PCB.

Installation method (continued)

- (2) Confirm that the pulse input switch (SW2-2) is set to "OFF".
(Set to "OFF" at time of shipment.)

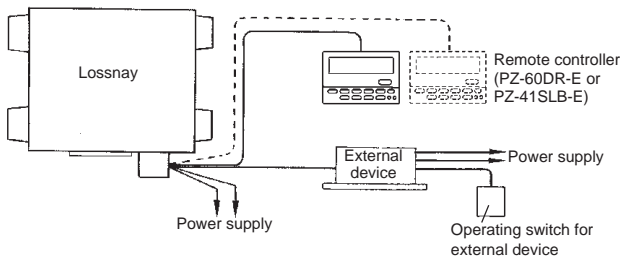

When using Mitsubishi Mr. Slim air conditioner with MA Remote controller

Connect the interlocking cable connector side to CN2L on the circuit board for the indoor Mr. Slim unit, then connect the lead wire side to the ① and ② of the input terminal block (TM2) for the Lossnay external controller input. (No polarity)

- Always separate the power supply cable and the Slim-Lossnay connection cable by 5 cm or more to prevent the unit from malfunctioning.
- The Slim-Lossnay connection cable is 0.25 m long. When wiring, extend it as far as necessary.

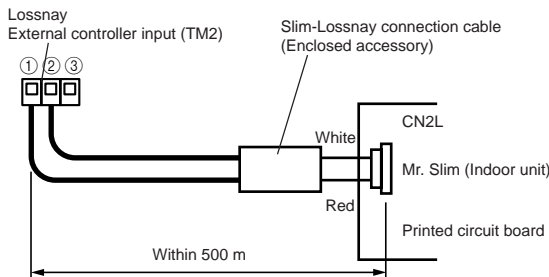

Note

- The Lossnay remote controller (PZ-60DR-E, PZ-41SLB-E) cannot be used with this system.
- Use MA remote controller of Mr. Slim for switching Lossnay ON/OFF or the fan speed.
- The ventilation mode is "automatic ventilation".
- The Slim-Lossnay connection cable may be extended to a maximum length of 500m. (Extension cable specifications are as detailed below)
Ensure that all connections are secure and that the appropriate insulation is provided.
Use extension cable sheathed PVC cable or cable 0.5 mm² to 1.0 mm².

When the external device has a charged operating signal of 12 VDC or 24 VDC

- Connect the operating signal (wire) from the external device via the remote output to ① and ② on the external control input terminal block (TM2). (No polarity)

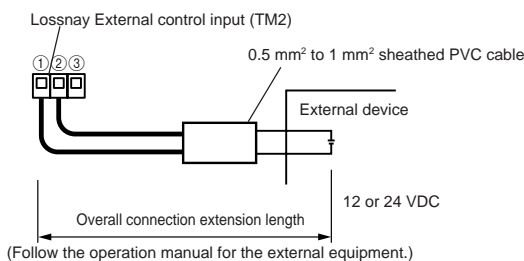

When the external device has an uncharged a-contact signal

- Connect the operating signal (wire) from the external device via the remote output to ① and ③ on the external control input terminal block (TM2).

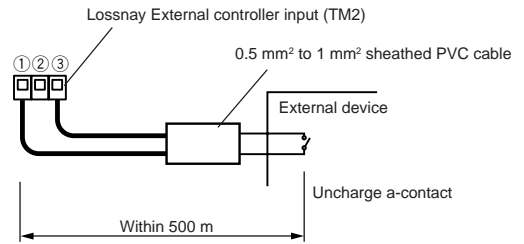

CAUTION

- If an optocoupler or any other type of polar coupler is used at the uncharged a-contact, connect the positive side to ③ and the negative side to ①.

3 When interlocking with a pulse output device

- Move the pulse input switch [SW2-2] to the ON position. (Refer to function settings 1 "Settings for pulse input".)
- Connect the pulse output device (i.e., building management system) to the external control input terminal block [TM2].
 - A pulse width of at least 200 msec will be needed.
 - When using PZ-60DR-E, it can be set also from the remote controller.

Connecting methods vary depending on the types of pulse signal

Refer to Section 2 "When the external device has a charged operation signal of 12 VDC or 24 VDC" or "When the external device has an uncharged a-contact signal".

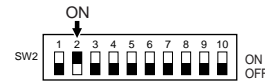

4 When operating multiple Lossnay units

- Connect from Lossnay Unit 1 to Lossnay Unit 2, and from Unit 2 to Unit 3 and so on up to a maximum of 15 units using a transmission cable (PVC insulated PVC jacketed and either between ϕ 0.65 and ϕ 1.2, or between 0.3 mm² and 1.25 mm² in cross section).
- Change the setting on the main/sub switch (SW1) on the second and subsequent Lossnay units to "Sub".

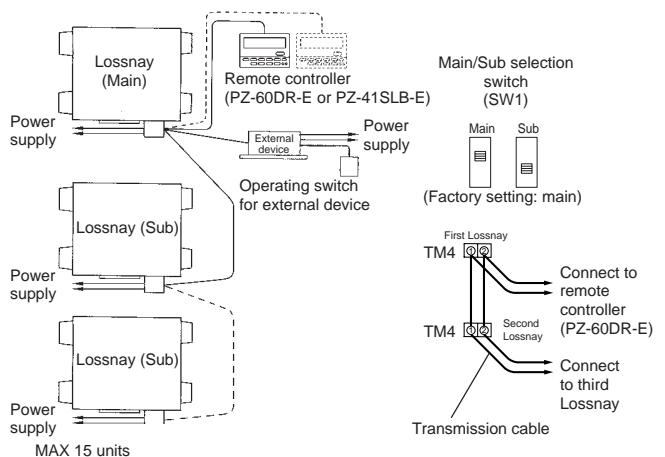

CAUTION

Don't tighten screws of terminal block with a torque larger than 0.5 Nm. It could damage the PCB.

Note

- Up to four 0.3 mm² stranded wires or ϕ 0.65 PVC wires can be connected to one input terminal.
- For other types of wire, up to two can be connected.
- The operation signal and pulse signal can be connected to the external device of the main Lossnay only.
- Connect the power to each respective Lossnay unit.
- When the LGH-150RX_s and LGH-200RX_s types are connected, they operate at low fan speed even if extra low fan speed is selected.

Installation method (continued)

5 When take Malfunction monitor output, or take Bypass operation monitor output.

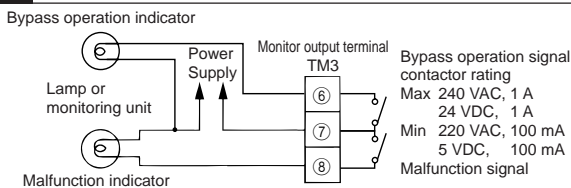

Connect to ⑥ and ⑦, or ⑦ and ⑧ of the monitor output terminal block (TM3) with reference to the wire connection diagram.

Note

* Don't tighten screws of terminal block with a torque larger than 0.5Nm. It could damage the PCB.

Bypass or Delay 2 monitor output with delay function 2 can be possible. (Refer to function settings 18 "Setting for TM3 ⑥⑦")

6 When connect to an Electrically operated damper, or take Operation monitor output

Connect the power supply cable from the Electrically operated damper to ⑨ and ⑩ of the monitor output terminal block (TM4) with reference to the wire connection diagram.

Operation monitor output with delay function 1 can be possible. (Refer to function settings 6 "Setting for TM4 ⑨⑩")

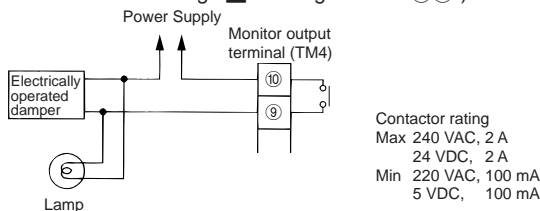

Note

* Don't tighten screws of terminal block with a torque larger than 0.5Nm. It could damage the PCB.

* Response times to external input signals are as shown in the following table.

External Signal	Response Time
Level Signal	Max. 7 sec.
Pulse Signal	Max. 200 msec

7 When switching High/Low/Extra-Low fan speed externally (when CO₂ sensor or other equipment is connected)

Using marketed CO₂ sensor, etc., make connection by inserting the optional remote ON/OFF adaptor (PAC-SA88HA-E) in the connector CN16 (High/Low selector) as shown by the figure.

To force High fan speed externally

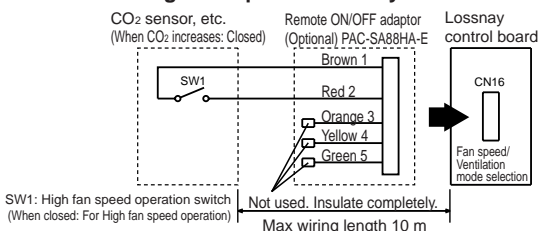

When SW1 is "ON", fan speed of the Lossnay will be set to "High"(Extra-High) regardless of the remote control setting.

Use this in such a way that it ventilates at Low or Extra-Low fan speed normally, and when the external sensor detects contamination of indoor air, it changes to High (Extra High) fan speed operation.

To force Low fan speed externally

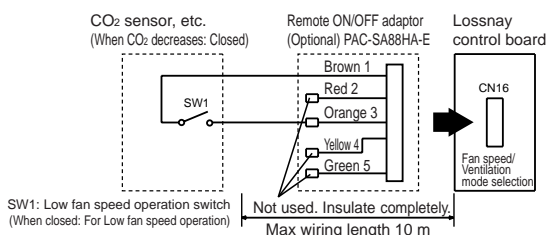

When SW1 is "ON", fan speed of the Lossnay will be set to "Low" regardless of the remote control setting.

Use this in such a way that it ventilates at High fan speed normally, and when the external sensor detect that the indoor air contamination is low, it changes to Low fan speed operation.

To force Extra-Low fan speed externally

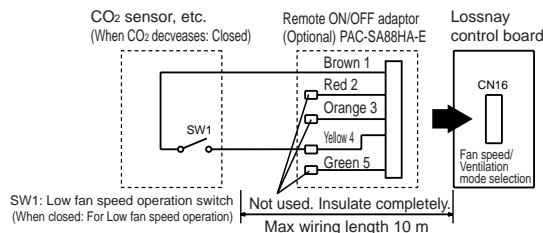

When SW1 is "ON", fan speed of the Lossnay will be set to "Extra-Low" regardless of the remote control setting.

Use this in such a way that it ventilates at High fan speed normally, and when the external sensor detects that the indoor air contamination is low, it changes to Extra-Low fan speed operation.

* For the LGH-150RX_s and LGH-200RX_s types, fan speed of the Lossnay will be "Low".

8 When switching Bypass externally.

Establish the wire connection by inserting the optional remote ON/OFF adaptor (PAC-SA88HA-E) in the connector CN16 (Ventilation mode selector).

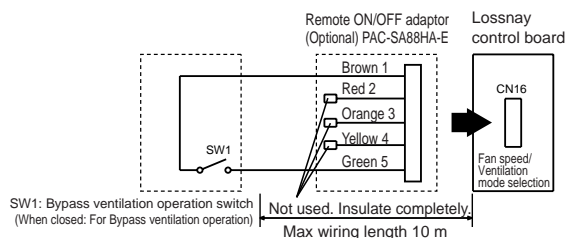

With SW1 is "ON", the ventilation mode of Lossnay is changed to the Bypass ventilation regardless of the setting on the remote controller.

* When the outdoor air temperature drops lower than 8°C, it changes to the heat exchanger ventilation. (Display of the remote controller does not change.)

9 When using the remote/local switching and the ON/OFF input (level signal)

The remote controller (PZ-41SLB-E) cannot be used. Insert the optional remote ON/OFF adaptor (PAC-SE55RA-E) in CN32 on the Lossnay control PCB.

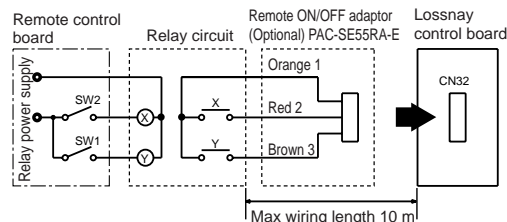

SW1: When this is ON, Lossnay cannot turn ON/OFF by the Remote Controller (PZ-60DR-E, PZ-52SF-E).

SW2: When SW1 is ON, Lossnay can be turned ON by setting SW2 at ON or turned OFF by setting SW2 at OFF.

SW1: Remote/local selector switch

SW2: ON/OFF switch

X, Y : Relay (Contactor rating DC 1 mA)

10 When connecting to the City Multi, Lossnay remote controller (PZ-52SF-E) or Mitsubishi Electric Air-Conditioner Network System (MELANS)

* If centralized control is performed according the wire connection shown in this section, the remote controller (PZ-41SLB-E) cannot be used.

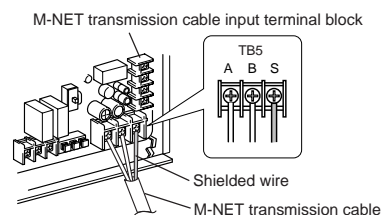

Installation method (continued)

- One shielded wire is connected to TB5 ⑤ on the PCB on terminal. Address setting is required. (Refer to function setting section.)

M-NET transmission cable: Connect any of the City Multi indoor unit, or Mitsubishi Electric Air-Conditioner Network System (MELANS) - to the Lossnay.

- Connecting positions are different for the Remote Controller PZ-60DR-E and PZ-52SF-E.

PZ-60DR-E:

Connect to TM4 ①, ② on the PCB. (See Section 1 “When connecting with Remote Controller (PZ-60DR-E)”.)

PZ-52SF-E:

Connect to TB5 ④, ⑤ on the same terminal block as for the M-NET transmission wires.

- Securely connect the M-NET transmission wires to TB5 ④, ⑤. (No-Polar)
Type: (Shielded wire, CVVS/CPEVS)
Wire diameter: 1.25 mm² to 2.0 mm²

CAUTION

- Don't tighten screws on the terminal block with a torque larger than 0.5 Nm. It may damage the PCB.
- Always use shielded wires only for the M-NET transmission wires, and finish the shield properly.

Function settings

Address setting is required when connecting to City Multi, Lossnay remote controller (PZ-52SF-E) and MELANS.

Setting the address

Use the following procedure when setting the address for dedicated Lossnay.

(The method in determining the addresses will depend on the existing system. Refer to the appropriate technical documents for details.)

- (1) Remove the control box cover.
- (2) Use a flatblade screwdriver to turn the address setting switch on the circuit board.
 - SA1 indicates the 10 digit and SA2 indicates the 1 digit.
 - The factory setting is "00"

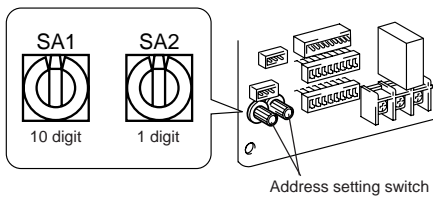

- * When the address number has been changed, the data in the memory is automatically reset.

Changing the function selection switches (SW-2 and 5)

Set the selection switches (SW-2 and 5) to perform the appropriate function.

- * The function marked (*) above can be set also from the remote controller (PZ-60DR-E). If the function is switched later using the remote controller, it operates according to the setting on the remote controller.

When interlocking with Mitsubishi Free Plan air conditioner

- In case of PZ-60DR-E

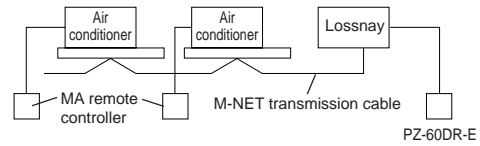

- In case of PZ-52SF-E

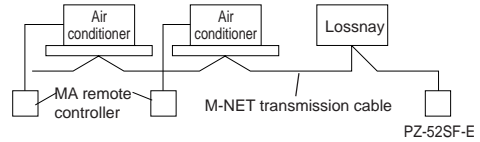

When connecting to PZ-60DR-E and MELANS

- Connect the power feeding unit.

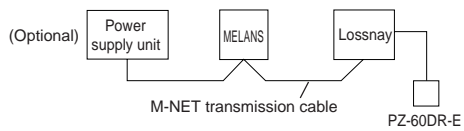

- * Limit the total length of transmission wires no longer than 500 m. Limit the wiring length between Lossnay and the power supply unit (Optional) or the outdoor unit no longer than 200 m.

(SW2)	
1	Trial operation
2	Pulse input setting *
3	Power supply/exhaust when operation starts *
4	SA fan fixed at Low speed *
5	EA fan fixed at Low speed *
6	Power supply ON/OFF *
7	Bypass ventilation priority at Automatic mode *
8	Setting for TM4 ⑨⑩ output
9	Supply Extra High/High *
10	Exhaust Extra High/High *
(SW5)	
1	Delay setting *
2	Operation monitor output *
3	Exhaust fan stop during defrosting *
4	Exhaust fan at Low speed at outdoor air lower than -15°C *
5	Auto restoration after power failure *
6	Filter maintenance indication setting *
7	Setting for TM3 ⑥⑦ output
8	} Interlock mode setting *
9	
10	Not used OFF: LGH-15 to 100RX _s ON : LGH-150 and 200RX _s

- Settings for pulse input
- Switching to power supply/exhaust when operation starts
- Switching to the multi ventilation mode
- Power supply ON/OFF function (cannot be set when PZ-41SLB-E is used)
- Bypass automatic ventilation priority setting *
- Setting for TM4 ⑨⑩ output
- Extra High/High switch setting
- Set for delay operation at heating or cooling start-up
- Operation output monitor
- Exhaust fan stop during defrosting, exhaust fan Low speed operation at outdoor air lower than -15°C
- Settings for automatic recovery following power supply interruption (cannot be set when PZ-41SLB-E is used)
- Settings for filter cleaning (cannot be set when PZ-41SLB-E is used)
- Setting for TM3 ⑥⑦ output
- Settings for interlock mode
- Exhaust fan stop at outdoor air lower than -15°C *

Function settings (continued)

1 Settings for pulse input

Set as shown when connecting the pulse signal equipment from a building maintenance system to an external input.

	OFF	ON	Mode
SW2	2	<input checked="" type="checkbox"/>	No pulse input (factory setting)
	2	<input type="checkbox"/>	Pulse input

2 Switching to power supply/exhaust when operation starts

This sets the fan to run forcibly for 30 minutes when operation starts to ventilate the indoor area. After 30 minutes, the system switches to enable fan speed adjustment from the remote controller. Use this setting if the indoor air is contaminated at night when the system is shut down and you desire to ventilate the indoor area quickly when operation is started in the morning.

	OFF	ON	Operation
SW2	3	<input checked="" type="checkbox"/>	Normal (factory setting)
	3	<input type="checkbox"/>	Runs the fan forcibly for 30 minutes when operation starts.

3 Switching to the multi ventilation mode

This sets the ventilation system to in the case that ventilation balance in accordance with the use environment and installation location is selected. There are four possible setting modes.

	OFF	ON	Mode	Operation
SW2	4	<input checked="" type="checkbox"/>	Power Ventilation Normal (factory setting)	The fan speed alternates between the High (Extra high) and Low instead of the remote controller setting.
	4	<input type="checkbox"/>	Power Supply	Runs the exhaust fan (EA) at Low speed constantly. Alternates the supply fan (SA) speed between the High (Extra high) and Low.
	4	<input checked="" type="checkbox"/>	Power Exhaust	Runs the supply fan (SA) at Low speed constantly. Alternates the exhaust fan (EA) speed between the High (Extra high) and Low.
	4	<input type="checkbox"/>	Power Save Ventilation	Runs the supply fan (SA) and exhaust fan (EA) at Low speed constantly. Switches to the Power Save Ventilation setting regardless of the remote controller's High or Low.

* When using the Remote Controller (PZ-60DR-E), operation of the Extra Low fan speed button initiates the Extra Low fan speed operation both at the supply (SA) and exhaust (EA) sides. Independent operation of the supply (SA) or exhaust (EA) side is prohibited when it is set at the Extra Low fan speed.

4 Power supply ON/OFF function (cannot be set when PZ-41SLB-E is used)

Controls stop and start operation by turning the power supply (220-240 V) for the Lossnay on and off.

	OFF	ON	Mode	Operation
SW2	6	<input checked="" type="checkbox"/>	Off (factory setting)	Stop and start is performed according to SW5-4 settings when the power is on.
	6	<input type="checkbox"/>	On	Operation possible by turning power on and off.

5 Bypass automatic ventilation priority setting

Two thermistors in the Lossnay unit detect the indoor (RA) and outdoor (OA) air temperatures and automatically select the "Lossnay ventilation" or "Bypass ventilation". With this mode, however, priority is given to the "Bypass ventilation".

* This setting reflects to the night purge operation condition.

	OFF	ON	Operation
SW2	7	<input checked="" type="checkbox"/>	When outdoor temperature (OA) is 28°C or higher within 24 hours, then Bypass ventilation starts by the comparison OA and RA temperature. The lowest RA temperature of Bypass operation is 24°C (factory setting) When the night purge is set by the remote controller PZ-60DR-E, night purge operation starts at a temperature of 28°C (within 24 hours).
	7	<input type="checkbox"/>	When outdoor temperature (OA) is 17°C or higher within 24 hours, then Bypass ventilation starts by the comparison OA and RA temperature. The lowest RA temperature of Bypass operation is 19°C When the night purge is set by the remote controller PZ-60DR-E, night purge operation starts at a temperature of 17°C (within 24 hours).

6 Setting for TM4 ⑨⑩ output

	OFF	ON	Operation
SW2	8	<input checked="" type="checkbox"/>	Operation monitor output Corresponds to operation mode output (TM4 ⑨⑩) based on SW5-2 setting. (factory setting)
	8	<input type="checkbox"/>	Operation monitor output with delay function 1 Corresponds to operation mode output (TM4 ⑨⑩) supply fan with following function. <ul style="list-style-type: none"> Starts the output (TM4 ⑨⑩) 10 seconds after supply fan operates. Lossnay continues to operate for 3minutes after stopping the output (TM4 ⑨⑩) Caution : Fan may be operating after turn off the switch of the remote controller.

7 Extra High/High switch setting

Select this function when increased air volume is required or when the duct piping is longer.

	OFF	ON	Operation
SW2	9	<input checked="" type="checkbox"/>	Supply fan (SA) - High fixed (factory setting)
	9	<input type="checkbox"/>	Supply fan (SA) - Extra High fixed
	10	<input checked="" type="checkbox"/>	Exhaust fan (EA) - High fixed (factory setting)
	10	<input type="checkbox"/>	Exhaust fan (EA) - Extra High fixed

8 Set for delay operation at heating or cooling start-up

Delays Lossnay operation for 30 minutes when City Multi or Mr. Slim starts operating or when an external device starts operating. (If the PZ-41SLB-E is used, set it at the remote control.)

	OFF	ON	Mode
SW5	1	<input checked="" type="checkbox"/>	No operation delay (factory setting)
	1	<input type="checkbox"/>	Operation delay of 30 minutes * This function is invalid with in 2 hours' restart

9 Operation output monitor

This setting is available when SW2-8 is OFF.

	OFF	ON	Mode
SW5	2	<input checked="" type="checkbox"/>	Corresponds to operation mode output (TM4 ⑨⑩) exhaust fan (factory setting)
	2	<input type="checkbox"/>	Corresponds to operation mode output (TM4 ⑨⑩) supply fan (The operation monitor output is off when the supply fan is stopped for operation in cold regions or during the City Multi or Mr. Slim defrost mode.)

Function settings (continued)

10 Exhaust fan stop during defrosting, exhaust fan Low speed operation at outdoor air lower than -15°C

Sets the operation of the exhaust fan (when the air supply fan is stopped) during defrosting of the air conditioner when Mr. Slim or City Multi indoor unit is connected to a duct.

When the outdoor air is lower than -15°C, stop the operation of exhaust fan. (OA stop operation at cold region)

	OFF	ON	Operation
SW5	3	<input checked="" type="checkbox"/>	Exhaust fan operation (factory setting)
	3	<input type="checkbox"/>	Exhaust fan stop, exhaust fan operation at Low speed at outdoor air lower than -15°C

11 Settings for automatic recovery following power supply interruption (cannot be set when PZ-41SLB-E is used)

Sets for automatic recovery following power supply interruption.

	OFF	ON	Mode	Operation
SW5	4	<input checked="" type="checkbox"/>	No automatic recovery (factory setting)	Stop after recovery
	4	<input type="checkbox"/>	Automatic recovery	Recover to operate in mode used before power outage

12 Settings for filter cleaning (cannot be set when PZ-41SLB-E is used)

Set the schedule for filter cleaning based on the estimated concentration of dust in the air. Factory setting is unlimited.

* When using PZ-60DR-E, it is also possible to indicate the cleaning cycle of filter (3,000 hours).

	OFF	ON	Maintenance time
SW5	5	<input checked="" type="checkbox"/>	Unlimited (No "FILTER" display on remote controller) (factory setting)
	5	<input type="checkbox"/>	3000 hours

⚠ CAUTION

- When the setting for the cumulative operation time of the Lossnay is exceeded, the filter cleaning display will appear on the indoor unit remote controller or the Lossnay remote controller. After cleaning the filter, the filter cleaning display can be reset. Refer to the operating instructions for the remote controller.

13 Setting for TM3 ⑥⑦ output

	OFF	ON	Operation
SW5	6	<input checked="" type="checkbox"/>	Bypass ventilation operation monitor output. Corresponds to operation mode output (TM3 ⑥⑦) of bypass damper. (factory setting)
	6	<input type="checkbox"/>	Operation monitor output with delay function 2. Corresponds to operation mode output (TM3 ⑥⑦) supply fan with following function. <ul style="list-style-type: none"> Start the output (TM3 ⑥⑦) 10 seconds after supply fan operates but also when the thermistor for outside air (TH1) detects -5°C or lower. Stop the output (TM3 ⑥⑦), when thermistor for outside air (TH1) detects a temperature higher than 15°C or stop the supply fan or malfunction of TH1. Lossnay continues to operate for 3 minutes, after stopping the output (TM3 ⑥⑦) Error code is shown on the remote controller and stop the output in case of followings. <ol style="list-style-type: none"> TH1 detects higher than 15°C within 15 minutes after the output starts. TH1 detects -10°C or lower, 60 minutes after the output starts. TH1 detects continuously 70°C or higher for more than 1 minute. Caution: Fan may be operating after turn off the switch of the remote controller.

14 Settings for interlock mode

These settings indicate how Lossnay should operate when external devices are started or stopped. (If the PZ-41SLB-E is used, set it at the remote control.)

	OFF	ON	Mode	Operation
SW5	7	<input checked="" type="checkbox"/>	On/Off interlock (factory setting)	The Lossnay will start and stop according to the operation of the external devices. Subsequent operation will be possible using the remote controller for the Lossnay or MELANS.
	7	<input type="checkbox"/>	On interlock	The Lossnay will operate whenever external devices are operated. Lossnay stop operation will be possible using its remote controller or MELANS.
	7	<input checked="" type="checkbox"/>	Off operation	The Lossnay will stop whenever external devices are stopped. Lossnay start operation will be possible using its remote controller or MELANS.
	7	<input type="checkbox"/>	External input given priority	The Lossnay will start and stop according to the operation of the external devices. Control via the Lossnay remote controller or MELANS will only be possible when external devices are stopped.

15 Exhaust fan stop at outdoor air lower than -15°C

Set the exhaust fan operation when the outdoor air is lower than -15°C. (Suction stop operation at cold region)

	OFF	ON	Operation
SW5	9	<input checked="" type="checkbox"/>	Supply fan stop, exhaust fan normal operation (factory setting)
	9	<input type="checkbox"/>	Supply fan stop, exhaust fan stop

Trial operation

After the system has been installed and before the ceiling panel is installed, make sure that wires are properly connected, then test the system's operation, referring to the operation manual for the remote controller.

1. Trial operation using the remote controllers (PZ-60DR-E, PZ-41SLB-E and PZ-52SF-E)

Follow the procedure shown in the operation manual for the remote controller the functions below.

- Start operation.
- Fan speed selection.
- Function selection.
- Stop operation.

Trial operation (continued)

2. Stand-alone Lossnay trial operation

- (1) Supply power to the Lossnay unit.
- (2) Turn the trial operation switch (SW2-1) "On."
 - Operation will start with the "High" setting and with Bypass ventilation operating. (This will take approximately 1 minute after the power is turned on.)
- (3) Confirm that the Bypass damper plate in the Lossnay unit is operated.
- (4) Turn the trial operation switch (SW2-1) "Off."

SW2	OFF	ON	Operation
	1		

3. Complete system trial operation

- **Interlock system containing an indoor unit and/or external device**
 - Use the remote controller for the indoor unit or the operating switches for the external device and confirm that the indoor unit and Lossnay are interlocked.
 - If delay time has been set, check that the Lossnay operates after the delay time has passed.
- **If MELANS System**
 - Use MELANS to confirm the operation of the Lossnay.

4. If trouble occurs during trial operation

Symptom	Remedy															
Will not operate even when the operation switch for the remote controller (PZ-60DR-E, PZ-41SLB-E) and/or operation switch for the Lossnay remote controller (PZ-52SF-E) is pressed.	<ul style="list-style-type: none"> • Check the power supply. (The specified power supply is single-phase 220-240V ~ 50Hz.) • Check for a short circuit or disconnection in the transmission cable. (Check that the voltage between terminals in the transmission cables is 9 to 15 VDC for the PZ-60DR-E or PZ-41SLB-E and 20 to 30 VDC for the PZ-52SF-E.) • Check that there is 5 cm or more separating the transmission cable from the power supply cable and any other transmission cables. • Run the Lossnay independently using the trial operation switch (SW2-1) and check if it runs. <table border="1" style="margin-left: 20px;"> <tr> <td>Lossnay runs</td> <td>→</td> <td>Check the signal lines</td> </tr> <tr> <td>Lossnay doesn't run</td> <td>→</td> <td>Check the power supply</td> </tr> </table> • Check if there are three or more remote controller connected (PZ-60DR-E or PZ-41SLB-E). (The maximum is two.) 	Lossnay runs	→	Check the signal lines	Lossnay doesn't run	→	Check the power supply									
Lossnay runs	→	Check the signal lines														
Lossnay doesn't run	→	Check the power supply														
"HO" flashes in remote controller for Lossnay (PZ-52SF-E).	<ul style="list-style-type: none"> • Perform the registration operation using the remote controller for the Lossnay (PZ-52SF-E) or MELANS. (Refer to the installation instructions for the remote controller for the Lossnay or MELANS.) 															
When using M-NET, the operation switch of Remote Controller (PZ-60DR-E), Lossnay remote controller (PZ-52SF-E) or MELANS is dead.	<ul style="list-style-type: none"> • Check the power supply. (Specified power supply: single-phase 220-240V, wire dia. ϕ1.6, switch capacity) • Check if the power supply unit is connected or not, and if the power is supplied or not (For a system with Lossnay only, it is necessary to install the power supply unit.) • Check the transmission wire for short-circuit or broken wire (Check if DC 20 - 30 V is detected between the terminals of transmission wire). • Check if a clearance of 5 cm is secured between the transmission wire and the power cable and other transmission wires. • Run Lossnay independently to see if it operates properly or not. <table border="1" style="margin-left: 20px;"> <tr> <td>Lossnay operates</td> <td>→</td> <td>Inspect the transmission wire</td> </tr> <tr> <td>Lossnay doesn't operate</td> <td>→</td> <td>Check the power supply</td> </tr> </table> 	Lossnay operates	→	Inspect the transmission wire	Lossnay doesn't operate	→	Check the power supply									
Lossnay operates	→	Inspect the transmission wire														
Lossnay doesn't operate	→	Check the power supply														
Does not operate even when the operation switch for remote controller for Lossnay (PZ-52SF-E) or MELANS is pressed.	<ul style="list-style-type: none"> • Check whether or not there is a power supply unit and that the power has been turned on. (On systems with only a Lossnay, a power supply unit is required.) 															
Indoor unit or external device does not interlock.	<ul style="list-style-type: none"> • Check if the pulse input switch (SW2-2) is off. (Can be set from PZ-60DR-E) • Check the overall cable length between the indoor unit or external device and Lossnay. (Refer to technical publications or other such documents.) • Check the connections at the external control input terminal block (TM2). <p style="margin-left: 20px;">In the case of voltage charged 12 or 24 VDC output device: Connect to external control input terminals ① and ②.</p> <p style="margin-left: 20px;">In the case of uncharged a-contact output device: Connect to external control input terminals ① and ③.</p> <p style="margin-left: 20px;">In the case of Mr. Slim (A control or K control): Connect to external control input terminals ① and ②.</p> • Perform the registration operation using the remote control for the air conditioner or MELANS. (Refer to the installation instructions for the remote controller for the indoor unit or MELANS.) • Check if the delay has been set. • Check the overall length of the transmission cable between the external device and Lossnay. (Refer to technical publications or other such documents.) • Check if the transmission cable from the external device has come off of the external control input terminal. <table border="1" style="margin-left: 20px;"> <thead> <tr> <th></th> <th>Operation signal</th> <th>Stop signal</th> </tr> </thead> <tbody> <tr> <td>Charged 12 or 24 VDC output device</td> <td>12 or 24 VDC</td> <td>0 VDC</td> </tr> <tr> <td>Uncharged a-contact output device</td> <td>Resistance: 0 Ω</td> <td>Unlimited resistance Ω</td> </tr> <tr> <td>Mr. Slim</td> <td>2 to 6 VDC (pulse signal)</td> <td>2 to 6 VDC (pulse signal)</td> </tr> </tbody> </table> • Check, in the case of multiple units, whether the Main/Sub selection switch on the Lossnay unit which is connected to the external control input terminal is set on the Master setting, and check whether the Main/Sub selection switch on other Lossnay units are set to Sub. 		Operation signal	Stop signal	Charged 12 or 24 VDC output device	12 or 24 VDC	0 VDC	Uncharged a-contact output device	Resistance: 0 Ω	Unlimited resistance Ω	Mr. Slim	2 to 6 VDC (pulse signal)	2 to 6 VDC (pulse signal)			
	Operation signal	Stop signal														
Charged 12 or 24 VDC output device	12 or 24 VDC	0 VDC														
Uncharged a-contact output device	Resistance: 0 Ω	Unlimited resistance Ω														
Mr. Slim	2 to 6 VDC (pulse signal)	2 to 6 VDC (pulse signal)														
Lossnay does not stop.	<ul style="list-style-type: none"> • Check that the trial operation switch (SW2-1) is set to off. 															
The inspection indicator lamp (LED 1 Green) in the control box flashes.	<table border="1" style="width: 100%;"> <tbody> <tr> <td>2 flashes</td> <td>Fault on Lossnay circuit</td> <td rowspan="4">Turn the power off and consult your dealer.</td> </tr> <tr> <td>3 flashes</td> <td>Fault on Damper devices</td> </tr> <tr> <td>4 flashes</td> <td>Fault on Lossnay thermostat (OA side)</td> </tr> <tr> <td>5 flashes</td> <td>Fault on Lossnay thermostat (RA side)</td> </tr> <tr> <td>8 flashes</td> <td>Improper OA temperature (outside the range)</td> <td></td> </tr> <tr> <td>On</td> <td>Operating</td> <td>Unless the Remote Controller (PZ-60DR-E) or remote controller switch (PZ-41SLB-E, etc) is used, the lamp extinguishes (operation stops) 30 minutes later.</td> </tr> </tbody> </table>	2 flashes	Fault on Lossnay circuit	Turn the power off and consult your dealer.	3 flashes	Fault on Damper devices	4 flashes	Fault on Lossnay thermostat (OA side)	5 flashes	Fault on Lossnay thermostat (RA side)	8 flashes	Improper OA temperature (outside the range)		On	Operating	Unless the Remote Controller (PZ-60DR-E) or remote controller switch (PZ-41SLB-E, etc) is used, the lamp extinguishes (operation stops) 30 minutes later.
2 flashes	Fault on Lossnay circuit	Turn the power off and consult your dealer.														
3 flashes	Fault on Damper devices															
4 flashes	Fault on Lossnay thermostat (OA side)															
5 flashes	Fault on Lossnay thermostat (RA side)															
8 flashes	Improper OA temperature (outside the range)															
On	Operating	Unless the Remote Controller (PZ-60DR-E) or remote controller switch (PZ-41SLB-E, etc) is used, the lamp extinguishes (operation stops) 30 minutes later.														
The inspection indicator lamp (LED 2 Red) in the control box flashes.	<table border="1" style="width: 100%;"> <tbody> <tr> <td>1 to 8 flashes</td> <td>Error in M-NET communication</td> <td>Turn off the power and immediately contact your dealer.</td> </tr> <tr> <td>On</td> <td>Registration operation has not been performed.</td> <td>Use the controller to perform the registration.</td> </tr> </tbody> </table>	1 to 8 flashes	Error in M-NET communication	Turn off the power and immediately contact your dealer.	On	Registration operation has not been performed.	Use the controller to perform the registration.									
1 to 8 flashes	Error in M-NET communication	Turn off the power and immediately contact your dealer.														
On	Registration operation has not been performed.	Use the controller to perform the registration.														

- When an inspection number blinks on the remote controller, follow the procedures shown in the installation and operating manuals provided with the remote controller.
- If the remote controller is not used, operate after approximately 45 seconds of turning on the power for the Lossnay.