

Revision A:

- MFZ-KA25VA-**E2**, MFZ-KA35VA-**E2** and MFZ-KA50VA-**E2** have been added.
- "Failure mode recall function" has been corrected.
- RoHS PARTS LIST has been added.

Please void OB409.

INDOOR UNIT SERVICE MANUAL

No. OB409
REVISED EDITION-A

Wireless type Models

MFZ-KA25VA	- E1
MFZ-KA25VA	- E2
MFZ-KA35VA	- E1
MFZ-KA35VA	- E2
MFZ-KA50VA	- E1
MFZ-KA50VA	- E2

Outdoor unit service manual
SUZ-KA•VA(H) Series (OC322)
MXZ-A•VA Series (OB377, OC316)

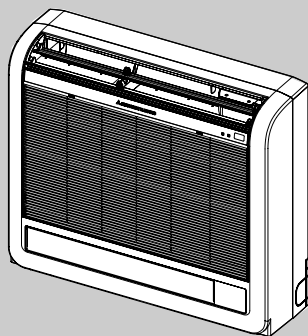

MFZ-KA25VA
MFZ-KA35VA
MFZ-KA50VA



CONTENTS

1. TECHNICAL CHANGES	2
2. PART NAMES AND FUNCTIONS.....	2
3. SPECIFICATION.....	4
4. NOISE CRITERIA CURVES	6
5. OUTLINES AND DIMENSIONS	7
6. WIRING DIAGRAM	8
7. REFRIGERANT SYSTEM DIAGRAM	8
8. PERFORMANCE CURVES	9
9. SERVICE FUNCTIONS	19
10. TROUBLESHOOTING.....	21
11. DISASSEMBLY INSTRUCTIONS.....	35
12. PARTS LIST.....	39
13. RoHS PARTS LIST.....	43
14. OPTIONAL PARTS.....	47

NOTE:

- This service manual describes technical data of the indoor units.
 - RoHS compliant products have <G> mark on the spec name plate.
- For servicing of RoHS compliant products, refer to the RoHS Parts List.



Revision A:

- MFZ-KA25VA-**E1**, MFZ-KA35VA-**E2** and MFZ-KA50VA-**E2** have been added.
- “Failure mode recall function” has been corrected.
- RoHS PARTS LIST has been added.

1 TECHNICAL CHANGES

MFZ-KA25VA-**E1** → MFZ-KA25VA-**E2**

MFZ-KA35VA-**E1** → MFZ-KA35VA-**E2**

MFZ-KA50VA-**E1** → MFZ-KA50VA-**E2**

1. The operation of thermo-off-unit has been changed. (When 2 or more indoor units are connected with a multi type outdoor unit, and operated in heat mode.)

<**E1**> Indoor fan operates with very Low speed or stops.

<**E2**> Indoor fan operates intermittently with very Low speed or stops.

2 PART NAMES AND FUNCTIONS

INDOOR UNIT

MFZ-KA25VA

MFZ-KA35VA

MFZ-KA50VA

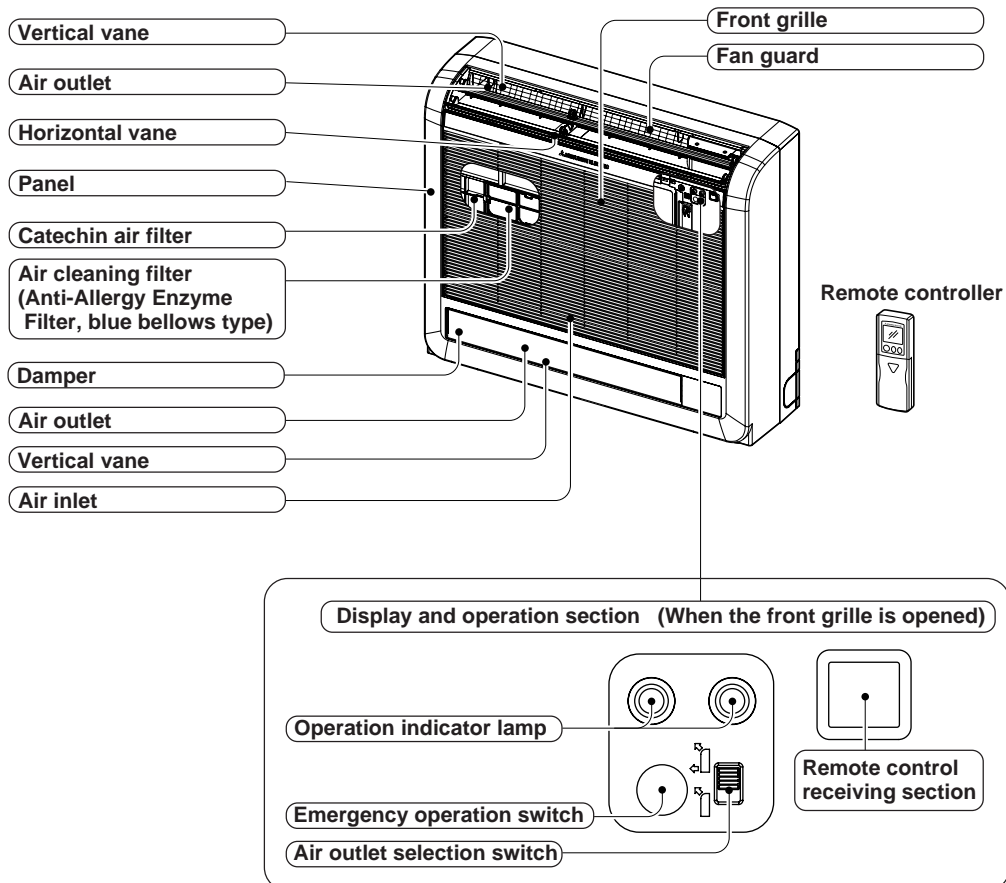



ACCESSORIES

		MFZ-KA25VA MFZ-KA35VA MFZ-KA50VA
①	Drain hose	1
②	Remote controller holder	1
③	Fixing screw for ② 3.5 × 1.6 mm (Black)	2
④	Pipe cover	1
⑤	Band	2
⑥	Battery (AAA) for remote controller	2
⑦	Indoor unit mounting bracket	1
⑧	Fixing screw for ⑦ 4 × 25 mm	5
⑨	Wood screw for the indoor unit fixation	4
⑩	Washer of ⑨	4
⑪	Felt tape (Used for left or left-rear piping)	1
⑫	Wireless remote controller	1
⑬	Air cleaning filter	1

**MFZ-KA25VA
MFZ-KA35VA
MFZ-KA50VA**

REMOTE CONTROLLER

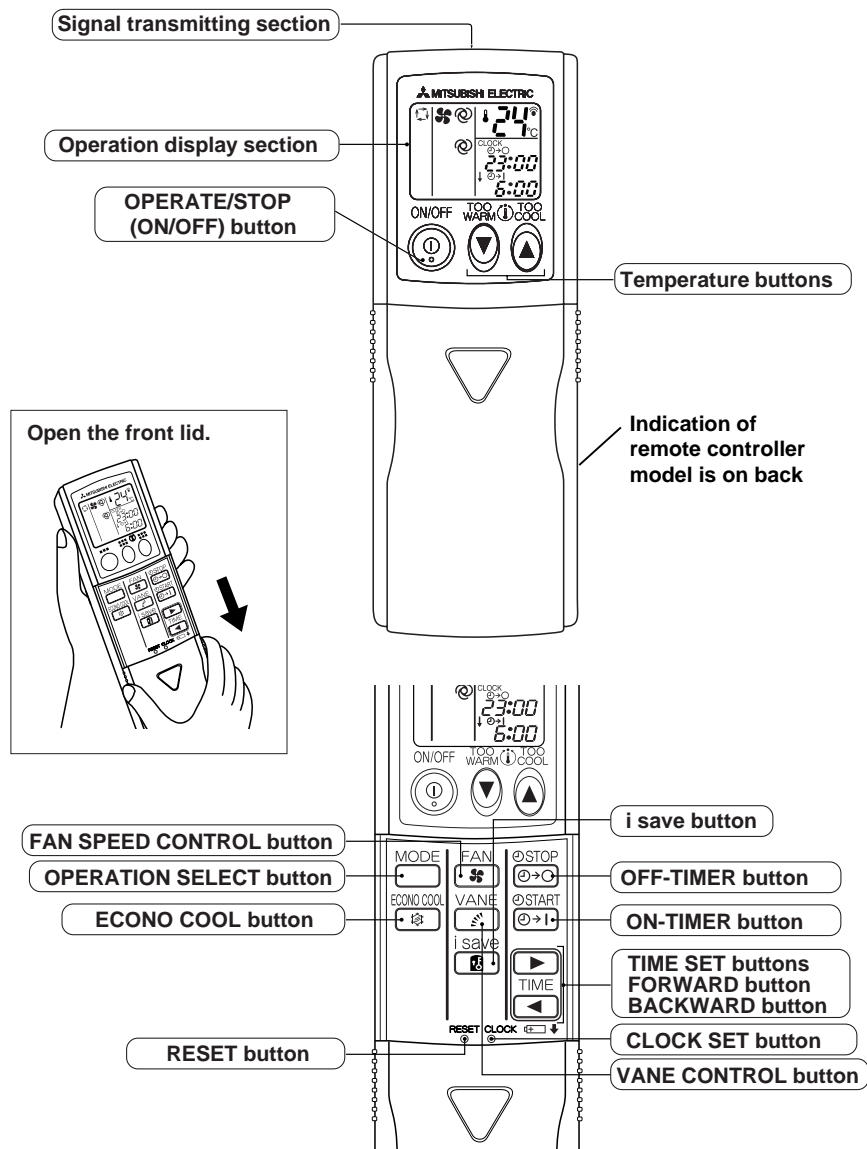

3

SPECIFICATION

Indoor model			MFZ-KA25VA		MFZ-KA35VA		MFZ-KA50VA		
Function			Cooling	Heating	Cooling	Heating	Cooling	Heating	
Power supply			Single phase 230V,50Hz		Single phase 230V,50Hz		Single phase 230V,50Hz		
Capacity	Air flow(Super High)	m ³ /h	522	546	546	570	642	708	
	Air flow(High/Med./Low)	m ³ /h	426/ 348/ 288	456/ 372/ 300	444/ 366/ 300	468/ 372/ 312	552/ 474/ 426	588/ 528/ 444	
Electrical data	Power outlet	A	10		10		10		
	Running current *1	A	0.2		0.2		0.2		
	Power input *1	W	25		25		25		
	Auxiliary heater	A(kW)	—		—		—		
	Power factor *1	%	54		54		54		
	Fan motor current *1	A	0.2		0.2		0.2		
Fan motor	Model (Upper)		RC0J30-GA		RC0J30-GA		RC0J30-GA		
	Model (Lower)		RC0J30-HA		RC0J30-HA		RC0J30-HA		
	Dimensions W×H×D	mm	700×600×200		700×600×200		700×600×200		
	Weight	kg	14		14		14		
Special remarks	Air direction		5		5		5		
	Sound level(Super High)	dB(A)	37		38		43	44	
	Sound level(High/Med./Low)	dB(A)	32/ 27/ 22		33/ 28/ 23	38/ 28/ 25	39/ 35/ 32		
	Upper	Fan speed(Super High)	rpm	1,080	1,010	1,130	1,030	1,280	1,260
		Fan speed(High/Med./Low)	rpm	940/ 800/ 700	870/ 740/ 630	970/ 830/ 720	890/ 740/ 650	1,140/ 1,020/ 940	1,070/ 930/ 850
	Lower	Fan speed(Super High)	rpm	880	1,010	930	1,030	1,080	1,260
		Fan speed(High/Med./Low)	rpm	740/ 650/ 550	870/ 740/ 630	770/ 680/ 570	890/ 740/ 650	940/ 820/ 740	1,070/ 930/ 850
	Fan speed regulator		4		4		4		
	Thermistor RT11(at 25°C)	kΩ	10		10		10		
	Thermistor RT12(at 25°C)	kΩ	10		10		10		
	Thermistor RT13(at 25°C)	kΩ	10		10		10		
Thermistor RT14(at 25°C)	kΩ	10		10		10			
Thermistor RT15(at 25°C)	kΩ	10		10		10			
	Remote controller model		KM05G		KM05G		KM05G		

NOTE : Test conditions are based on ISO 5151.

Cooling : Indoor Dry-bulb temperature 27°C Wet-bulb temperature 19°C

Outdoor Dry-bulb temperature 35°C Wet-bulb temperature 24°C

Heating : Indoor Dry-bulb temperature 20°C Wet-bulb temperature 15°C

Outdoor Dry-bulb temperature 7°C Wet-bulb temperature 6°C

Refrigerant piping length (one way): 5m

*1 Measured under rated operating frequency.

Outdoor model		SUZ-KA25VA(H).TH Indoor model MFZ-KA25VA		SUZ-KA35VA(H).TH Indoor model MFZ-KA35VA		SUZ-KA50VA.TH Indoor model MFZ-KA50VA		
Function		Cooling	Heating	Cooling	Heating	Cooling	Heating	
Power supply		Single phase 230V,50Hz		Single phase 230V,50Hz		Single phase 230V,50Hz		
Capacity	Capacity Rated frequency(Min.-Max.)	kW	2.5 (0.9 - 3.4)	3.4 (0.9 - 5.1)	3.5 (0.9 - 3.9)	4.0 (0.9 - 6.2)	4.8 (0.9 - 5.4)	6.0(0.9 - 7.9)
	Dehumidification	ℓ /h	1.2		1.7		2.5	
	Air flow(High/Low)	m³ /h	1,890/ 1,746	2,058 / 1,506	1,896 / 1,668	1,956 / 1,356	2,940 / 1,650	2,940 / 2,210
Electrical data	Starting current *1	A	4.0		5.0		8.5	
	Compressor motor current *1	A	2.3	3.5	4.5	4.5	6.5	8.0
	Fan motor current *1	A	0.33		0.33		0.30	
Coefficient of performance (C.O.P) *1			4.31	4.07	3.21	3.64	3.10	3.23
Compressor	Model		KNB073FDVH		KNB092FCAH		SNB130FLDH	
	Output	W	550		650		850	
	Winding resistance(at 20°C)	Ω	U-V 1.53	U-W 1.53	U-V 0.49	U-W 0.49	U-V 0.45	U-W 0.45
Fan motor	Model		RC0J50-AL		RC0J50-AL		RC0J60-AA	
	Winding resistance(at 20°C)	Ω	WHT-BLK 37.5		WHT-BLK 37.5		WHT-BLK 15.2	
			BLK-RED 37.5		BLK-RED 37.5		BLK-RED 15.2	
			RED-WHT 37.5		RED-WHT 37.5		RED-WHT 15.2	
Dimensions W×H×D		mm	800×550×285		800×550×285		840×850×330	
Weight		kg	33		37		53	
Special remarks	Sound level *1	dB	46		47	48	53	55
	Fan speed(High/Low, High/Med/Low)	rpm	810/ 750	880/810/650	840/ 760	880/ 800/ 630	800/ 480	800/ 650
	Fan speed regulator		2	3	2	3	2	
	Refrigerant filling capacity(R410A)	kg	0.90		1.05		1.60	
	Refrigerating oil (Model)	cc	320 (NEO22)		320 (NEO22)		450 (NEO22)	
	Thermistor RT61 (at 0°C)	kΩ	32.6		32.6		—	
	Thermistor RT62 (at 100°C)	kΩ	13.4		13.4		—	
	Thermistor RT64 (at 50°C)	kΩ	17		17		—	
	Thermistor RT65 (at 25°C)	kΩ	10		10		—	
	Thermistor RT61 (at 25°C)	kΩ	—		—		10.0	
	Thermistor RT62 (at 100°C)	kΩ	—		—		13.4	
	Thermistor RT64 (at 50°C)	kΩ	—		—		17.0	
	Thermistor RT65 (at 25°C)	kΩ	—		—		10.0	
Thermistor RT68 (at 25°C)	kΩ	—		—		10.0		

NOTE : Test conditions are based on ISO 5151.

Cooling : Indoor Dry-bulb temperature 27°C Wet-bulb temperature 19°C

Outdoor Dry-bulb temperature 35°C Wet-bulb temperature 24°C

Heating : Indoor Dry-bulb temperature 20°C Wet-bulb temperature 15°C

Outdoor Dry-bulb temperature 7°C Wet-bulb temperature 6°C

Refrigerant piping length (one way): 5m

*1 Measured under rated operating frequency.

Specifications and rating conditions of main electric parts

Item	Model	MFZ-KA25VA	MFZ-KA35VA	MFZ-KA50VA
Fuse	(F11)	T3.15AL 250V		
Damper lock motor Right	(ML1)	12V 300Ω		
Damper lock motor Left	(ML2)	12V 300Ω		
Horizontal vane motor	(MV1)	12V 300Ω		
Damper motor	(MV2)	12V 300Ω		
Varistor	(NR11)	ERZV14D471		

MFZ-KA25VA

FAN SPEED	FUNCTION	SPL(dB(A))	LINE
Super High	COOLING	37	●—●
	HEATING	37	○—○

Test conditions,

Cooling : Dry-bulb temperature 27°C Wet-bulb temperature 19°C
 Heating : Dry-bulb temperature 20°C Wet-bulb temperature 15°C

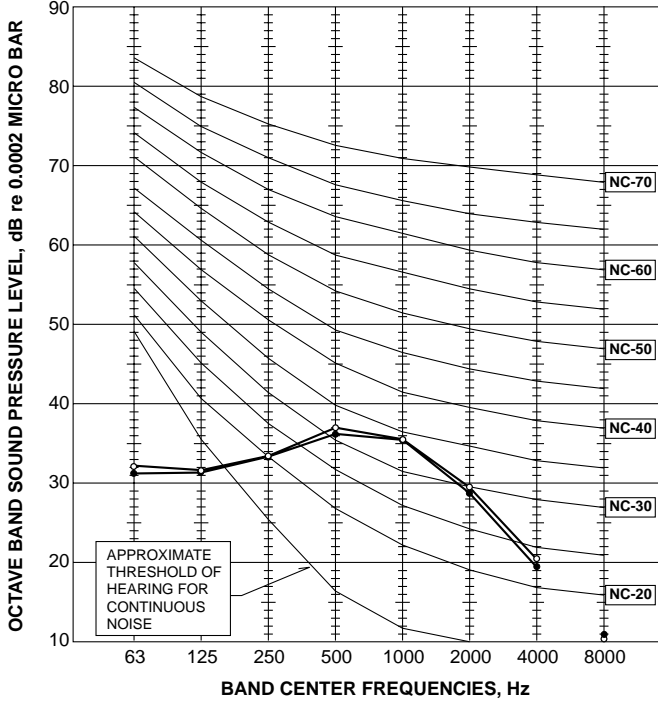

MFZ-KA35VA

FAN SPEED	FUNCTION	SPL(dB(A))	LINE
Super High	COOLING	38	●—●
	HEATING	38	○—○

Test conditions,

Cooling : Dry-bulb temperature 27°C Wet-bulb temperature 19°C
 Heating : Dry-bulb temperature 20°C Wet-bulb temperature 15°C

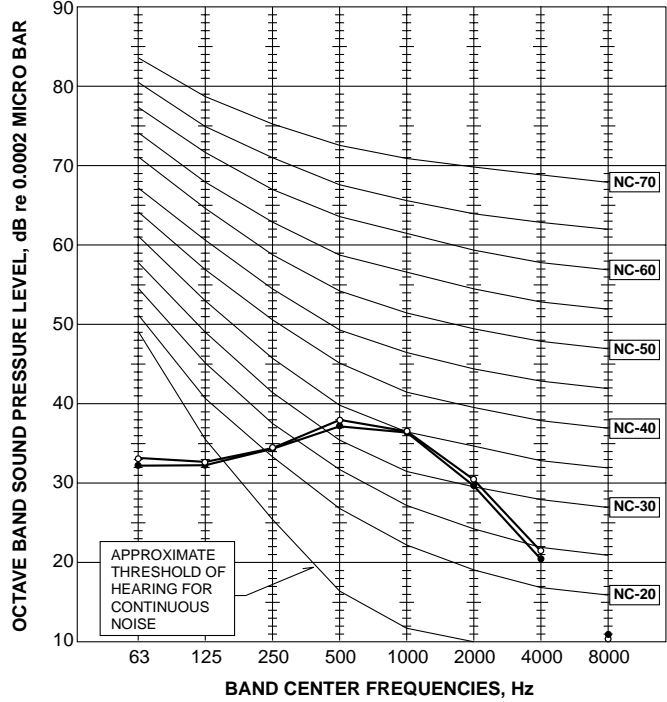

MFZ-KA50VA

FAN SPEED	FUNCTION	SPL(dB(A))	LINE
Super High	COOLING	43	●—●
	HEATING	44	○—○

Test conditions,

Cooling : Dry-bulb temperature 27°C Wet-bulb temperature 19°C
 Heating : Dry-bulb temperature 20°C Wet-bulb temperature 15°C

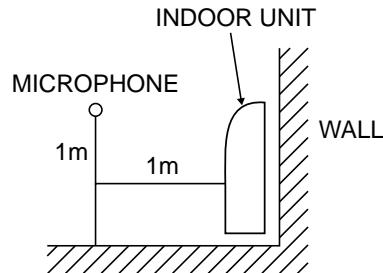
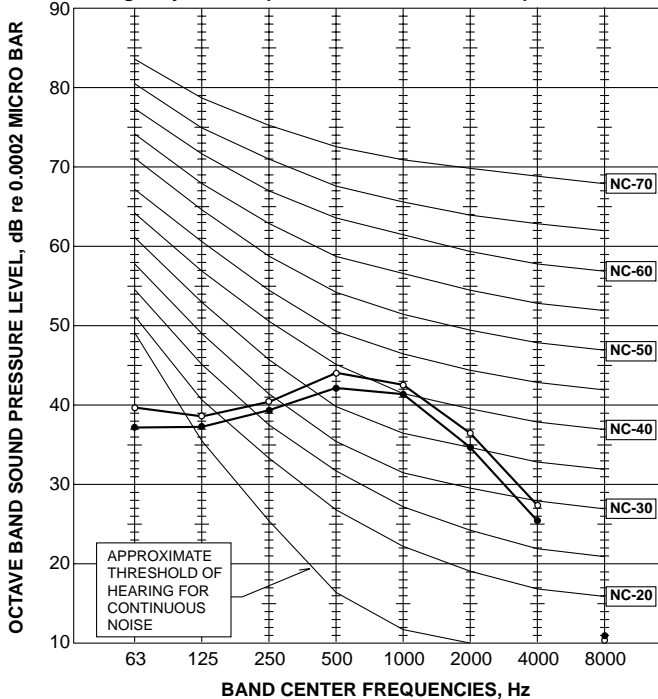

5

OUTLINES AND DIMENSIONS

MFZ-KA25VA
MFZ-KA35VA
MFZ-KA50VA

Unit : mm

INDOOR UNIT

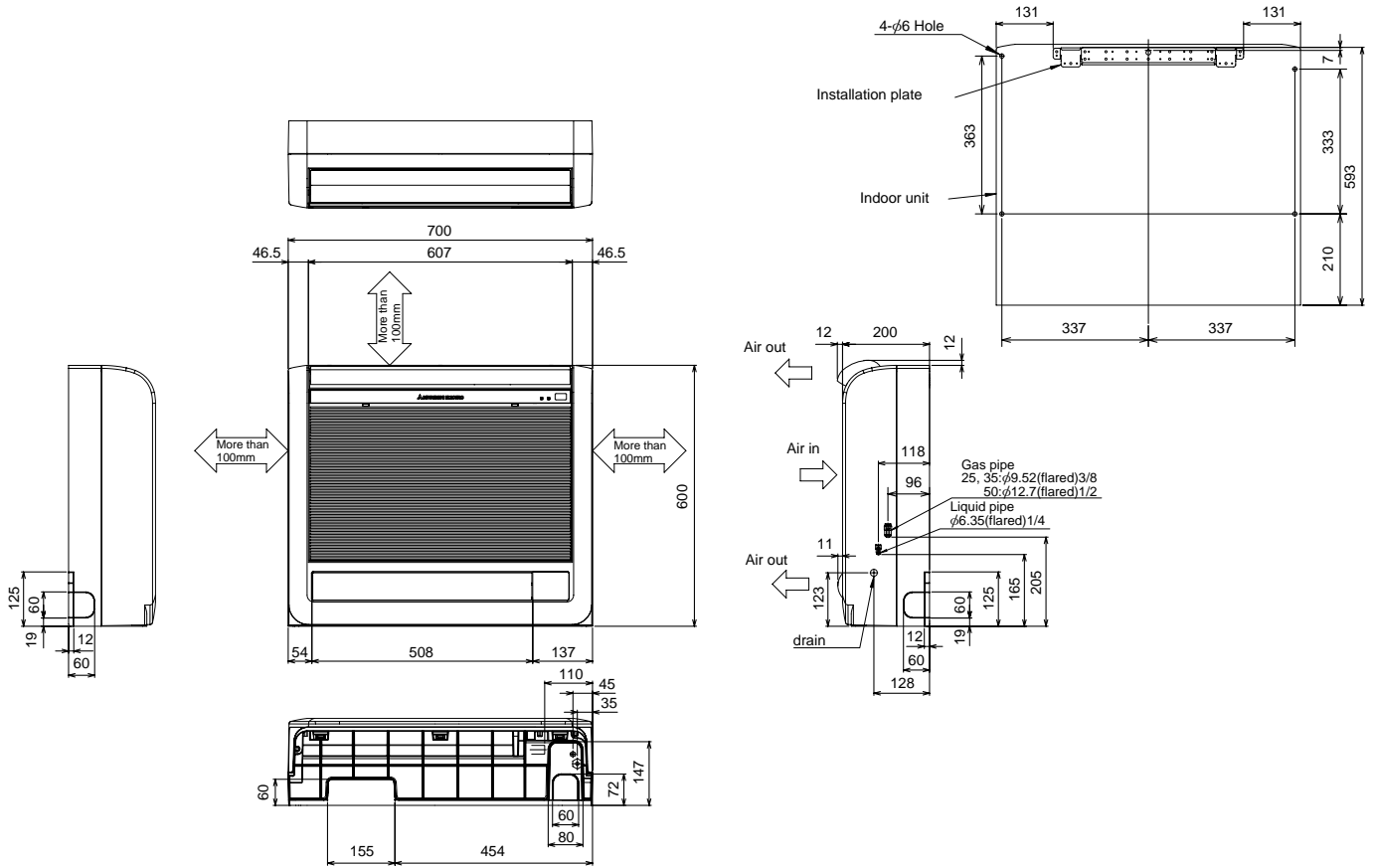

6

WIRING DIAGRAM

MFZ-KA25VA
MFZ-KA35VA
MFZ-KA50VA

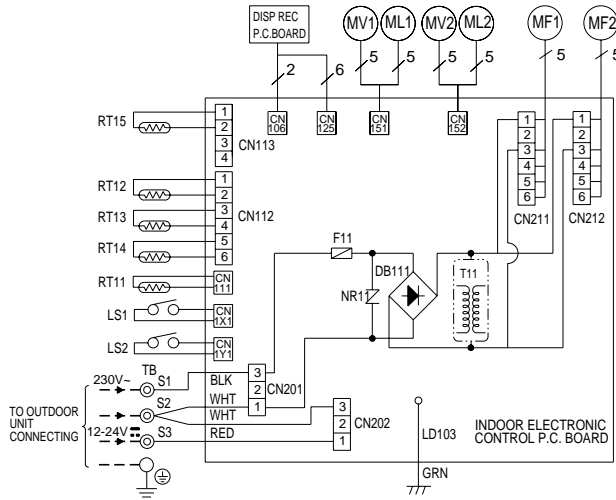

SYMBOL	NAME	SYMBOL	NAME	SYMBOL	NAME
DB111	DIODE STACK	ML2	DAMPER LOCK MOTOR (LEFT)	RT14	INDOOR COIL THERMISTOR (MAIN 2)
F11	FUSE (T3.15AL250V)	MV1	HORIZONTAL VANE MOTOR	TR15	INDOOR COIL THERMISTOR (MAIN 3)
LS1	DAMPER LIMIT SWITCH (OPEN)	MV2	DAMPER MOTOR	T11	TRANSFORMER
LS2	DAMPER LIMIT SWITCH (CLOSE)	NR11	VARISTOR		
MF1	UPPER INDOOR FAN MOTOR	RT11	ROOM TEMPERATURE THERMISTOR		
MF2	LOWER INDOOR FAN MOTOR	RT12	INDOOR COIL THERMISTOR (MAIN 1)		
ML1	DAMPER LOCK MOTOR (RIGHT)	RT13	INDOOR COIL THERMISTOR (SUB)		

NOTE: 1. About the outdoor side electric wiring refer to the outdoor unit electric wiring diagram for servicing.
2. Use copper conductors only. (For field wiring)
3. Symbols below indicate.
⊙: Terminal block, □□□□: Connector

7

REFRIGERANT SYSTEM DIAGRAM

MFZ-KA25VA
MFZ-KA35VA
MFZ-KA50VA

INDOOR UNIT

Unit : mm

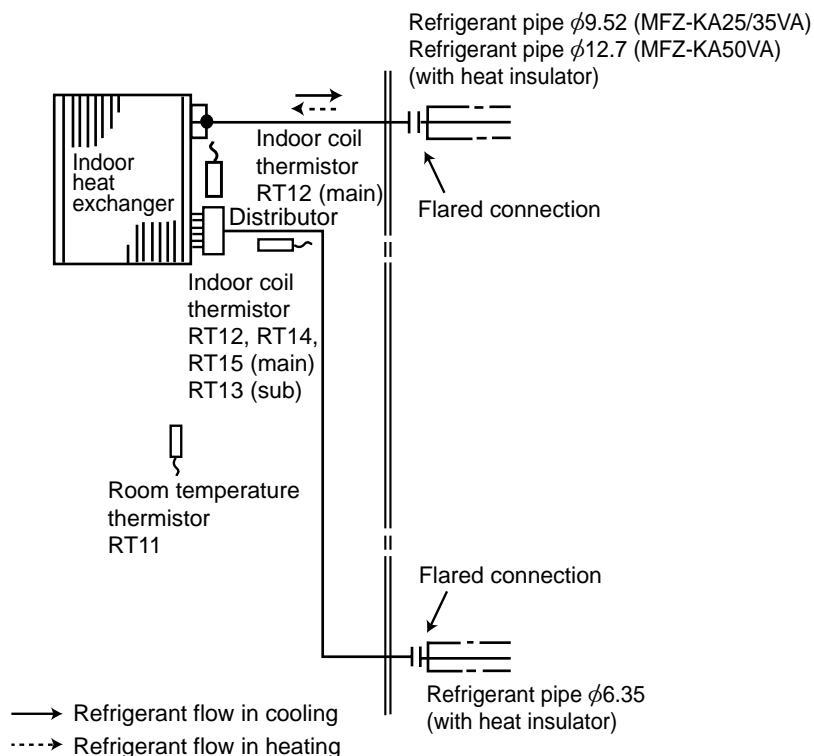

MFZ-KA25VA
MFZ-KA35VA
MFZ-KA50VA

The standard data contained in these specifications apply only to the operation of the air conditioner under normal condition. Operating conditions vary according to the areas where these units are installed. The following information has been provided to clarify the operating characteristics of the air conditioner under the conditions indicated by the performance curve.

(1) GUARANTEED VOLTAGE

(2) AIR FLOW

Air flow should be set at MAX.

(3) MAIN READINGS

COOLING

- (1) Indoor intake air wet-bulb temperature : W.B. °C
- (2) Indoor outlet air wet-bulb temperature : W.B. °C
- (3) Outdoor intake air dry-bulb temperature : D.B. °C
- (4) Total input : W

Indoor air wet/dry-bulb temperature difference on the side of the following chart shows the difference between the indoor intake air wet/dry-bulb temperature and the indoor outlet air wet/dry-bulb temperature for your reference at service.

HEATING

- (1) Indoor intake air dry-bulb temperature : D.B. °C
- (2) Indoor outlet air dry-bulb temperature : D.B. °C
- (3) Outdoor intake air wet-bulb temperature : W.B. °C
- (4) Total input : W

How to measure the indoor air wet-bulb/dry-bulb temperature difference

1. Attach at least 2 sets of wet-and-dry-bulb thermometers to the indoor air inlet as shown in the figure, and at least 2 sets of wet-and-dry-bulb thermometers to the indoor air outlet. The thermometers must be attached to the position where air speed is high.
2. Attach at least 2 sets of wet-and-dry-bulb thermometers to the outdoor air inlet.
Cover the thermometers to prevent direct rays of the sun.
3. Check that the air filter is cleaned.
4. Open windows and doors of the room.
5. Press the EMERGENCY OPERATION switch once to start the COOL(HEAT) MODE.
6. When system stabilizes after more than 15 minutes, measure temperature and take an average temperature.
7. 10 minutes later, measure temperature again and check that the temperature does not change.

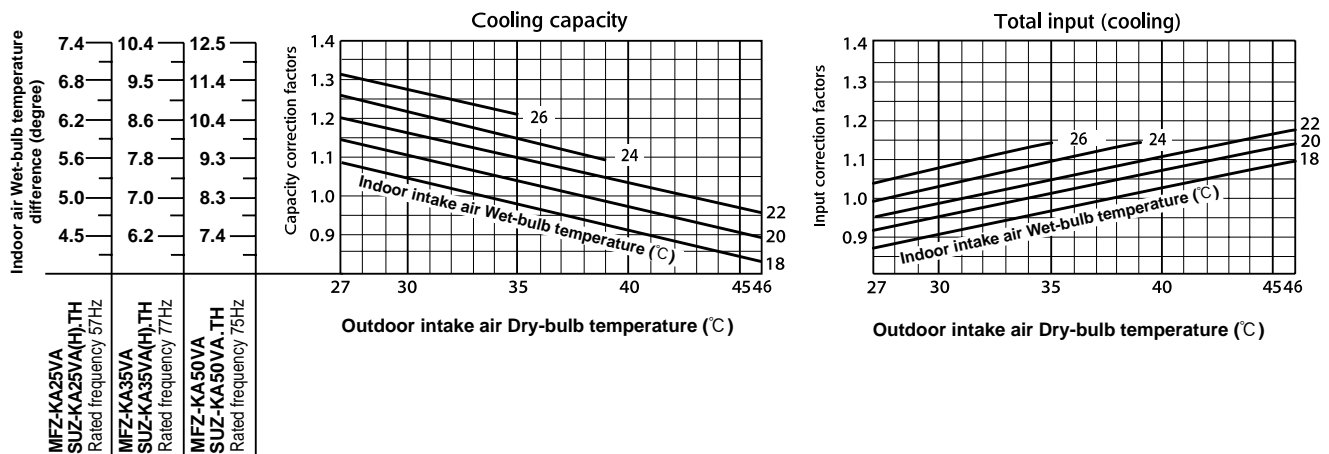
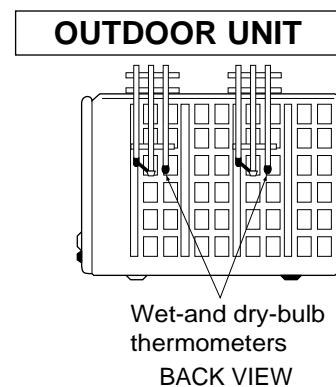
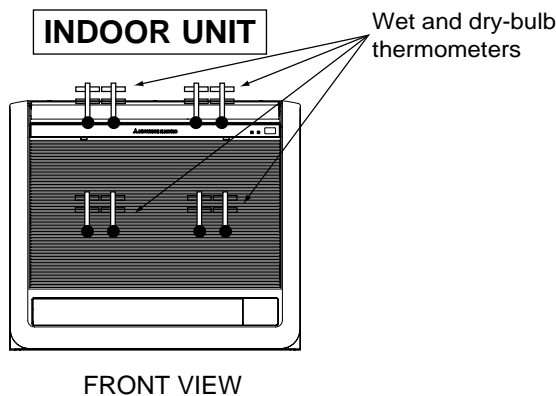

Indoor air Dry-bulb temperature difference (degree)	24.4	27.5	33.0
	22.6	25.4	30.4
	20.7	23.3	27.9
	18.8	21.2	25.4
	16.9	19.1	22.8
	15.0	16.9	20.3
	13.2	14.8	17.8
	11.3	12.7	15.2
MFZ-KA25VA SUZ-KA25VA(H).TH Rated frequency 80Hz			
MFZ-KA35VA SUZ-KA35VA(H).TH Rated frequency 74Hz			
MFZ-KA50VA SUZ-KA50VA.H.TH Rated frequency 79Hz			

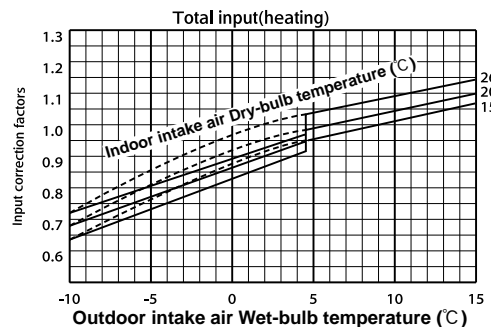
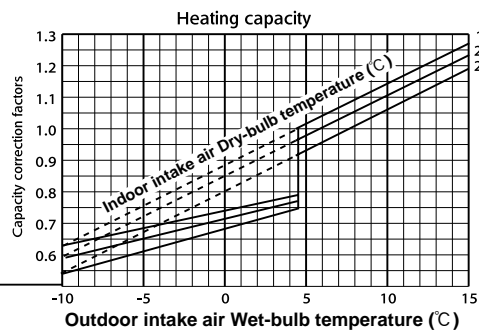

NOTE: The above curves are for the heating operation without any frost.

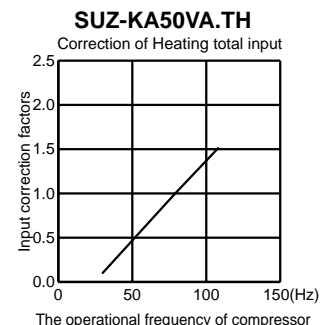
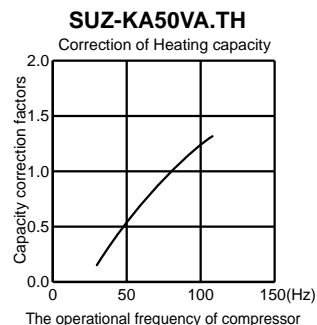
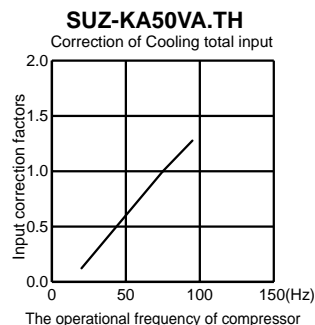
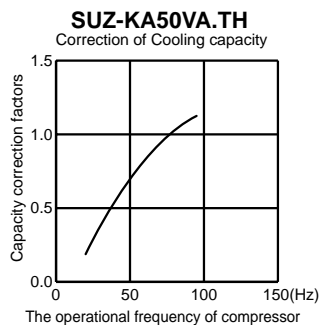
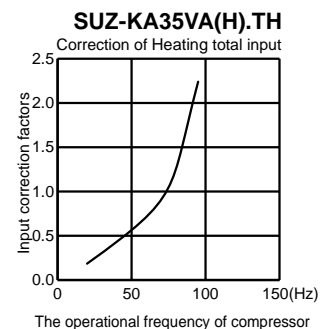
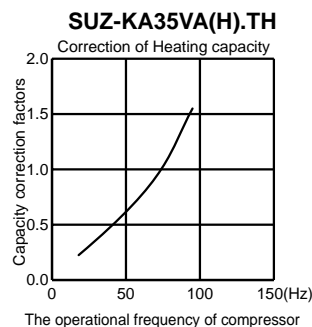
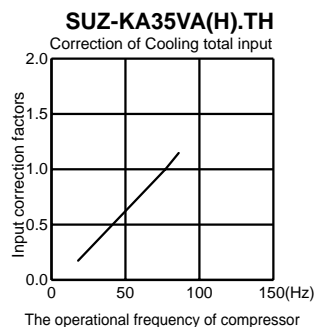
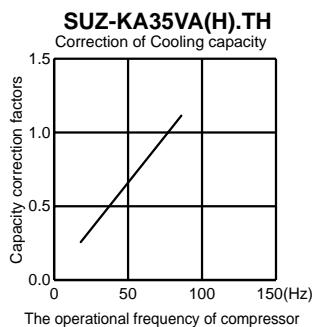
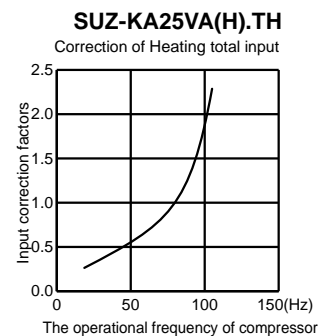
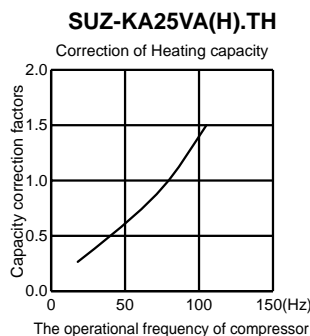
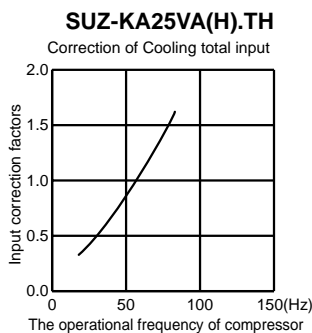
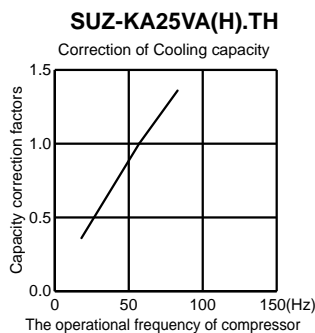

OUTDOOR LOW PRESSURE AND OUTDOOR UNIT CURRENT

<How to operate fixed-frequency operation (Test run operation)>

1. Press the EMERGENCY OPERATION switch or the Test button to COOL or HEAT mode.
2. Test run operation starts and continue to operate for 30 minutes.
3. Compressor starts at rated frequency in COOL mode or 58Hz in HEAT mode.
4. Indoor fan operates at High speed.
5. After 30 minutes, test run operation finishes and EMERGENCY OPERATION starts.
6. To cancel test run operation (EMERGENCY OPERATION), press the EMERGENCY OPERATION switch or the ON/OFF button on remote controller.

NOTE : The unit of pressure has been changed to MPa on the international system of units (SI unit system).

The conversion factor is: $1(\text{MPa [Gauge]}) = 10.2(\text{kgf/cm}^2 \text{ [Gauge]})$

OUTDOOR LOW PRESSURE AND OUTDOOR UNIT CURRENT COOLING operation

- ① Both indoor and outdoor unit are under the same temperature/humidity condition.
- ② Air flow : High speed
- ③ Operational frequency : 57Hz (SUZ-KA25VA(H).TH)
77Hz (SUZ-KA35VA(H).TH)
75Hz (SUZ-KA50VA.TH)

Dry-bulb temperature	Relative humidity(%)
20	50
25	60
30	70

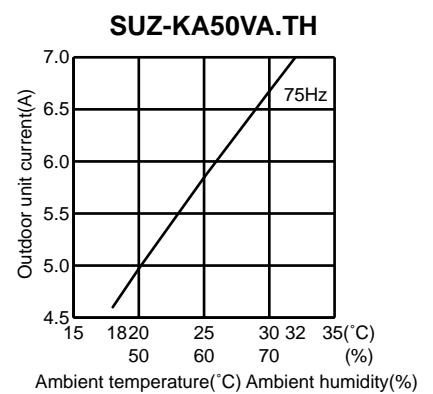
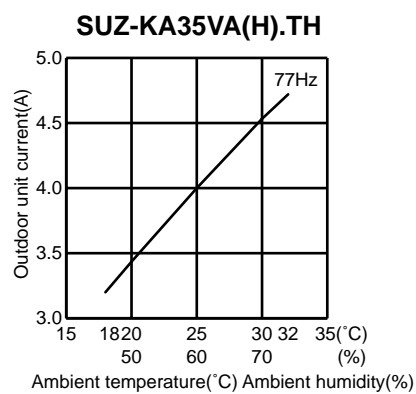
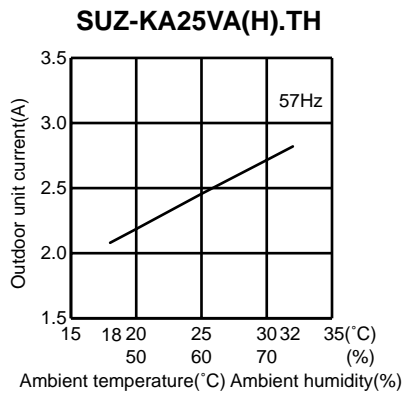
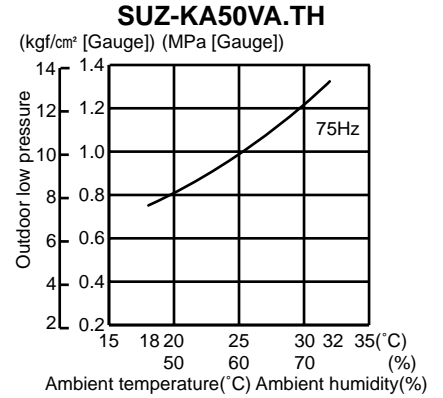
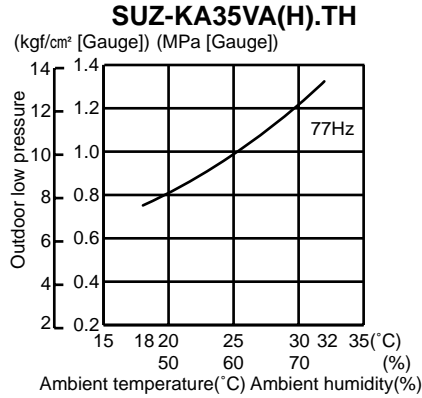
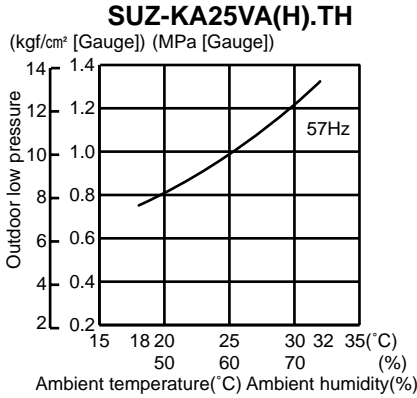

HEATING operation

- Condition indoor: Dry bulb temperature 20.0°C
Wet bulb temperature 14.5°C
- Condition outdoor: Dry bulb temperature 2,7,15,20.0°C
Wet bulb temperature 1,6,12,14.5°C

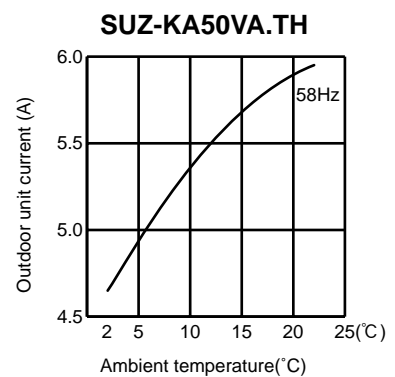
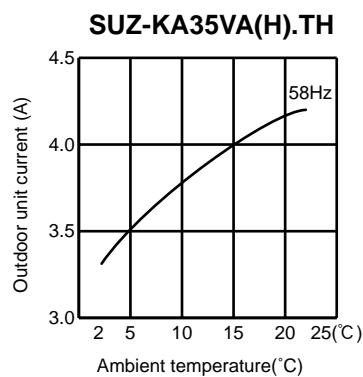
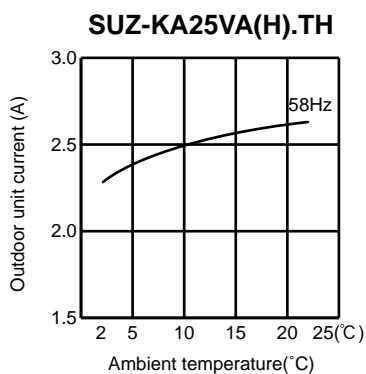

PERFORMANCE DATA

COOLING operation Rated frequency 57Hz

MFZ-KA25VA/ SUZ-KA25VA.TH, SUZ-KA25VAH.TH

CAPACITY : 2.5(kW) SHF : 0.66 INPUT : 580(W)

		OUTDOOR DB(°C)															
INDOOR DB(°C)	INDOOR WB(°C)	21				25				27				30			
		Q	SHC	SHF	INPUT	Q	SHC	SHF	INPUT	Q	SHC	SHF	INPUT	Q	SHC	SHF	INPUT
21	18	2.94	1.41	0.48	464	2.81	1.35	0.48	487	2.70	1.30	0.48	510	2.60	1.25	0.48	534
21	20	3.06	1.10	0.36	487	2.94	1.06	0.36	516	2.85	1.03	0.36	528	2.75	0.99	0.36	551
22	18	2.94	1.53	0.52	464	2.81	1.46	0.52	487	2.70	1.40	0.52	510	2.60	1.35	0.52	534
22	20	3.06	1.23	0.40	487	2.94	1.18	0.40	516	2.85	1.14	0.40	528	2.75	1.10	0.40	551
22	22	3.19	0.89	0.28	505	3.08	0.86	0.28	537	3.00	0.84	0.28	551	2.88	0.81	0.28	574
23	18	2.94	1.65	0.56	464	2.81	1.58	0.56	487	2.70	1.51	0.56	510	2.60	1.46	0.56	534
23	20	3.06	1.35	0.44	487	2.94	1.29	0.44	516	2.85	1.25	0.44	528	2.75	1.21	0.44	551
23	22	3.19	1.02	0.32	505	3.08	0.98	0.32	537	3.00	0.96	0.32	551	2.88	0.92	0.32	574
24	18	2.94	1.76	0.60	464	2.81	1.69	0.60	487	2.70	1.62	0.60	510	2.60	1.56	0.60	534
24	20	3.06	1.47	0.48	487	2.94	1.41	0.48	516	2.85	1.37	0.48	528	2.75	1.32	0.48	551
24	22	3.19	1.15	0.36	505	3.08	1.11	0.36	537	3.00	1.08	0.36	551	2.88	1.04	0.36	574
24	24	3.35	0.80	0.24	528	3.23	0.77	0.24	557	3.15	0.76	0.24	574	3.05	0.73	0.24	603
25	18	2.94	1.88	0.64	464	2.81	1.80	0.64	487	2.70	1.73	0.64	510	2.60	1.66	0.64	534
25	20	3.06	1.59	0.52	487	2.94	1.53	0.52	516	2.85	1.48	0.52	528	2.75	1.43	0.52	551
25	22	3.19	1.28	0.40	505	3.08	1.23	0.40	537	3.00	1.20	0.40	551	2.88	1.15	0.40	574
25	24	3.35	0.94	0.28	528	3.23	0.90	0.28	557	3.15	0.88	0.28	574	3.05	0.85	0.28	603
26	18	2.94	2.00	0.68	464	2.81	1.91	0.68	487	2.70	1.84	0.68	510	2.60	1.77	0.68	534
26	20	3.06	1.72	0.56	487	2.94	1.65	0.56	516	2.85	1.60	0.56	528	2.75	1.54	0.56	551
26	22	3.19	1.40	0.44	505	3.08	1.35	0.44	537	3.00	1.32	0.44	551	2.88	1.27	0.44	574
26	24	3.35	1.07	0.32	528	3.23	1.03	0.32	557	3.15	1.01	0.32	574	3.05	0.98	0.32	603
26	26	3.45	0.69	0.20	557	3.35	0.67	0.20	586	3.30	0.66	0.20	603	3.20	0.64	0.20	621
27	18	2.94	2.12	0.72	464	2.81	2.03	0.72	487	2.70	1.94	0.72	510	2.60	1.87	0.72	534
27	20	3.06	1.84	0.60	487	2.94	1.76	0.60	516	2.85	1.71	0.60	528	2.75	1.65	0.60	551
27	22	3.19	1.53	0.48	505	3.08	1.48	0.48	537	3.00	1.44	0.48	551	2.88	1.38	0.48	574
27	24	3.35	1.21	0.36	528	3.23	1.16	0.36	557	3.15	1.13	0.36	574	3.05	1.10	0.36	603
27	26	3.45	0.83	0.24	557	3.35	0.80	0.24	586	3.30	0.79	0.24	603	3.20	0.77	0.24	621
28	18	2.94	2.23	0.76	464	2.81	2.14	0.76	487	2.70	2.05	0.76	510	2.60	1.98	0.76	534
28	20	3.06	1.96	0.64	487	2.94	1.88	0.64	516	2.85	1.82	0.64	528	2.75	1.76	0.64	551
28	22	3.19	1.66	0.52	505	3.08	1.60	0.52	537	3.00	1.56	0.52	551	2.88	1.50	0.52	574
28	24	3.35	1.34	0.40	528	3.23	1.29	0.40	557	3.15	1.26	0.40	574	3.05	1.22	0.40	603
28	26	3.45	0.97	0.28	557	3.35	0.94	0.28	586	3.30	0.92	0.28	603	3.20	0.90	0.28	621
29	18	2.94	2.35	0.80	464	2.81	2.25	0.80	487	2.70	2.16	0.80	510	2.60	2.08	0.80	534
29	20	3.06	2.08	0.68	487	2.94	2.00	0.68	516	2.85	1.94	0.68	528	2.75	1.87	0.68	551
29	22	3.19	1.79	0.56	505	3.08	1.72	0.56	537	3.00	1.68	0.56	551	2.88	1.61	0.56	574
29	24	3.35	1.47	0.44	528	3.23	1.42	0.44	557	3.15	1.39	0.44	574	3.05	1.34	0.44	603
29	26	3.45	1.10	0.32	557	3.35	1.07	0.32	586	3.30	1.06	0.32	603	3.20	1.02	0.32	621
30	18	2.94	2.47	0.84	464	2.81	2.36	0.84	487	2.70	2.27	0.84	510	2.60	2.18	0.84	534
30	20	3.06	2.21	0.72	487	2.94	2.12	0.72	516	2.85	2.05	0.72	528	2.75	1.98	0.72	551
30	22	3.19	1.91	0.60	505	3.08	1.85	0.60	537	3.00	1.80	0.60	551	2.88	1.73	0.60	574
30	24	3.35	1.61	0.48	528	3.23	1.55	0.48	557	3.15	1.51	0.48	574	3.05	1.46	0.48	603
30	26	3.45	1.24	0.36	557	3.35	1.21	0.36	586	3.30	1.19	0.36	603	3.20	1.15	0.36	621
31	18	2.94	2.59	0.88	464	2.81	2.48	0.88	487	2.70	2.38	0.88	510	2.60	2.29	0.88	534
31	20	3.06	2.33	0.76	487	2.94	2.23	0.76	516	2.85	2.17	0.76	528	2.75	2.09	0.76	551
31	22	3.19	2.04	0.64	505	3.08	1.97	0.64	537	3.00	1.92	0.64	551	2.88	1.84	0.64	574
31	24	3.35	1.74	0.52	528	3.23	1.68	0.52	557	3.15	1.64	0.52	574	3.05	1.59	0.52	603
31	26	3.45	1.38	0.40	557	3.35	1.34	0.40	586	3.30	1.32	0.40	603	3.20	1.28	0.40	621
32	18	2.94	2.70	0.92	464	2.81	2.59	0.92	487	2.70	2.48	0.92	510	2.60	2.39	0.92	534
32	20	3.06	2.45	0.80	487	2.94	2.35	0.80	516	2.85	2.28	0.80	528	2.75	2.20	0.80	551
32	22	3.19	2.17	0.68	505	3.08	2.09	0.68	537	3.00	2.04	0.68	551	2.88	1.96	0.68	574
32	24	3.35	1.88	0.56	528	3.23	1.81	0.56	557	3.15	1.76	0.56	574	3.05	1.71	0.56	603
32	26	3.45	1.52	0.44	557	3.35	1.47	0.44	586	3.30	1.45	0.44	603	3.20	1.41	0.44	621

NOTE Q : Total capacity (kW) SHF : Sensible heat factor DB : Dry-bulb temperature
 SHC : Sensible heat capacity (kW) INPUT : Total power input (W) WB : Wet-bulb temperature

PERFORMANCE DATA

COOLING operation Rated frequency 57Hz

MFZ-KA25VA/ SUZ-KA25VA.TH, SUZ-KA25VAH.TH

CAPACITY : 2.5(kW) SHF : 0.66 INPUT : 580(W)

		OUTDOOR DB(°C)											
INDOOR DB (°C)	INDOOR WB (°C)	35				40				46			
		Q	SHC	SHF	INPUT	Q	SHC	SHF	INPUT	Q	SHC	SHF	INPUT
21	18	2.45	1.18	0.48	568	2.25	1.08	0.48	603	2.08	1.00	0.48	626
21	20	2.58	0.93	0.36	592	2.40	0.86	0.36	621	2.23	0.80	0.36	655
22	18	2.45	1.27	0.52	568	2.25	1.17	0.52	603	2.08	1.08	0.52	626
22	20	2.58	1.03	0.40	592	2.40	0.96	0.40	621	2.23	0.89	0.40	655
22	22	2.73	0.76	0.28	615	2.55	0.71	0.28	650	2.38	0.67	0.28	673
23	18	2.45	1.37	0.56	568	2.25	1.26	0.56	603	2.08	1.16	0.56	626
23	20	2.58	1.13	0.44	592	2.40	1.06	0.44	621	2.23	0.98	0.44	655
23	22	2.73	0.87	0.32	615	2.55	0.82	0.32	650	2.38	0.76	0.32	673
24	18	2.45	1.47	0.60	568	2.25	1.35	0.60	603	2.08	1.25	0.60	626
24	20	2.58	1.24	0.48	592	2.40	1.15	0.48	621	2.23	1.07	0.48	655
24	22	2.73	0.98	0.36	615	2.55	0.92	0.36	650	2.38	0.86	0.36	673
24	24	2.88	0.69	0.24	638	2.70	0.65	0.24	667	2.55	0.61	0.24	696
25	18	2.45	1.57	0.64	568	2.25	1.44	0.64	603	2.08	1.33	0.64	626
25	20	2.58	1.34	0.52	592	2.40	1.25	0.52	621	2.23	1.16	0.52	655
25	22	2.73	1.09	0.40	615	2.55	1.02	0.40	650	2.38	0.95	0.40	673
25	24	2.88	0.81	0.28	638	2.70	0.76	0.28	667	2.55	0.71	0.28	696
26	18	2.45	1.67	0.68	568	2.25	1.53	0.68	603	2.08	1.41	0.68	626
26	20	2.58	1.44	0.56	592	2.40	1.34	0.56	621	2.23	1.25	0.56	655
26	22	2.73	1.20	0.44	615	2.55	1.12	0.44	650	2.38	1.05	0.44	673
26	24	2.88	0.92	0.32	638	2.70	0.86	0.32	667	2.55	0.82	0.32	696
26	26	3.03	0.61	0.20	661	2.85	0.57	0.20	690	2.68	0.54	0.20	719
27	18	2.45	1.76	0.72	568	2.25	1.62	0.72	603	2.08	1.49	0.72	626
27	20	2.58	1.55	0.60	592	2.40	1.44	0.60	621	2.23	1.34	0.60	655
27	22	2.73	1.31	0.48	615	2.55	1.22	0.48	650	2.38	1.14	0.48	673
27	24	2.88	1.04	0.36	638	2.70	0.97	0.36	667	2.55	0.92	0.36	696
27	26	3.03	0.73	0.24	661	2.85	0.68	0.24	690	2.68	0.64	0.24	719
28	18	2.45	1.86	0.76	568	2.25	1.71	0.76	603	2.08	1.58	0.76	626
28	20	2.58	1.65	0.64	592	2.40	1.54	0.64	621	2.23	1.42	0.64	655
28	22	2.73	1.42	0.52	615	2.55	1.33	0.52	650	2.38	1.24	0.52	673
28	24	2.88	1.15	0.40	638	2.70	1.08	0.40	667	2.55	1.02	0.40	696
28	26	3.03	0.85	0.28	661	2.85	0.80	0.28	690	2.68	0.75	0.28	719
29	18	2.45	1.96	0.80	568	2.25	1.80	0.80	603	2.08	1.66	0.80	626
29	20	2.58	1.75	0.68	592	2.40	1.63	0.68	621	2.23	1.51	0.68	655
29	22	2.73	1.53	0.56	615	2.55	1.43	0.56	650	2.38	1.33	0.56	673
29	24	2.88	1.27	0.44	638	2.70	1.19	0.44	667	2.55	1.12	0.44	696
29	26	3.03	0.97	0.32	661	2.85	0.91	0.32	690	2.68	0.86	0.32	719
30	18	2.45	2.06	0.84	568	2.25	1.89	0.84	603	2.08	1.74	0.84	626
30	20	2.58	1.85	0.72	592	2.40	1.73	0.72	621	2.23	1.60	0.72	655
30	22	2.73	1.64	0.60	615	2.55	1.53	0.60	650	2.38	1.43	0.60	673
30	24	2.88	1.38	0.48	638	2.70	1.30	0.48	667	2.55	1.22	0.48	696
30	26	3.03	1.09	0.36	661	2.85	1.03	0.36	690	2.68	0.96	0.36	719
31	18	2.45	2.16	0.88	568	2.25	1.98	0.88	603	2.08	1.83	0.88	626
31	20	2.58	1.96	0.76	592	2.40	1.82	0.76	621	2.23	1.69	0.76	655
31	22	2.73	1.74	0.64	615	2.55	1.63	0.64	650	2.38	1.52	0.64	673
31	24	2.88	1.50	0.52	638	2.70	1.40	0.52	667	2.55	1.33	0.52	696
31	26	3.03	1.21	0.40	661	2.85	1.14	0.40	690	2.68	1.07	0.40	719
32	18	2.45	2.25	0.92	568	2.25	2.07	0.92	603	2.08	1.91	0.92	626
32	20	2.58	2.06	0.80	592	2.40	1.92	0.80	621	2.23	1.78	0.80	655
32	22	2.73	1.85	0.68	615	2.55	1.73	0.68	650	2.38	1.62	0.68	673
32	24	2.88	1.61	0.56	638	2.70	1.51	0.56	667	2.55	1.43	0.56	696
32	26	3.03	1.33	0.44	661	2.85	1.25	0.44	690	2.68	1.18	0.44	719

NOTE Q : Total capacity (kW) SHF : Sensible heat factor DB : Dry-bulb temperature
 SHC : Sensible heat capacity (kW) INPUT : Total power input (W) WB : Wet-bulb temperature

PERFORMANCE DATA

COOLING operation Rated frequency 77Hz

MFZ-KA35VA/ SUZ-KA35VA.TH, SUZ-KA35VAH.TH

CAPACITY : 3.5(kW) SHF : 0.65 INPUT : 1090(W)

		OUTDOOR DB(°C)															
INDOOR DB(°C)	INDOOR WB(°C)	21				25				27				30			
		Q	SHC	SHF	INPUT	Q	SHC	SHF	INPUT	Q	SHC	SHF	INPUT	Q	SHC	SHF	INPUT
21	18	4.11	1.93	0.47	872	3.94	1.85	0.47	916	3.78	1.78	0.47	959	3.64	1.71	0.47	1003
21	20	4.29	1.50	0.35	916	4.11	1.44	0.35	970	3.99	1.40	0.35	992	3.85	1.35	0.35	1036
22	18	4.11	2.10	0.51	872	3.94	2.01	0.51	916	3.78	1.93	0.51	959	3.64	1.86	0.51	1003
22	20	4.29	1.67	0.39	916	4.11	1.60	0.39	970	3.99	1.56	0.39	992	3.85	1.50	0.39	1036
22	22	4.46	1.20	0.27	948	4.31	1.16	0.27	1008	4.20	1.13	0.27	1036	4.03	1.09	0.27	1079
23	18	4.11	2.26	0.55	872	3.94	2.17	0.55	916	3.78	2.08	0.55	959	3.64	2.00	0.55	1003
23	20	4.29	1.84	0.43	916	4.11	1.77	0.43	970	3.99	1.72	0.43	992	3.85	1.66	0.43	1036
23	22	4.46	1.38	0.31	948	4.31	1.33	0.31	1008	4.20	1.30	0.31	1036	4.03	1.25	0.31	1079
24	18	4.11	2.43	0.59	872	3.94	2.32	0.59	916	3.78	2.23	0.59	959	3.64	2.15	0.59	1003
24	20	4.29	2.02	0.47	916	4.11	1.93	0.47	970	3.99	1.88	0.47	992	3.85	1.81	0.47	1036
24	22	4.46	1.56	0.35	948	4.31	1.51	0.35	1008	4.20	1.47	0.35	1036	4.03	1.41	0.35	1079
24	24	4.69	1.08	0.23	992	4.52	1.04	0.23	1046	4.41	1.01	0.23	1079	4.27	0.98	0.23	1134
25	18	4.11	2.59	0.63	872	3.94	2.48	0.63	916	3.78	2.38	0.63	959	3.64	2.29	0.63	1003
25	20	4.29	2.19	0.51	916	4.11	2.10	0.51	970	3.99	2.03	0.51	992	3.85	1.96	0.51	1036
25	22	4.46	1.74	0.39	948	4.31	1.68	0.39	1008	4.20	1.64	0.39	1036	4.03	1.57	0.39	1079
25	24	4.69	1.27	0.27	992	4.52	1.22	0.27	1046	4.41	1.19	0.27	1079	4.27	1.15	0.27	1134
26	18	4.11	2.76	0.67	872	3.94	2.64	0.67	916	3.78	2.53	0.67	959	3.64	2.44	0.67	1003
26	20	4.29	2.36	0.55	916	4.11	2.26	0.55	970	3.99	2.19	0.55	992	3.85	2.12	0.55	1036
26	22	4.46	1.92	0.43	948	4.31	1.85	0.43	1008	4.20	1.81	0.43	1036	4.03	1.73	0.43	1079
26	24	4.69	1.45	0.31	992	4.52	1.40	0.31	1046	4.41	1.37	0.31	1079	4.27	1.32	0.31	1134
26	26	4.83	0.92	0.19	1046	4.69	0.89	0.19	1101	4.62	0.88	0.19	1134	4.48	0.85	0.19	1166
27	18	4.11	2.92	0.71	872	3.94	2.80	0.71	916	3.78	2.68	0.71	959	3.64	2.58	0.71	1003
27	20	4.29	2.53	0.59	916	4.11	2.43	0.59	970	3.99	2.35	0.59	992	3.85	2.27	0.59	1036
27	22	4.46	2.10	0.47	948	4.31	2.02	0.47	1008	4.20	1.97	0.47	1036	4.03	1.89	0.47	1079
27	24	4.69	1.64	0.35	992	4.52	1.58	0.35	1046	4.41	1.54	0.35	1079	4.27	1.49	0.35	1134
27	26	4.83	1.11	0.23	1046	4.69	1.08	0.23	1101	4.62	1.06	0.23	1134	4.48	1.03	0.23	1166
28	18	4.11	3.08	0.75	872	3.94	2.95	0.75	916	3.78	2.84	0.75	959	3.64	2.73	0.75	1003
28	20	4.29	2.70	0.63	916	4.11	2.59	0.63	970	3.99	2.51	0.63	992	3.85	2.43	0.63	1036
28	22	4.46	2.28	0.51	948	4.31	2.20	0.51	1008	4.20	2.14	0.51	1036	4.03	2.05	0.51	1079
28	24	4.69	1.83	0.39	992	4.52	1.76	0.39	1046	4.41	1.72	0.39	1079	4.27	1.67	0.39	1134
28	26	4.83	1.30	0.27	1046	4.69	1.27	0.27	1101	4.62	1.25	0.27	1134	4.48	1.21	0.27	1166
29	18	4.11	3.25	0.79	872	3.94	3.11	0.79	916	3.78	2.99	0.79	959	3.64	2.88	0.79	1003
29	20	4.29	2.87	0.67	916	4.11	2.76	0.67	970	3.99	2.67	0.67	992	3.85	2.58	0.67	1036
29	22	4.46	2.45	0.55	948	4.31	2.37	0.55	1008	4.20	2.31	0.55	1036	4.03	2.21	0.55	1079
29	24	4.69	2.02	0.43	992	4.52	1.94	0.43	1046	4.41	1.90	0.43	1079	4.27	1.84	0.43	1134
29	26	4.83	1.50	0.31	1046	4.69	1.45	0.31	1101	4.62	1.43	0.31	1134	4.48	1.39	0.31	1166
30	18	4.11	3.41	0.83	872	3.94	3.27	0.83	916	3.78	3.14	0.83	959	3.64	3.02	0.83	1003
30	20	4.29	3.04	0.71	916	4.11	2.92	0.71	970	3.99	2.83	0.71	992	3.85	2.73	0.71	1036
30	22	4.46	2.63	0.59	948	4.31	2.54	0.59	1008	4.20	2.48	0.59	1036	4.03	2.37	0.59	1079
30	24	4.69	2.20	0.47	992	4.52	2.12	0.47	1046	4.41	2.07	0.47	1079	4.27	2.01	0.47	1134
30	26	4.83	1.69	0.35	1046	4.69	1.64	0.35	1101	4.62	1.62	0.35	1134	4.48	1.57	0.35	1166
31	18	4.11	3.58	0.87	872	3.94	3.43	0.87	916	3.78	3.29	0.87	959	3.64	3.17	0.87	1003
31	20	4.29	3.22	0.75	916	4.11	3.08	0.75	970	3.99	2.99	0.75	992	3.85	2.89	0.75	1036
31	22	4.46	2.81	0.63	948	4.31	2.71	0.63	1008	4.20	2.65	0.63	1036	4.03	2.54	0.63	1079
31	24	4.69	2.39	0.51	992	4.52	2.30	0.51	1046	4.41	2.25	0.51	1079	4.27	2.18	0.51	1134
31	26	4.83	1.88	0.39	1046	4.69	1.83	0.39	1101	4.62	1.80	0.39	1134	4.48	1.75	0.39	1166
32	18	4.11	3.74	0.91	872	3.94	3.58	0.91	916	3.78	3.44	0.91	959	3.64	3.31	0.91	1003
32	20	4.29	3.39	0.79	916	4.11	3.25	0.79	970	3.99	3.15	0.79	992	3.85	3.04	0.79	1036
32	22	4.46	2.99	0.67	948	4.31	2.88	0.67	1008	4.20	2.81	0.67	1036	4.03	2.70	0.67	1079
32	24	4.69	2.58	0.55	992	4.52	2.48	0.55	1046	4.41	2.43	0.55	1079	4.27	2.35	0.55	1134
32	26	4.83	2.08	0.43	1046	4.69	2.02	0.43	1101	4.62	1.99	0.43	1134	4.48	1.93	0.43	1166

NOTE Q : Total capacity (kW) SHF : Sensible heat factor DB : Dry-bulb temperature
 SHC : Sensible heat capacity (kW) INPUT : Total power input (W) WB : Wet-bulb temperature

PERFORMANCE DATA

COOLING operation Rated frequency 77Hz

MFZ-KA35VA/ SUZ-KA35VA.TH, SUZ-KA35VAH.TH

CAPACITY : 3.5(kW) SHF : 0.65 INPUT : 1090(W)

		OUTDOOR DB(°C)											
INDOOR DB (°C)	INDOOR WB (°C)	35				40				46			
		Q	SHC	SHF	INPUT	Q	SHC	SHF	INPUT	Q	SHC	SHF	INPUT
21	18	3.43	1.61	0.47	1068	3.15	1.48	0.47	1134	2.91	1.37	0.47	1177
21	20	3.61	1.26	0.35	1112	3.36	1.18	0.35	1166	3.12	1.09	0.35	1232
22	18	3.43	1.75	0.51	1068	3.15	1.61	0.51	1134	2.91	1.48	0.51	1177
22	20	3.61	1.41	0.39	1112	3.36	1.31	0.39	1166	3.12	1.21	0.39	1232
22	22	3.82	1.03	0.27	1155	3.57	0.96	0.27	1221	3.33	0.90	0.27	1264
23	18	3.43	1.89	0.55	1068	3.15	1.73	0.55	1134	2.91	1.60	0.55	1177
23	20	3.61	1.55	0.43	1112	3.36	1.44	0.43	1166	3.12	1.34	0.43	1232
23	22	3.82	1.18	0.31	1155	3.57	1.11	0.31	1221	3.33	1.03	0.31	1264
24	18	3.43	2.02	0.59	1068	3.15	1.86	0.59	1134	2.91	1.71	0.59	1177
24	20	3.61	1.69	0.47	1112	3.36	1.58	0.47	1166	3.12	1.46	0.47	1232
24	22	3.82	1.34	0.35	1155	3.57	1.25	0.35	1221	3.33	1.16	0.35	1264
24	24	4.03	0.93	0.23	1199	3.78	0.87	0.23	1254	3.57	0.82	0.23	1308
25	18	3.43	2.16	0.63	1068	3.15	1.98	0.63	1134	2.91	1.83	0.63	1177
25	20	3.61	1.84	0.51	1112	3.36	1.71	0.51	1166	3.12	1.59	0.51	1232
25	22	3.82	1.49	0.39	1155	3.57	1.39	0.39	1221	3.33	1.30	0.39	1264
25	24	4.03	1.09	0.27	1199	3.78	1.02	0.27	1254	3.57	0.96	0.27	1308
26	18	3.43	2.30	0.67	1068	3.15	2.11	0.67	1134	2.91	1.95	0.67	1177
26	20	3.61	1.98	0.55	1112	3.36	1.85	0.55	1166	3.12	1.71	0.55	1232
26	22	3.82	1.64	0.43	1155	3.57	1.54	0.43	1221	3.33	1.43	0.43	1264
26	24	4.03	1.25	0.31	1199	3.78	1.17	0.31	1254	3.57	1.11	0.31	1308
26	26	4.24	0.80	0.19	1243	3.99	0.76	0.19	1297	3.75	0.71	0.19	1352
27	18	3.43	2.44	0.71	1068	3.15	2.24	0.71	1134	2.91	2.06	0.71	1177
27	20	3.61	2.13	0.59	1112	3.36	1.98	0.59	1166	3.12	1.84	0.59	1232
27	22	3.82	1.79	0.47	1155	3.57	1.68	0.47	1221	3.33	1.56	0.47	1264
27	24	4.03	1.41	0.35	1199	3.78	1.32	0.35	1254	3.57	1.25	0.35	1308
27	26	4.24	0.97	0.23	1243	3.99	0.92	0.23	1297	3.75	0.86	0.23	1352
28	18	3.43	2.57	0.75	1068	3.15	2.36	0.75	1134	2.91	2.18	0.75	1177
28	20	3.61	2.27	0.63	1112	3.36	2.12	0.63	1166	3.12	1.96	0.63	1232
28	22	3.82	1.95	0.51	1155	3.57	1.82	0.51	1221	3.33	1.70	0.51	1264
28	24	4.03	1.57	0.39	1199	3.78	1.47	0.39	1254	3.57	1.39	0.39	1308
28	26	4.24	1.14	0.27	1243	3.99	1.08	0.27	1297	3.75	1.01	0.27	1352
29	18	3.43	2.71	0.79	1068	3.15	2.49	0.79	1134	2.91	2.29	0.79	1177
29	20	3.61	2.42	0.67	1112	3.36	2.25	0.67	1166	3.12	2.09	0.67	1232
29	22	3.82	2.10	0.55	1155	3.57	1.96	0.55	1221	3.33	1.83	0.55	1264
29	24	4.03	1.73	0.43	1199	3.78	1.63	0.43	1254	3.57	1.54	0.43	1308
29	26	4.24	1.31	0.31	1243	3.99	1.24	0.31	1297	3.75	1.16	0.31	1352
30	18	3.43	2.85	0.83	1068	3.15	2.61	0.83	1134	2.91	2.41	0.83	1177
30	20	3.61	2.56	0.71	1112	3.36	2.39	0.71	1166	3.12	2.21	0.71	1232
30	22	3.82	2.25	0.59	1155	3.57	2.11	0.59	1221	3.33	1.96	0.59	1264
30	24	4.03	1.89	0.47	1199	3.78	1.78	0.47	1254	3.57	1.68	0.47	1308
30	26	4.24	1.48	0.35	1243	3.99	1.40	0.35	1297	3.75	1.31	0.35	1352
31	18	3.43	2.98	0.87	1068	3.15	2.74	0.87	1134	2.91	2.53	0.87	1177
31	20	3.61	2.70	0.75	1112	3.36	2.52	0.75	1166	3.12	2.34	0.75	1232
31	22	3.82	2.40	0.63	1155	3.57	2.25	0.63	1221	3.33	2.09	0.63	1264
31	24	4.03	2.05	0.51	1199	3.78	1.93	0.51	1254	3.57	1.82	0.51	1308
31	26	4.24	1.65	0.39	1243	3.99	1.56	0.39	1297	3.75	1.46	0.39	1352
32	18	3.43	3.12	0.91	1068	3.15	2.87	0.91	1134	2.91	2.64	0.91	1177
32	20	3.61	2.85	0.79	1112	3.36	2.65	0.79	1166	3.12	2.46	0.79	1232
32	22	3.82	2.56	0.67	1155	3.57	2.39	0.67	1221	3.33	2.23	0.67	1264
32	24	4.03	2.21	0.55	1199	3.78	2.08	0.55	1254	3.57	1.96	0.55	1308
32	26	4.24	1.82	0.43	1243	3.99	1.72	0.43	1297	3.75	1.61	0.43	1352

NOTE Q : Total capacity (kW) SHF : Sensible heat factor DB : Dry-bulb temperature
 SHC : Sensible heat capacity (kW) INPUT : Total power input (W) WB : Wet-bulb temperature

PERFORMANCE DATA

COOLING operation Rated frequency 75Hz

MFZ-KA50VA/ SUZ-KA50VA.TH

CAPACITY : 4.8(kW) SHF : 0.63 INPUT : 1550(W)

		OUTDOOR DB(°C)															
INDOOR DB(°C)	INDOOR WB(°C)	21				25				27				30			
		Q	SHC	SHF	INPUT	Q	SHC	SHF	INPUT	Q	SHC	SHF	INPUT	Q	SHC	SHF	INPUT
21	18	5.64	2.54	0.45	1240	5.40	2.43	0.45	1302	5.18	2.33	0.45	1364	4.99	2.25	0.45	1426
21	20	5.88	1.94	0.33	1302	5.64	1.86	0.33	1380	5.47	1.81	0.33	1411	5.28	1.74	0.33	1473
22	18	5.64	2.76	0.49	1240	5.40	2.65	0.49	1302	5.18	2.54	0.49	1364	4.99	2.45	0.49	1426
22	20	5.88	2.18	0.37	1302	5.64	2.09	0.37	1380	5.47	2.02	0.37	1411	5.28	1.95	0.37	1473
22	22	6.12	1.53	0.25	1349	5.90	1.48	0.25	1434	5.76	1.44	0.25	1473	5.52	1.38	0.25	1535
23	18	5.64	2.99	0.53	1240	5.40	2.86	0.53	1302	5.18	2.75	0.53	1364	4.99	2.65	0.53	1426
23	20	5.88	2.41	0.41	1302	5.64	2.31	0.41	1380	5.47	2.24	0.41	1411	5.28	2.16	0.41	1473
23	22	6.12	1.77	0.29	1349	5.90	1.71	0.29	1434	5.76	1.67	0.29	1473	5.52	1.60	0.29	1535
24	18	5.64	3.21	0.57	1240	5.40	3.08	0.57	1302	5.18	2.95	0.57	1364	4.99	2.85	0.57	1426
24	20	5.88	2.65	0.45	1302	5.64	2.54	0.45	1380	5.47	2.46	0.45	1411	5.28	2.38	0.45	1473
24	22	6.12	2.02	0.33	1349	5.90	1.95	0.33	1434	5.76	1.90	0.33	1473	5.52	1.82	0.33	1535
24	24	6.43	1.35	0.21	1411	6.19	1.30	0.21	1488	6.05	1.27	0.21	1535	5.86	1.23	0.21	1612
25	18	5.64	3.44	0.61	1240	5.40	3.29	0.61	1302	5.18	3.16	0.61	1364	4.99	3.05	0.61	1426
25	20	5.88	2.88	0.49	1302	5.64	2.76	0.49	1380	5.47	2.68	0.49	1411	5.28	2.59	0.49	1473
25	22	6.12	2.26	0.37	1349	5.90	2.18	0.37	1434	5.76	2.13	0.37	1473	5.52	2.04	0.37	1535
25	24	6.43	1.61	0.25	1411	6.19	1.55	0.25	1488	6.05	1.51	0.25	1535	5.86	1.46	0.25	1612
26	18	5.64	3.67	0.65	1240	5.40	3.51	0.65	1302	5.18	3.37	0.65	1364	4.99	3.24	0.65	1426
26	20	5.88	3.12	0.53	1302	5.64	2.99	0.53	1380	5.47	2.90	0.53	1411	5.28	2.80	0.53	1473
26	22	6.12	2.51	0.41	1349	5.90	2.42	0.41	1434	5.76	2.36	0.41	1473	5.52	2.26	0.41	1535
26	24	6.43	1.87	0.29	1411	6.19	1.80	0.29	1488	6.05	1.75	0.29	1535	5.86	1.70	0.29	1612
26	26	6.62	1.13	0.17	1488	6.43	1.09	0.17	1566	6.34	1.08	0.17	1612	6.14	1.04	0.17	1659
27	18	5.64	3.89	0.69	1240	5.40	3.73	0.69	1302	5.18	3.58	0.69	1364	4.99	3.44	0.69	1426
27	20	5.88	3.35	0.57	1302	5.64	3.21	0.57	1380	5.47	3.12	0.57	1411	5.28	3.01	0.57	1473
27	22	6.12	2.75	0.45	1349	5.90	2.66	0.45	1434	5.76	2.59	0.45	1473	5.52	2.48	0.45	1535
27	24	6.43	2.12	0.33	1411	6.19	2.04	0.33	1488	6.05	2.00	0.33	1535	5.86	1.93	0.33	1612
27	26	6.62	1.39	0.21	1488	6.43	1.35	0.21	1566	6.34	1.33	0.21	1612	6.14	1.29	0.21	1659
28	18	5.64	4.12	0.73	1240	5.40	3.94	0.73	1302	5.18	3.78	0.73	1364	4.99	3.64	0.73	1426
28	20	5.88	3.59	0.61	1302	5.64	3.44	0.61	1380	5.47	3.34	0.61	1411	5.28	3.22	0.61	1473
28	22	6.12	3.00	0.49	1349	5.90	2.89	0.49	1434	5.76	2.82	0.49	1473	5.52	2.70	0.49	1535
28	24	6.43	2.38	0.37	1411	6.19	2.29	0.37	1488	6.05	2.24	0.37	1535	5.86	2.17	0.37	1612
28	26	6.62	1.66	0.25	1488	6.43	1.61	0.25	1566	6.34	1.58	0.25	1612	6.14	1.54	0.25	1659
29	18	5.64	4.34	0.77	1240	5.40	4.16	0.77	1302	5.18	3.99	0.77	1364	4.99	3.84	0.77	1426
29	20	5.88	3.82	0.65	1302	5.64	3.67	0.65	1380	5.47	3.56	0.65	1411	5.28	3.43	0.65	1473
29	22	6.12	3.24	0.53	1349	5.90	3.13	0.53	1434	5.76	3.05	0.53	1473	5.52	2.93	0.53	1535
29	24	6.43	2.64	0.41	1411	6.19	2.54	0.41	1488	6.05	2.48	0.41	1535	5.86	2.40	0.41	1612
29	26	6.62	1.92	0.29	1488	6.43	1.87	0.29	1566	6.34	1.84	0.29	1612	6.14	1.78	0.29	1659
30	18	5.64	4.57	0.81	1240	5.40	4.37	0.81	1302	5.18	4.20	0.81	1364	4.99	4.04	0.81	1426
30	20	5.88	4.06	0.69	1302	5.64	3.89	0.69	1380	5.47	3.78	0.69	1411	5.28	3.64	0.69	1473
30	22	6.12	3.49	0.57	1349	5.90	3.37	0.57	1434	5.76	3.28	0.57	1473	5.52	3.15	0.57	1535
30	24	6.43	2.89	0.45	1411	6.19	2.79	0.45	1488	6.05	2.72	0.45	1535	5.86	2.64	0.45	1612
30	26	6.62	2.19	0.33	1488	6.43	2.12	0.33	1566	6.34	2.09	0.33	1612	6.14	2.03	0.33	1659
31	18	5.64	4.79	0.85	1240	5.40	4.59	0.85	1302	5.18	4.41	0.85	1364	4.99	4.24	0.85	1426
31	20	5.88	4.29	0.73	1302	5.64	4.12	0.73	1380	5.47	3.99	0.73	1411	5.28	3.85	0.73	1473
31	22	6.12	3.73	0.61	1349	5.90	3.60	0.61	1434	5.76	3.51	0.61	1473	5.52	3.37	0.61	1535
31	24	6.43	3.15	0.49	1411	6.19	3.03	0.49	1488	6.05	2.96	0.49	1535	5.86	2.87	0.49	1612
31	26	6.62	2.45	0.37	1488	6.43	2.38	0.37	1566	6.34	2.34	0.37	1612	6.14	2.27	0.37	1659
32	18	5.64	5.02	0.89	1240	5.40	4.81	0.89	1302	5.18	4.61	0.89	1364	4.99	4.44	0.89	1426
32	20	5.88	4.53	0.77	1302	5.64	4.34	0.77	1380	5.47	4.21	0.77	1411	5.28	4.07	0.77	1473
32	22	6.12	3.98	0.65	1349	5.90	3.84	0.65	1434	5.76	3.74	0.65	1473	5.52	3.59	0.65	1535
32	24	6.43	3.41	0.53	1411	6.19	3.28	0.53	1488	6.05	3.21	0.53	1535	5.86	3.10	0.53	1612
32	26	6.62	2.72	0.41	1488	6.43	2.64	0.41	1566	6.34	2.60	0.41	1612	6.14	2.52	0.41	1659

NOTE Q : Total capacity (kW) SHF : Sensible heat factor DB : Dry-bulb temperature
 SHC : Sensible heat capacity (kW) INPUT : Total power input (W) WB : Wet-bulb temperature

PERFORMANCE DATA

COOLING operation Rated frequency 75Hz

MFZ-KA50VA/ SUZ-KA50VA.TH

CAPACITY : 4.8(kW) SHF : 0.63 INPUT : 1550(W)

		OUTDOOR DB(°C)											
INDOOR DB (°C)	INDOOR WB (°C)	35				40				46			
		Q	SHC	SHF	INPUT	Q	SHC	SHF	INPUT	Q	SHC	SHF	INPUT
21	18	4.70	2.12	0.45	1519	4.32	1.94	0.45	1612	3.98	1.79	0.45	1674
21	20	4.94	1.63	0.33	1581	4.61	1.52	0.33	1659	4.27	1.41	0.33	1752
22	18	4.70	2.30	0.49	1519	4.32	2.12	0.49	1612	3.98	1.95	0.49	1674
22	20	4.94	1.83	0.37	1581	4.61	1.70	0.37	1659	4.27	1.58	0.37	1752
22	22	5.23	1.31	0.25	1643	4.90	1.22	0.25	1736	4.56	1.14	0.25	1798
23	18	4.70	2.49	0.53	1519	4.32	2.29	0.53	1612	3.98	2.11	0.53	1674
23	20	4.94	2.03	0.41	1581	4.61	1.89	0.41	1659	4.27	1.75	0.41	1752
23	22	5.23	1.52	0.29	1643	4.90	1.42	0.29	1736	4.56	1.32	0.29	1798
24	18	4.70	2.68	0.57	1519	4.32	2.46	0.57	1612	3.98	2.27	0.57	1674
24	20	4.94	2.22	0.45	1581	4.61	2.07	0.45	1659	4.27	1.92	0.45	1752
24	22	5.23	1.73	0.33	1643	4.90	1.62	0.33	1736	4.56	1.50	0.33	1798
24	24	5.52	1.16	0.21	1705	5.18	1.09	0.21	1783	4.90	1.03	0.21	1860
25	18	4.70	2.87	0.61	1519	4.32	2.64	0.61	1612	3.98	2.43	0.61	1674
25	20	4.94	2.42	0.49	1581	4.61	2.26	0.49	1659	4.27	2.09	0.49	1752
25	22	5.23	1.94	0.37	1643	4.90	1.81	0.37	1736	4.56	1.69	0.37	1798
25	24	5.52	1.38	0.25	1705	5.18	1.30	0.25	1783	4.90	1.22	0.25	1860
26	18	4.70	3.06	0.65	1519	4.32	2.81	0.65	1612	3.98	2.59	0.65	1674
26	20	4.94	2.62	0.53	1581	4.61	2.44	0.53	1659	4.27	2.26	0.53	1752
26	22	5.23	2.15	0.41	1643	4.90	2.01	0.41	1736	4.56	1.87	0.41	1798
26	24	5.52	1.60	0.29	1705	5.18	1.50	0.29	1783	4.90	1.42	0.29	1860
26	26	5.81	0.99	0.17	1767	5.47	0.93	0.17	1845	5.14	0.87	0.17	1922
27	18	4.70	3.25	0.69	1519	4.32	2.98	0.69	1612	3.98	2.75	0.69	1674
27	20	4.94	2.82	0.57	1581	4.61	2.63	0.57	1659	4.27	2.44	0.57	1752
27	22	5.23	2.35	0.45	1643	4.90	2.20	0.45	1736	4.56	2.05	0.45	1798
27	24	5.52	1.82	0.33	1705	5.18	1.71	0.33	1783	4.90	1.62	0.33	1860
27	26	5.81	1.22	0.21	1767	5.47	1.15	0.21	1845	5.14	1.08	0.21	1922
28	18	4.70	3.43	0.73	1519	4.32	3.15	0.73	1612	3.98	2.91	0.73	1674
28	20	4.94	3.02	0.61	1581	4.61	2.81	0.61	1659	4.27	2.61	0.61	1752
28	22	5.23	2.56	0.49	1643	4.90	2.40	0.49	1736	4.56	2.23	0.49	1798
28	24	5.52	2.04	0.37	1705	5.18	1.92	0.37	1783	4.90	1.81	0.37	1860
28	26	5.81	1.45	0.25	1767	5.47	1.37	0.25	1845	5.14	1.28	0.25	1922
29	18	4.70	3.62	0.77	1519	4.32	3.33	0.77	1612	3.98	3.07	0.77	1674
29	20	4.94	3.21	0.65	1581	4.61	3.00	0.65	1659	4.27	2.78	0.65	1752
29	22	5.23	2.77	0.53	1643	4.90	2.59	0.53	1736	4.56	2.42	0.53	1798
29	24	5.52	2.26	0.41	1705	5.18	2.13	0.41	1783	4.90	2.01	0.41	1860
29	26	5.81	1.68	0.29	1767	5.47	1.59	0.29	1845	5.14	1.49	0.29	1922
30	18	4.70	3.81	0.81	1519	4.32	3.50	0.81	1612	3.98	3.23	0.81	1674
30	20	4.94	3.41	0.69	1581	4.61	3.18	0.69	1659	4.27	2.95	0.69	1752
30	22	5.23	2.98	0.57	1643	4.90	2.79	0.57	1736	4.56	2.60	0.57	1798
30	24	5.52	2.48	0.45	1705	5.18	2.33	0.45	1783	4.90	2.20	0.45	1860
30	26	5.81	1.92	0.33	1767	5.47	1.81	0.33	1845	5.14	1.69	0.33	1922
31	18	4.70	4.00	0.85	1519	4.32	3.67	0.85	1612	3.98	3.39	0.85	1674
31	20	4.94	3.61	0.73	1581	4.61	3.36	0.73	1659	4.27	3.12	0.73	1752
31	22	5.23	3.19	0.61	1643	4.90	2.99	0.61	1736	4.56	2.78	0.61	1798
31	24	5.52	2.70	0.49	1705	5.18	2.54	0.49	1783	4.90	2.40	0.49	1860
31	26	5.81	2.15	0.37	1767	5.47	2.02	0.37	1845	5.14	1.90	0.37	1922
32	18	4.70	4.19	0.89	1519	4.32	3.84	0.89	1612	3.98	3.55	0.89	1674
32	20	4.94	3.81	0.77	1581	4.61	3.55	0.77	1659	4.27	3.29	0.77	1752
32	22	5.23	3.40	0.65	1643	4.90	3.18	0.65	1736	4.56	2.96	0.65	1798
32	24	5.52	2.93	0.53	1705	5.18	2.75	0.53	1783	4.90	2.59	0.53	1860
32	26	5.81	2.38	0.41	1767	5.47	2.24	0.41	1845	5.14	2.11	0.41	1922

NOTE Q : Total capacity (kW) SHF : Sensible heat factor DB : Dry-bulb temperature
 SHC : Sensible heat capacity (kW) INPUT : Total power input (W) WB : Wet-bulb temperature

PERFORMANCE DATA

HEATING operation

MFZ-KA25VA/ SUZ-KA25VA(H).TH Rated frequency 80Hz

CAPACITY : 3.4(kW) INPUT : 835(W)

INDOOR DB(°C)		OUTDOOR WB(°C)													
		-10		-5		0		5		10		15		20	
		Q	INPUT	Q	INPUT	Q	INPUT	Q	INPUT	Q	INPUT	Q	INPUT	Q	INPUT
15	2.14	534	2.58	651	3.03	735	3.47	793	3.91	843	4.32	868	4.76	885	
21	2.04	585	2.45	693	2.89	868	3.30	827	3.74	868	4.15	893	4.57	927	
26	1.84	626	2.28	735	2.69	810	3.13	868	3.57	910	3.98	935	4.42	960	

MFZ-KA35VA/ SUZ-KA35VA(H).TH Rated frequency 74Hz

CAPACITY : 4.0(kW) INPUT : 1100(W)

INDOOR DB(°C)		OUTDOOR WB(°C)													
		-10		-5		0		5		10		15		20	
		Q	INPUT	Q	INPUT	Q	INPUT	Q	INPUT	Q	INPUT	Q	INPUT	Q	INPUT
15	2.52	715	3.04	858	3.56	968	4.08	1045	4.60	1111	5.08	1144	5.60	1166	
21	2.40	770	2.88	913	3.40	1012	3.88	1089	4.40	1144	4.88	1177	5.38	1221	
26	2.16	825	2.68	968	3.16	1067	3.68	1144	4.20	1199	4.68	1232	5.20	1265	

MFZ-KA50VA/ SUZ-KA50VA.TH Rated frequency 79Hz

CAPACITY : 6.0(kW) INPUT : 1860(W)

INDOOR DB(°C)		OUTDOOR WB(°C)													
		-10		-5		0		5		10		15		20	
		Q	INPUT	Q	INPUT	Q	INPUT	Q	INPUT	Q	INPUT	Q	INPUT	Q	INPUT
15	3.78	1209	4.56	1451	5.34	1637	6.12	1767	6.90	1879	7.62	1934	8.40	1972	
21	3.60	1302	4.32	1544	5.10	1711	5.82	1841	6.60	1934	7.32	1990	8.07	2065	
26	3.24	1395	4.02	1637	4.74	1804	5.52	1934	6.30	2027	7.02	2083	7.80	2139	

NOTE Q:Total capacity (kW) INPUT:Total power input (W) DB : Dry-bulb temperature WB : Wet-bulb temperature

**MFZ-KA25VA
MFZ-KA35VA
MFZ-KA50VA**

9-1. TIMER SHORT MODE

For service, set time can be shortened by short circuit of JPG and JPS on the electronic control P.C. board.
The time will be shortened as follows. (Refer to 10-7.)

Set time : 1-minute → 1-second

Set time : 3-minute → 3-second (It takes 3 minutes for the compressor to start operation. However, the starting time is shortened by short circuit of JPG and JPS.)

9-2. P.C. BOARD MODIFICATION FOR INDIVIDUAL OPERATION

A maximum of 4 indoor units with wireless remote controllers can be used in a room.

In this case, to operate each indoor unit individually by each remote controller, both the P.C. boards of remote controller and the electronic control P.C. boards must be modified according to the number of the indoor unit.

How to modify the remote controller P.C. board

Remove batteries before modification.

The board has a print as shown below :

Remote controller model : KM05G

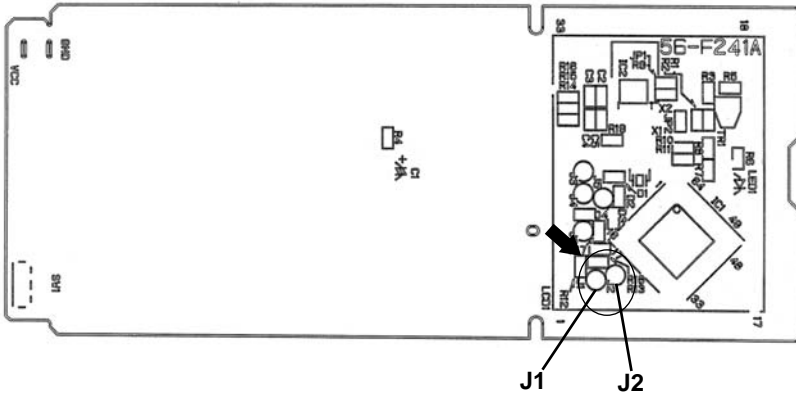

NOTE : For remodelling, take out the batteries and push the OPERATE/STOP(ON/OFF) button twice or 3 times at first. After finish remodelling, put back the batteries then press the RESET button.

The P.C. board has the print "J1" and "J2". Solder "J1" and "J2" according to the number of indoor unit as shown in Table 1. After modification, press the RESET button.

Table 1

	1 unit operation	2 units operation	3 units operation	4 units operation
No. 1 unit	No modification	Same as at left	Same as at left	Same as at left
No. 2 unit	–	Solder J1	Same as at left	Same as at left
No. 3 unit	–	–	Solder J2	Same as at left
No. 4 unit	–	–	–	Solder both J1 and J2

How to modify the electronic control P.C. board

Turn OFF the power supply before modification. Cut off "JR05" and "JR06" on the electronic control P.C. board according to the number of indoor unit as shown in Table 2. (Refer to 9-7.)

Table 2

	JR05	JR06
No. 1 unit	No modification	No modification
No. 2 unit	Cut off JR05	No modification
No. 3 unit	No modification	Cut off JR06
No. 4 unit	Cut off JR05	Cut off JR06

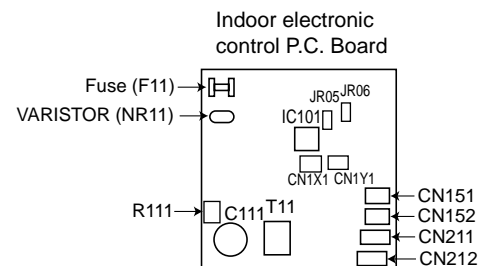

NOTE : After modification, turn ON the power supply and with the remote controller headed towards the indoor unit, press the OPERATE/STOP(ON/OFF) button. If one or two beeps is heard from the indoor unit, modification is completed correctly.

9-3. AUTO RESTART FUNCTION

When the indoor unit is controlled with the remote controller, the operation mode, the set temperature, and the fan speed are memorized by the indoor electronic control P.C. board. The "AUTO RESTART FUNCTION" sets to work the moment power has restored after power failure. Then, the unit will restart automatically.

Operation

- ① If the main power has been cut, the operation settings remain.
- ② After the power is restored, the unit restarts automatically according to the memory.
(However, it takes at least 3 minutes for the compressor to start running.)

How to release "AUTO RESTART FUNCTION"

- ① Turn off the main power for the unit.
- ② Solder the Jumper wire to JR07 on the indoor electronic control P.C. board. (Refer to 10-7.)

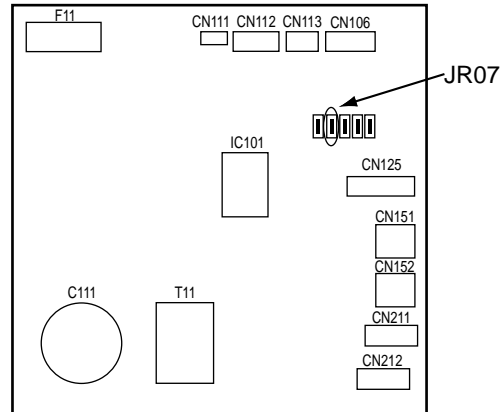

NOTE:

- The operation settings are memorized when 10 seconds have passed after the indoor unit was operated with the remote controller.
- If main power is turned OFF or a power failure occurs while AUTO START/STOP timer is active, the timer setting is cancelled.
- If the unit has been off with the remote controller before power failure, the auto restart function does not work as the power button of the remote controller is off.
- To prevent breaker tripping due to the rush of starting current, systematize other home appliance not to turn on at the same time.
- When some air conditioners are connected to the same supply system, if they are operated before power failure, the starting current of all the compressors may flow simultaneously at restart.
Therefore, the special counter-measures are required to prevent the main voltage-drop or the rush of the starting current by adding to the system that allows the units to start one by one.

MFZ-KA25VA MFZ-KA35VA MFZ-KA50VA

10-1. Cautions on troubleshooting

1. Before troubleshooting, check the following:

- 1) Check the power supply voltage.
- 2) Check the indoor/outdoor connecting wire for mis-wiring.

2. Take care the following during servicing.

- 1) Before servicing the air conditioner, be sure to turn off the unit first with the remote controller, and then after confirming the horizontal vane is closed, turn off the breaker and / or disconnect the power plug.
- 2) Be sure to turn OFF the power supply before removing the front panel, the cabinet, the top panel, and the electronic control P.C. board.
- 3) When removing the electronic control P.C. board, hold the edge of the board with care NOT to apply stress on the components.
- 4) When connecting or disconnecting the connectors, hold the housing of the connector. DO NOT pull the lead wires.

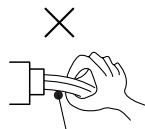

Lead wiring

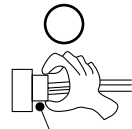

Housing point

3. Troubleshooting procedure

- 1) First, check if the OPERATION INDICATOR lamp on the indoor unit is flashing on and off to indicate an abnormality. To make sure, check how many times the abnormality indication is flashing on and off before starting service work.
- 2) Before servicing check that the connector and terminal are connected properly.
- 3) If the electronic control P.C. board is supposed to be defective, check the copper foil pattern for disconnection and the components for bursting and discoloration.
- 4) When troubleshooting, refer to 10-2., 10-3. and 10-4.

4. How to replace batteries

Weak batteries may cause the remote controller malfunction.

In this case, replace the batteries to operate the remote controller normally.

- ① Remove the front lid and insert batteries. Then reattach the front lid.

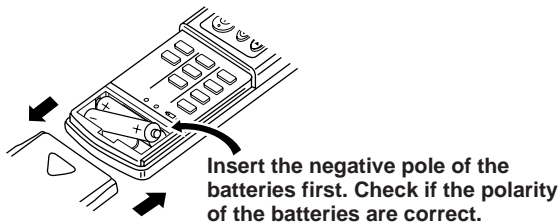

Insert the negative pole of the batteries first. Check if the polarity of the batteries are correct.

- ② Press RESET button with tip end of ball point pen or the like, and then use the remote controller.

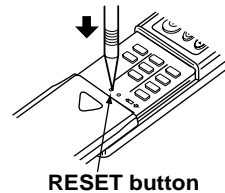

RESET button

NOTE : 1. If RESET button is not pressed, the remote controller may not operate correctly.

2. This remote controller has a circuit to automatically reset the microcomputer when batteries are replaced. This function is equipped to prevent the microcomputer from malfunctioning due to the voltage drop caused by the battery replacement.

INFORMATION FOR MULTI SYSTEM AIR CONDITIONER

OUTDOOR UNIT : MXZ series

Multi system air conditioner can connect two or more indoor units with one outdoor unit.

- Unit won't operate in case the total capacity of indoor units exceeds the capacity of outdoor units. Do not connect indoor units beyond the outdoor unit capacity.

Operation indicator lamp flashes as shown in the figure below.

- When you try to operate two or more indoor units with one outdoor unit simultaneously, one for the cooling and the other for heating, the operation mode of the indoor unit that operates earlier is selected. The other indoor units will start the operation later cannot operate, indicating as shown in the figure below. In this case, please set all the indoor units to the same operation mode.

OPERATION INDICATOR

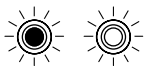

Lighted (Green)



Blinking (Green or Orange)



Blinking green : Standby for normal operation
Blinking orange : Standby for i-save operation



Not lighted

- When indoor units start operation while the defrosting of outdoor unit is being done, it takes a few minutes (max. 10 minutes) to blow out the warm air.

- In heating operation, even though the indoor unit is not in operation, the room may get warm or the sound of refrigerant flowing may be heard. This is not a malfunction. The refrigerant continuously into it causes this.

10-2. Failure mode recall function

Outline of the function

This air conditioner can memorize the abnormal condition which has occurred once.

Even though OPERATION INDICATOR lamp indication listed on the troubleshooting check table (10-4.) disappears, the memorized failure details can be recalled.

This mode is very useful when the unit needs to be repaired for the abnormality which doesn't recur.

1. Flow chart of failure mode recall function for the indoor/outdoor unit

Operational procedure

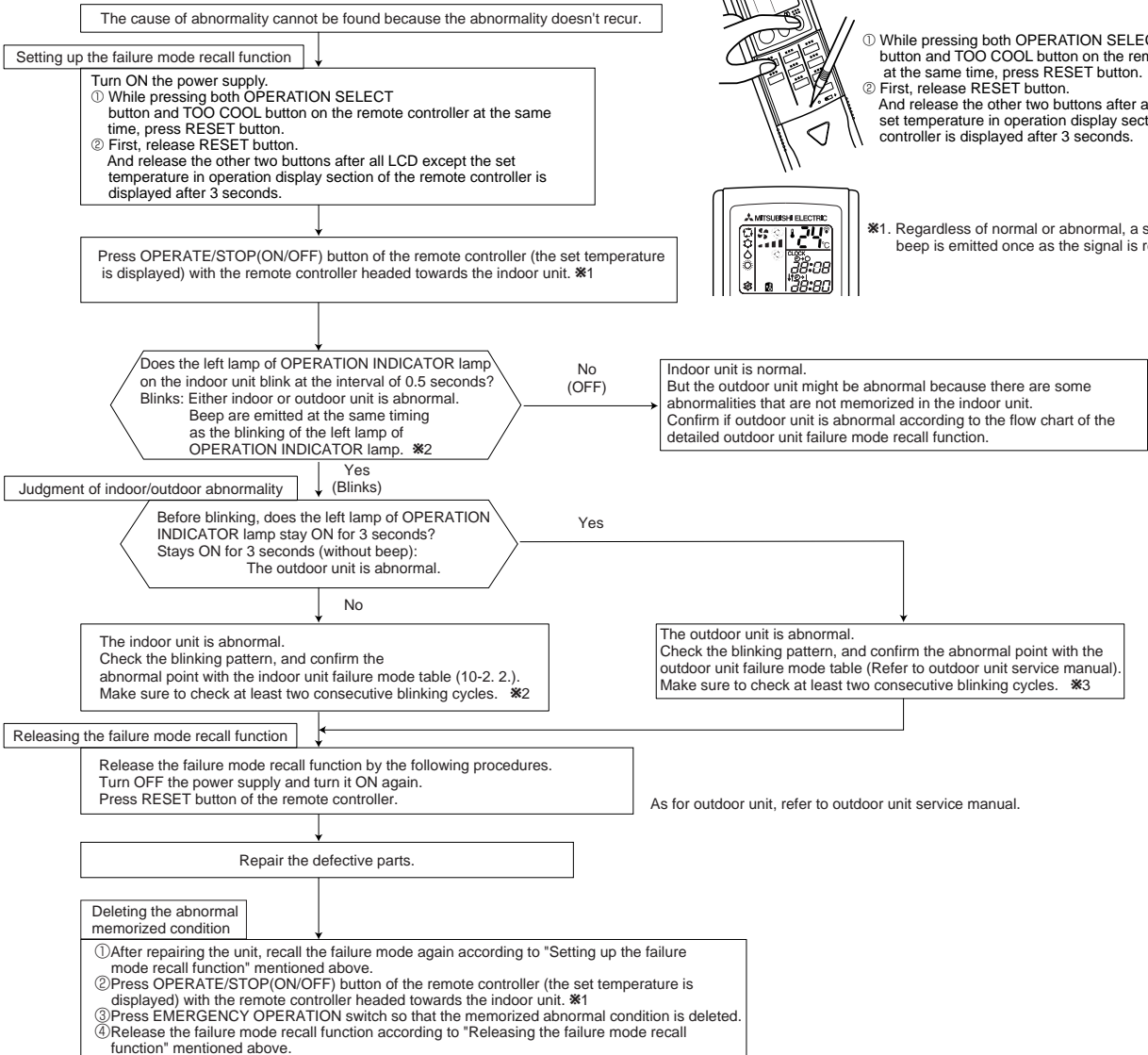

Note1. Make sure to release the failure mode recall function once it's set up, otherwise the unit cannot operate properly.
 2. If the abnormal condition is not deleted from the memory, the last abnormal condition is kept memorized.

※2. Blinking pattern when the indoor unit is abnormal:

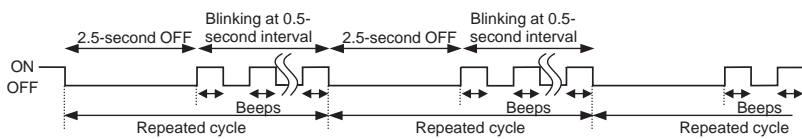

※3. Blinking pattern when the outdoor unit is abnormal:

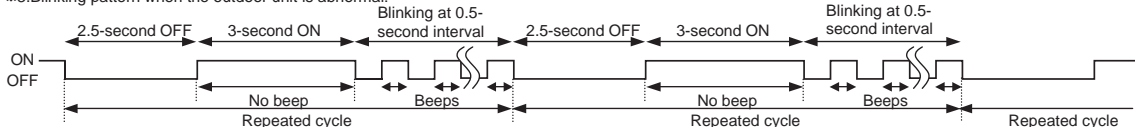

2. Indoor unit failure mode table

NOTE:Blinking patterns of this mode differs from the ones of Troubleshooting check table(10-4.).

Left lamp of OPERATION INDICATOR lamp	Right lamp of OPERATION INDICATOR lamp	Abnormal point (Failure mode)	Check point	Countermeasure
Not lighted	Not lighted	Normal	–	–
1-time flash every 0.5-second	Not lighted	Room temperature thermistor	When the room temperature thermistor short or open circuit is detected every 8 seconds during operation.	Refer to the characteristics of the room temperature thermistor (10-7.).
2-time flash 2.5-second OFF	Not lighted	Indoor coil thermistor (Main 1, 2 and sub)	When the indoor coil thermistor short or open circuit is detected every 8 seconds during operation.	Refer to the characteristic of the main 1,2 indoor coil thermistor and the sub indoor coil thermistor (10-7.).
3-time flash 2.5-second OFF	Not lighted	Serial signal error	When the serial signal from the outdoor unit is not received for a maximum of 6 minutes.	Refer to 10-6.Ⓓ "How to check miswiring and serial signal error".
11-time flash 2.5-second OFF	Not lighted	Indoor fan motor (Upper)	When the rotational frequency feedback signal is not emitted during 12-second the indoor fan operation.	Refer to 10-6 Ⓐ-1 "Check of indoor fan motor (Upper)"
	1-time flash every 0.5-second	Indoor fan motor (Lower)		Refer to 10-6 Ⓐ-2 "Check of indoor fan motor (Lower)"
12-time flash 2.5-second OFF	Not lighted	Indoor control system	When it cannot be read properly data in the nonvolatile memory of the indoor electronic control P.C. board.	Replace the indoor electronic control P.C. board.
13-time flash 2.5-second OFF	Not lighted	Indoor coil thermistor (Main 3)	When the indoor coil thermistor short or open circuit is detected every 8 seconds during operation.	Replace to the characteristic of the main 3 indoor coil thermistor (10-7.).
14-time flash 2.5-second OFF	Not lighted	Damper	When the damper is not located at the designated position.	Refer to 10-6.Ⓔ "Check of damper".

10-3. Instruction of troubleshooting

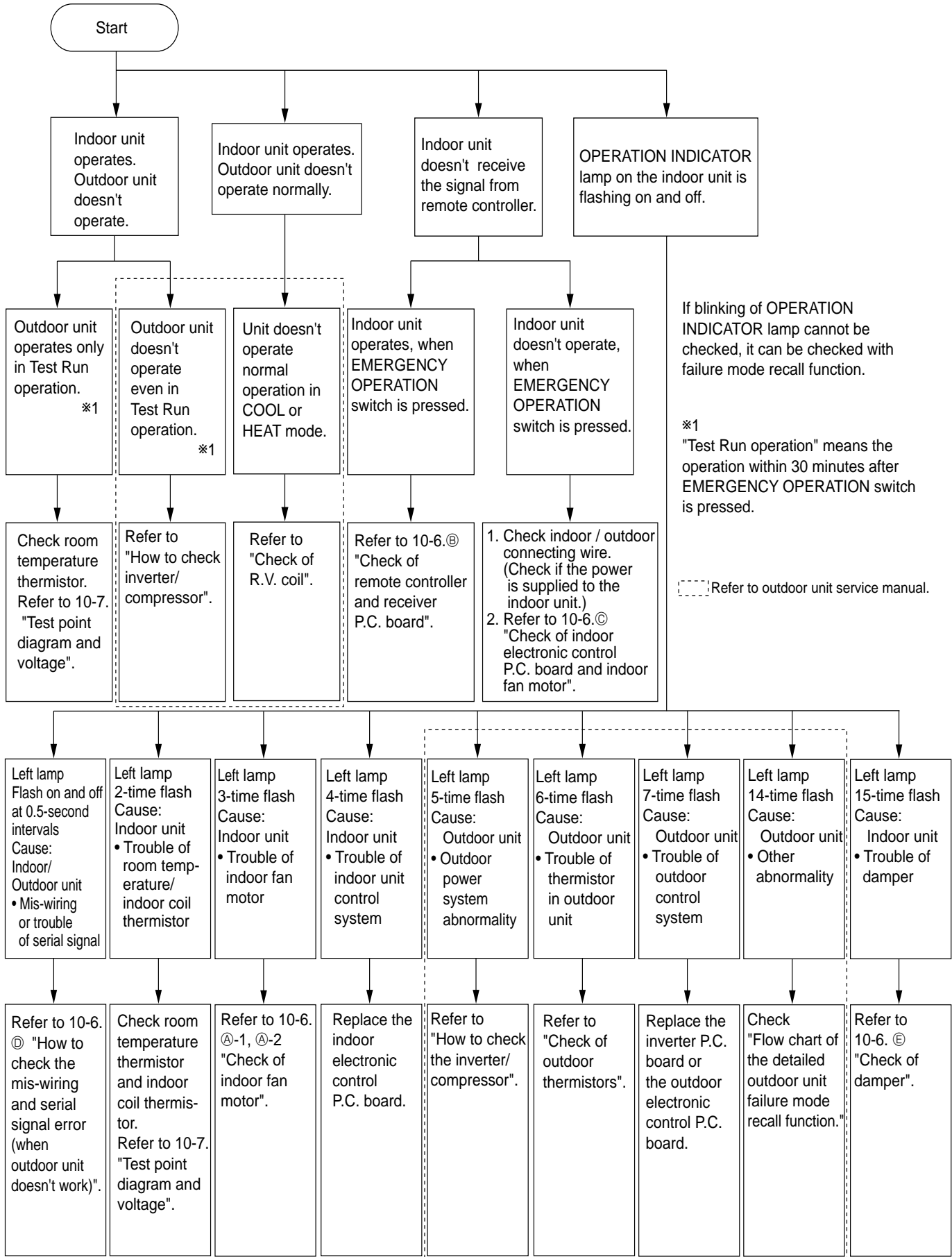

10-4. Troubleshooting check table

OPERATION INDICATOR



Lighted



Blinking









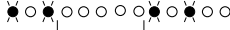
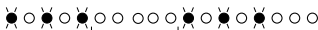
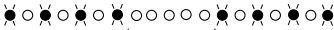

Not lighted

· Flashing of OPERATION INDICATOR lamp (left-hand side lamp) indicates abnormalities.

NOTE : Before taking measures, make sure that the symptom reappears for accurate troubleshooting.

Self check table

No.	Abnormal point	Operation indicator lamp	Symptom	Check point	Countermeasure
1	Mis-Wiring or serial signal	Left lamp flashes. 0.5-second ON  0.5-second OFF	Indoor unit and outdoor unit do not operate.	When the serial signal from the outdoor unit is not received for a maximum of 6 minutes.	• Refer to 10-6.Ⓒ "How to check mis-wiring and serial signal error".
2	Outdoor control system	Left lamp lights up 	Outdoor unit does not operate.	When it cannot properly read data in the nonvolatile memory of the inverter P.C. board or of the outdoor electronic control P.C. board.	• Check the blinking pattern of the LED on the inverter P.C. board or the outdoor electronic control P.C. board.
3	Indoor coil thermistor Room temperature thermistor	Left lamp flashes. 2-time flash  2.5-second OFF	Indoor unit and outdoor unit do not operate.	When the indoor coil or the room temperature thermistor is shorts or opens circuit.	• Refer to the characteristics of indoor coil thermistor, and the room temperature thermistor on 10-7.
4	Indoor fan motor	Left lamp flashes. 3-time flash  2.5-second OFF	Indoor unit and outdoor unit do not operate.	When the rotational frequency feedback signal is not emitted during the indoor fan operation.	• Refer to 10-6.Ⓐ-1, Ⓐ-2 "Check of indoor fan motor".
5	Indoor control system	Left lamp flashes. 4-time flash  2.5-second OFF	Indoor unit and outdoor unit do not operate.	When it cannot properly read data in the nonvolatile memory of the indoor electronic control P.C. board.	• Replace the indoor electronic control P.C. board.
6	Outdoor power system	Left lamp flashes. 5-time flash  2.5-second OFF	Indoor unit and outdoor unit do not operate.	The compressor stops 3 times consecutively for over current protection or start-up failure protection within 1 minute after start-up.	• Refer to "Check of inverter/compressor". Refer to outdoor unit service manual. Check the stop valve.
7	Outdoor thermistors	Left lamp flashes. 6-time flash  2.5-second OFF	Indoor unit and outdoor unit do not operate.	When the outdoor thermistors short or open circuit during the compressor operation.	• Refer to "Check of outdoor thermistor". Refer to outdoor unit service manual.
8	Outdoor control system	Left lamp flashes. 7-time flash  2.5-second OFF	Indoor unit and outdoor unit do not operate.	When it cannot properly read data in the nonvolatile memory of the inverter P.C. board or of the outdoor electronic control P.C. board.	• Replace the inverter P.C. board or the outdoor electronic control P.C. board. Refer to outdoor unit service manual.
9	Other abnormality	Left lamp flashes. 14-time flash  2.5-second OFF	Indoor unit and outdoor unit do not operate.	An abnormality other than above mentioned is detected.	• Confirm the abnormality in detail using the failure mode recall function. Refer to outdoor unit service manual.
10	Indoor damper	Left lamp flashes. 15-time flash  2.5-second OFF	Indoor unit and outdoor unit do not operate.	When the damper is not located at the designated position.	• Refer to 10-6.Ⓔ "Check of damper".

NOTE : When the indoor unit has started operation and the above failures are detected (the first detection after the power ON), the indoor electronic control P.C. board turns OFF the indoor fan motor with OPERATION INDICATOR lamp flashing.

OPERATION INDICATOR

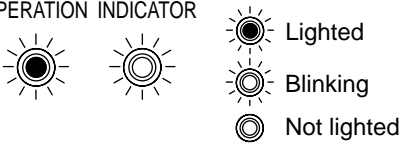

- Flashing of OPERATION INDICATOR lamp (right-hand side lamp) indicates abnormality.
- OPERATION INDICATOR lamp (left-hand side lamp) is lighted.

No.	Abnormal point	Operation indicator lamp	Symptom	Check point	Countermeasure
1	MXZ type Operation mode setting	<p>Right lamp flash</p> <p>2.5-second OFF</p>	Outdoor unit operates but indoor unit does not operate.	When the operation mode of the each indoor unit is differently set to COOL(includes DRY) and HEAT at the same time, the operation mode of the indoor unit that has operated at first has the priority.	<ul style="list-style-type: none"> • Unify the operation mode. Refer to outdoor unit service manual.

NOTE : When the indoor unit has started operation and the above failures are detected (the first detection after the power ON), the indoor electronic control P.C. board turns OFF the indoor fan motor with OPERATION INDICATOR lamp flashing.

10-5. Trouble judgement criteria of main parts

MFZ-KA25VA MFZ-KA35VA MFZ-KA50VA

Part name	Check method and criteria	Figure						
Room temperature thermistor (RT11)	Measure the resistance with a tester. (Part temperature 10°C ~ 30°C)							
Indoor coil thermistor (RT12(MAIN), RT13(SUB))	<table border="1"> <thead> <tr> <th></th> <th>Normal</th> <th>Abnormal</th> </tr> </thead> <tbody> <tr> <td></td> <td>8 kΩ ~ 20 kΩ</td> <td>Open or short-circuit</td> </tr> </tbody> </table>			Normal	Abnormal		8 kΩ ~ 20 kΩ	Open or short-circuit
	Normal	Abnormal						
	8 kΩ ~ 20 kΩ	Open or short-circuit						
Indoor fan motor (Upper) (MF1)	Check 10-6. ㉔-1.							
Indoor fan motor (Lower) (MF2)	Check 10-6. ㉔-2.							
Damper lock motor Right (ML1)	Measure the resistance between the terminals with a tester. (Part temperature 10°C ~ 30°C)							
	<table border="1"> <thead> <tr> <th>Color of the lead wire</th> <th>Normal</th> <th>Abnormal</th> </tr> </thead> <tbody> <tr> <td>BRN-other one</td> <td>235Ω ~ 255Ω</td> <td>Open or short-circuit</td> </tr> </tbody> </table>		Color of the lead wire	Normal	Abnormal	BRN-other one	235Ω ~ 255Ω	Open or short-circuit
Color of the lead wire	Normal		Abnormal					
BRN-other one	235Ω ~ 255Ω		Open or short-circuit					
Damper lock motor Left (ML2)	Measure the resistance between the terminals with a tester. (Part temperature 10°C ~ 30°C)							
	<table border="1"> <thead> <tr> <th>Color of the lead wire</th> <th>Normal</th> <th>Abnormal</th> </tr> </thead> <tbody> <tr> <td>BRN-other one</td> <td>235Ω ~ 255Ω</td> <td>Open or short-circuit</td> </tr> </tbody> </table>		Color of the lead wire	Normal	Abnormal	BRN-other one	235Ω ~ 255Ω	Open or short-circuit
Color of the lead wire	Normal	Abnormal						
BRN-other one	235Ω ~ 255Ω	Open or short-circuit						
Horizontal vane motor(MV1)	Measure the resistance between the terminals with a tester. (Part temperature 10°C ~ 30°C)							
	<table border="1"> <thead> <tr> <th>Color of the lead wire</th> <th>Normal</th> <th>Abnormal</th> </tr> </thead> <tbody> <tr> <td>BRN-other one</td> <td>235Ω ~ 255Ω</td> <td>Open or short-circuit</td> </tr> </tbody> </table>	Color of the lead wire	Normal	Abnormal	BRN-other one	235Ω ~ 255Ω	Open or short-circuit	
Color of the lead wire	Normal	Abnormal						
BRN-other one	235Ω ~ 255Ω	Open or short-circuit						
Horizontal vane motor(MV2)	Measure the resistance between the terminals with a tester. (Part temperature 10°C ~ 30°C)							
	<table border="1"> <thead> <tr> <th>Color of the lead wire</th> <th>Normal</th> <th>Abnormal</th> </tr> </thead> <tbody> <tr> <td>BRN-other one</td> <td>282Ω ~ 306Ω</td> <td>Open or short-circuit</td> </tr> </tbody> </table>	Color of the lead wire	Normal	Abnormal	BRN-other one	282Ω ~ 306Ω	Open or short-circuit	
Color of the lead wire	Normal	Abnormal						
BRN-other one	282Ω ~ 306Ω	Open or short-circuit						

10-6. Troubleshooting flow

When the left lamp of OPERATION INDICATOR lamp flashes 3 times and the right lamp of OPERATION INDICATOR lamp is not lighted.
Indoor fan does not operate.

A-1. Check of indoor fan motor (upper)

The indoor fan motor error has occurred, and the indoor fan doesn't operate.

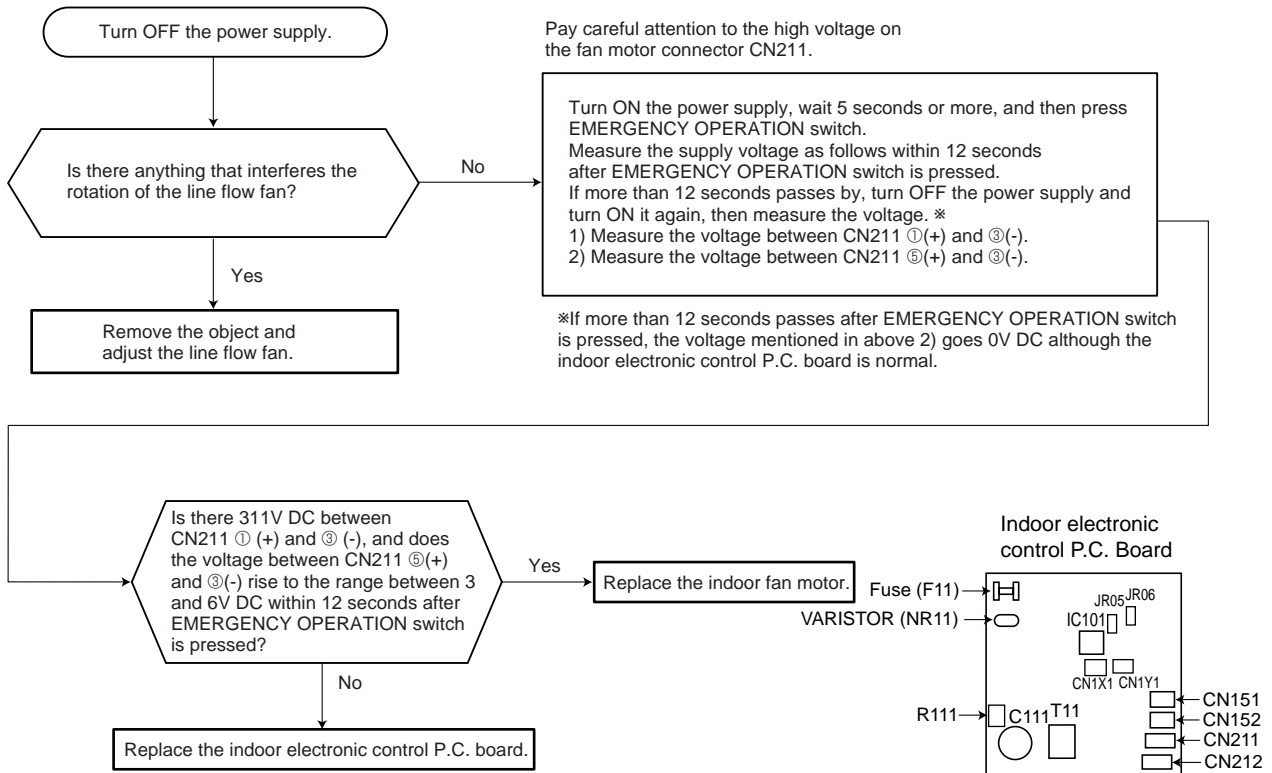

The indoor fan motor error has occurred, and the indoor fan repeats "12-second ON and 30-second OFF" 3 times, and then stops.

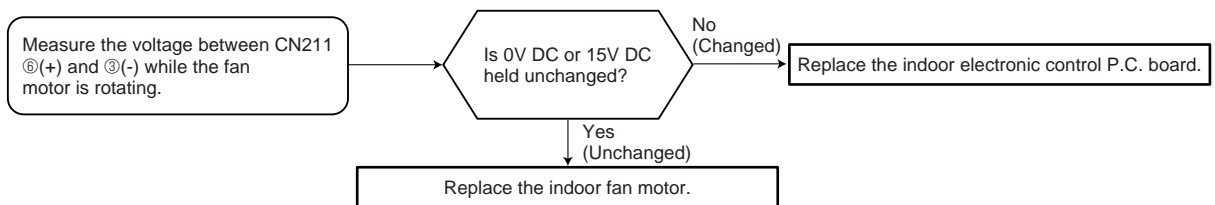

When the left lamp of OPERATION INDICATOR lamp flashes 3 times and the right lamp of OPERATION INDICATOR lamp flashes ON and OFF every 0.5-second.
Indoor fan does not operate.

A-2. Check of indoor fan motor (lower)

The indoor fan motor error has occurred, and the indoor fan doesn't operate.

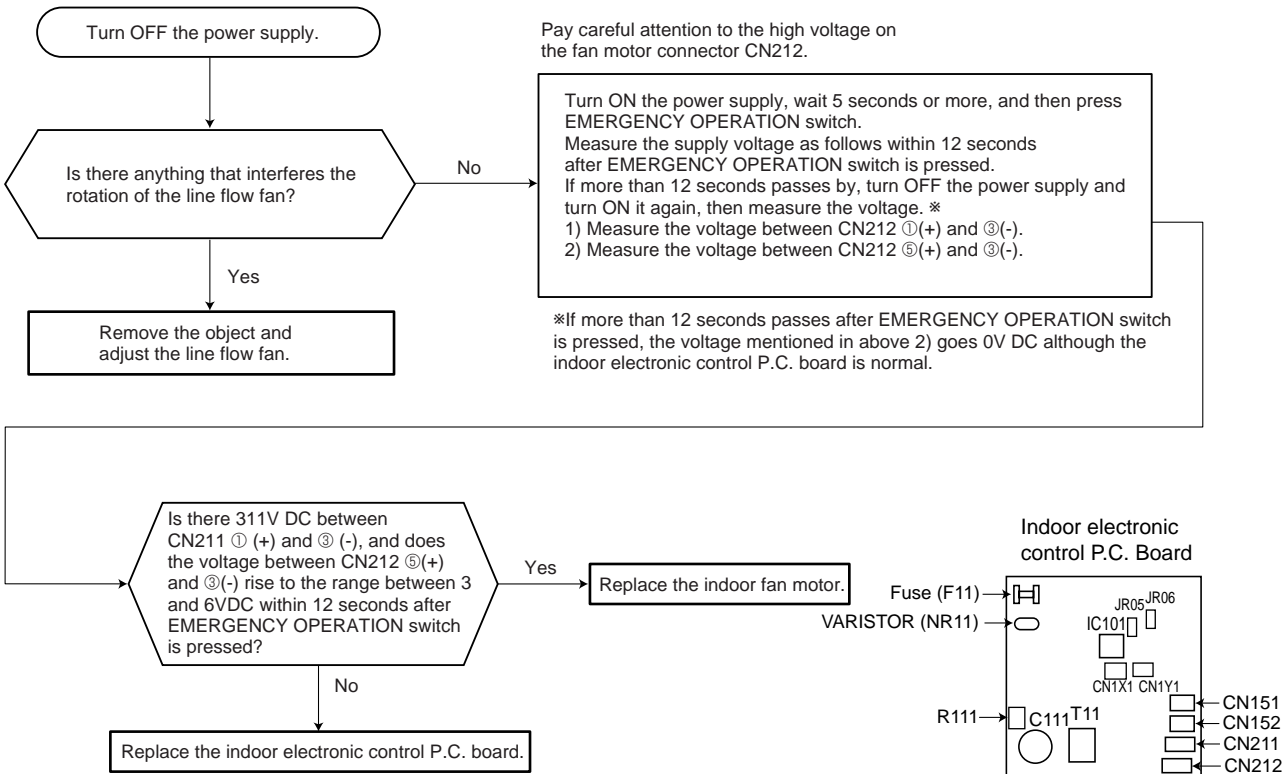

The indoor fan motor error has occurred, and the indoor fan repeats "12-second ON and 30-second OFF" 3 times, and then stops.

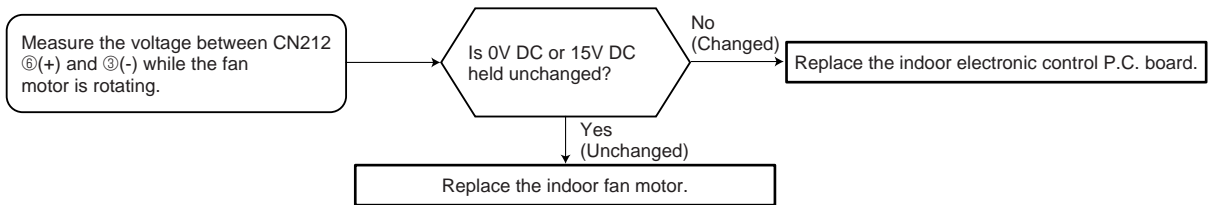

Indoor unit operates by pressing EMERGENCY OPERATION switch, but does not operate with the remote controller.

Ⓑ Check of remote controller and receiver P.C. board

*Check if the remote controller is exclusive for this air conditioner.

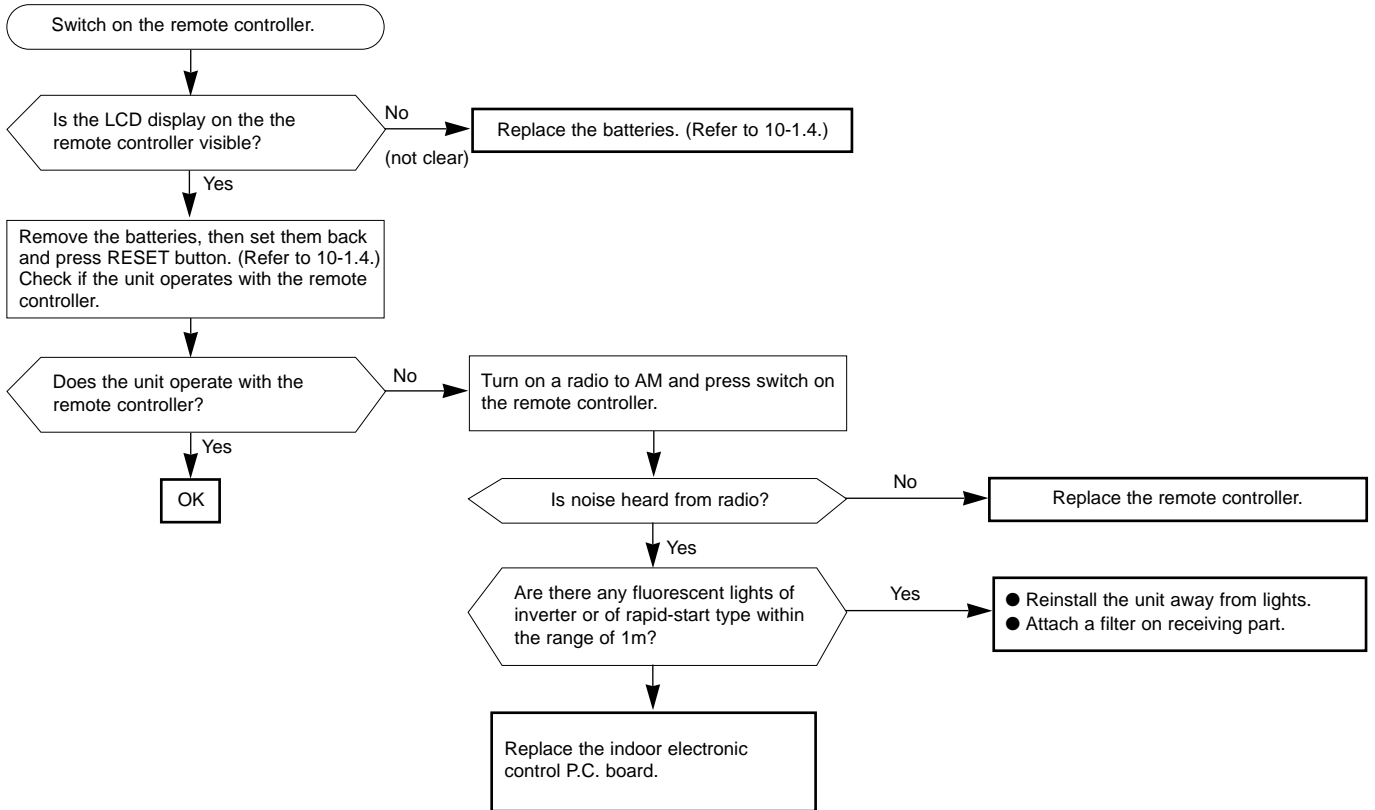

The unit cannot be operated with the remote controller.
 Also, OPERATION INDICATOR lamp does not light up by pressing EMERGENCY OPERATION switch.

© Check of indoor electronic control P.C. board and indoor fan motor

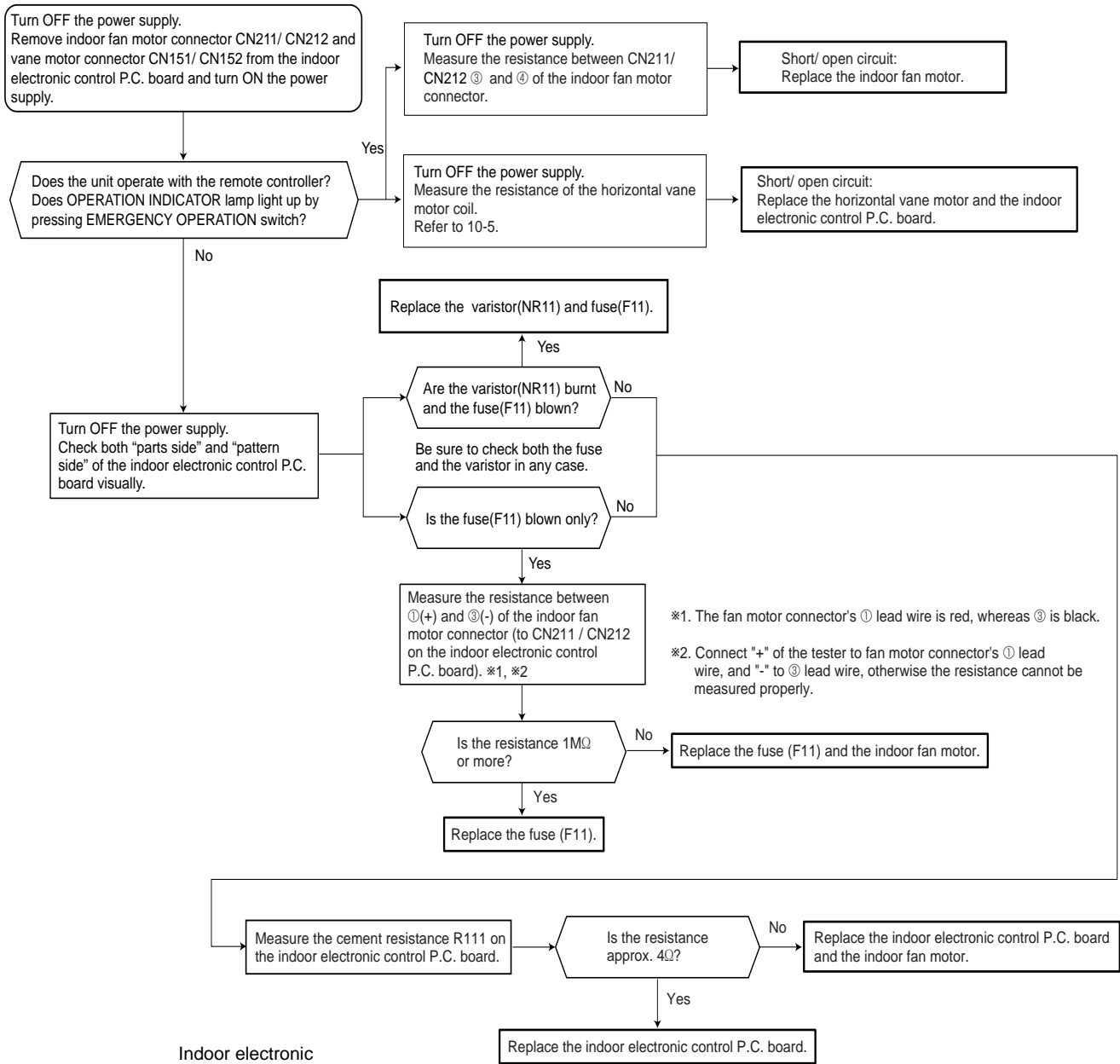

Indoor electronic control P.C. Board

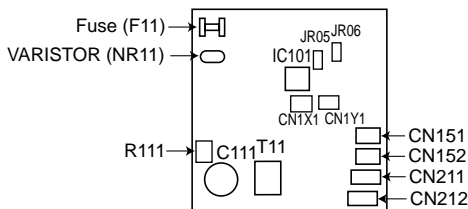

When the left lamp of OPERATION INDICATOR lamp flashes ON and OFF in every 0.5-second.
Outdoor unit does not operate.

D How to check mis-wiring and serial signal error

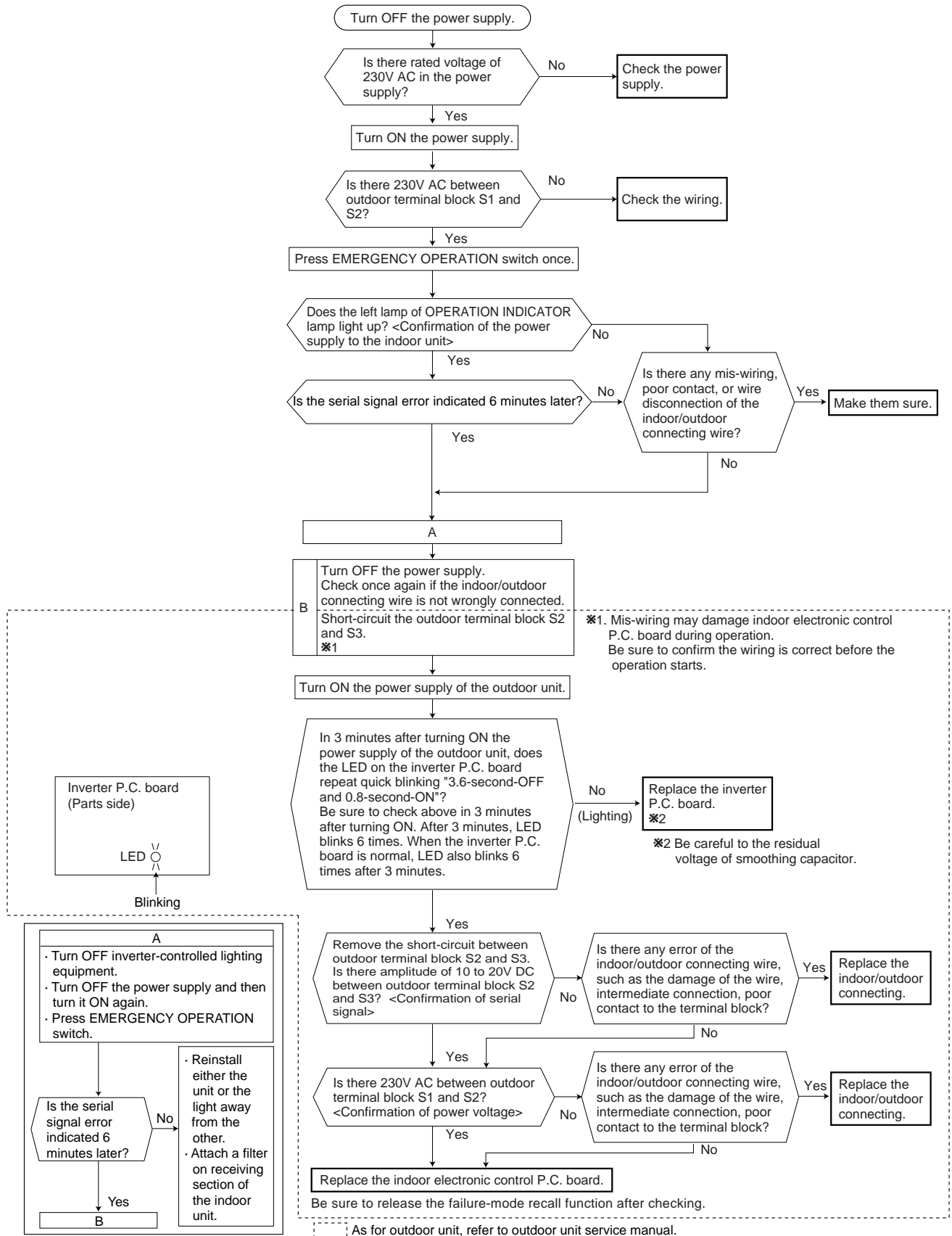

**When the left lamp of OPERATION INDICATOR lamp flashes 15-time.
Indoor unit and outdoor unit do not operate.**

E Check of damper

After performing the check, make sure to release the failure mode recall function.

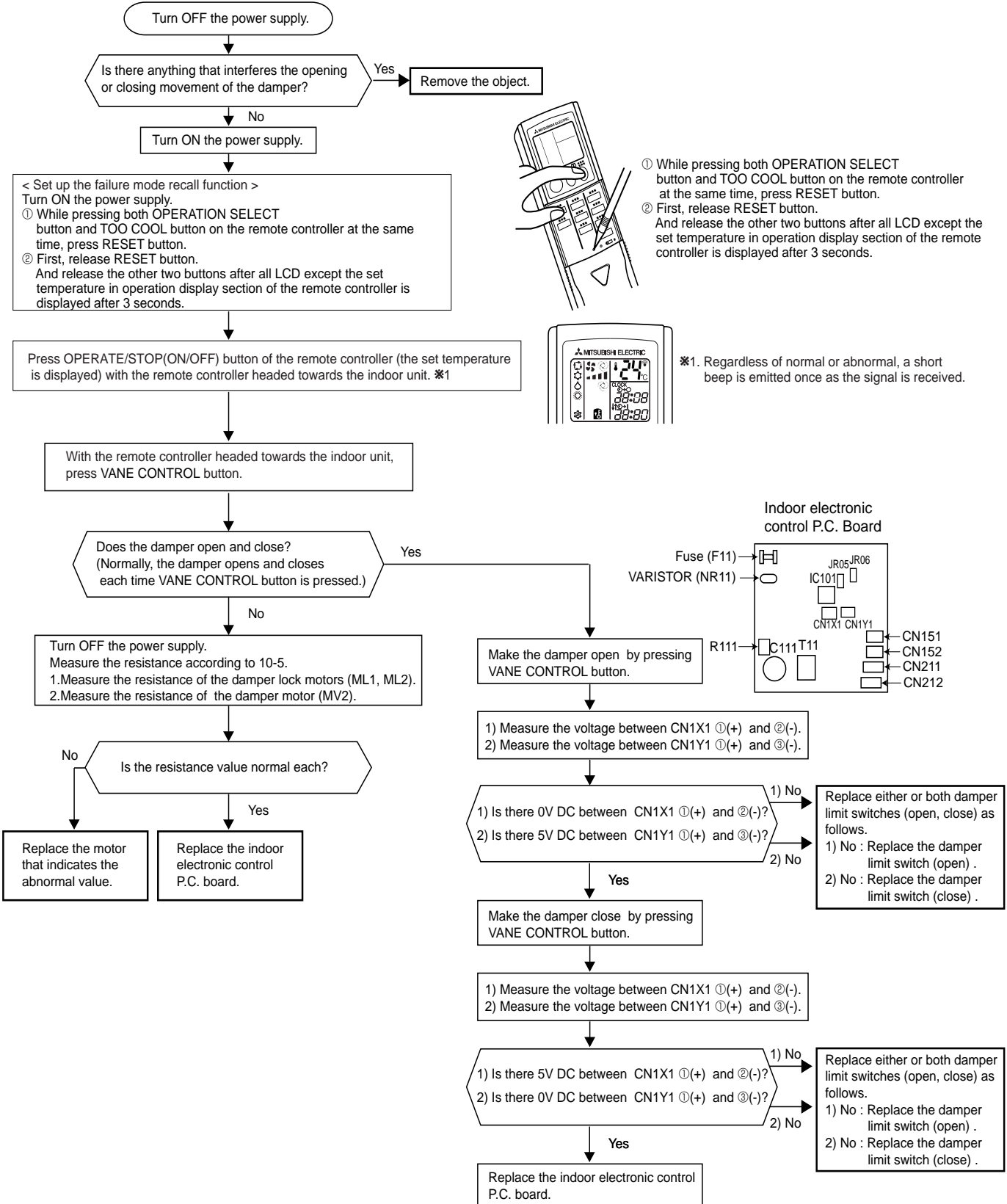

F Electromagnetic noise enters into TV sets or radios

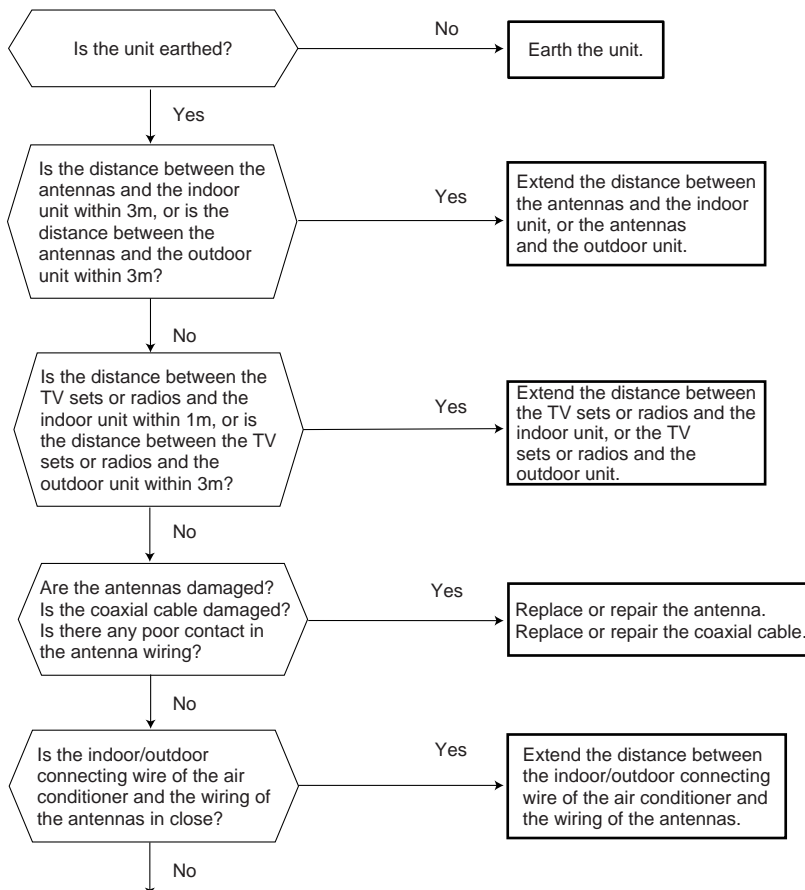

Even if all of the above conditions is fulfilled, the electromagnetic noise may enter, depending on the electric field strength or the installation condition (combination of specific conditions such as antennas or wiring).
 Check the followings before asking for service.

- 1.Devices affected by the electromagnetic noise
 TV sets, radios (FM/AM broadcast, shortwave)
- 2.Channel, frequency, broadcast station affected by the electromagnetic noise
- 3.Channel, frequency, broadcast station unaffected by the electromagnetic noise
- 4.Layout of ;
 indoor/outdoor unit of the air conditioner, indoor/outdoor wiring, grounding wire, antennas, wiring from antennas, receiver
- 5.Electric field intensity of the broadcast station affected by the electromagnetic noise
- 6.Presence or absence of amplifier such as booster
- 7.Operation condition of air conditioner when the electromagnetic noise enters in.
 - 1)Turn OFF the power supply once, and then turn ON the power supply. In this situation check for the electromagnetic noise.
 - 2)Within 3 minutes after turning ON the power supply, press OPERATE/STOP (ON/OFF) button on the remote controller for power ON, and check for the electromagnetic noise.
 - 3)After a short time (3 minutes later after turning ON), the outdoor unit starts running. During operation, check for the electromagnetic noise.
 - 4)Press OPERATE/STOP (ON/OFF) button on the remote controller for power OFF, when the outdoor unit stops but the indoor/outdoor communication still runs on. In this situation check for the electromagnetic noise.

After checking the above, consult the service representative.

10-7. Test point diagram and voltage

MFZ-KA25VA MFZ-KA35VA MFZ-KA50VA

Indoor electronic control P.C. board

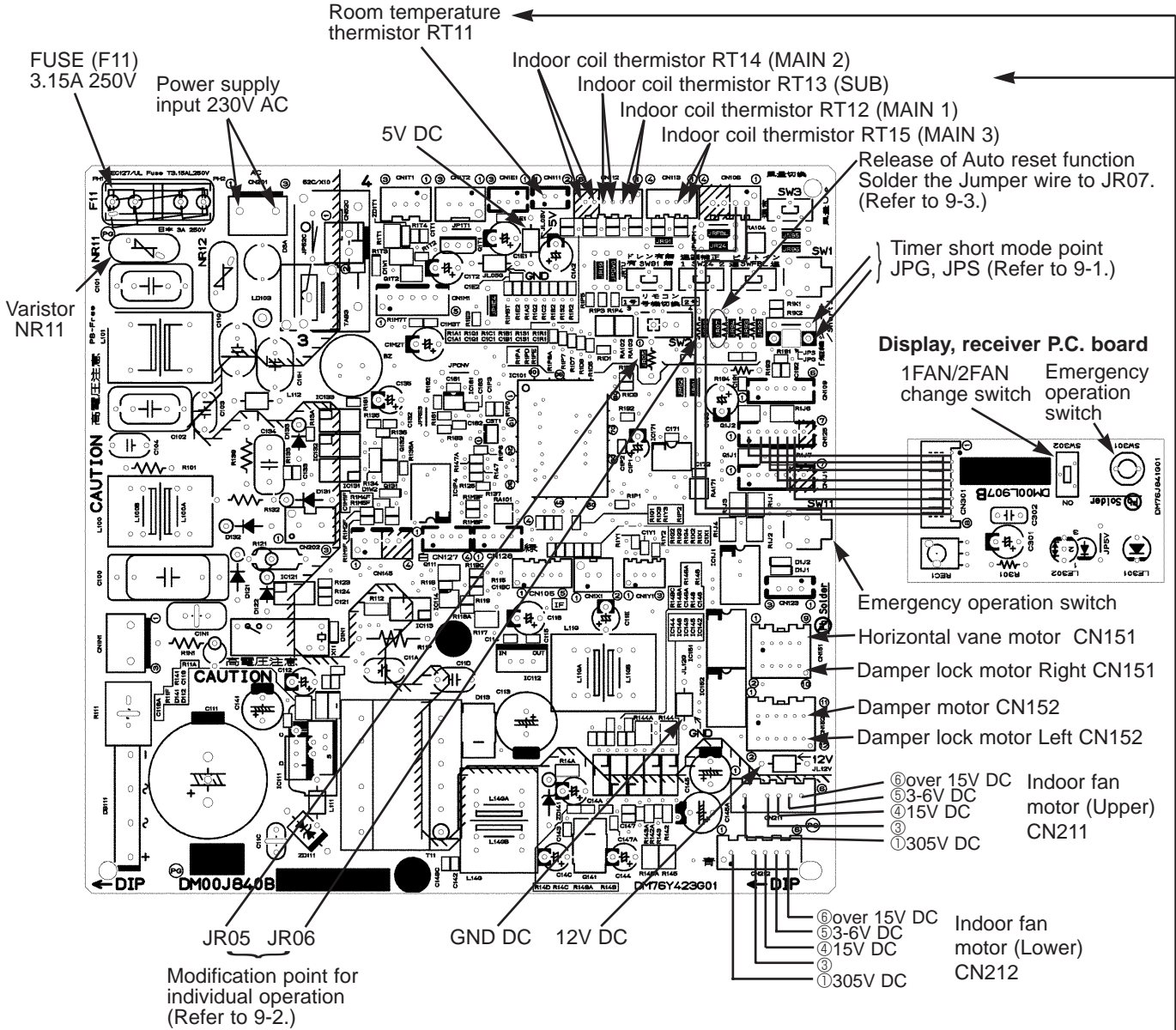

Indoor coil thermistor [RT12,RT14,RT15 (MAIN), RT13 (SUB)]
Room temperature thermistor (RT11)

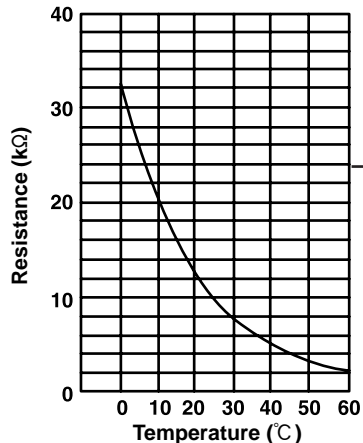

<"Terminal with locking mechanism" Detaching points>

The terminal which has the locking mechanism can be detached as shown below.
There are two types (Refer to (1) and (2)) of the terminal with locking mechanism.
The terminal without locking mechanism can be detached by pulling it out.
Check the shape of the terminal before detaching.

(1) Slide the sleeve and check if there is a locking lever or not.

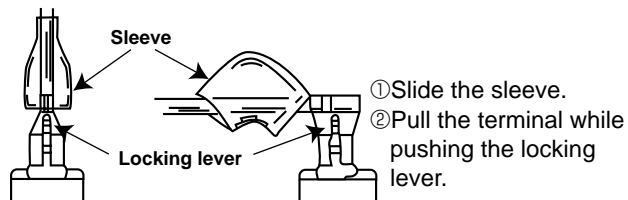

(2) The terminal with this connector has the locking mechanism.

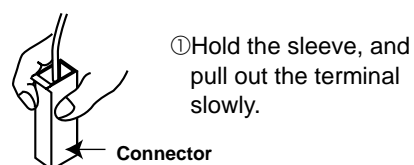

MFZ-KA25VA MFZ-KA35VA MFZ-KA50VA INDOOR UNIT

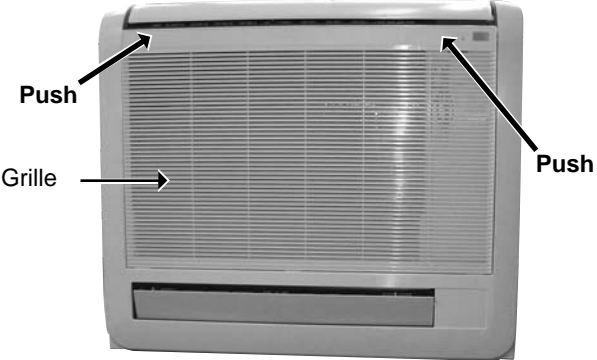
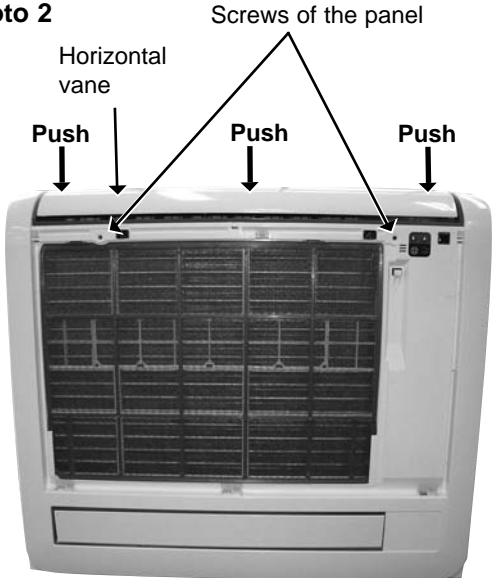
OPERATING PROCEDURE	PHOTOS
<p>1. Removing the panel</p> <p>(1) Push both sides of the upper part of the front grille and pull the front grille open, and then remove the front grille from the panel. (See Photo 1.)</p> <p>(2) Remove the screws of the panel. (See Photo 2.)</p> <p>(3) Open the horizontal vane and push the left, right and middle of the upper part of the panel, and pull the panel toward you. (See Photo 2.)</p> <p>(4) Lift up the panel and remove it from the box.</p>	<p>Photo 1</p>  <p>Photo 2</p> 

OPERATING PROCEDURE

2. Removing the electronic control P.C. board and the display receiver P.C. board

- (1) Remove the panel. (Refer to 1.)
- (2) Remove the screw of the electrical cover, and then the electrical cover. (See Photo 3.)
- (3) Remove the screw of the ground wires under the electrical box, and then the ground wires. (See Photo 4.)
- (4) Remove the screw of the ground wires connected to the indoor fan motor (lower), and then the ground wires. (See Photo 4.)
- (5) Remove the screw of the ground wires connected to the indoor heat exchanger, and then the ground wires. (See Photo 4.)
- (6) Unhook the lamp cover from the catch. (See Photo 4.)
- (7) Open the lamp cover and pull out the display receiver P.C. board.
- (8) Remove the screw of the ground wires connected to the electronic control P.C. board, and then the ground wires. (See Photo 4.)
- (9) Pull the electronic control P.C. board slightly toward you from the electrical box, and disconnect all the connectors on the electronic control P.C. board.
- (10) Pull out the electronic control P.C. board from the electrical box.

3. Removing the electrical box

- (1) Remove the panel. (Refer to 1.)
- (2) Remove the electrical cover. (Refer to 2.)
- (3) Remove the ground wires from the electrical box. (Refer to 2.)
- (4) Remove the ground wires connected to the indoor fan motor and the ones connected to the indoor heat exchanger. (Refer to 2.)
- (5) Remove the screw of the electrical box. (See Photo 4.)
- (6) Disconnect the following connectors on the electronic control P.C. board. (See Photo 5.)
 - Fan motor connectors < CN211, CN212 >
 - Horizontal vane motor connector < CN151 >
 - Damper motor connector < CN152 >
 - Display receiver P.C. board connectors < CN106, CN125 >
 - Indoor coil thermistor connectors < CN112, CN113 >
 - Room temperature thermistor connector < CN111 >
 - Damper limit switch connectors < CN1X1, CN1Y1 >
- (7) Unhook the electrical box from the upper catch and pull out the electrical box from the box.

PHOTOS

Photo 3

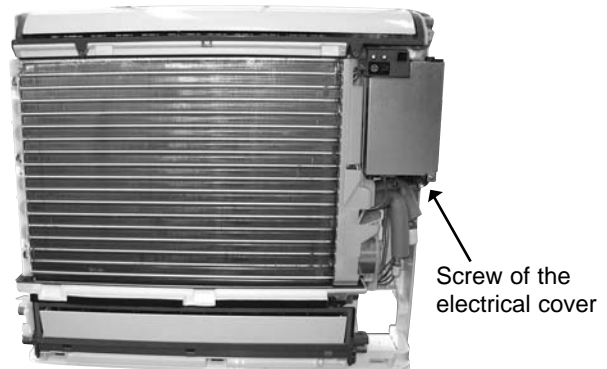

Photo 4

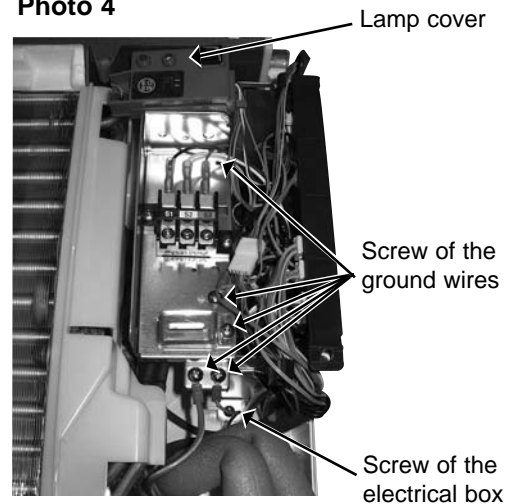
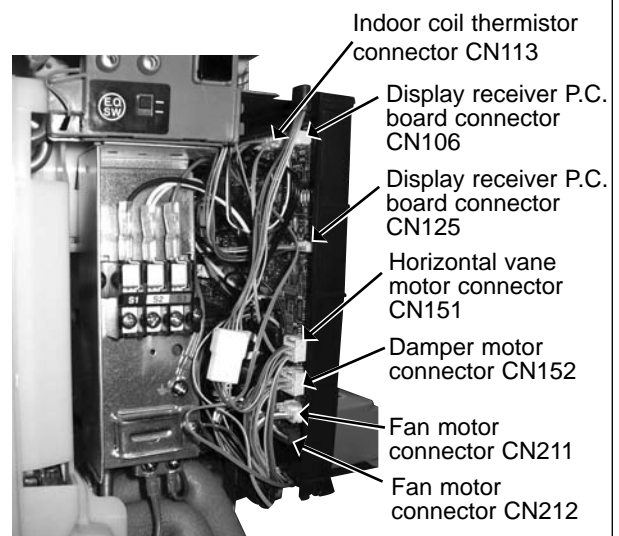

Photo 5





OPERATING PROCEDURE

4. Removing the horizontal vane motor unit

- (1) Remove the panel. (Refer to 1.)
- (2) Remove the screws of the horizontal vane motor unit and pull out the horizontal vane motor unit. (See Photo 6.)
- (3) Disconnect the connector from the horizontal vane motor unit.

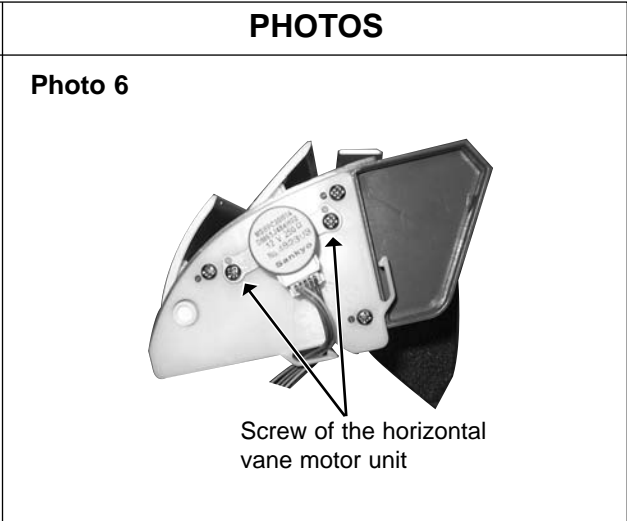

5. Removing the indoor fan motor (upper)

- (1) Remove the panel. (Refer to 1.)
- (2) Remove the electrical box. (Refer to 3.)
- (3) Remove the nozzle (upper). (See Photo 7.)
- (4) Unhook the water cover from the catches and remove the water cover. (See Photo 7.)
- (5) Removing the screw of the motor band, and then the motor band. (See Photo 8.)
- (6) Remove the line flow fan and the indoor fan motor (upper) from the box.

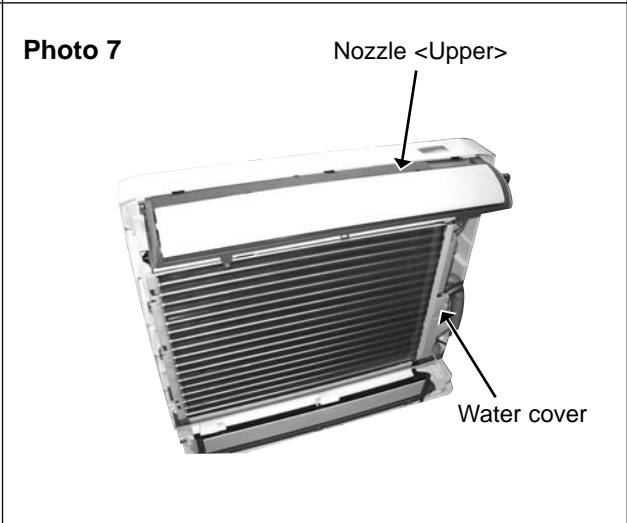

OPERATING PROCEDURE

6. Removing the damper lock motor, the damper motor and the damper limit switch

- (1) Remove the panel. (Refer to 1.)
- (2) Remove the screws of the nozzle assembly (lower). (See Photo 9.)
- (3) Remove the drain hose from the nozzle assembly (lower) and pull out the nozzle assembly (lower) toward you.
- (4) Remove the tape fixing the lead wires of the damper motor and the damper lock motor from the nozzle assembly <lower>. (See Photo 10.)
- (5) Remove the screws of the damper lock motor. (See Photo 11 and 12.)
- (6) Lift the nozzle slightly and remove the lock shaft from within the nozzle and remove the damper lock motors (ML1, ML2).
- (7) Remove the screws of the damper motor support, and then the damper motor support.
- (8) Remove the screws of the damper motor, and then the damper motor from the damper motor support.
- (9) Disconnect the connector from the damper motor.
- (10) Remove the damper limit switches (LS1, LS2).

7. Removing the indoor fan motor (lower)

- (1) Remove the panel. (Refer to 1.)
- (2) Remove the nozzle assembly (lower) and the drain hose. (Refer to 6.)
- (3) Remove the screw of the ground wire of the indoor fan motor (lower), and then the ground wire. (See Photo 13.)
- (4) Remove the screw of the motor band, and then the motor band. (See Photo 13.)
- (5) Remove the line flow fan and the indoor fan motor (lower) from the box.

Photo 13

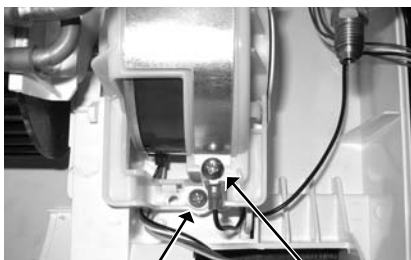

Screw of the motor band
Screw of the ground wire

PHOTOS

Photo 9



Screw of the nozzle

Screw of the nozzle

Drain hose

Photo 10

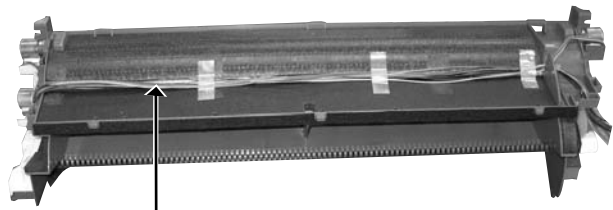

Lead wires of the damper motor and the damper lock motor

Photo 11

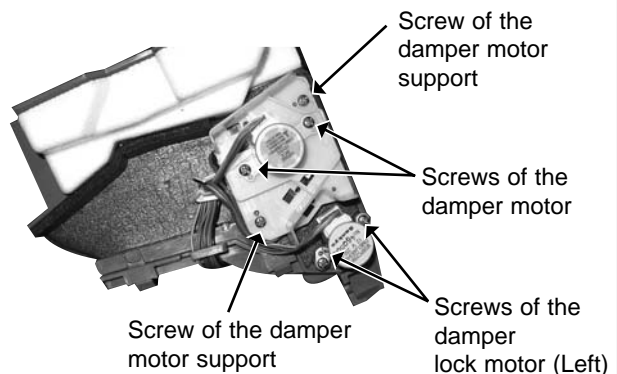

Screw of the damper motor support

Screws of the damper motor

Screw of the damper motor support

Screws of the damper lock motor (Left)

Photo 12

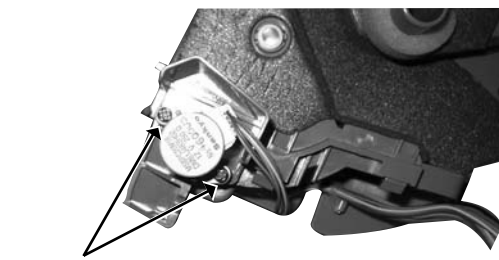

Screws of the damper lock motor (Right)

12

PARTS LIST (non-RoHS compliant)

MFZ-KA25VA

MFZ-KA35VA

MFZ-KA50VA

12-1. INDOOR UNIT STRUCTURAL PARTS

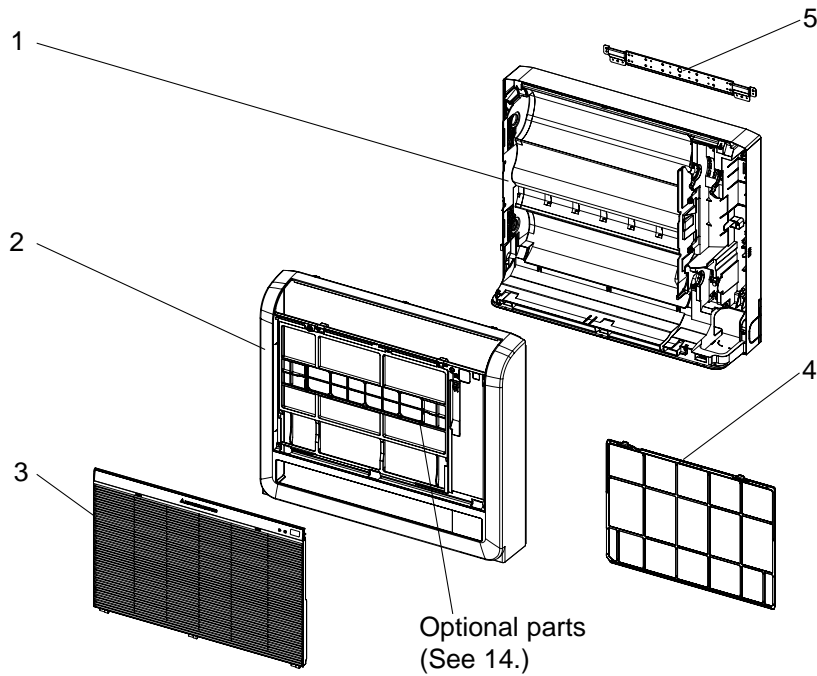

12-2. ACCESSORY AND REMOTE CONTROLLER



12-1. INDOOR UNIT STRUCTURAL PARTS

No.	Part No.	Part name	Symbol in Wiring Diagram	Q'ty/unit			Remarks
				MFZ-KA25VA -[E1]	MFZ-KA35VA -[E1]	MFZ-KA50VA -[E1]	
1	M21 E0W 234	BOX ASSEMBLY		1	1	1	
2	T2W A4T 000	PANEL ASSEMBLY		1	1	1	
3	T2W A4T 010	FRONT GRILLE		1	1	1	
4	T2W A4T 100	CATECHIN AIR FILTER		1	1	1	
5	T2W A4T 233	BACK PLATE		1	1	1	

12-2. ACCESSORY AND REMOTE CONTROLLER

Part number that is circled is not shown in the illustration.

6	T2W A4T 426	REMOTE CONTROLLER		1	1	1	KM05G
⑦	M21 HL5 256	FELT TAPE		1	1	1	

PARTS LIST (non-RoHS compliant)

MFZ-KA25VA
MFZ-KA35VA
MFZ-KA50VA

12-3. INDOOR UNIT ELECTRICAL PARTS AND FUNCTIONAL PARTS

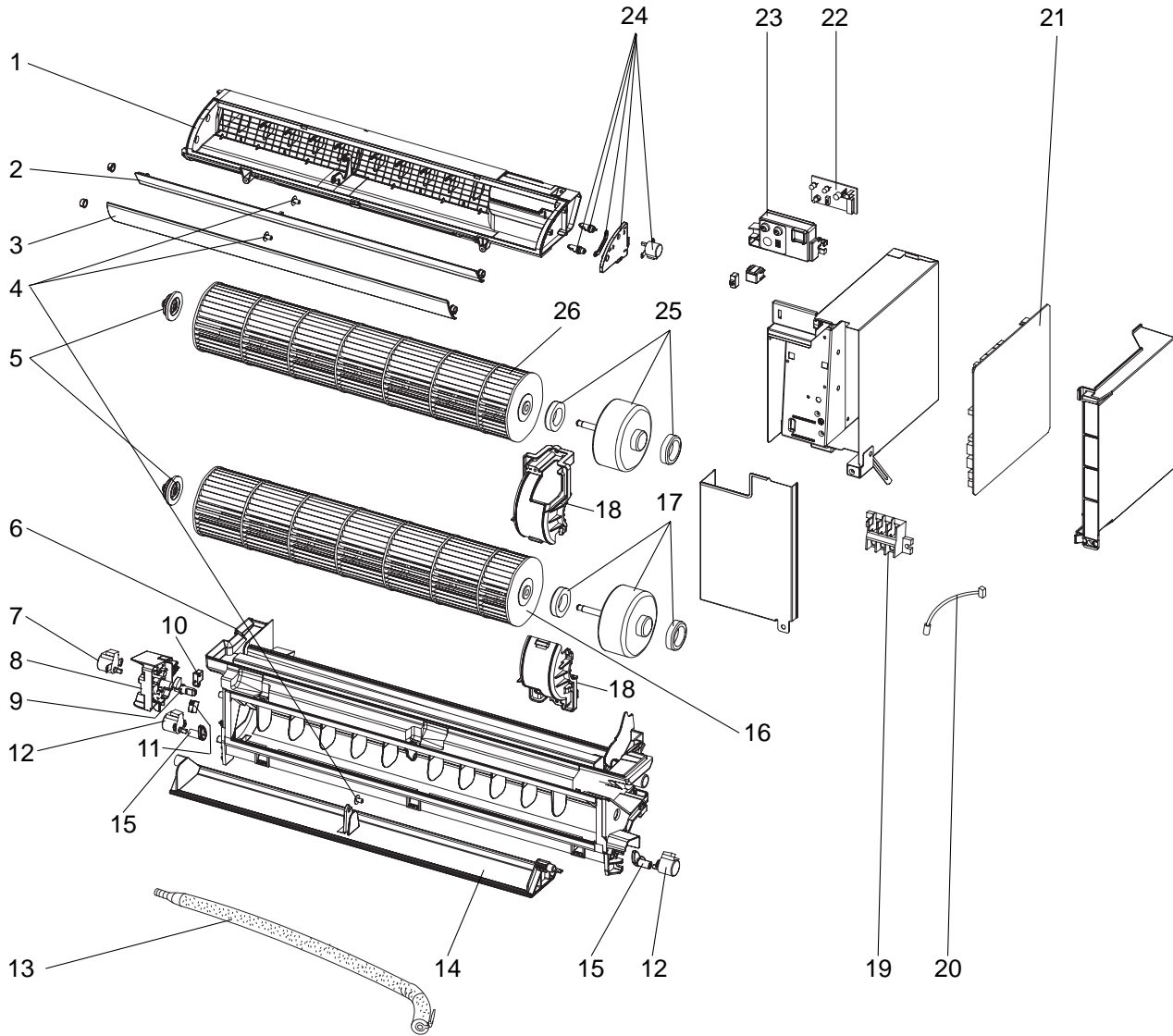

PARTS LIST (non-RoHS compliant)

12-3. INDOOR UNIT ELECTRICAL PARTS AND FUNCTIONAL PARTS

Part numbers that are circled are not shown in the illustration.

No.	Part No.	Part name	Symbol in Wiring Diagram	Q'ty/unit			Remarks
				MFZ-KA25VA - [E1]	MFZ-KA35VA - [E1]	MFZ-KA50VA - [E1]	
1	M21 E0W 235	NOZZLE ASSEMBLY (UPPER)		1	1	1	
2	T2W A6T 040	HORIZONTAL VANE (BACK)		1	1	1	
3	T2W A4T 040	HORIZONTAL VANE (FRONT)		1	1	1	
4	T2W A4T 079	VANE SLEEVE		3	3	3	
5	M21 E0W 504	BEARING ASSEMBLY		2	2	2	
6	M21 E2W 235	NOZZLE ASSEMBLY (LOWER)		1	1	1	
7	T2W A6T 306	DAMPER MOTOR	MV2	1	1	1	UP & DOWN
8	T2W A4T 506	VANE MOTOR SUPPORT		1	1	1	
9	T2W A6T 049	SM SHAFT		1	1	1	
10	T2W A6T 047	DAMPER LIMIT SWITCH (CLOSE)	LS2	1	1	1	
11	T2W A4T 047	DAMPER LIMIT SWITCH (OPEN)	LS1	1	1	1	
12	M21 WJ7 306	DAMPER LOCK MOTOR	ML1,2	2	2	2	RIGHT & LEFT
13	M21 W60 703	DRAIN HOSE		1	1	1	
14	T2W A6T 041	DAMPER		1	1	1	
15	T2W A4T 049	LOCK SHAFT		2	2	2	
16	T2W A5T 309	LINE FLOW FAN (LOWER)		1	1	1	
17	T2W A4T 301	INDOOR FAN MOTOR ASSEMBLY (LOWER)*	MF2	1	1	1	RC0J30- <input type="checkbox"/> <input type="checkbox"/>
18	T2W A4T 515	MOTOR BAND		2	2	2	
19	T2W YH1 376	TERMINAL BLOCK	TB	1	1	1	
20	M21 H81 307	ROOM TEMPERATURE THERMISTOR	RT11	1	1	1	
21	T2W A4T 450	ELECTRONIC CONTROL P.C. BOARD		1			AUTO RESTART
	T2W A5T 450	ELECTRONIC CONTROL P.C. BOARD			1		AUTO RESTART
	T2W A6T 450	ELECTRONIC CONTROL P.C. BOARD				1	AUTO RESTART
22	T2W A4T 328	DISPLAY RECEIVER SWITCH P.C. BOARD		1	1	1	
23	M21 E0W 043	LAMP COVER		1	1	1	
24	T2W A4T 306	HORIZONTAL VANE MOTOR UNIT	MV1	1	1	1	UP & DOWN
25	T2W A4T 300	INDOOR FAN MOTOR ASSEMBLY (UPPER)*	MF1	1	1	1	RC0J30- <input type="checkbox"/> <input type="checkbox"/>
26	T2W A4T 309	LINE FLOW FAN (UPPER)		1	1	1	
(27)	T2W A4T 382	FUSE	F11	1	1	1	T3.15AL250V
(28)	T2W A4T 384	VARISTOR	NR11	1	1	1	

* Including fan motor rubber mount (2PCS/SET)

PARTS LIST (non-RoHS compliant)

MFZ-KA25VA

MFZ-KA35VA

MFZ-KA50VA

12-4. INDOOR UNIT HEAT EXCHANGER

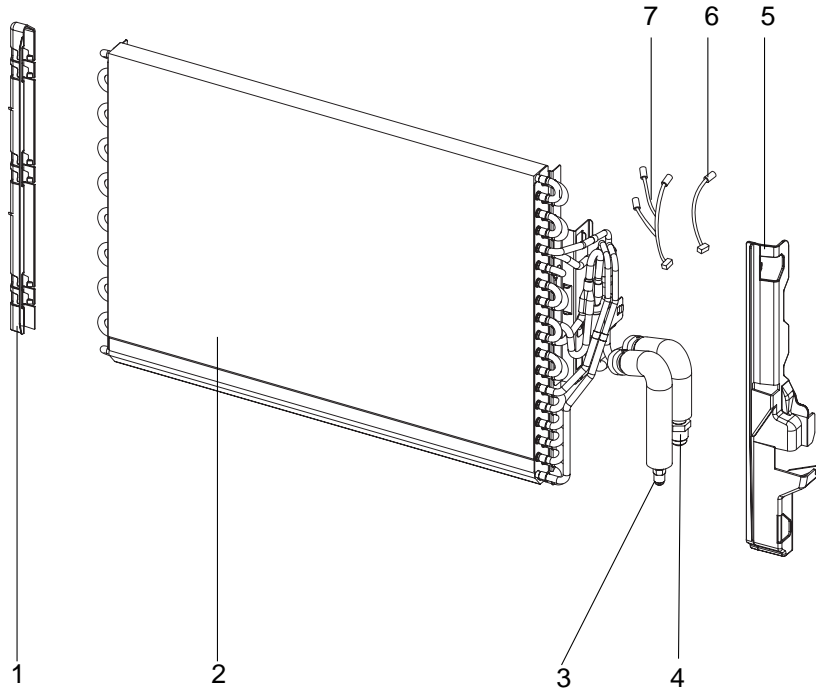

12-4. INDOOR UNIT HEAT EXCHANGER

No.	Part No.	Part name	Symbol in Wiring Diagram	Q'ty/unit			Remarks
				MFZ-KA25VA - [E1]	MFZ-KA35VA - [E1]	MFZ-KA50VA - [E1]	
1	T2W A4T 638	HAIR PIN COVER		1	1	1	
2	M21 E0W 620	INDOOR HEAT EXCHANGER		1	1		
	M21 E8W 620	INDOOR HEAT EXCHANGER				1	
3	M21 VL4 664	UNION (LIQ)		1	1	1	φ 6.35
4	M21 NJ9 663	UNION (GAS)		1	1		φ 9.52
	M21 VL4 663	UNION (GAS)				1	φ 12.7
5	T2W A4T 791	WATER COVER		1	1	1	
6	T2W A5T 308	INDOOR COIL THERMISTOR	RT13	1	1	1	
7	T2W A4T 308	INDOOR COIL THERMISTOR SET	RT12,14,15	1	1	1	3PCS/SET

13

RoHS PARTS LIST (RoHS compliant)

MFZ-KA25VA

MFZ-KA35VA

MFZ-KA50VA

13-1. INDOOR UNIT STRUCTURAL PARTS

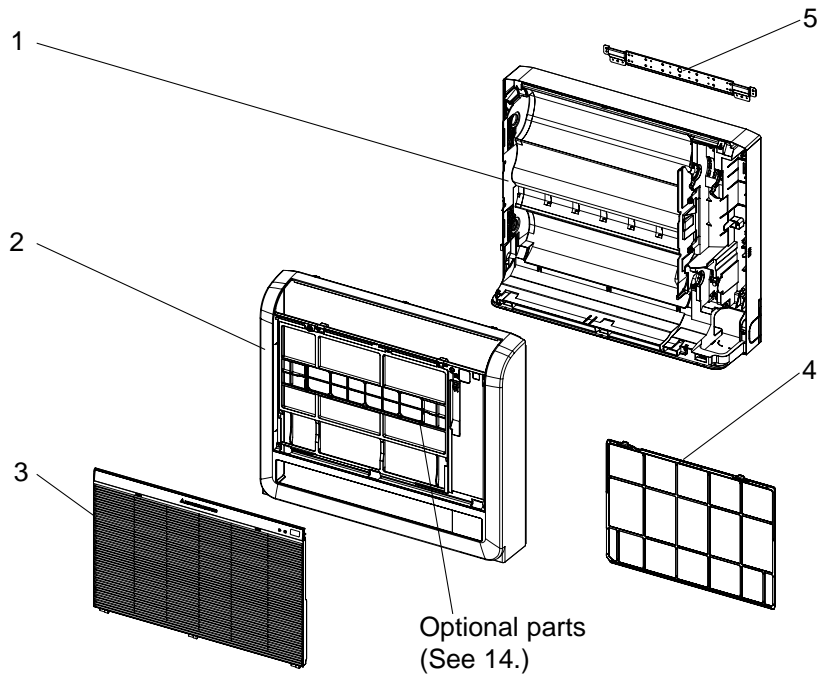

13-2. ACCESSORY AND REMOTE CONTROLLER



13-1. INDOOR UNIT STRUCTURAL PARTS

No.	RoHS	Part No.	Part name	Symbol in Wiring Diagram	Q'ty/unit						Remarks
					MFZ-KA						
					25VA -		35VA -		50VA -		
1	G	T2W L3V 234	BOX ASSEMBLY		1	1	1	1	1	1	
2	G	T2W L3V 000	PANEL ASSEMBLY		1	1	1	1	1	1	
3	G	T2W L3V 010	FRONT GRILLE		1	1	1	1	1	1	
4	G	M21 L3V 100	CATECHIN AIR FILTER		1	1	1	1	1	1	
5	G	T2W L3V 233	BACK PLATE		1	1	1	1	1	1	

13-2. ACCESSORY AND REMOTE CONTROLLER

Part number that is circled is not shown in the illustration.

6	G	T2W A4T 426	REMOTE CONTROLLER		1	1	1	1	1	1	KM05G
⑦	G	M21 L3V 256	FELT TAPE		1	1	1	1	1	1	

RoHS PARTS LIST (RoHS compliant)

MFZ-KA25VA
MFZ-KA35VA
MFZ-KA50VA

13-3. INDOOR UNIT ELECTRICAL PARTS AND FUNCTIONAL PARTS

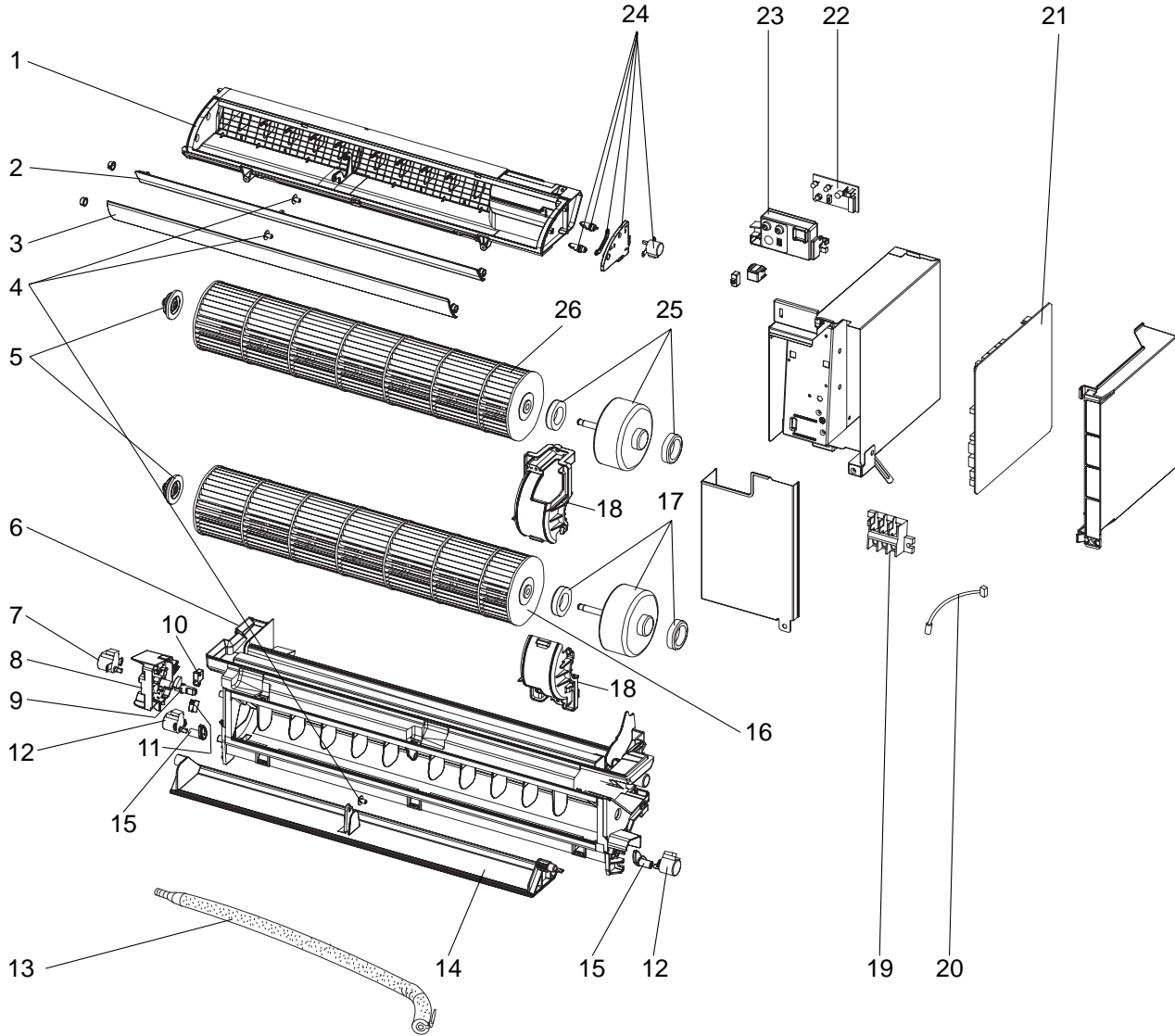

RoHS PARTS LIST (RoHS compliant)

13-3. INDOOR UNIT ELECTRICAL PARTS AND FUNCTIONAL PARTS

Part numbers that are circled are not shown in the illustration.

No.	RoHS	Part No.	Part name	Symbol in Wiring Diagram	Q'ty/unit						Remarks
					MFZ-KA						
					25VA -		35VA -		50VA -		
E1	E2	E1	E2	E1	E2						
1	G	M21 L3V 235	NOZZLE ASSEMBLY (UPPER)		1	1	1	1	1	1	
2	G	M21 L4V 040	HORIZONTAL VANE (BACK)		1	1	1	1	1	1	
3	G	M21 L3V 040	HORIZONTAL VANE (FRONT)		1	1	1	1	1	1	
4	G	M21 L3V 071	VANE SLEEVE		3	3	3	3	3	3	
5	G	M21 L4V 504	BEARING ASSEMBLY		2	2	2	2	2	2	
6	G	M21 L4V 235	NOZZLE ASSEMBLY (LOWER)		1	1	1	1	1	1	
7	G	M21 L5V 306	DAMPER MOTOR	MV2	1	1	1	1	1	1	UP & DOWN
8	G	M21 L3V 506	VANE MOTOR SUPPORT		1	1	1	1	1	1	
9	G	M21 L3V 049	SM SHAFT		1	1	1	1	1	1	
10	G	M21 L3V 047	DAMPER LIMIT SWITCH (CLOSE)	LS2	1	1	1	1	1	1	
11	G	M21 L4V 047	DAMPER LIMIT SWITCH (OPEN)	LS1	1	1	1	1	1	1	
12	G	M21 L4V 306	DAMPER LOCK MOTOR	ML1,2	2	2	2	2	2	2	RIGHT & LEFT
13	G	M21 L3V 703	DRAIN HOSE		1	1	1	1	1	1	
14	G	M21 L3V 041	DAMPER		1	1	1	1	1	1	
15	G	M21 L4V 049	LOCK SHAFT		2	2	2	2	2	2	
16	G	M21 L4V 302	LINE FLOW FAN (LOWER)		1	1	1	1	1	1	
17	G	M21 L4V 300	INDOOR FAN MOTOR ASSEMBLY (LOWER)*	MF2	1	1	1	1	1	1	RC0J30- <input type="checkbox"/> <input type="checkbox"/>
18	G	M21 L3V 023	MOTOR BAND		2	2	2	2	2	2	
19	G	T2W L3V 376	TERMINAL BLOCK	TB	1	1	1	1	1	1	
20	G	M21 L3V 307	ROOM TEMPERATURE THERMISTOR	RT11	1	1	1	1	1	1	
21	G	T2W L3V 450	ELECTRONIC CONTROL P.C. BOARD		1	1					AUTO RESTART
	G	T2W L4V 450	ELECTRONIC CONTROL P.C. BOARD				1	1			AUTO RESTART
	G	T2W L5V 450	ELECTRONIC CONTROL P.C. BOARD						1	1	AUTO RESTART
22	G	M21 L3V 328	DISPLAY RECEIVER SWITCH P.C. BOARD		1	1	1	1	1	1	
23	G	T2W L3V 043	LAMP COVER		1	1	1	1	1	1	
24	G	M21 L3V 306	HORIZONTAL VANE MOTOR UNIT	MV1	1	1	1	1	1	1	UP & DOWN
25	G	M21 L3V 300	INDOOR FAN MOTOR ASSEMBLY (UPPER)*	MF1	1	1	1	1	1	1	RC0J30- <input type="checkbox"/> <input type="checkbox"/>
26	G	M21 L3V 302	LINE FLOW FAN (UPPER)		1	1	1	1	1	1	
(27)	G	T2W L3V 382	FUSE	F11	1	1	1	1	1	1	T3.15AL250V
(28)	G	T2W L3V 384	VARISTOR	NR11	1	1	1	1	1	1	

* Including fan motor rubber mount (2PCS/SET)

RoHS PARTS LIST (RoHS compliant)

MFZ-KA25VA

MFZ-KA35VA

MFZ-KA50VA

13-4. INDOOR UNIT HEAT EXCHANGER

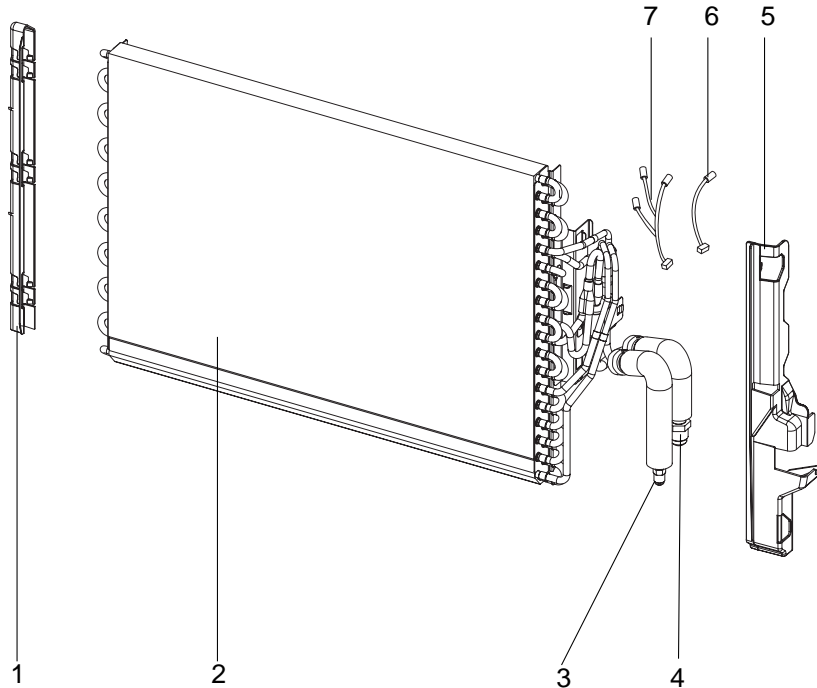

13-4. INDOOR UNIT HEAT EXCHANGER

No.	RoHS	Part No.	Part name	Symbol in Wiring Diagram	Q'ty/unit						Remarks
					MFZ-KA						
					25VA -		35VA -		50VA -		
E1	E2	E1	E2	E1	E2						
1	G	M21 L3V 638	HAIR PIN COVER		1	1	1	1	1	1	
2	G	M21 L3V 620	INDOOR HEAT EXCHANGER		1	1	1	1			
	G	M21 L5V 620	INDOOR HEAT EXCHANGER						1	1	
3	G	M21 L3V 664	UNION (LIQ)		1	1	1	1	1	1	φ 6.35
4	G	M21 L3V 663	UNION (GAS)		1	1	1	1			φ 9.52
	G	M21 L5V 663	UNION (GAS)						1	1	φ 12.7
5	G	M21 L3V 791	WATER COVER		1	1	1	1	1	1	
6	G	M21 L4V 305	INDOOR COIL THERMISTOR	RT13	1	1	1	1	1	1	
7	G	M21 L3V 305	INDOOR COIL THERMISTOR SET	RT12,14,15	1	1	1	1	1	1	3PCS/SET

AIR CLEANING FILTER (ANTI-ALLERGY ENZYME FILTER)

- AIR CLEANING FILTER removes fine dust of 0.01 micron from air by means of static electricity.
- Normal life of AIR CLEANING FILTER is 1 year.
If AIR CLEANING FILTER is to be washed, soak AIR CLEANING FILTER in water (when showing dirt, in lukewarm water) and rinse it delicately, without removing the filter from the frame about once every 3 months.
- Clogged AIR CLEANING FILTER may reduce the air conditioner capacity or cause frost on the air outlet.
- Do not remove or attach AIR CLEANING FILTER during unit operation.

Model	Part No.
MFZ-KA25VA- E1	MAC-415FT-E
MFZ-KA25VA- E2	
MFZ-KA35VA- E1	
MFZ-KA35VA- E2	
MFZ-KA50VA- E1	
MFZ-KA50VA- E2	

Replacement of the air cleaning filter

(1) Remove the catechin air filter.

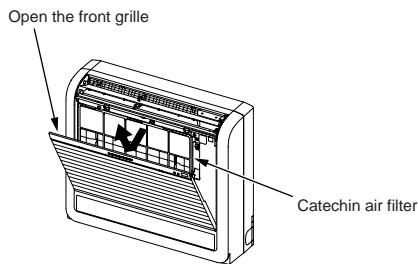

(3) Attach a new air cleaning filter. Fix the filter with the tabs securely.

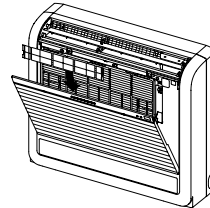

(2) Remove the air cleaning filter.

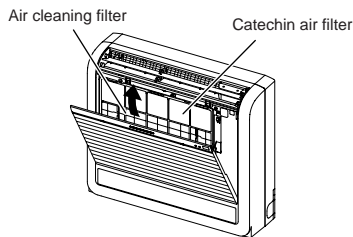

(4) Install the catechin air filter. Be sure to install its both ends into the tabs as shown below.

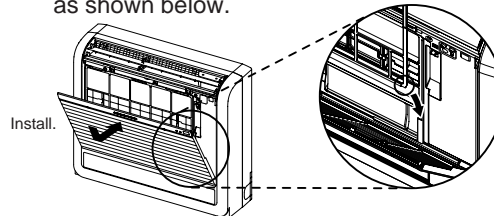

(5) Securely close the front grille.



© Copyright 2005 MITSUBISHI ELECTRIC ENGINEERING CO.,LTD
Distributed in Jun. 2006. No. OB409 REVISED EDITION-A 8
Distributed in May 2005. No. OB409 8
Made in Japan

New publication, effective Jun. 2006
Specifications subject to change without notice.