

FLOOR-TYPE AIR CONDITIONERS

INDOOR UNIT

MFZ-KA25VA MFZ-KA35VA MFZ-KA50VA



OPERATING INSTRUCTIONS

For user

- To use this unit correctly and safely, be sure to read this operating instructions before use.

BEDIENUNGSANLEITUNG

Für Kunden

- Um diese Einheit richtig und sicher zu verwenden, unbedingt diese Bedienungsanleitung vor der Inbetriebnahme durchlesen.

NOTICE D'UTILISATION

A l'attention des clients

- Pour avoir la certitude d'utiliser cet appareil correctement et en toute sécurité, veuillez lire attentivement cette notice d'instructions avant de mettre l'appareil en fonction.

BEDIENINGSINSTRUCTIES

Voor de klant

- Om dit apparaat op de juiste manier en veilig te gebruiken, dient u eerst deze gebruiksaanwijzing aandachtig door te lezen.

MANUAL DE INSTRUCCIONES

Para los clientes

- Para emplear correctamente este aparato y por razones de seguridad debe leer este manual de instrucciones de manejo antes de su utilización.

LIBRETTO D'ISTRUZIONI

Per gli utenti

- Per utilizzare correttamente quest'unità, leggere questo libretto d'istruzioni attentamente e per intero.

ΟΔΗΓΙΕΣ ΛΕΙΤΟΥΡΓΙΑΣ

Για το χρήστη

- Για να χρησιμοποιήσετε αυτή την μονάδα σωστά και με ασφάλεια, βεβαιωθείτε ότι έχετε διαβάσει αυτό το εγχειρίδιο οδηγιών πριν από την χρήση.

INSTRUÇÕES DE OPERAÇÃO

Para o utilizador

- Para utilizar esta unidade correctamente, certifique-se de que lê estas instruções de operação antes da utilização.

BETJENINGSVEJLEDNING

Til kunden

- Læs denne brugsanvisning før brugen så korrekt og forsvarlig anvendelse af klima-anlægget sikres.

BRUKSANVISNING

För användaren

- För att använda enheten på rätt och säkert sätt ska denna bruksanvisning läsas innan enheten tas i bruk.

ÇALIŞTIRMA TALİMATLARI

Kullanıcı için

- Bu birimi doğru ve güvenli olarak çalıştırmak için, kullanmadan önce bu işletme talimatlarını mutlaka okuyun.

ИНСТРУКЦИИ ПО ЭКСПЛУАТАЦИИ

Для пользователя

- Для обеспечения правильного и безопасного использования прибора следует до начала его эксплуатации внимательно прочитать данное руководство.

English

Deutsch

Français

Nederlands

Español

Italiano

Ελληνικά

Português

Dansk

Svenska

Türkçe

Русский



CONTENTS

■ SAFETY PRECAUTIONS	1
■ DISPOSAL	2
■ NAME OF EACH PART	3
■ PREPARATION BEFORE OPERATION	3
■ SELECTING OPERATION MODES	4
■ FAN SPEED AND AIRFLOW DIRECTION ADJUSTMENT	5
■ AIR OUTLET SELECTION	5
■ i-save OPERATION	6
■ ECONO COOL OPERATION	6
■ TIMER OPERATION (ON/OFF TIMER)	6
■ CLEANING	7
■ WHEN YOU THINK THAT TROUBLE HAS OCCURRED	8
■ WHEN THE AIR CONDITIONER IS NOT GOING TO BE USED FOR A LONG TIME	9
■ INSTALLATION PLACE AND ELECTRICAL WORK	9
■ SPECIFICATIONS	9







SAFETY PRECAUTIONS





- Since rotating parts and parts which could cause an electric shock are used in this product, be sure to read these "Safety Precautions" before use.
- Since the cautionary items shown here are important for safety, be sure to observe them.
- After reading this manual, keep it together with the installation manual in a handy place for easy reference.
- Be sure to receive a guarantee card from your dealer and check that the purchased date and shop name, etc. are entered correctly.





Marks and their meanings

-  **WARNING :** Incorrect handling could cause serious hazard, such as death, serious injury, etc. with a high probability.
-  **CAUTION :** Incorrect handling could cause serious hazard depending on the conditions.





Meanings of symbols used in this manual

-  : Be sure not to do.
-  : Be sure to follow the instruction.
-  : Never insert your finger or stick, etc.
-  : Never step onto the indoor/outdoor unit and do not put anything on them.
-  : Danger of electric shock. Be careful.
-  : Be sure to disconnect the power supply plug from the power outlet.
-  : Be sure to shut off the power.

 WARNING	
	<p>Do not connect the power cord to an intermediate point, use an extension cord, or connect multiple devices to a single AC outlet.</p> <ul style="list-style-type: none"> • This may cause overheating, fire, or electric shock. <p>Make sure the power plug is free of dirt and insert it securely into the outlet.</p> <ul style="list-style-type: none"> • A dirty plug may cause fire or electric shock. <p>Do not bundle, pull, or modify the power cord, and do not apply heat or place heavy objects on it.</p> <ul style="list-style-type: none"> • This may cause fire or electric shock. <p>Do not turn the breaker OFF/ON or disconnect/connect the power plug during operation.</p> <ul style="list-style-type: none"> • This may create sparks, which can cause fire. • After the indoor unit is switched OFF at the remote controller, make sure to turn the breaker OFF or disconnect the power plug. <p>Do not expose your body directly to cool air for a prolonged length of time.</p> <ul style="list-style-type: none"> • This could be detrimental to your health. <p>The unit should not be installed, relocated, or repaired by the user.</p> <ul style="list-style-type: none"> • An improperly handled air conditioner may cause fire or electric shock.
 	<p>Do not insert your finger, a stick, or other objects into the air inlet or outlet.</p> <ul style="list-style-type: none"> • This may cause injury, since the fan inside is rotating at high speeds.





 	<p>In case of an abnormal condition (such as a burning smell), stop the air conditioner and disconnect the power plug or turn the breaker OFF.</p> <ul style="list-style-type: none"> • A continued operation in the abnormal state may cause a malfunction, fire, or electric shock. In this case, consult your dealer.
	<p>When the air conditioner does not cool or heat, there is a possibility of refrigerant leakage. In this case, consult your dealer. If a repair involves recharging the unit with refrigerant, ask the service technician for details.</p> <ul style="list-style-type: none"> • The refrigerant used in the air conditioner is safe. Normally, it does not leak. However, if refrigerant leaks and comes in contact with a heat source such as a fan heater, kerosene heater, or portable cooking stove, it will create a harmful gas.
 CAUTION	
	<p>Do not touch the air inlet or the aluminum fins of the indoor/outdoor unit.</p> <ul style="list-style-type: none"> • This may cause injury. <p>Do not use insecticides or flammable sprays on the unit.</p> <ul style="list-style-type: none"> • This may cause a fire or deformation of the unit. <p>Do not expose pets or houseplants to direct airflow.</p> <ul style="list-style-type: none"> • This may cause injury to the pets or plants. <p>Do not place other electric appliances or furniture under the indoor/outdoor unit.</p> <ul style="list-style-type: none"> • Water may drip down from the unit, which may cause damage or malfunction. <p>Do not leave the unit on a damaged installation stand.</p> <ul style="list-style-type: none"> • The unit may fall and cause injury.

SAFETY PRECAUTIONS

 CAUTION	
	Do not step on an unstable bench to operate or clean the unit. • This may cause injury if you fall down.
	Do not pull on the power cord. • This may cause a portion of the core wire to break, which may cause overheating or fire.
	Do not charge or disassemble the batteries, and do not throw them into a fire. • This may cause the batteries to leak, or cause a fire or explosion.
	Do not operate the unit for a long time at high humidity (80% RH or more), such as with a door or window left open. • The water condensation in the air conditioner may drip down, wetting or damaging the furniture.
	Do not use the unit for special purposes, such as storing food, raising animals, growing plants, or preserving precision devices or art objects. • This may cause deterioration of quality, or harm to animals and plants.
	Do not expose combustion appliances to direct airflow. • This may cause incomplete combustion.
	Before cleaning the unit, switch it OFF and disconnect the power plug or turn the breaker OFF. • This may cause injury, since the fan inside is rotating at high speeds during operation.
	When the unit will be unused for a long time, disconnect the power plug or turn the breaker OFF. • Otherwise, the unit may accumulate dirt, which may cause overheating or fire.
	Replace both batteries of the remote controller with new ones of the same type. • Using an old battery together with a new one may cause overheating, leakage, or explosion.
	If the battery fluid comes in contact with your skin or clothes, wash them thoroughly with clean water. • If the battery fluid comes in contact with your eyes, wash them thoroughly with clean water and immediately seek medical attention.
	Ensure that the area is well-ventilated when the unit is operated together with a combustion appliance. • Inadequate ventilation may cause oxygen starvation.
	Turn the breaker OFF when you hear thunder and there is a possibility of a lightning strike. • The unit may be damaged if lightning strikes.
	Do not operate switches with wet hands. • This may cause electric shock.
	Do not clean the air conditioner with water or place an object that contains water, such as a flower vase, on it. • This may cause fire or electric shock.

	Do not step on or place any object on the outdoor unit. • This may cause injury if you or the object falls down.
	After the air conditioner is used for several seasons, perform inspection and maintenance in addition to normal cleaning. • Dirt or dust in the unit may create an unpleasant odor or clog the drain passage, and cause water to leak from the indoor unit. Consult your dealer for inspection and maintenance, which require specialized knowledge and skills.

For installation

 WARNING	
	Consult your dealer for installing the air conditioner. • It should not be installed by the user since installation requires specialized knowledge and skills. An improperly installed air conditioner may cause water leakage, fire, or electric shock.
	Provide a dedicated power supply for the air conditioner. • A non-dedicated power supply may cause overheating or fire.
	Do not install the unit where flammable gas could leak. • If gas leaks and accumulates around the outdoor unit, it may cause an explosion.
 CAUTION	
	Earth the unit correctly. • Do not connect the earth wire to a gas pipe, water pipe, lightning rod, or a telephone ground wire. Improper earthing may cause electric shock.
	Install an earth leakage breaker depending on the installation location of the air conditioner (such as highly humid areas). • If an earth leakage breaker is not installed, it may cause electric shock.
	Ensure that the drain water is properly drained. • If the drain passage is improper, water may drip down from the indoor/outdoor unit, wetting and damaging the furniture.
In case of an abnormal condition Immediately stop operating the air conditioner and consult your dealer.	

DISPOSAL

To dispose of this product, consult your dealer.



Note:

This symbol mark is for EU countries only.
This symbol mark is according to the directive 2002/96/EC Article 10 Information for users and Annex IV.

Your MITSUBISHI ELECTRIC product is designed and manufactured with high quality materials and components which can be recycled and reused. This symbol means that electrical and electronic equipment, at their end-of-life, should be disposed of separately from your household waste. Please, dispose of this equipment at your local community waste collection/recycling center. In the European Union there are separate collection systems for used electrical and electronic product. Please, help us to conserve the environment we live in!

NAME OF EACH PART

Indoor unit

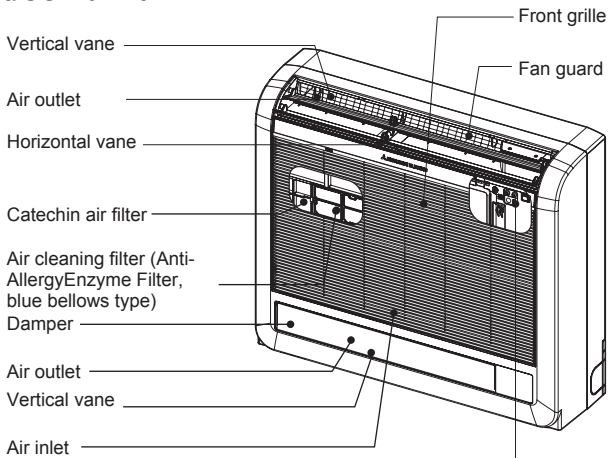

Display and operation section (When the front grille is opened)

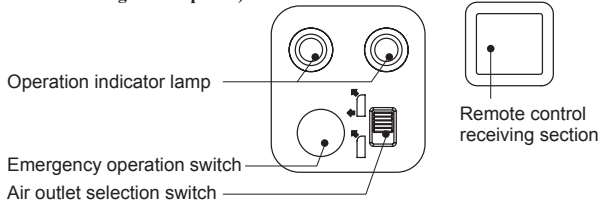

Outdoor unit

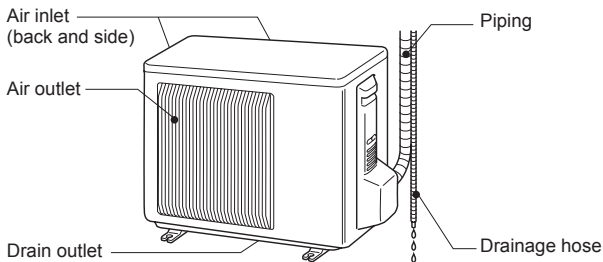

Appearance of the outdoor unit may differ from some models.

Remote controller

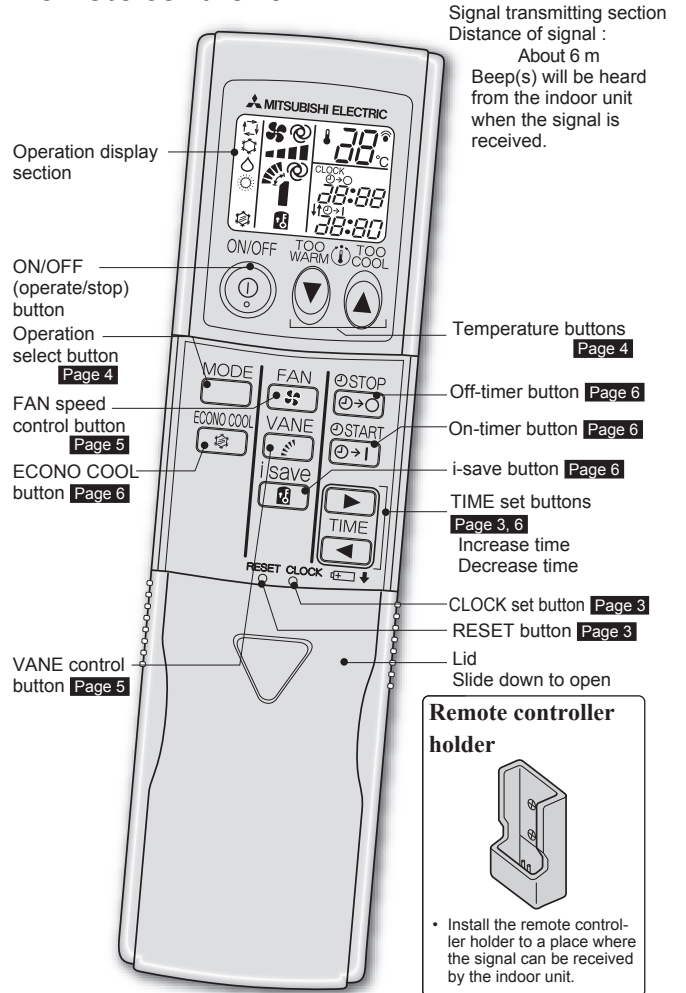

Use the remote controller provided with the unit only.
Do not use other remote controllers.

PREPARATION BEFORE OPERATION

Before operation: Insert the power supply plug into the power outlet and/or turn the breaker on.

Installing the remote controller batteries

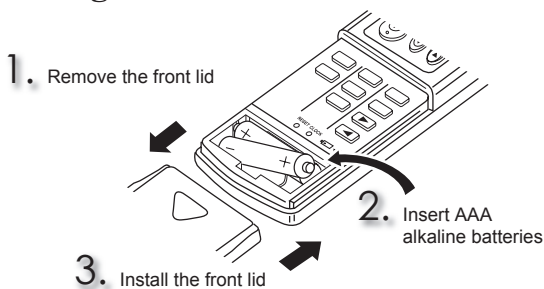

- Make sure the polarity of the batteries is correct.
- Do not use manganese batteries. The remote controller could malfunction.
- Do not use rechargeable batteries.
- Replace all batteries with new ones of the same type.
- Batteries can be used for approximately 1 year. However, batteries with expired shelf lives last shorter.

Setting current time

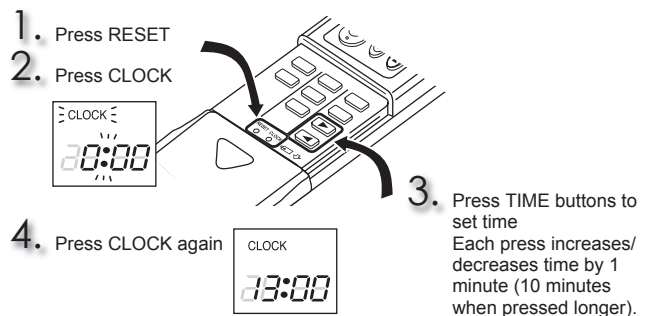

- Press RESET and CLOCK gently using a thin stick. If the RESET button is not pressed, the remote controller may not operate correctly.

SELECTING OPERATION MODES

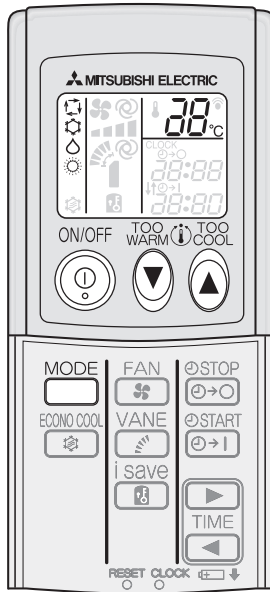

1 Press to start the operation.

2 Press to select operation mode. Each press changes mode in the following order:

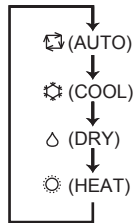

3 Press or to set the temperature. Each press raises or lowers the temperature by 1°C.

Press to stop the operation.
 • The same setting is selected the next time by simply pressing .

Operation indicator lamp

The operation indicator at the right side of the indoor unit indicates the operation state.

Operation Indicator	(Green) : Lighted
	(Orange) : Lighted
	(Green) : Blinking
	(Orange) : Blinking
	: Not lighted

Indication	Operation state	Difference between target temperature and room temperature
	This shows that the air conditioner is operating to reach the target temperature. Please wait until the target temperature is obtained.	About 2°C or more
	This shows that the room temperature is approaching the target temperature.	About 2°C or less
	This shows a state of standby for operation. Please refer to Information for multi system air conditioner above.	—
	Refer to the description of i-save mode.	—

AUTO mode (Auto changeover)

The unit selects the operation mode according to the difference between the room temperature and the set temperature. During AUTO mode, the unit changes mode (COOL↔HEAT) when the room temperature is 2°C away from the set temperature for more than 15 minutes.

Note:

During multi system operation, the unit may not be able to switch operation mode between COOL and HEAT. In this case, the indoor unit becomes standby mode.

COOL mode

Enjoy cool air at your desired temperature.

Do not operate COOL mode at low outside temperature (less than -10°C). Water condensed in the unit may drip and wet or damage furniture, etc.

DRY mode

Dehumidify your room. The room may be cooled slightly. Temperature cannot be set during DRY mode.

HEAT mode

Enjoy warm air at your desired temperature.

Emergency operation

When the remote controller cannot be used...

Emergency operation can be activated by pressing the emergency operation switch on the indoor unit.

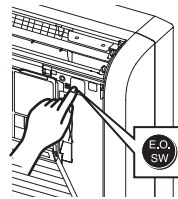

Each time the emergency operation switch is pressed, the operation will change in the following order:

Operation indicator lamp

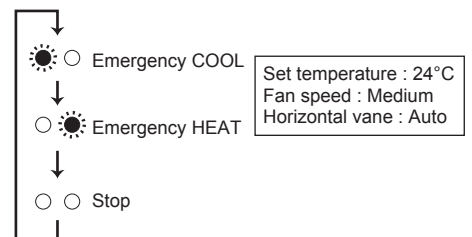

Set temperature : 24°C
 Fan speed : Medium
 Horizontal vane : Auto

Note:

The first 30 minutes of operation is test run. Temperature control does not work, and fan speed is set to High.

Auto restart function

If a power failure occurs or the main power is turned off during operation, "Auto restart function" automatically starts operation in the same mode as the one set with the remote controller just before the shutoff of the main power. When timer is set, timer setting is cancelled and the unit starts operation when power is resumed.

If you do not want to use this function, please consult the service representative because the setting of the unit needs to be changed.

Multi system operation

Two or more indoor units can be operated by one outdoor unit. When several indoor units are operated simultaneously, cooling and heating operations cannot be done at the same time. When COOL is selected with one unit and HEAT with another or vice versa, the unit operated later becomes standby mode.

FAN SPEED AND AIRFLOW DIRECTION ADJUSTMENT

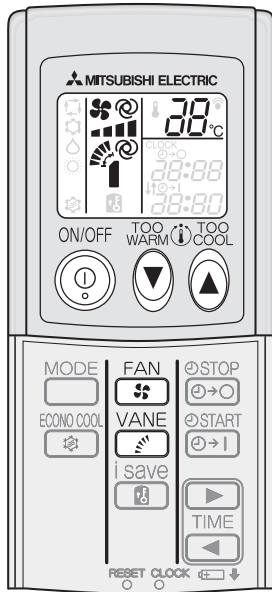

FAN

Press to select fan speed. Each press will change fan speed in the following order:



• Two short beeps will be heard from the indoor unit when set to AUTO.

VANE

Press to select vertical airflow direction. Each press will change airflow direction in the following order:

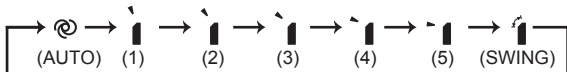

- Two short beeps will be heard from the indoor unit when set to AUTO.
- Moving the horizontal vane manually can cause trouble.
- The horizontal vane automatically moves in certain intervals to determine its position, and then it returns to the set position.

Airflow direction

(AUTO).....The vane will be set to the most efficient airflow direction.
 COOL/DRY : position (1)
 HEAT (upper and lower air outlets) : position (3)
 HEAT (upper air outlet only) : position (5)

(Manual).....For efficient air conditioning, select upper position for COOL/DRY, and lower position for HEAT. During COOL/DRY, when the vane is set to position (3), (4), or (5), the vane automatically moves to position (1) after 0.5 to 1 hour to prevent water dripping.

(Swing).....The vane will move up and down intermittently.

■ **To change the horizontal airflow direction.**
 Move the vertical vane manually before starting operation.

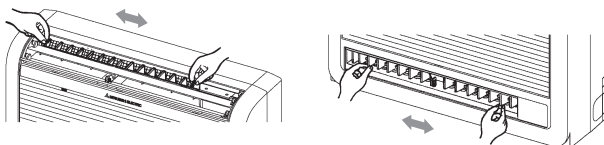

Always adjust the vane when the damper is open. Opening the damper forcibly with hands can cause damage or malfunction.

AIR OUTLET SELECTION

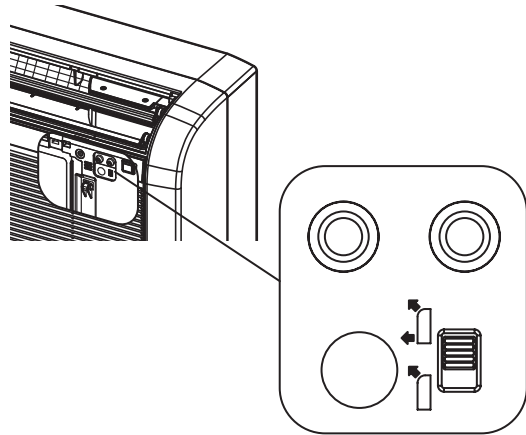

Select to blow air from the upper and lower air outlets.

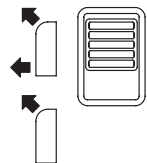

- Air will blow only from the upper outlet in the following conditions:
- During COOL: When the room temperature is close to set temperature. When the air conditioner has operated for 1 hour.
 - During DRY operation.
 - During HEAT: When the air flow temperature is low.
 (During defrosting operation, start of operation, etc.)

Select to blow air from the upper air outlet only.

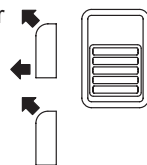

Note:

Be sure to keep the area around the damper of the lower air outlet free of any objects. If any objects block the normal operation of the damper, the left operation indicator lamp may blink.
 Set the air outlet selection switch to the end. Otherwise, air outlet cannot be selected as intended.

i-save OPERATION

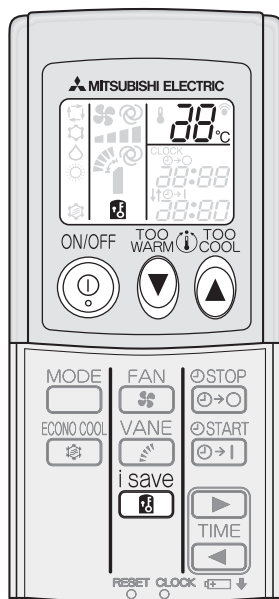

- 1 Press to select i-save mode. Select i-save during COOL, ECONO COOL, or HEAT operation.
 - The operation indicator lamp on the right side of the indoor unit lights in orange.

- 2 Set the temperature, fan speed, and air flow direction.
 - The same setting will be selected from the next time by simply pressing .
 - Two groups of setting can be saved. (one for COOL/ECONO COOL, one for HEAT)

Press again to cancel i-save operation.

- Pressing will also cancel i-save operation.
- The operation indicator lamp on the right side of the indoor unit turns off or changes from orange to green.

i-save operation

A simplified set back function enables to recall the preferred (preset) setting with a single push of the button. Press the button again and you can go back to the previous setting in an instance.

Example of use:

1. Low energy mode
Set the temperature 2 to 3°C warmer in COOL and cooler in HEAT mode. This setting is suitable for unoccupied room, and while you are sleeping.
2. Saving frequently used settings
Save your preferred setting for COOL/ECONO COOL and HEAT. This enables you to select your preferred setting with a single push of the button.

ECONO COOL OPERATION

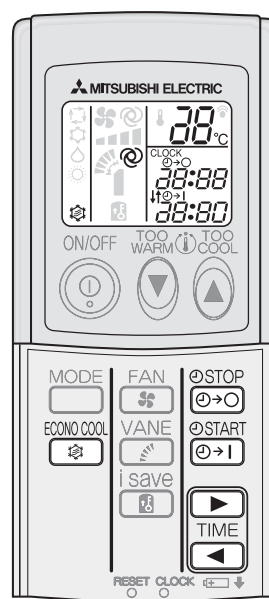

Press during COOL mode [page 4](#) to start ECONO COOL operation.

The unit performs swing operation vertically in various cycle according to the temperature of the unit. Set temperature is set 2°C higher automatically.

Press again to cancel ECONO COOL operation.

- Pressing also cancels ECONO COOL operation.

What is "ECONO COOL"?

Swing air flow (change of air flow) makes you feel cooler than constant air flow. So, even though the set temperature is automatically set 2°C higher, it is possible to perform cooling operation with keeping comfort. As a result, energy can be saved.

TIMER OPERATION (ON/OFF TIMER)

- 1 Press or during operation to set the timer.

(ON timer) : The unit turns ON at the set time.

(OFF timer) : The unit turns OFF at the set time.

* or blinks.

* Make sure that the current time is set correctly. [Page 3](#)

- 2 Press (Increase) and (Decrease) to set the time of timer.
Each press increases or decreases the set time by 10 minutes.

- 3 Press or again to cancel timer.

Note:

- ON and OFF timers can be used in combination. ↓↑ mark indicates the order of timer operations.
- If power failure occurs while ON/OFF timer is set, see [page 4](#) "Auto restart function".

CLEANING

Instructions:

- Switch off the power supply or turn off the breaker before cleaning.
- Be careful not to touch the metal parts with your hands.
- Do not use benzine, thinner, polishing powder, or insecticide.
- Use only diluted mild detergents.
- Do not expose parts to direct sunlight, heat, or flames to dry.
- Do not water hotter than 50°C.

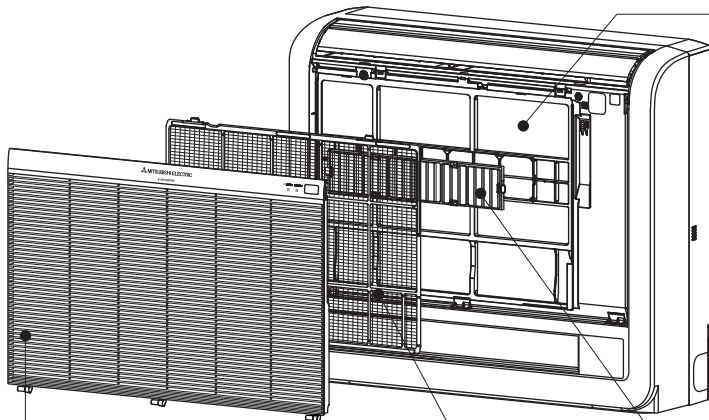

Front grille

1. Push the 2 positions indicated by the arrows until a click is heard, and open the front grille.
2. Unhook the string which holds the grille.
3. Open the grille completely and then remove it.
 - Wipe with a soft dry cloth or wash it with water.
 - Do not soak it in water for more than two hours.
 - Dry it well in shade before installing it.
4. Install the grille by following the removal procedure in reverse. Be sure to hook the string before closing the grille.

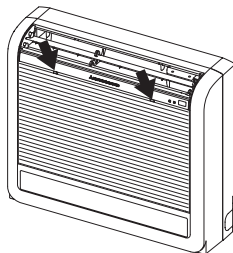

Heat exchanger

- Wear gloves to protect your hands.
- Use the QUICK CLEAN KIT (optional).
Parts Number **MAC-093SS-E**
- Refer to the instructions described in the QUICK CLEAN KIT for details.

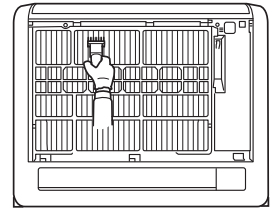

Note:

- Clean the filters regularly for best performance and to reduce power consumption.
- Please consult your dealer for seasonal inspection.

Air cleaning filter

- **Clean every 3 months.**
- Soak the filter together with its frame in lukewarm water and wash it.
- After cleaning, dry it well in shade and put it back to its original position. Install all tabs of the air filter.
- Replace it with a new air cleaning filter **every year** for best performance.
- Parts Number **MAC-415FT-E**

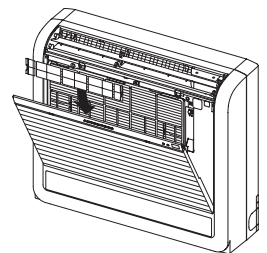

Air filter (Catechin air filter)

- **Clean every 2 weeks**
- Remove dirt by a vacuum cleaner, or wash with water.
- Dry it well in shade before installing it.

What is "Catechin air filter" ?

The air filter is dyed with a natural material, catechin, that is contained in tea. The catechin air filter deodorizes odor and noxious gases such as formaldehyde, ammonia, and acetaldehyde. Moreover, it restrains the activity of the viruses adhering to the filter.

WHEN YOU THINK THAT TROUBLE HAS OCCURRED

Even if these items are checked, when the unit does not recover from the trouble, stop using the air conditioner and consult your dealer.

Symptom	Explanation & Check points
Indoor Unit	
The unit cannot be operated.	<ul style="list-style-type: none"> Is the breaker turned on? Is the power supply plug connected? Is the ON timer set? Is there anything that block the normal operation of the damper? Page 5
The unit cannot be operated for about 3 minutes when restarted.	<ul style="list-style-type: none"> This protects the unit according to instructions from the microprocessor. Please wait.
Mist is discharged from the air outlet of the indoor unit.	<ul style="list-style-type: none"> The cool air from the unit rapidly cools moisture in the air inside the room, and it turns into mist.
The swing operation of the HORIZONTAL VANE is suspended for a while, then restarted.	<ul style="list-style-type: none"> This is for the swing operation of the HORIZONTAL VANE to be performed normally.
The air flow direction changes during operation. The direction of the horizontal vane cannot be adjusted with the remote controller.	<ul style="list-style-type: none"> In the heating operation, if the air flow temperature is too low or when defrosting is being done, the horizontal vane is automatically set to horizontal position. When the air conditioner is operated in COOL or DRY mode, if the operation continues with air blowing down for 1 hour, the direction of the air flow is automatically set to position (1) to prevent condensed water from dropping. In the heating operation, if the air flow temperature is too low or when defrosting is being done, the horizontal vane position is automatically set to horizontal. The horizontal vane automatically moves in certain intervals to determine its position, and then it returns to the set position.
The operation is stopped for about 10 minutes in the heating operation.	<ul style="list-style-type: none"> Defrosting of the outdoor unit is being done. Since this is completed in max. 10 minutes, please wait. (When the outside temperature is too low and humidity is too high, frost is formed.)
The unit starts operation by itself when the main power is turned on, though it isn't operated with the remote controller.	<ul style="list-style-type: none"> These models are equipped with an auto restart function. When the main power is turned off without stopping the unit with the remote controller and is turned on again, the unit starts operation automatically in the same mode as the one set with the remote controller just before the shutoff of the main power. Refer to "Auto restart function" page 4.
The damper opens and closes automatically.	<ul style="list-style-type: none"> The damper is automatically controlled by a microcomputer according to the air flow temperature and operation time of the air conditioner.
Multi system	
The indoor unit which is not operating becomes warm and a sound, similar to water flowing, is heard from the unit.	<ul style="list-style-type: none"> A small amount of refrigerant continues to flow into the indoor unit even though it is not operating.
When heating operation is selected, operation does not start right away.	<ul style="list-style-type: none"> When operation is started during defrosting of outdoor unit is done, it takes a few minutes (max. 10 minutes) to blow out warm air.
Outdoor Unit	
The fan of the outdoor unit does not rotate even though the compressor is running. Even if the fan starts to rotate, it stops soon.	<ul style="list-style-type: none"> When the outside temperature is low during cooling operation, the fan operates intermittently to maintain sufficient cooling capacity.
Water leaks from the outdoor unit.	<ul style="list-style-type: none"> During COOL and DRY operations, pipe or pipe connecting sections are cooled and this causes water to condense. In the heating operation, water condensed on the heat exchanger drips down. In the heating operation, the defrosting operation makes water frozen on the outdoor unit melt and drip down.

Symptom	Explanation & Check points
White smoke is discharged from the outdoor unit.	<ul style="list-style-type: none"> In the heating operation, vapor generated by the defrosting operation looks like white smoke.
Remote controller	
The display on the remote controller does not appear or it is dim. The indoor unit does not respond to the remote control signal.	<ul style="list-style-type: none"> Are the batteries exhausted? Page 3 Is the polarity (+, -) of the batteries correct? Page 3 Are any buttons on the remote controller of other electric appliances being pressed?
Does not cool or heat	
The room cannot be cooled or heated sufficiently.	<ul style="list-style-type: none"> Is the temperature setting appropriate? Page 4 Is the fan setting appropriate? Please change fan speed to higher setting. Page 5 Is the air outlet selection switch set to upper air outlet only? Change to upper and lower air outlets. Page 5 Is the filter clean? Page 7 Is the fan or heat exchanger of the indoor unit clean? Page 7 Are there any obstacles blocking the air inlet or outlet of the indoor or outdoor unit? Is a window or door open?
The room cannot be cooled sufficiently.	<ul style="list-style-type: none"> When a ventilation fan or a gas cooker is used in a room, the cooling load increases, resulting in an insufficient cooling effect. When the outside temperature is high, the cooling effect may not be sufficient.
The room cannot be heated sufficiently.	<ul style="list-style-type: none"> When the outside temperature is low, the heating effect may not be sufficient.
Air does not blow out soon in the heating operation.	<ul style="list-style-type: none"> Please wait as the unit is preparing to blow out warm air.
Airflow	
The air from the indoor unit smells strange.	<ul style="list-style-type: none"> Is the filter clean? Page 7 Is the fan or heat exchanger of the indoor unit clean? Page 7 The unit may suck in an odor adhering to the wall, carpet, furniture, cloth, etc. and blow it out with the air.
Sound	
Cracking sound is heard.	<ul style="list-style-type: none"> This sound is generated by the expansion/contraction of the intake grille, etc. due to change in temperature.
The sound as burbling is heard.	<ul style="list-style-type: none"> This sound is heard when the outside air is absorbed from the drain hose by turning on the range hood or the ventilation fan, making water flowing in the drain hose to spout out. This sound is also heard when the outside air blows into the drain hose in case the outside wind is strong.
Burbling sound is heard from the indoor unit when DRY/COOL operation is stopped.	<ul style="list-style-type: none"> This is the sound of drained water flowing backward in the drain piping in the ceiling.
Mechanical sound is heard from the indoor unit.	<ul style="list-style-type: none"> This is the switching sound in turning on/off the fan or the compressor.
The sound of water flowing is heard.	<ul style="list-style-type: none"> This is the sound of refrigerant or condensed water flowing in the unit.
Hissing sound is sometimes heard.	<ul style="list-style-type: none"> This is the sound when the flow of refrigerant inside the unit is switched.
The sound of motor and swirling sound is heard from the indoor unit during COOL/DRY operation.	<ul style="list-style-type: none"> This is the sound of water being drained from the indoor unit.

In the following cases, stop using the air conditioner and consult your dealer.

- When water leaks or drips from the indoor unit.
- When the upper operation indicator lamp blinks.
- When the breaker trips frequently.
- The remote control signal is not received in a room where an electronic ON/OFF type fluorescent lamp (inverter-type fluorescent lamp, etc.) is used.
- Operation of the air conditioner interferes with radio or TV reception. An amplifier may be required for the affected device.
- When an abnormal sound is heard.

WHEN THE AIR CONDITIONER IS NOT GOING TO BE USED FOR A LONG TIME

1 Set to the highest temperature in manual COOL mode, and operate for 3 to 4 hours. **Page 4**
This dries the inside of the unit.

2 Press  to stop the operation.

3 Turn off the breaker and/or disconnect the power supply plug.

4 Remove all batteries from the remote controller.

When using the air conditioner again:

1 Clean the air filter. **Page 7**

2 Check that the air inlet and outlet of the indoor and outdoor units are not blocked.

3 Check that the earth is connected correctly.

INSTALLATION PLACE AND ELECTRICAL WORK

Installation place

Avoid installing the air conditioner in the following places.

- Where there is much machine oil.
- Salty places such as the seaside.
- Where sulfide gas is generated such as a hot spring.
- Where oil is splashed or where the area is filled with oily smoke.
- Where there is high-frequency or wireless equipment.
- Where the air from the outdoor unit air outlet is blocked.
- Where the operation sound or air from the outdoor unit does not bother the house next door.

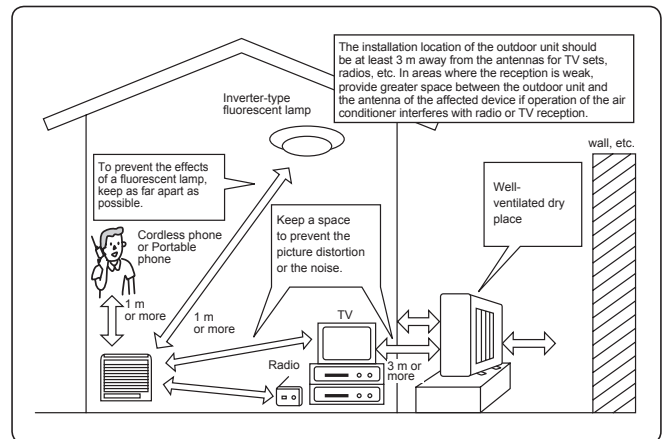

Electrical work

- Provide an exclusive circuit for the power supply of the air conditioner.
- Be sure to observe the breaker capacity.

If you have any questions, consult your dealer.

SPECIFICATIONS

Model	Set name		MFZ-KA25VA(H)		MFZ-KA35VA(H)		MFZ-KA50VA	
	Indoor	Outdoor	MFZ-KA25VA	SUZ-KA25VA(H)	MFZ-KA35VA	SUZ-KA35VA(H)	MFZ-KA50VA	SUZ-KA50VA
Function			Cooling	Heating	Cooling	Heating	Cooling	Heating
Power supply			~ /N, 230 V, 50 Hz					
Capacity		kW	2.5	3.4	3.5	4.0	4.8	6.0
Input		kW	0.58	0.835	1.09	1.10	1.55	1.86
Weight	Indoor	kg	14					
	Outdoor	kg	33		37		53	
Refrigerant filling capacity (R410A)		kg	0.90		1.05		1.60	
IP code	Indoor		IP 20					
	Outdoor		IP 24					
Permissible excessive operating pressure	LP ps	MPa	1.64					
	HP ps	MPa	4.15					
Noise level	Indoor (Super High/High/Med./Low)	dB(A)	37/32/27/22	37/32/27/22	38/33/28/25	43/39/35/32	43/39/35/32	44/39/35/32
	Outdoor	dB(A)	46		47	48	53	55

Guaranteed operating range

Model	Indoor	Outdoor			
		SUZ-KA25/35VA	SUZ-KA50VA	SUZ-KA25/35VAH	
Cooling	Upper limit	32°C DB 23°C WB	46°C DB	43°C DB	46°C DB
	Lower limit	21°C DB 15°C WB	-10°C DB	-10°C DB	-10°C DB
Heating	Upper limit	27°C DB	24°C DB	24°C DB	24°C DB
	Lower limit	20°C DB	-10°C DB	-10°C DB	-20°C DB

Note:

Rating condition
 Cooling — Indoor: 27°C DB, 19°C WB Outdoor: 35°C DB
 Heating — Indoor: 20°C DB Outdoor: 7°C DB, 6°C WB

As for the specifications of multi system, please confirm your dealer and/or refer to the catalogue.

This product is designed and intended for use in the residential, commercial and light-industrial environment.

The product at hand is based on the following EU regulations:

- Low Voltage Directive 73/23/ EEC
- Electromagnetic Compatibility Directive 89/336/ EEC



HEAD OFFICE: TOKYO BLDG., 2-7-3, MARUNOUCHI, CHIYODA-KU, TOKYO 100-8310, JAPAN

SG79Y972H01