

1. THE FOLLOWING SHOULD ALWAYS BE OBSERVED FOR SAFETY

- Please provide an exclusive circuit for the air conditioner and do not connect other electrical appliances to it.
- Please report to your supply authority or obtain their consent before connecting this equipment to the power supply system.
- Be sure to read **THE FOLLOWING SHOULD ALWAYS BE OBSERVED FOR SAFETY** before installing the air conditioner.
- Be sure to observe the cautions specified here as they include important items related to safety.
- The indications and meanings are as follows.

WARNING

- **Do not install the unit by yourself (customer).**
Incomplete installation could cause injury due to fire, electric shock, the unit falling or leakage of water. Consult the dealer from whom you purchased the unit or special installer.
- **Install the unit securely in a place which can bear the weight of the unit.**
When installed in an insufficient strong place, the unit could fall causing injury.
- **Use the specified wires to connect the indoor and outdoor units securely and attach the wires firmly to the terminal block connecting sections so the stress of the wires is not applied to the sections.**
Incomplete connecting and fixing could cause fire.
- **Do not use intermediate connection of the power cord or the extension cord and do not connect many devices to one AC outlet.**
It could cause a fire or an electric shock due to defective contact, defective insulation, exceeding the permissible current, etc.
- **Check that the refrigerant gas does not leak after installation has completed.**
If refrigerant gas leaks indoors, and comes into contact with the fire of a fan heater, space heater, stove, etc., harmful substances will be generated.
- **Perform the installation securely referring to the installation manual.**
Incomplete installation could cause a personal injury due to fire, electric shock, the unit falling or leakage of water.
- **Perform electrical work according to the installation manual and be sure to use an exclusive circuit.**
If the capacity of the power circuit is insufficient or there is incomplete electrical work, it could result in a fire or an electric shock.
- **Attach the electrical cover to the indoor unit and the service panel to the outdoor unit securely.**
If the electrical cover in the indoor unit and/or the service panel in the outdoor unit are not attached securely, it could result in a fire or an electric shock due to dust, water, etc.
- **Be sure to use the part provided or specified parts for the installation work.**
The use of defective parts could cause an injury or leakage of water due to a fire, an electric shock, the unit falling, etc.
- **Be sure to cut off the main power in case of setting up the indoor electronic control P.C. board or wiring works.**
It could cause an electric shock.
- **The appliance shall be installed in accordance with national wiring regulations.**
- **When installing or relocating the unit, make sure that no substance other than the specified refrigerant (R410A) enters the refrigerant circuit.**
Any presence of foreign substance such as air can cause abnormal pressure rise or an explosion.

①

3. INSTALLATION DIAGRAM & ACCESSORIES

FLARED CONNECTIONS

- This unit has flared connections on both indoor and outdoor sides.
- Remove the outdoor unit valve cover, then connect the pipe.
- Refrigerant pipes are used to connect the indoor and outdoor units.
- Be careful not to crush or bend the pipe in pipe bending.

Limits	
Pipe length	25 m max.
Height difference	10 m max.
No. of bends	10 max.

- Refrigerant adjustment... If pipe length exceeds 7 m, additional refrigerant (R410A) charge is required. (The outdoor unit is charged with refrigerant for pipe length up to 7 m.)

ACCESSORIES

Check the following parts before installation.	
Installation plate	1
Remote controller holder	2
Fixing screw for 2.5 x 16 mm (Black)	7
Battery (AAA) for remote controller	2
Wireless remote controller	1
Felt tape (Used for left or left-rear piping)	1

PART TO BE PROVIDED AT YOUR SITE

Indoor/outdoor unit connecting wire (2-core 1.0 mm ² -2.0 mm ²)	1
Extension pipe	1
Wall hole sleeve	1
Wall hole cover	1
Pipe fixing band (The quantity depends on the pipe length)	2 to 5
Fixing screw for 4 x 20 mm (The quantity depends on the pipe length)	2 to 5
Piping tape	1
Putty	1
Drain hose (or soft PVC, hose, 15 mm inner dia. or hard PVC pipe VP16)	1
Refrigeration oil	1
Power supply cord (See the table in 5 INDOOR/OUTDOOR WIRE CONNECTION AND OUTDOOR POWER SUPPLY CORD CONNECTION for the cord size)	1

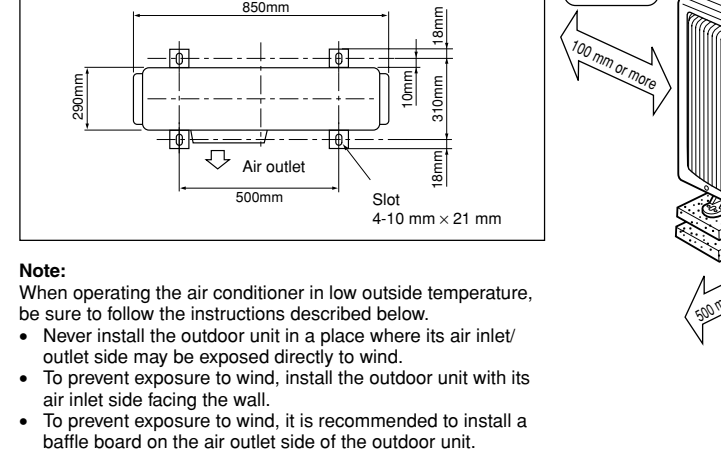

Note: When operating the air conditioner in low outside temperature, be sure to follow the instructions described below.

- Never install the outdoor unit in a place where its air inlet/outlet side may be exposed directly to wind.
- To prevent exposure to wind, install the outdoor unit with its air inlet side facing the wall.
- To prevent exposure to wind, it is recommended to install a baffle board on the air outlet side of the outdoor unit.

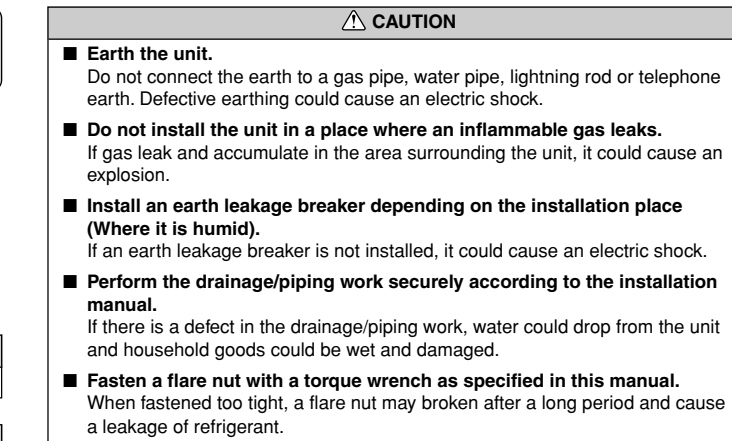

2. SELECTING THE INSTALLATION LOCATION

2-1 INDOOR UNIT

- Where airflow is not blocked.
- Where cool air spreads over the entire room.
- Maximum refrigerant piping length between indoor unit and outdoor unit is 25 m and the difference in height of both units is 10 m.
- Rigid wall without vibration.
- Where it is not exposed to direct sunshine.
- Where it is not exposed to direct rain.
- Where it is easily drained.
- At a distance 1 m or more away from your TV and radio. Operation of the air conditioner interferes with radio or TV reception in areas where reception is weak. An amplifier may be required for the affected device.
- In a place as far away as possible from fluorescent and incandescent lights (so the infrared remote control can operate the air conditioner normally).
- Where the air filter can be removed and replaced easily.

2-2 OUTDOOR UNIT

- Where it is not exposed to strong wind.
- Where airflow is good and dustless.
- Where it is not exposed to rain and direct sunshine.
- Where neighbours are not annoyed by operation sound or hot air.
- Where rigid wall or support is available to prevent the increase of operation sound or vibration.
- Where there is no risk of combustible gas leakage.
- When installing the unit at a high level, be sure to fix the unit legs.
- Where it is at least 3 m away from the antenna of TV set or radio. Operation of the air conditioner interferes with radio or TV reception in areas where reception is weak. An amplifier may be required for the affected device.
- Install the unit horizontally.
- Please install it in an area not affected by snowfall or blowing snow. In areas with heavy snow, please install a canopy, a pedestal and/or some baffle boards.

- Avoid the following places for installation where air conditioner trouble is liable to occur.
 - Where flammable gas could leak.
 - Where there is much machine oil.
 - Slaty places such as the seaside.
 - Where sulfide gas is generated such as a hot spring.
 - Where there is high-frequency or wireless equipment.

2-3 WIRELESS REMOTE CONTROLLER MOUNTING

- Place of mounting
 - Where it is easy to operate and easily visible.
 - Where children can not touch.
- Mounting
 - Select a position about 1.2 m above the floor, check that signals from the remote controller are surely received by the indoor unit from that position ('beep' or 'beep-beep' receiving tone sounds). After that, attach the remote controller holder to a pillar or wall and set the wireless remote controller.

In rooms where inverter type fluorescent lamps are used, the signal from the wireless remote controller may not be received.

4. INDOOR UNIT INSTALLATION

4-1 FIXING OF INSTALLATION PLATE

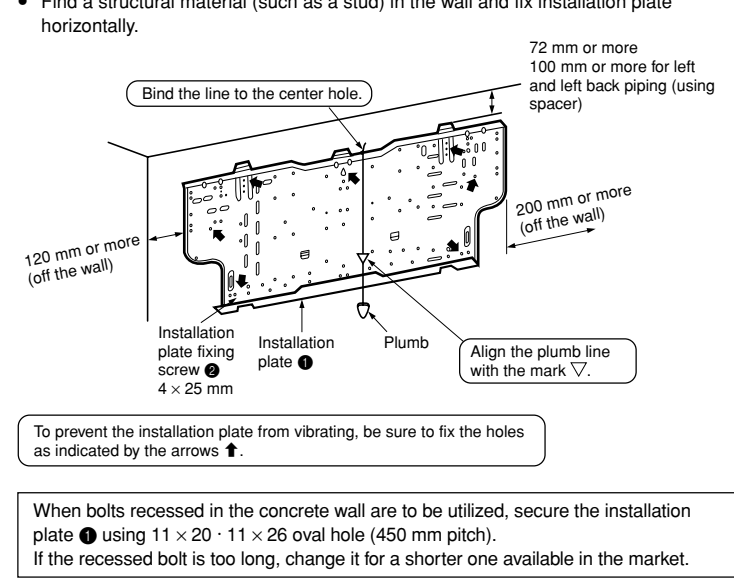

4-2 WALL HOLE DRILLING

- ① Determine the wall hole position.
- ② Drill a 75 mm hole so that outside can be lower than inside.
- ③ Insert the wall hole sleeve.

Positioning of the holes on the wall

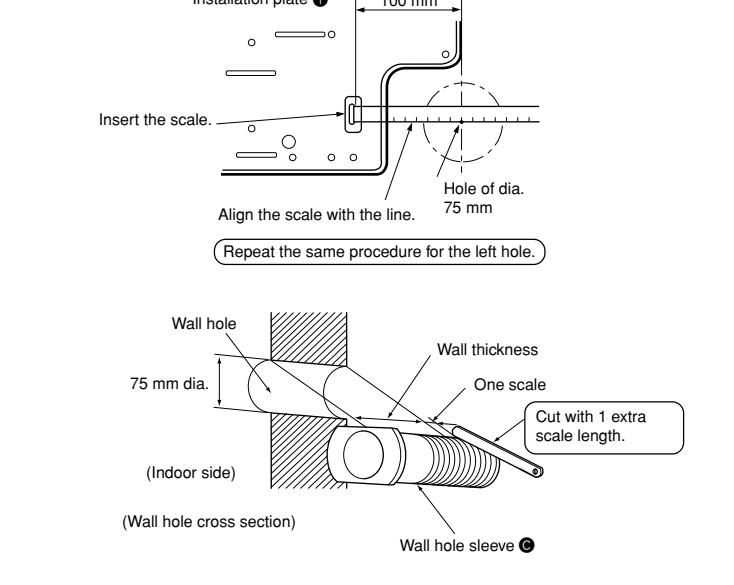

Wall hole sealing and fixing pipe to wall

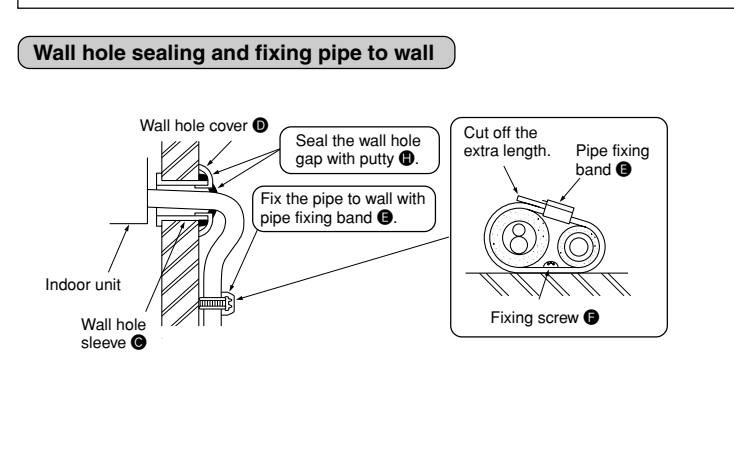

4-3 CONNECTING WIRE SPECIFICATIONS

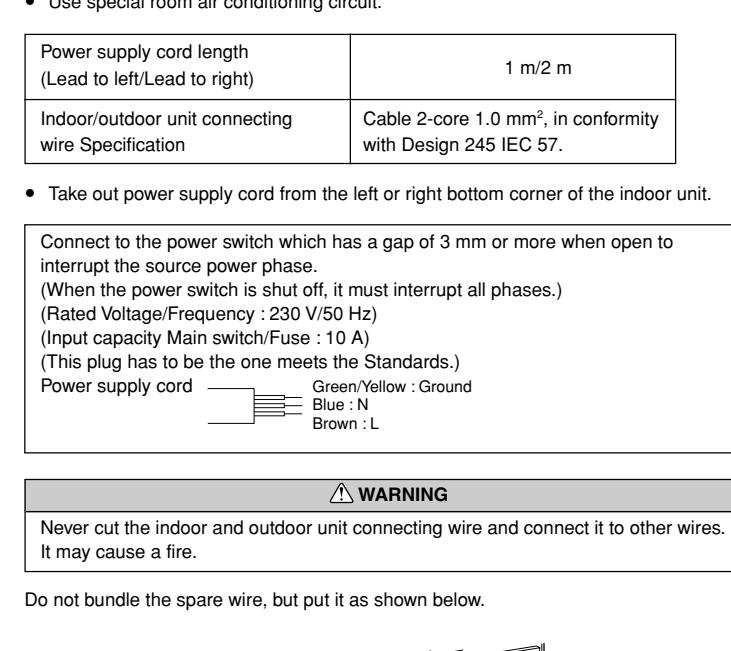

4-4 INDOOR AND OUTDOOR CONNECTING WIRE CONNECTION

- You can connect indoor/outdoor lead wire without removing the front panel.
- ① Open the front panel.
- ② Remove one screw holding the electrical cover, then remove the cover.
- ③ Remove the VA clamp and the cord clamp.
- ④ Pass the indoor/outdoor unit connecting wire from the back of the indoor unit and process the end of the wire, then connect it to the terminal block.
- ⑤ Replace the fixture and electrical cover securely.

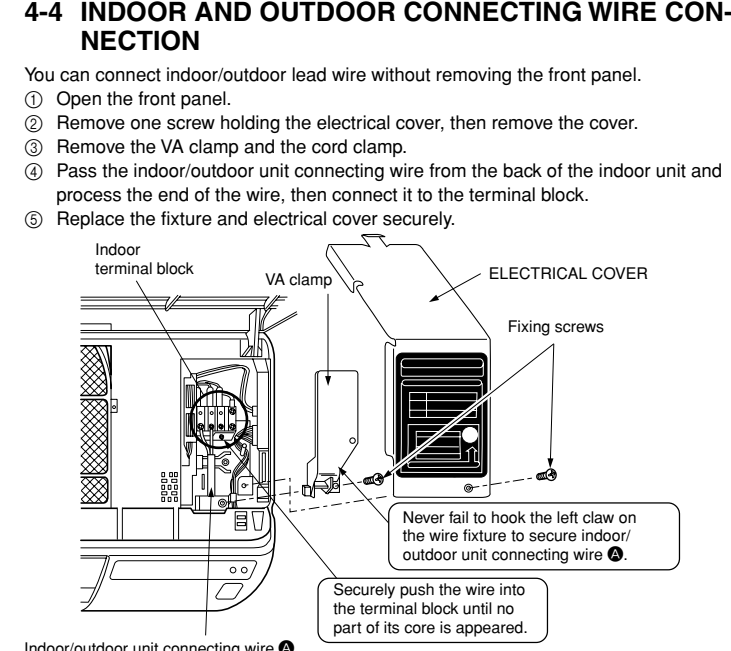

6-2 FLARING WORK

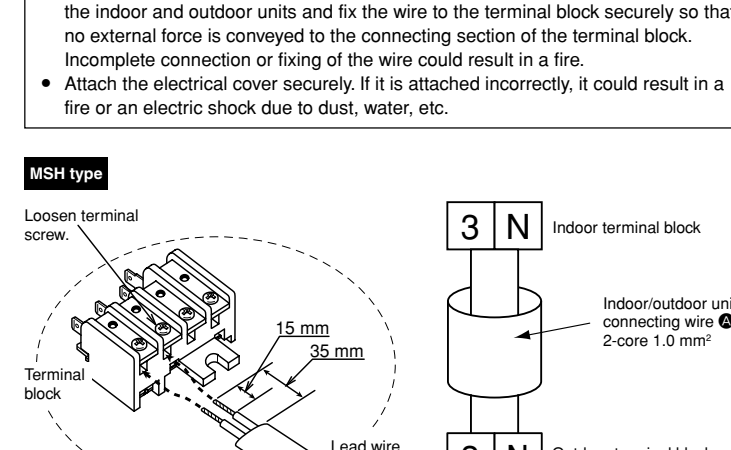

6-3 PIPE CONNECTION

- Fasten a flare nut with a torque wrench as specified in the table below.
- When fastened too tight, a flare nut may be broken after a long period and cause a leakage of refrigerant.

Tightening torque	
Cap for service port	13.7 to 17.7 140 to 180
Cap for stop valve	19.6 to 29.4 200 to 300

6-4 PURGING PROCEDURES-LEAK TEST

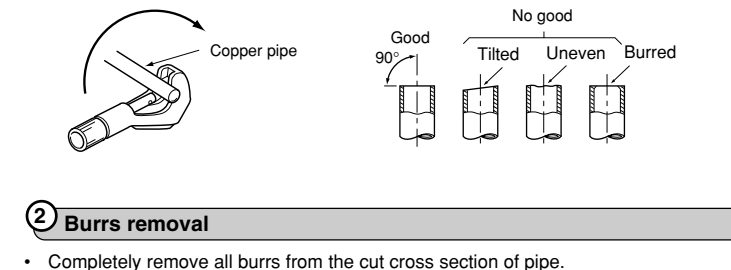

6-5 TEST RUN

- Before performing the test run, recharge for any wrong wiring.
- Wrong wiring prevents normal operation or results in blown fuse disabling operation.
- The test run can be started by pressing EMERGENCY OPERATION switch. When the EMERGENCY OPERATION switch is once pressed, the unit will start the test run (continuous operation) for 30 minutes.
- A thermostat does not work during this time. After 30 minutes the unit will start the EMERGENCY OPERATION at a fixed temperature setting of 24°C in COOL MODE.
- Perform test run in the following procedure.

6-6 PURGING PROCEDURES-LEAK TEST

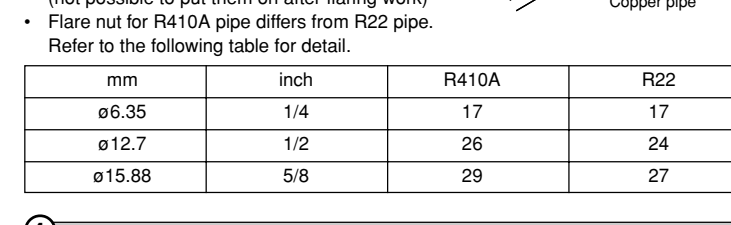

6-7 GAS CHARGE

- Connect gas cylinder to the service port of stop valve (3-way).
- Execute air purge of the pipe (or hose) coming from refrigerant gas cylinder.
- Refill the specified amount of the refrigerant, while operating the air conditioner for cooling.

6-8 REFRIGERANT CHARGE

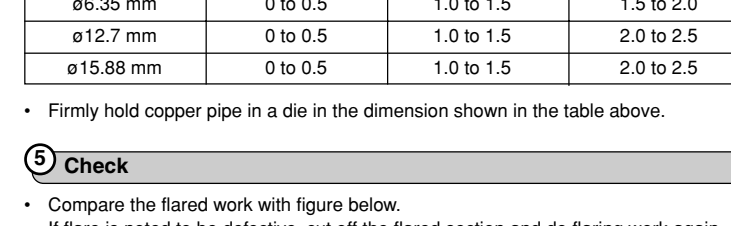

6-9 REFRIGERANT CHARGE

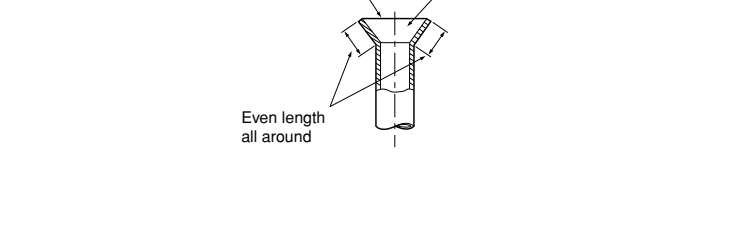

6-10 REFRIGERANT CHARGE

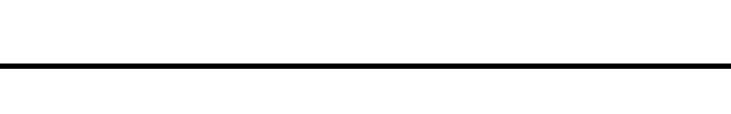

FOR REAR, RIGHT OR DOWNWARD PIPING

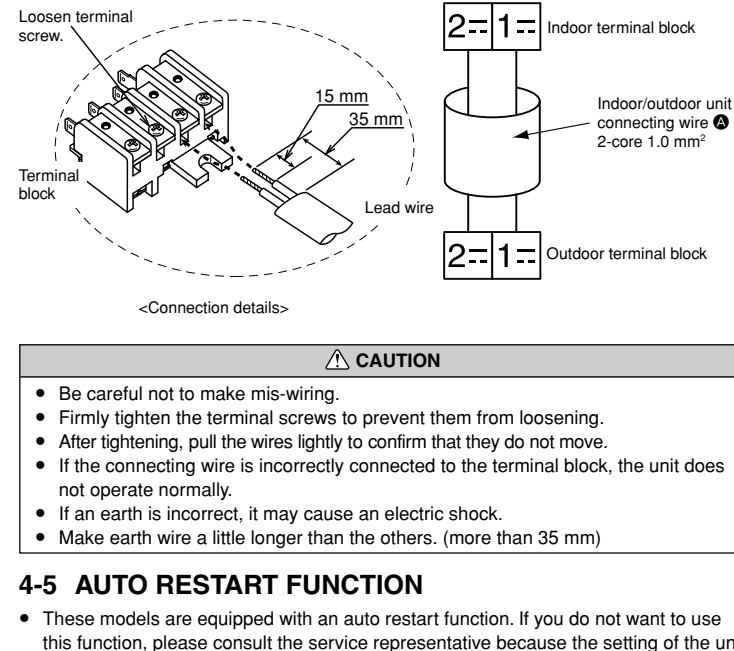

FOR LEFT OR LEFT-REAR PIPING

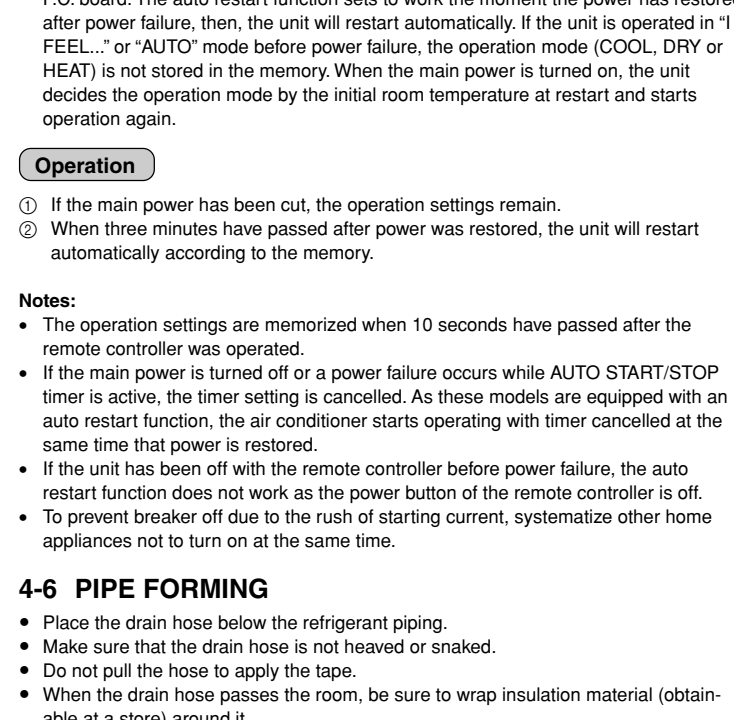

4-5 AUTO RESTART FUNCTION

- These models are equipped with an auto restart function. If you do not want to use this function, please consult the service representative because the setting of the unit needs to be changed.
- When the indoor unit is controlled with the remote controller, the operation mode, set temperature, and the fan speed are memorized by the indoor electronic control P.C. board. The auto restart function sets to work the moment the power has restarted after power failure, then, the unit will restart automatically. If the unit is operated in '1 FEEL...' or 'AUTO' mode before power failure, the operation mode (COOL, DRY or HEAT) is not stored in the memory. When the main power is turned on, the unit decides the operation mode by the initial room temperature at restart and starts operation again.

OPERATION

- ① If the main power has been cut, the operation settings remain.
- ② When three minutes have passed after power was restored, the unit will restart automatically according to the memory.

NOTES:

- The operation settings are memorized when 10 seconds have passed after the remote control was operated.
- If the main power is turned off or a power failure occurs while AUTO START/STOP timer is active, the timer setting is cancelled. As these models are equipped with an auto restart function, the air conditioner starts operating with timer cancelled at the same time that power is restored.
- If the unit has been off with the remote controller before power failure, the auto restart function does not work as the power button of the remote controller is off.
- To prevent breaker off due to the rush of starting current, systematize other home appliances not to turn on at the same time.

4-6 PIPE FORMING

- Flare the drain hose below the refrigerant piping.
- Make sure that the drain hose is not heaved or snaked.
- Do not pull the hose to apply the tape.
- When the drain hose passes the room, be sure to wrap insulation material (obtainable at a store) around it.
- Wrap the felt tape around the pipe and the drain hose, then put the pipe in the back space of the indoor unit.

4-7 DRAIN PIPING

- The drain hose should point downward for easy drain flow. (Fig. 1)
- Do not make drain piping as shown in Fig. 2 to 5.

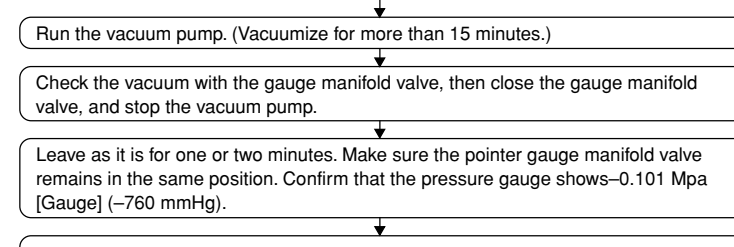

4-8 DRAIN PIPING

- If the drain hose provided with the indoor unit is too short, connect it with drain hose that should be provided at your site.
- If the extension drain hose has to pass through a room, be sure to wrap it with commercially sold insulation.

4-9 DRAIN PIPING

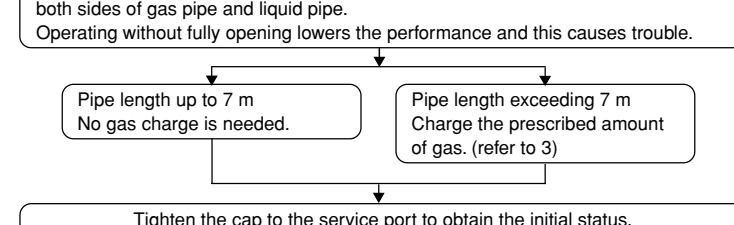

4-10 DRAIN PIPING

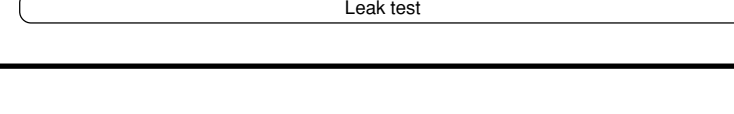

FOR REAR, RIGHT OR DOWNWARD PIPING

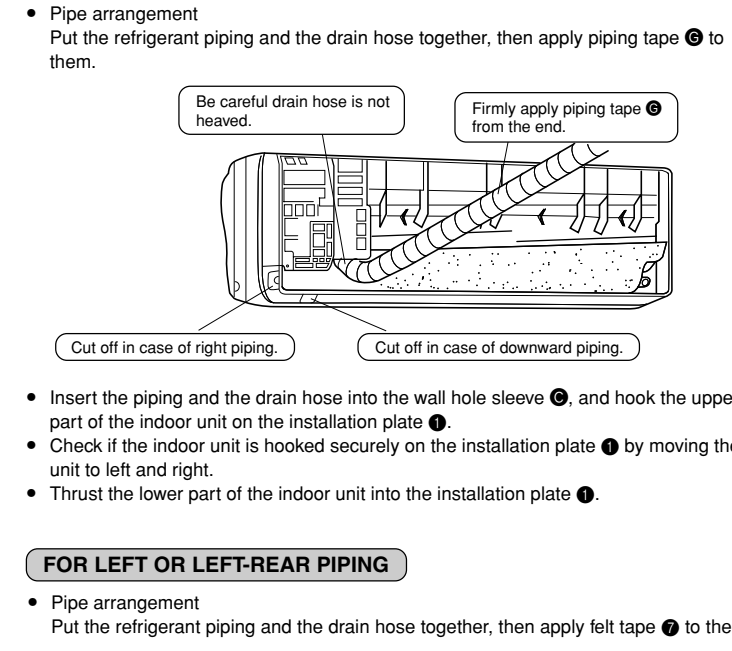

FOR LEFT OR LEFT-REAR PIPING

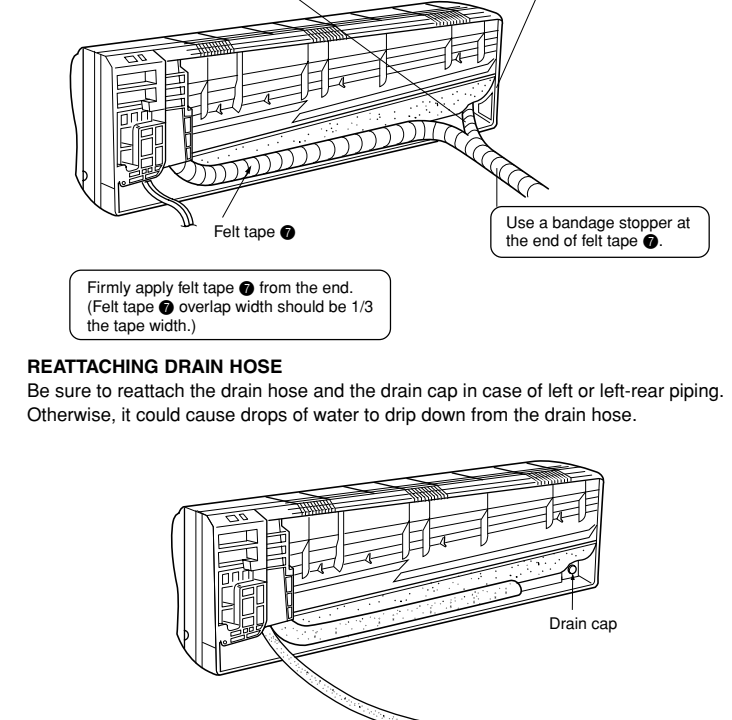

4-5 AUTO RESTART FUNCTION

- These models are equipped with an auto restart function. If you do not want to use this function, please consult the service representative because the setting of the unit needs to be changed.
- When the indoor unit is controlled with the remote controller, the operation mode, set temperature, and the fan speed are memorized by the indoor electronic control P.C. board. The auto restart function sets to work the moment the power has restarted after power failure, then, the unit will restart automatically. If the unit is operated in '1 FEEL...' or 'AUTO' mode before power failure, the operation mode (COOL, DRY or HEAT) is not stored in the memory. When the main power is turned on, the unit decides the operation mode by the initial room temperature at restart and starts operation again.

OPERATION

- ① If the main power has been cut, the operation settings remain.
- ② When three minutes have passed after power was restored, the unit will restart automatically according to the memory.

NOTES:

- The operation settings are memorized when 10 seconds have passed after the remote control was operated.
- If the main power is turned off or a power failure occurs while AUTO START/STOP timer is active, the timer setting is cancelled. As these models are equipped with an auto restart function, the air conditioner starts operating with timer cancelled at the same time that power is restored.
- If the unit has been off with the remote controller before power failure, the auto restart function does not work as the power button of the remote controller is off.
- To prevent breaker off due to the rush of starting current, systematize other home appliances not to turn on at the same time.

4-6 PIPE FORMING

- Flare the drain hose below the refrigerant piping.
- Make sure that the drain hose is not heaved or snaked.
- Do not pull the hose to apply the tape.
- When the drain hose passes the room, be sure to wrap insulation material (obtainable at a store) around it.
- Wrap the felt tape around the pipe and the drain hose, then put the pipe in the back space of the indoor unit.

4-7 DRAIN PIPING

- The drain hose should point downward for easy drain flow. (Fig. 1)
- Do not make drain piping as shown in Fig. 2 to 5.

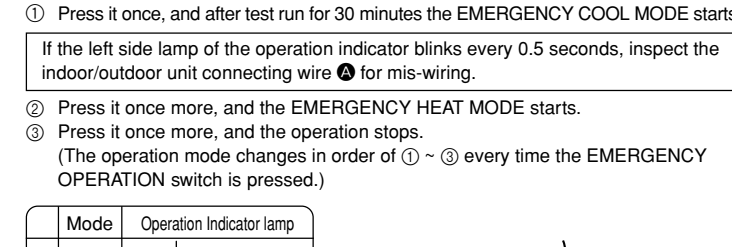

4-8 DRAIN PIPING

- If the drain hose provided with the indoor unit is too short, connect it with drain hose that should be provided at your site.
- If the extension drain hose has to pass through a room, be sure to wrap it with commercially sold insulation.

4-9 DRAIN PIPING

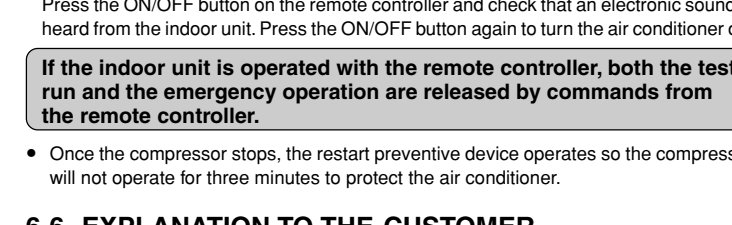

4-10 DRAIN PIPING

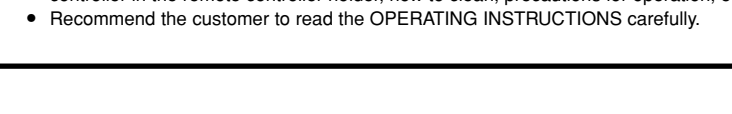

7. FOR MOVEMENT AND MAINTENANCE

7-1 REMOVING AND REINSTALLING THE FRONT PANEL

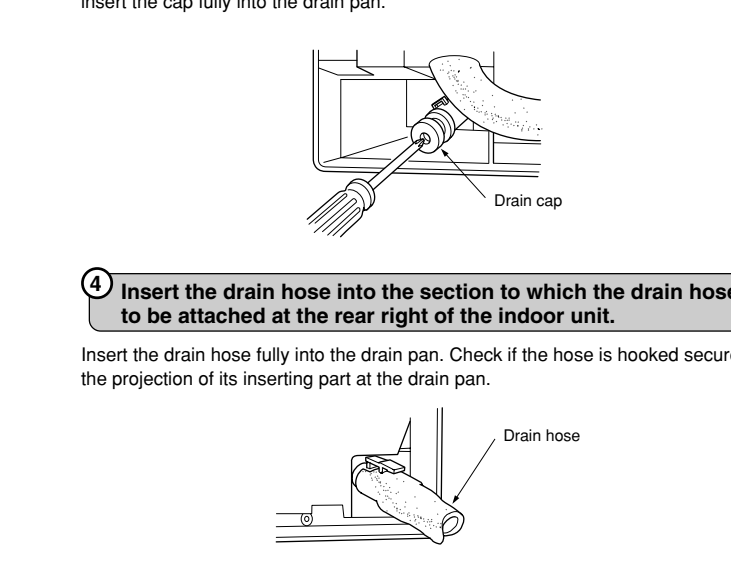

7-2 REMOVING THE INDOOR UNIT

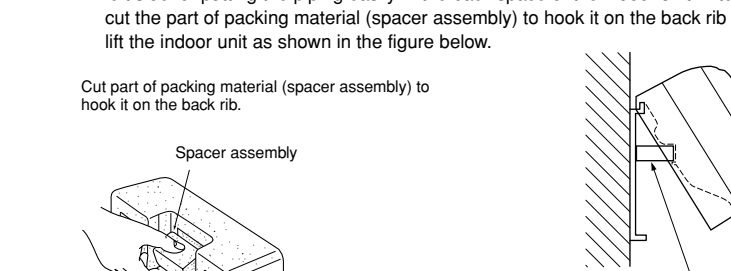

7-3 GAS CHARGE

- Connect gas cylinder to the service port of stop valve (3-way).
- Execute air purge of the pipe (or hose) coming from refrigerant gas cylinder.
- Refill the specified amount of the refrigerant, while operating the air conditioner for cooling.

7-4 REFRIGERANT CHARGE

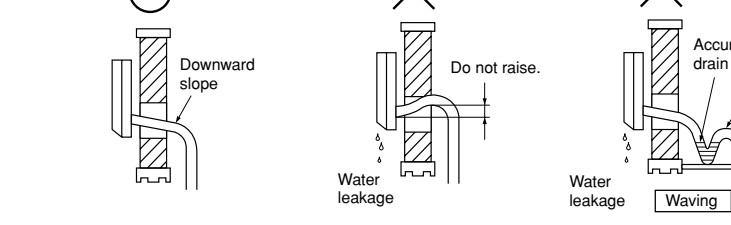

7-5 REFRIGERANT CHARGE

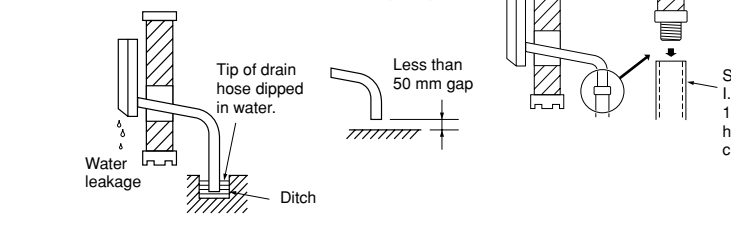

7-6 REFRIGERANT CHARGE

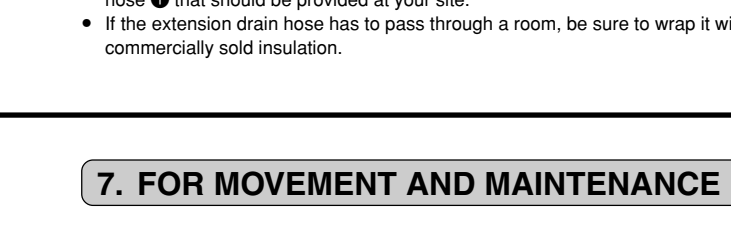

7-7 REFRIGERANT CHARGE

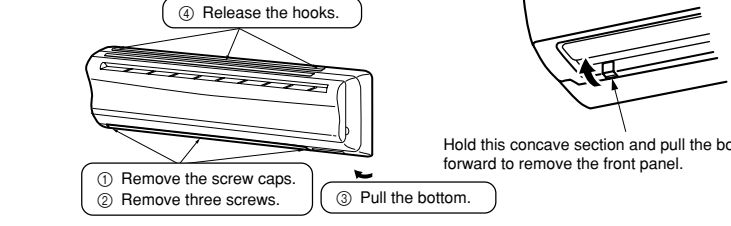

7-8 REFRIGERANT CHARGE

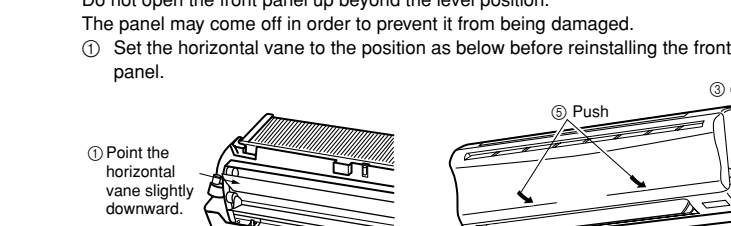

7-9 REFRIGERANT CHARGE

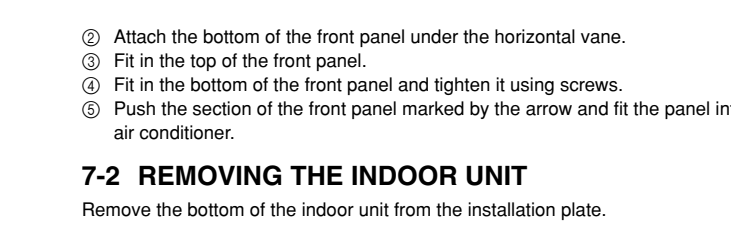

7-10 REFRIGERANT CHARGE

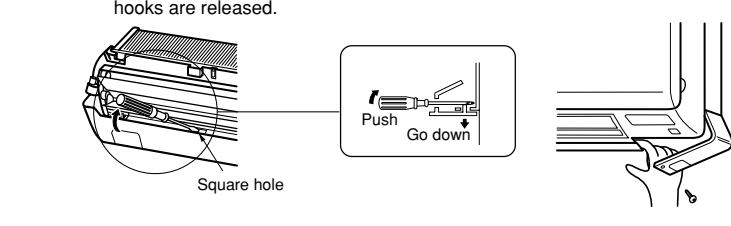

7-11 REFRIGERANT CHARGE



7-12 REFRIGERANT CHARGE



7-13 REFRIGERANT CHARGE

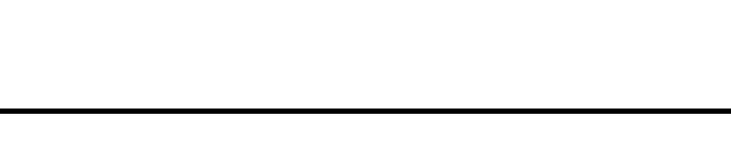

5. OUTDOOR UNIT INSTALLATION

INDOOR/OUTDOOR UNIT CONNECTING WIRE CONNECTION AND OUTDOOR POWER SUPPLY CORD CONNECTION

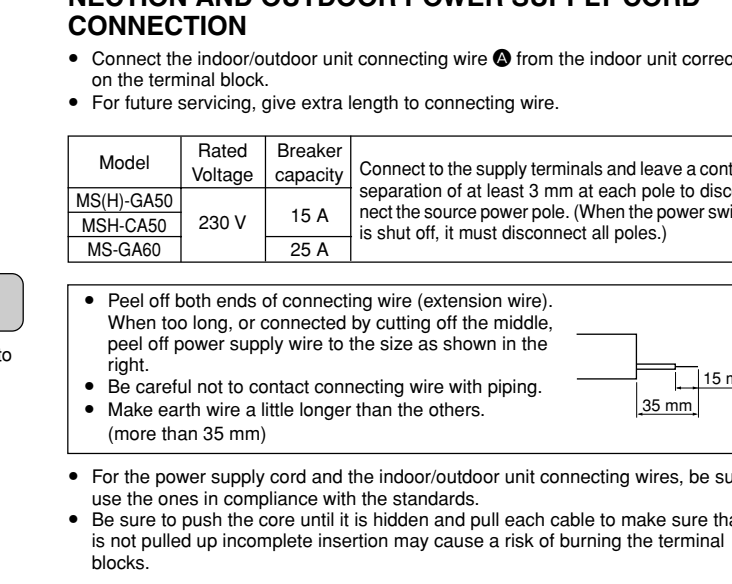

INDOOR UNIT INSTALLATION

- Insert the drain hose into the wall hole sleeve and hook the upper part of indoor unit on the installation plate.
- Then, move the unit to the very edge of the left side for putting the piping easily in the back space of the indoor unit. After that, cut the part of packing material (spacer assembly) to hook it on the back rail and lift the indoor unit as shown in the figure below.

INDOOR UNIT INSTALLATION

- Insert the drain hose into the wall hole sleeve and hook the upper part of indoor unit on the installation plate.
- Then, move the unit to the very edge of the left side for putting the piping easily in the back space of the indoor unit. After that, cut the part of packing material (spacer assembly) to hook it on the back rail and lift the indoor unit as shown in the figure below.

INDOOR UNIT INSTALLATION

- Insert the drain hose into the wall hole sleeve and hook the upper part of indoor unit on the installation plate.
- Then, move the unit to the very edge of the left side for putting the piping easily in the back space of the indoor unit. After that, cut the part of packing material (spacer assembly) to hook it on the back rail and lift the indoor unit as shown in the figure below.

INDOOR UNIT INSTALLATION

- Insert the drain hose into the wall hole sleeve and hook the upper part of indoor unit on the installation plate.
- Then, move the unit to the very edge of the left side for putting the piping easily in the back space of the indoor unit. After that, cut the part of packing material (spacer assembly) to hook it on the back rail and lift the indoor unit as shown in the figure below.

INDOOR UNIT INSTALLATION