

AIR VOLUME CONTROL TECHNICAL MANUAL

Models

PEAD-RP60JA(L)
PEAD-RP71JA(L)
PEAD-RP100JA(L)
PEAD-RP125JA(L)
PEAD-RP140JA(L)

PEFY-P63VMA(L)-E
PEFY-P71VMA(L)-E
PEFY-P80VMA(L)-E
PEFY-P100VMA(L)-E
PEFY-P125VMA(L)-E
PEFY-P140VMA(L)-E

CONTENTS

1. Air volume control by analog input.....	2
2. Air volume control by contact input.....	5
3. Fan characteristic curves.....	7
4. Restrictions.....	17
5. Wiring	18
6. Function settings.....	20

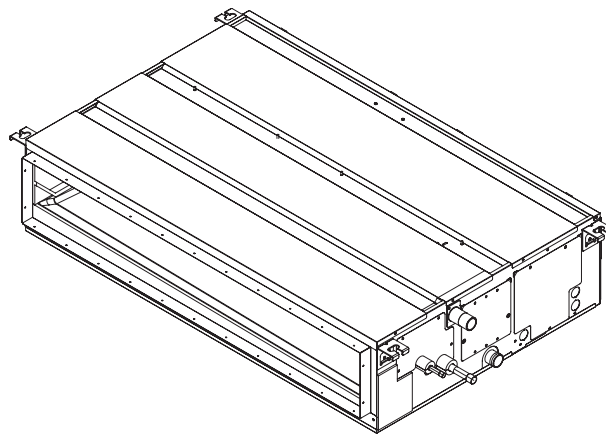

Mr. SLIM™
CITY MULTI

Air volume control technical manual

Indoor unit air volume can be controlled with a opening-closing of a damper by either an analog input (CN2A) or a contact input (CN105) to the air conditioning unit.

With the PEAD series, it is possible to cut energy consumption by controlling not only the air volume but also the compressor capacity.

■Corresponding model

Air volume can be controlled with the following models.

- (1) PEAD-RP60,71,100,125,140JA(L)
- (2) PEFY-P63,71,80,100,125,140VMA(L)-E

NOTE:

Air volume control with analog input 0-10V is not available with the following models.

- (a) PEAD-RP35,50JA(L)
- (b) PEFY-P20,25,32,40,50VMA(L)-E

■System configuration

PEAD

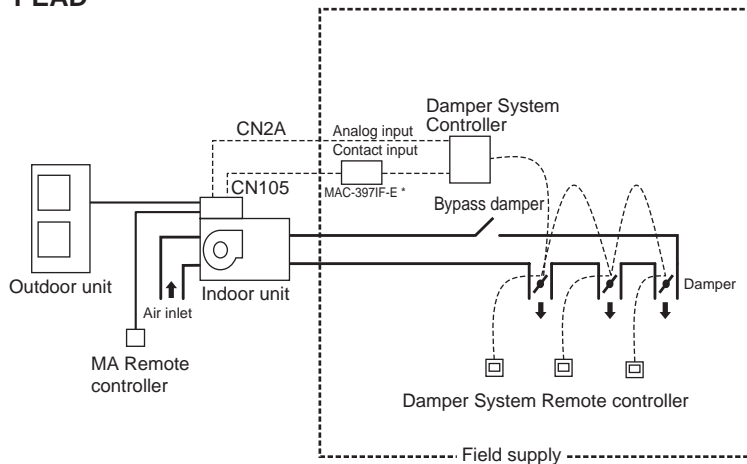

Supply connectors to CN2A and CN105 on site. (Refer to 5)

* MAC-397IF-E:MA & Contact terminal interface (optional)

PEFY

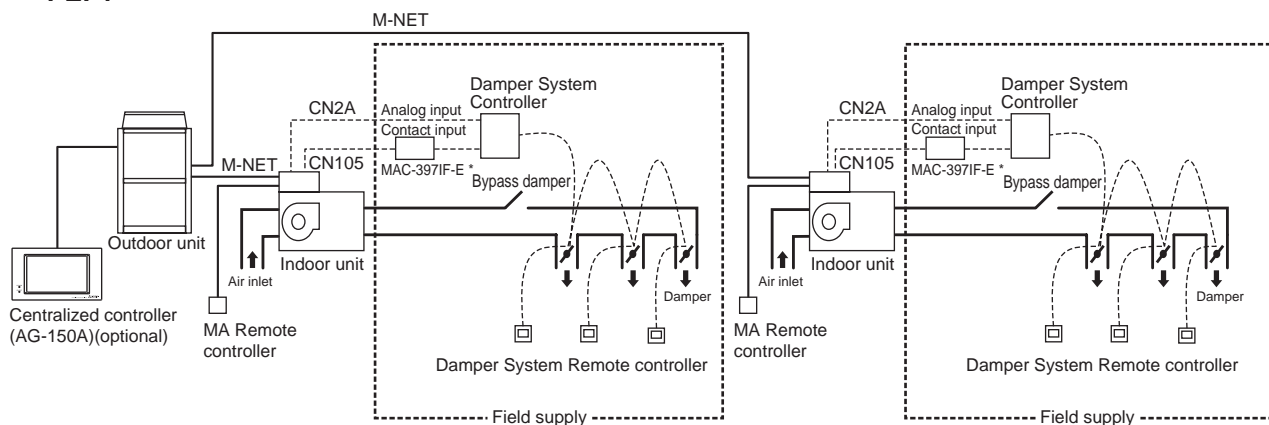

Supply connectors to CN2A and CN105 on site.

* MAC-397IF-E:MA & Contact terminal interface (optional)

1. Air volume control by analog input

1-1. Air volume control

Indoor air volume can be controlled in 10 different stages from V1 to V10 with analog input 0-10V from the damper system controller supplied on site.

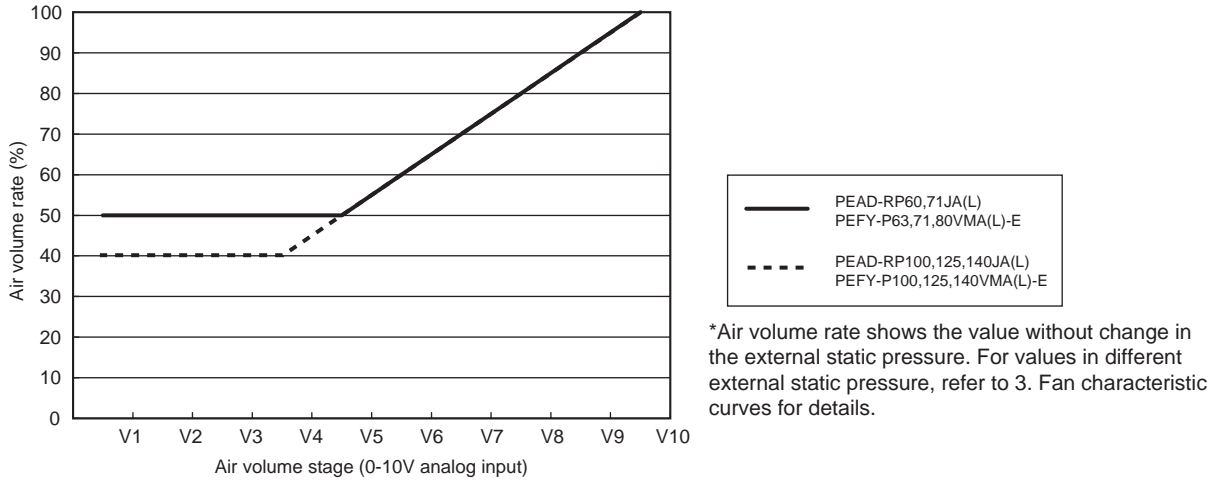

1-2. Outdoor unit capacity control

With the PEAD series, compressor capacity is controlled in accordance with air volume level in 10 stages from V1 to V10.

With the PEFY series, compressor capacity will not be controlled because numbers of indoor units are connected. However, it is possible to reduce energy consumption with a change in the air volume leading to compressor capacity control due to a change in condensing temperature.

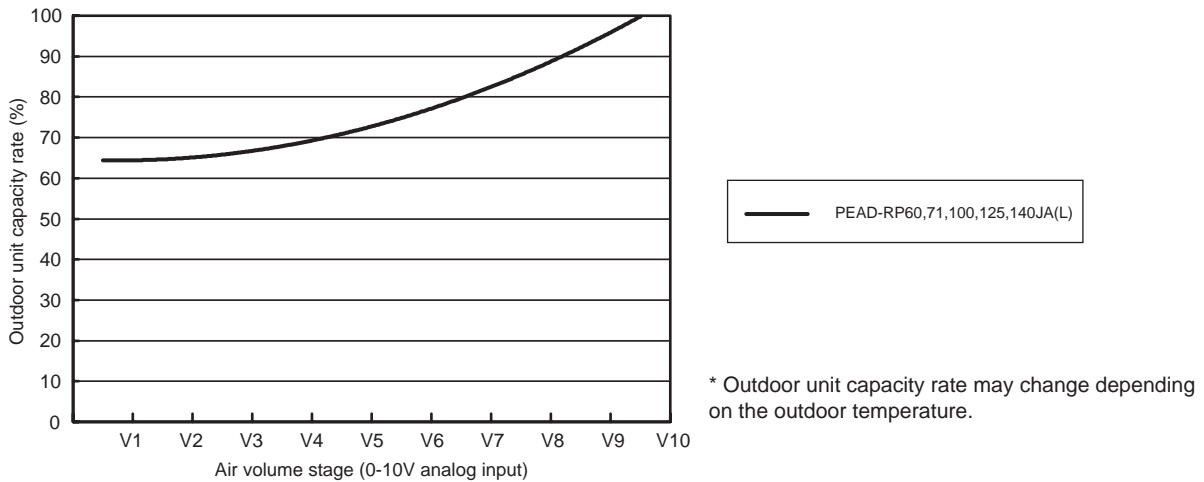

1-3. Analog input of voltage

With analog input of voltage, fan rotation and air volume in 10 stages from V1 to V10 can be controlled.

Air volume stages	Analog input voltage(V)	Air volume standard setting (Damper System OFF) *1
V1	0.0~1.5	-
V2	1.0~2.5	
V3	2.0~3.5	
V4	3.0~4.5	
V5	4.0~5.5	
V6	5.0~6.5	
V7	6.0~7.5	Low
V8	7.0~8.5	Middle
V9	8.0~9.5	High
V10	9.0~10.0	

NOTE:

*1 In case of PEAD-RP JA(L) Dip SW 1-1 OFF, PEFY-P VMA(L)-E Dip SW 3-6 OFF, refer to 6-1.

■Differentials of air volume stages V1 to V10

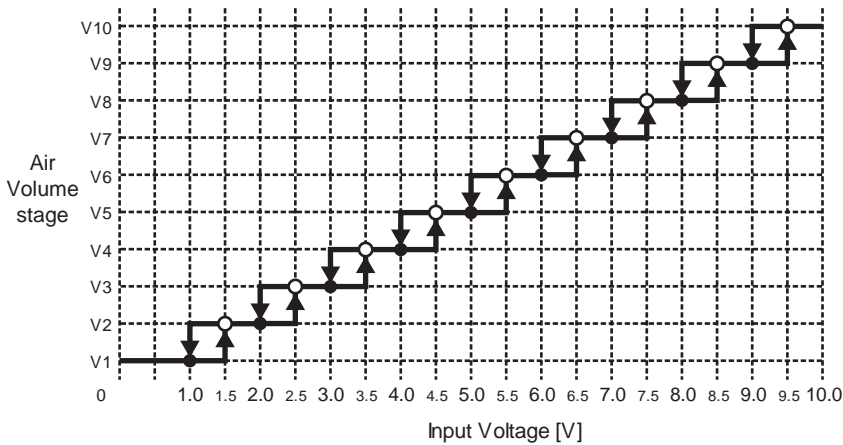

■Example of analog input of voltage

When analog input changes ①7.2V→②7.5V→③7.2V→④7.0V→⑤6.3V→⑥6.0V→⑦6.3V→⑧6.5V,

air volume stages are decided as ①V7→②V8→③V8→④V7→⑤V7→⑥V6→⑦V6→⑧V7.

See drawing below for details.

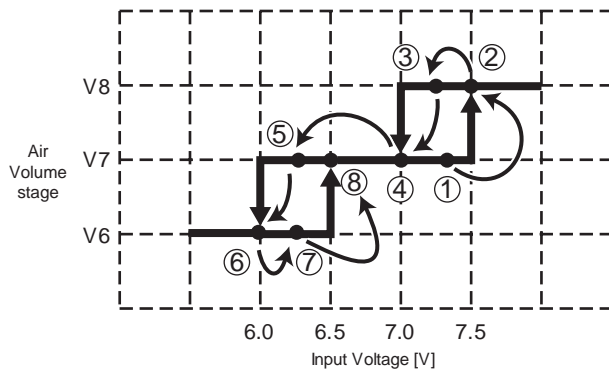

1-4. Example of air volume control 1

Air volume can be selected in the following order.

■Condition:

1. R1- R4 indicates the air outlet of each indoor unit.
2. R4 fully open at all times.
3. Air volume designed as R1: 5m³/min, R2: 5m³/min, R3: 7m³/min, R4:17m³/min.
4. Rated air volume measured when R1 - R3 is fully open. (External static pressure set as 100Pa)

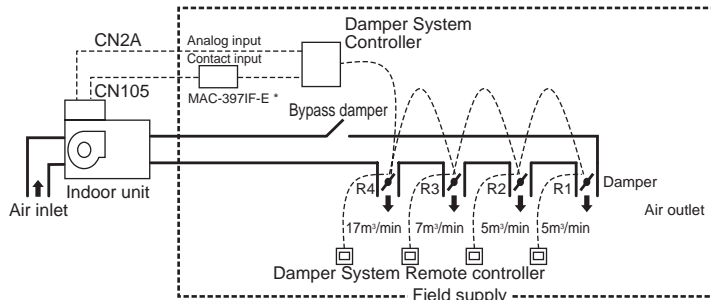

[Fig.1-4-1] Example of duct system

■Selecting air volume stage V1~V10

Depending on the damper opening pattern R1-R3, patterns ①~⑧ as in the below chart is available. The air volume stage is selected from the fan characteristic curve. (Refer to [Fig. 1-4-3])

Choose the pattern closest to the required air volume and which the diagram exceeds.

Duct pressure drop depends on the site conditions. Shown here are temporarily numbers in case of external static pressure 100Pa.

	Air Outlet	R1	R2	R3	R4	Total Air volume [m ³ /min]	Selected Stage
	Air Volume [m ³ /min]	5	5	7	17	34	-
Air volume pattern	①	Open	Open	Open	Open	34	V10
	②	Close	Open	Open	Open	29	V9
	③	Open	Close	Open	Open	29	V9
	④	Close	Close	Open	Open	24	V7
	⑤	Open	Open	Close	Open	27	V8
	⑥	Close	Open	Close	Open	22	V7
	⑦	Open	Close	Close	Open	22	V7
	⑧	Close	Close	Close	Open	17	V5

[Fig.1-4-2] Air volume pattern

* ①~⑧ in the below diagram [Fig.1-4-3] indicates the air volume pattern ①~⑧ shown in this chart [Fig. 1-4-2]

PEAD-RP100JA(L)

(External static pressure 100Pa) 220-240V 50/60Hz

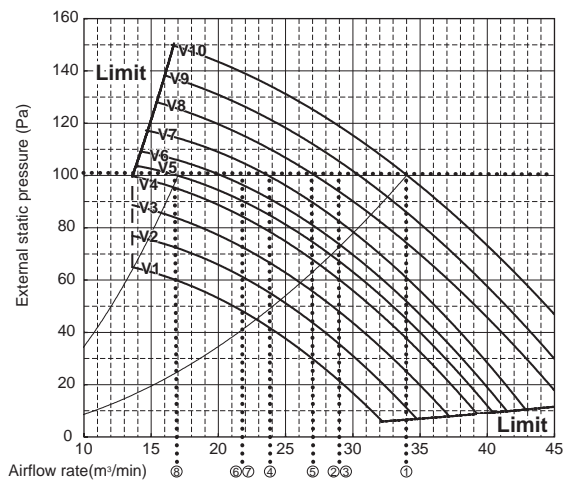

[Fig.1-4-3] Duct damper open/close

■Example of system flow

The following explains the system flow for duct damper open/close pattern ①~⑥ shown in [Fig.1-4-3].

Condition:

Voltage decrease from 10.0V to 3.7V when duct damper changes from full-open to R1,R3 close.

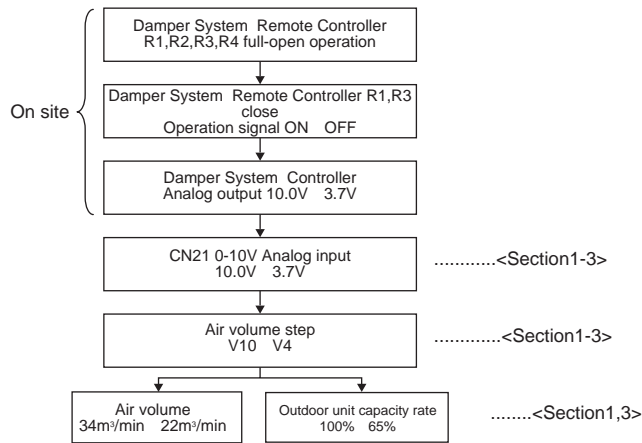

2. Air volume control by contact input

2-1. Function control by MAC-397IF-E (CN105)

Following functions can be controlled from damper system controller by using MAC-397IF-E.

1. ON/OFF
2. Cooling/ Heating/ Fan mode
3. Air volume rate change (Hi-Mid-Lo)

PRECAUTION:

Multistage air volume control is not available via MAC-397IF-E.

In order to control multistage air volume and compressor capacity (PEAD series), use 0-10V analog input (CN2A).

No.	Function change from Damper system controller	MAC-397IF-E use	Indoor unit control board switch setting	
			PEAD	PEFY
			SW1-1	SW3-6
①	ON / OFF	○	OFF	
②	Cooling/ Heating/ Fan	○	OFF	
③	Air volume rate change (Hi-Mid-Lo)	○	OFF	

NOTE*1 In order to change functions ①~③ from MAC-397IF-E, contact input from damper system controller is required. Only one of the functions ①~③ is available one at a time because setting is made by switching DIP-SW of MAC-397IF-E. Refer to the MAC-397IF-E manual for DIP-SW setting and wiring.

*2 When not using MAC-397IF-E, ①~③ functions only available from MA remote controller.

*3 Combination of function ③ and analog input is not available.

2-2. Example of air volume control by contact input and analog input

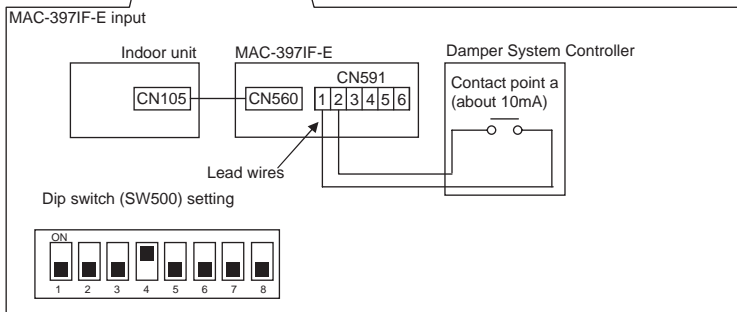
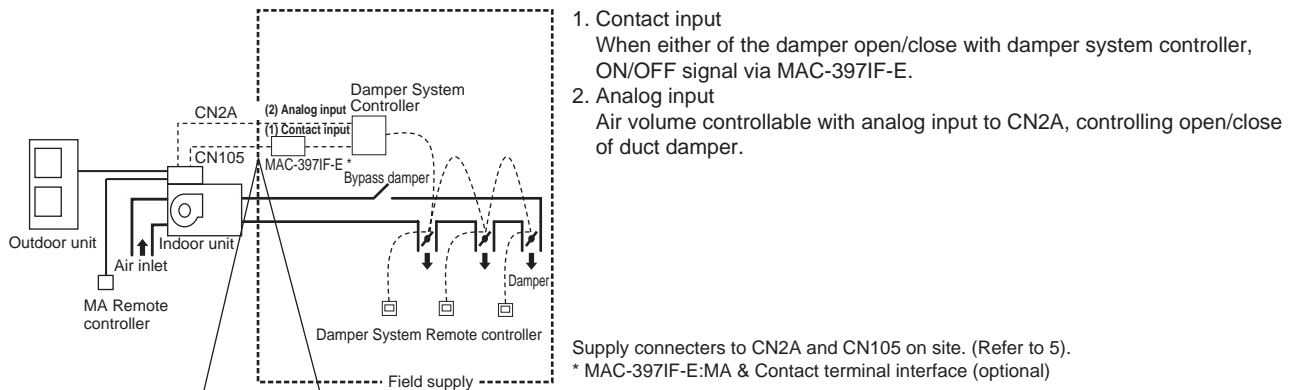

Refer to the MAC-397IF-E manual for DIP-SW setting and wiring.

* It is possible to directly command CN105 without MAC-397IF-E with serial communication. For further details, contact your nearest distributor.

2-3. Example of air volume control with fixed static pressure

This example shows how to keep duct static pressure at a constant level with analog input.

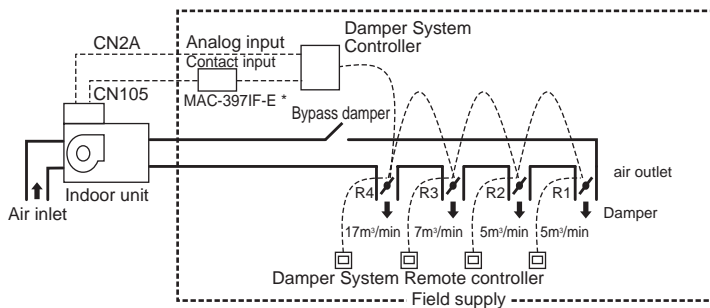

Check air volume at each air outlet when R1-R4 is full open and set static pressure as target value. Then, analog input to keep the static pressure at this target value even when either of the damper closes.

With MAC-397IF-E as in section 2-2, it is also possible to stop the indoor unit when all duct damper closes.

*Refer to the 1-3 for air volume differentials to prevent hunting.

3. Fan characteristic curves

With an analog input of 0-10V, indoor air volume can be controlled in 10 steps from V1 to V10.

PEAD-RP60JA(L)

(External static pressure 35Pa) 220-240V 50/60Hz

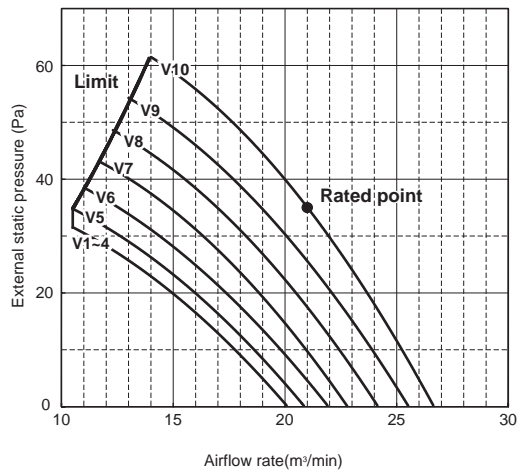

PEAD-RP60JA(L)

(External static pressure 100Pa) 220-240V 50/60Hz

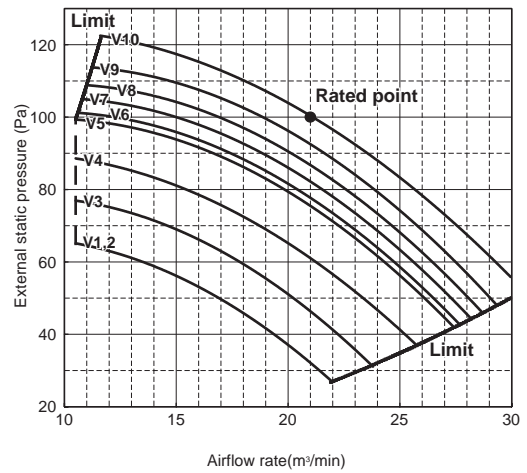

PEAD-RP60JA(L)

(External static pressure 50Pa) 220-240V 50/60Hz

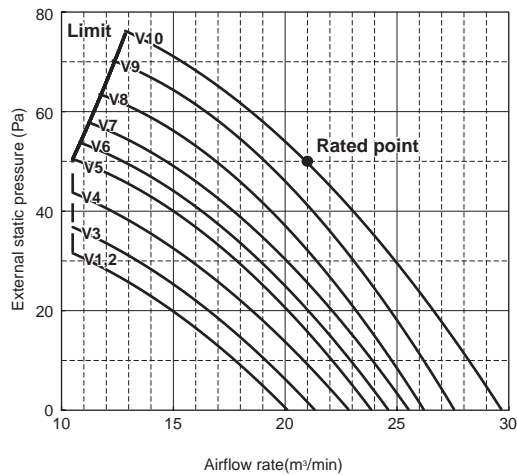

PEAD-RP60JA(L)

(External static pressure 150Pa) 220-240V 50/60Hz

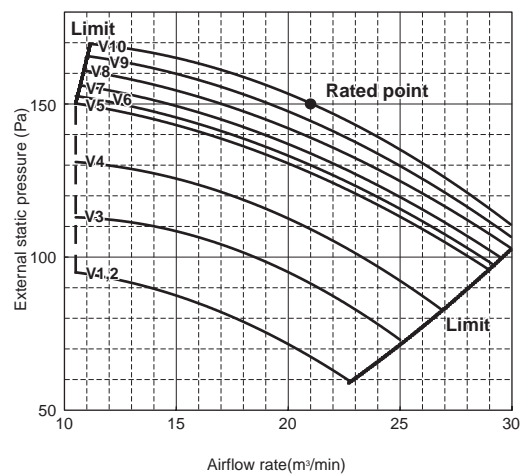

PEAD-RP60JA(L)

(External static pressure 70Pa) 220-240V 50/60Hz

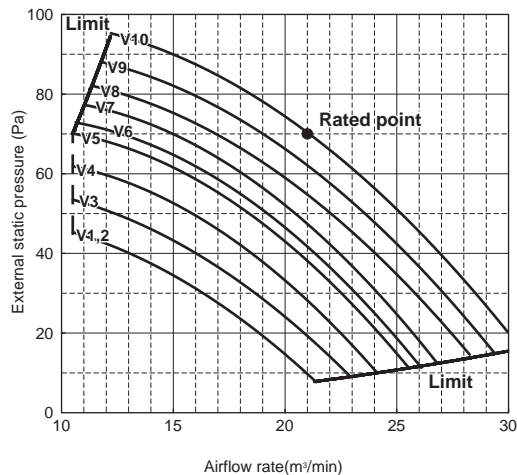

PEAD-RP71JA(L)

(External static pressure 35Pa) 220-240V 50/60Hz

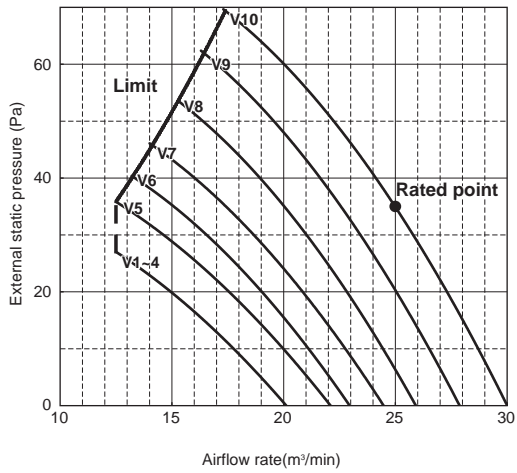

PEAD-RP71JA(L)

(External static pressure 100Pa) 220-240V 50/60Hz

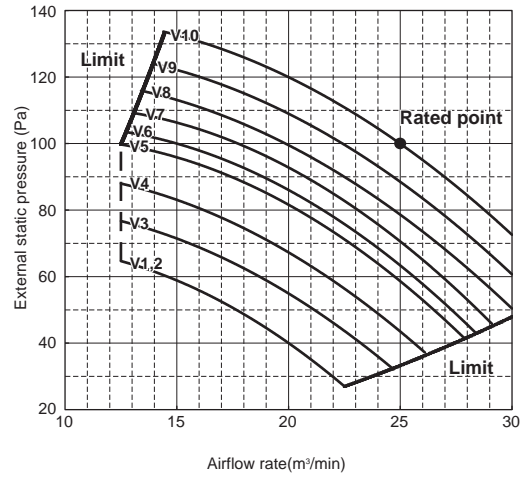

PEAD-RP71JA(L)

(External static pressure 50Pa) 220-240V 50/60Hz

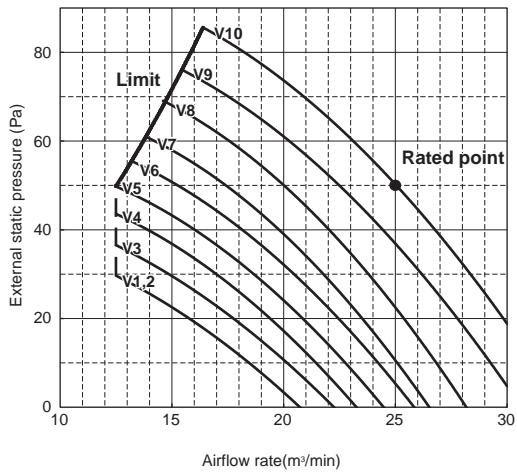

PEAD-RP71JA(L)

(External static pressure 150Pa) 220-240V 50/60Hz

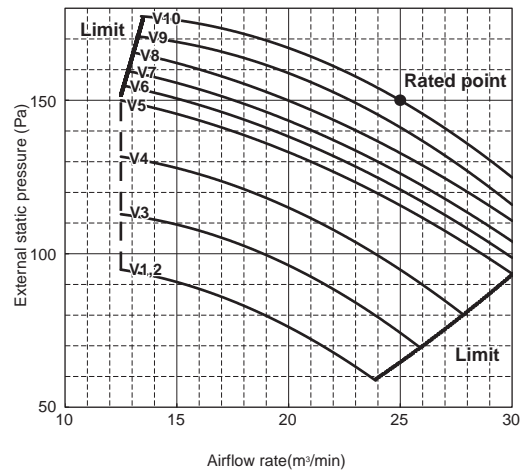

PEAD-RP71JA(L)

(External static pressure 70Pa) 220-240V 50/60Hz

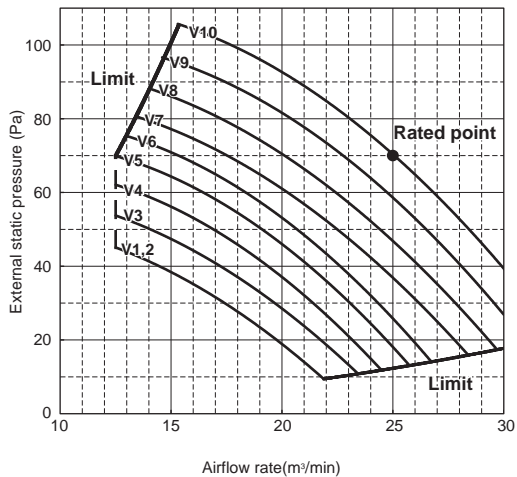

PEAD-RP100JA(L)

(External static pressure 35Pa) 220-240V 50/60Hz

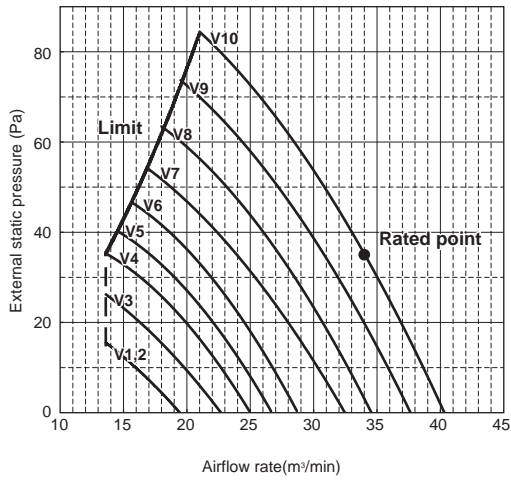

PEAD-RP100JA(L)

(External static pressure 100Pa) 220-240V 50/60Hz

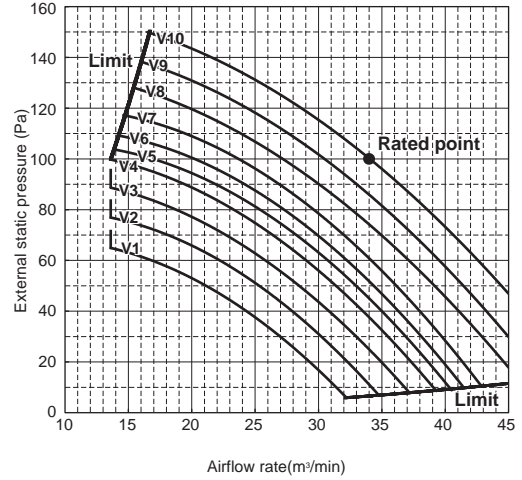

PEAD-RP100JA(L)

(External static pressure 50Pa) 220-240V 50/60Hz

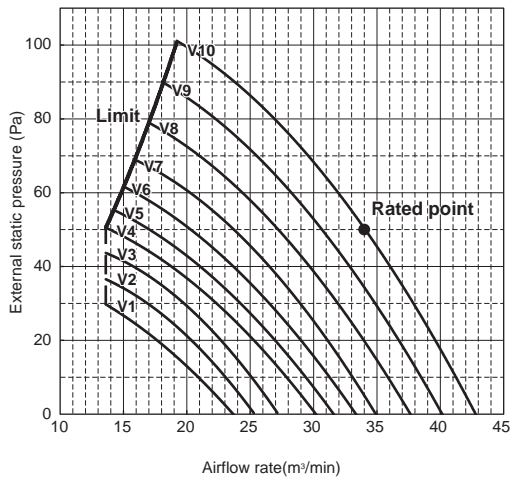

PEAD-RP100JA(L)

(External static pressure 150Pa) 220-240V 50/60Hz

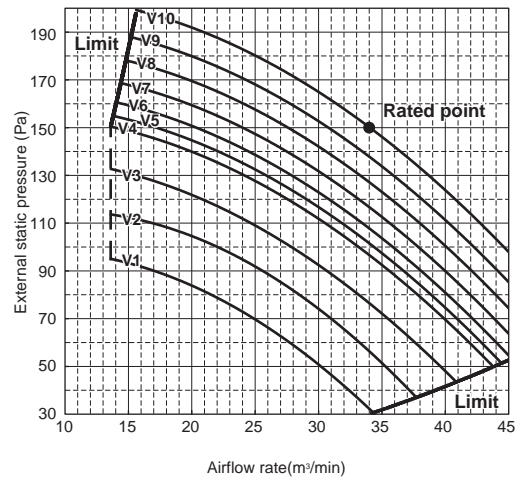

PEAD-RP100JA(L)

(External static pressure 70Pa) 220-240V 50/60Hz

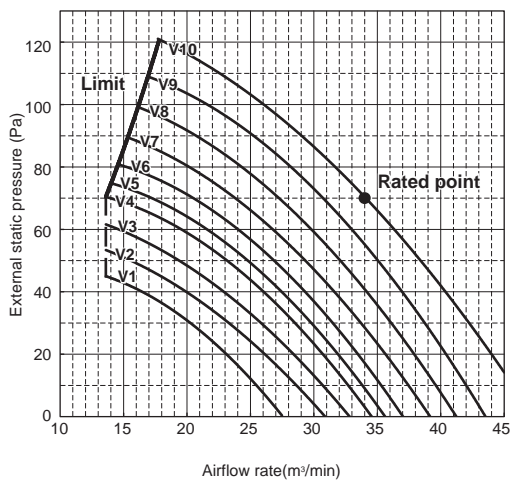

PEAD-RP125JA(L)

(External static pressure 35Pa) 220-240V 50/60Hz

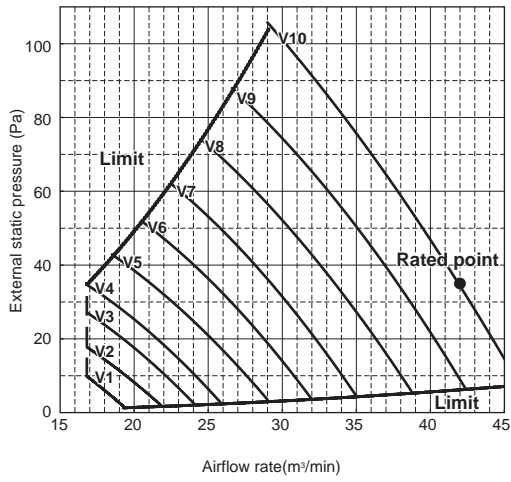

PEAD-RP125JA(L)

(External static pressure 100Pa) 220-240V 50/60Hz

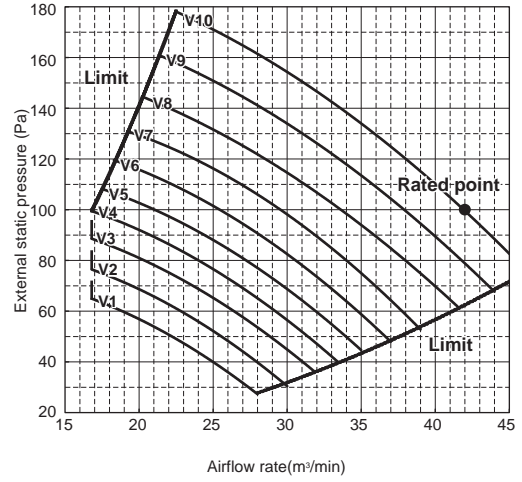

PEAD-RP125JA(L)

(External static pressure 50Pa) 220-240V 50/60Hz

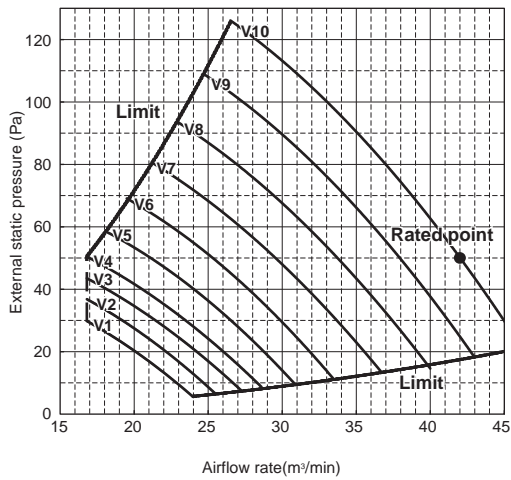

PEAD-RP125JA(L)

(External static pressure 150Pa) 220-240V 50/60Hz

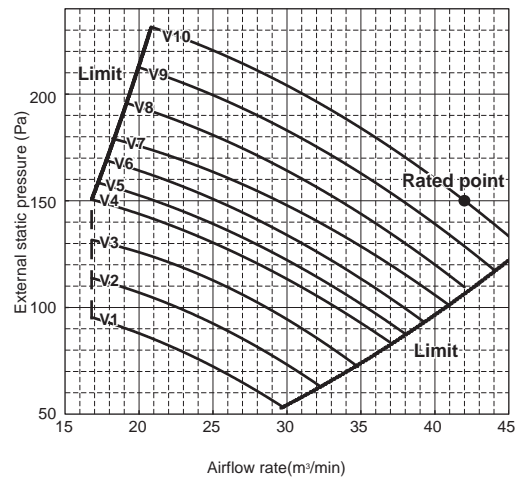

PEAD-RP125JA(L)

(External static pressure 70Pa) 220-240V 50/60Hz

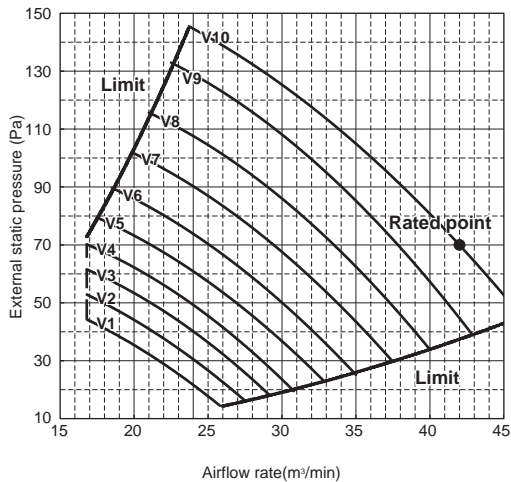

PEAD-RP140JA(L)

(External static pressure 35Pa) 220-240V 50/60Hz

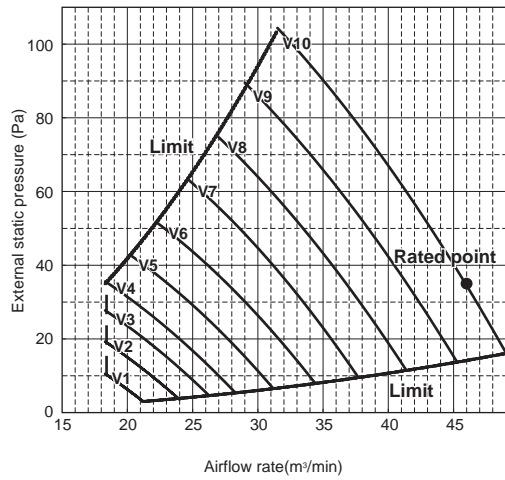

PEAD-RP140JA(L)

(External static pressure 100Pa) 220-240V 50/60Hz

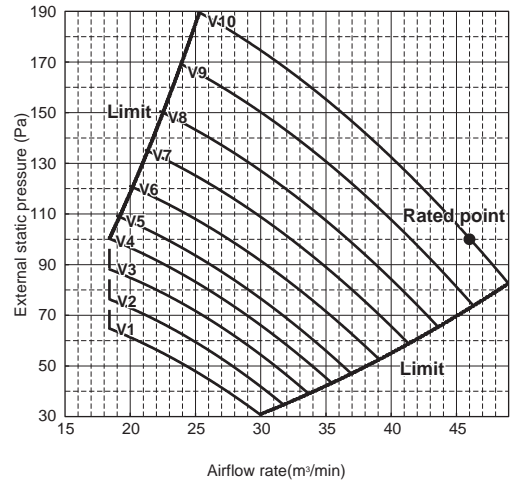

PEAD-RP140JA(L) VAV

(External static pressure 50Pa) 220-240V 50/60Hz

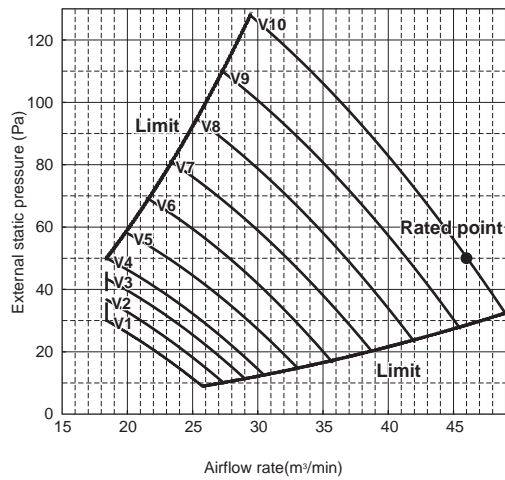

PEAD-RP140JA(L)

(External static pressure 150Pa) 220-240V 50/60Hz

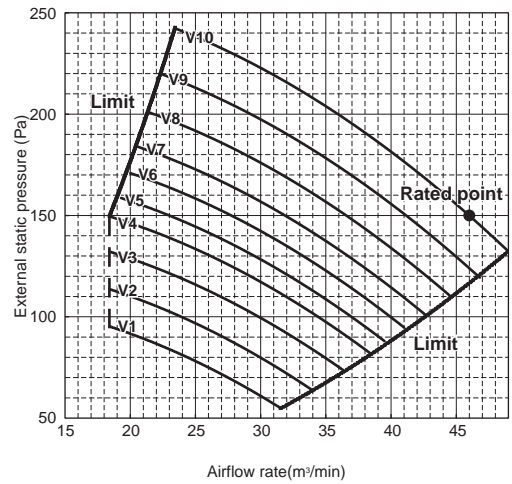

PEAD-RP140JA(L)

(External static pressure 70Pa) 220-240V 50/60Hz

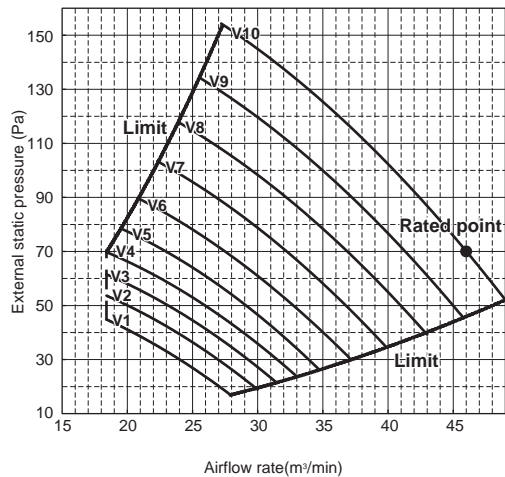

PEFY-P63VMA(L)-E

(External static pressure 35Pa) 220-240V 50/60Hz

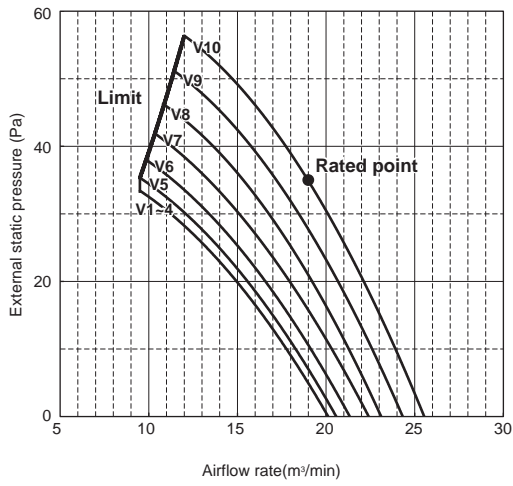

PEFY-P63VMA(L)-E

(External static pressure 100Pa) 220-240V 50/60Hz

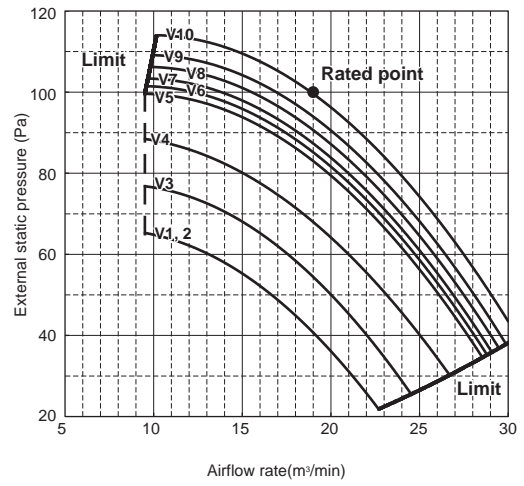

PEFY-P63VMA(L)-E

(External static pressure 50Pa) 220-240V 50/60Hz

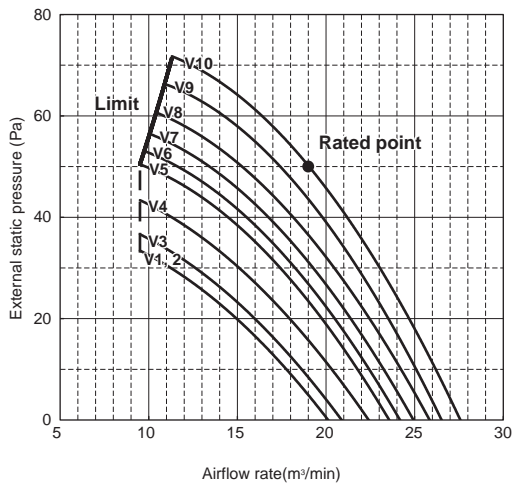

PEFY-P63VMA(L)-E

(External static pressure 150Pa) 220-240V 50/60Hz

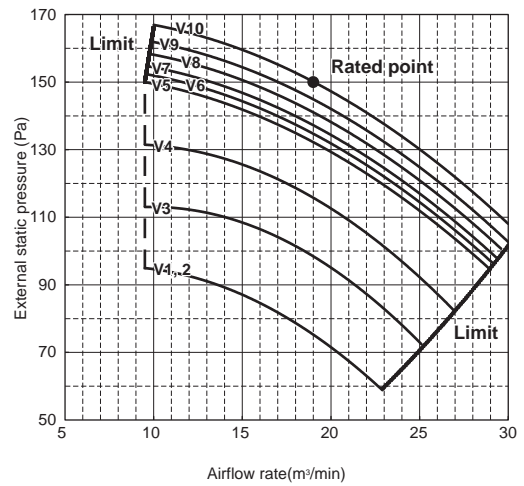

PEFY-P63VMA(L)-E

(External static pressure 70Pa) 220-240V 50/60Hz

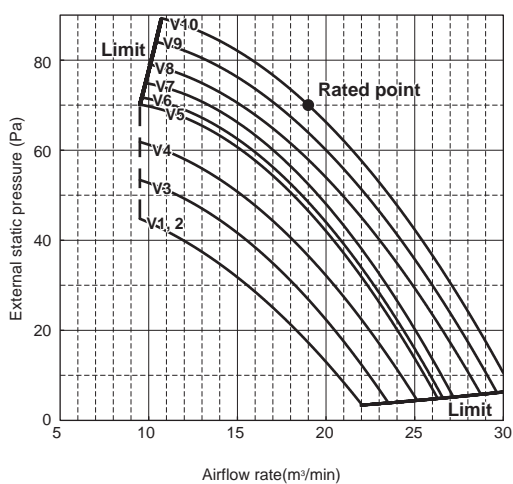

PEFY-P71,80VMA(L)-E

(External static pressure 35Pa) 220-240V 50/60Hz

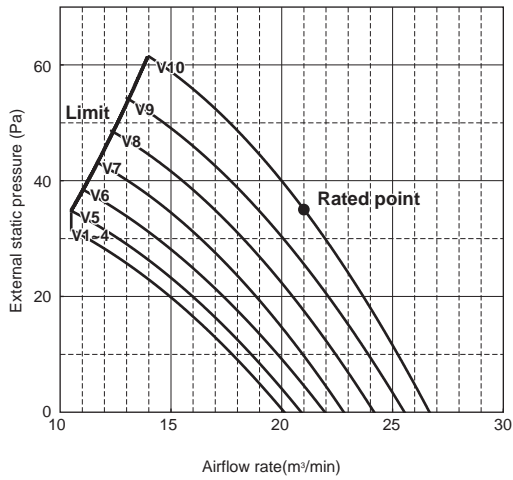

PEFY-P71,80VMA(L)-E

(External static pressure 100Pa) 220-240V 50/60Hz

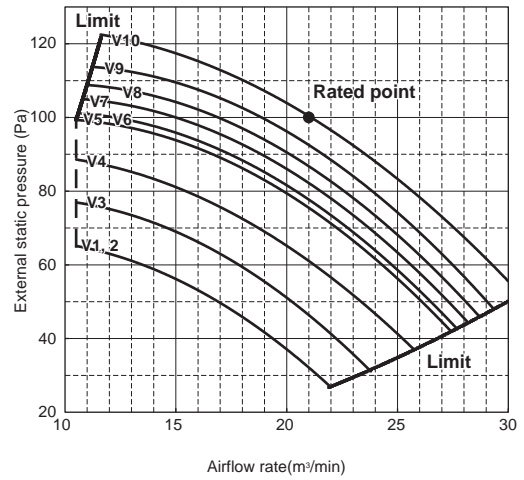

PEFY-P71,80VMA(L)-E

(External static pressure 50Pa) 220-240V 50/60Hz

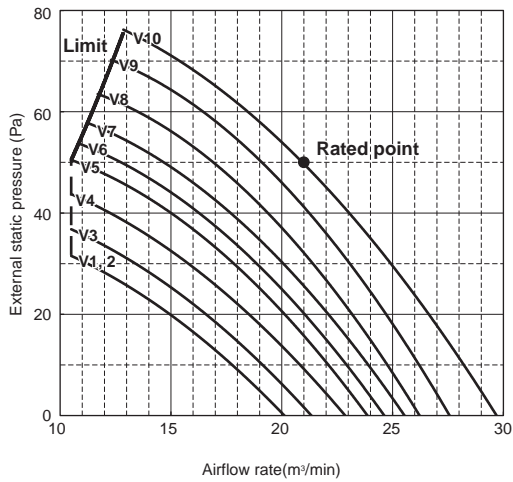

PEFY-P71,80VMA(L)-E

(External static pressure 150Pa) 220-240V 50/60Hz

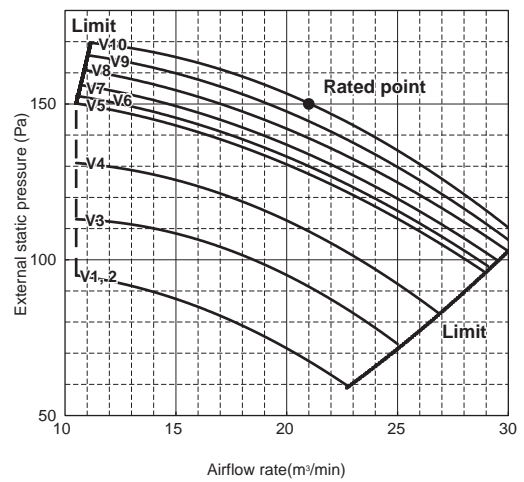

PEFY-P71,80VMA(L)-E

(External static pressure 70Pa) 220-240V 50/60Hz

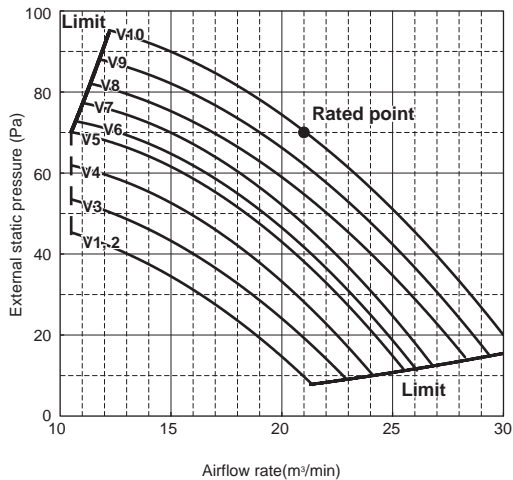

PEFY-P100VMA(L)-E

(External static pressure 35Pa) 220-240V 50/60Hz

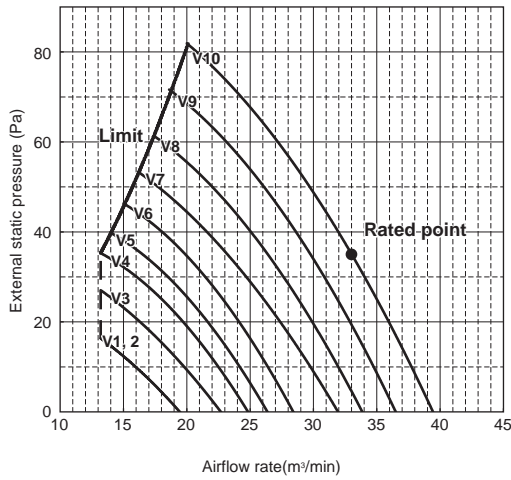

PEFY-P100VMA(L)-E

(External static pressure 100Pa) 220-240V 50/60Hz

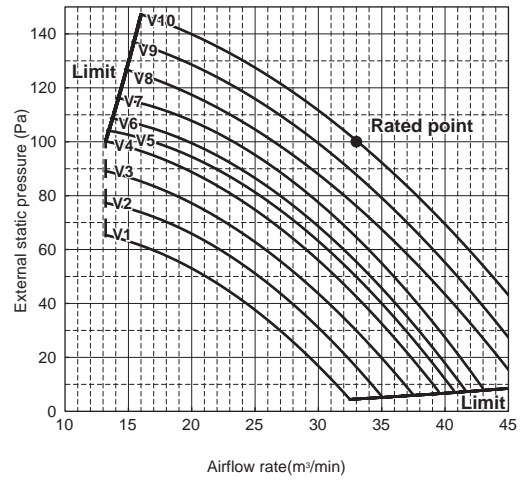

PEFY-P100VMA(L)-E

(External static pressure 50Pa) 220-240V 50/60Hz

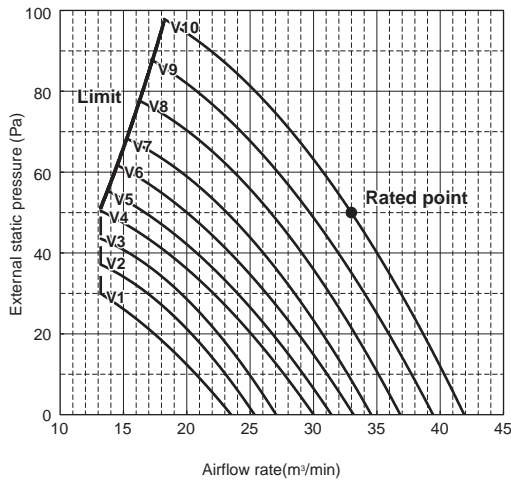

PEFY-P100VMA(L)-E

(External static pressure 150Pa) 220-240V 50/60Hz

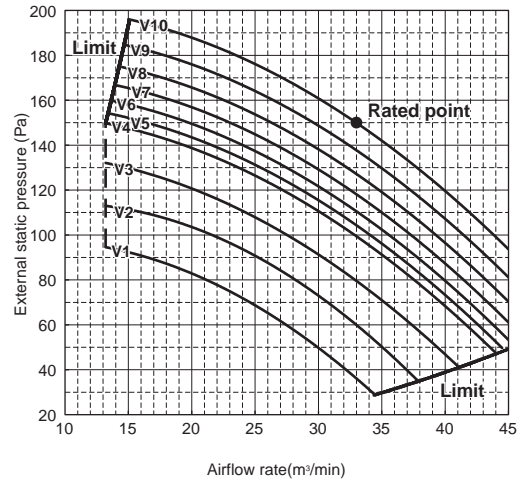

PEFY-P100VMA(L)-E

(External static pressure 70Pa) 220-240V 50/60Hz

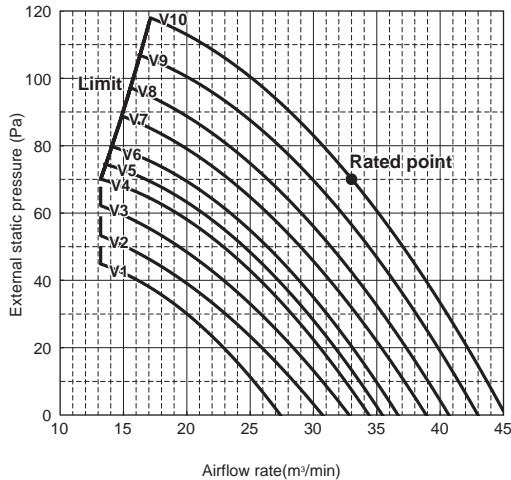

PEFY-P125VMA(L)-E

(External static pressure 35Pa) 220-240V 50/60Hz

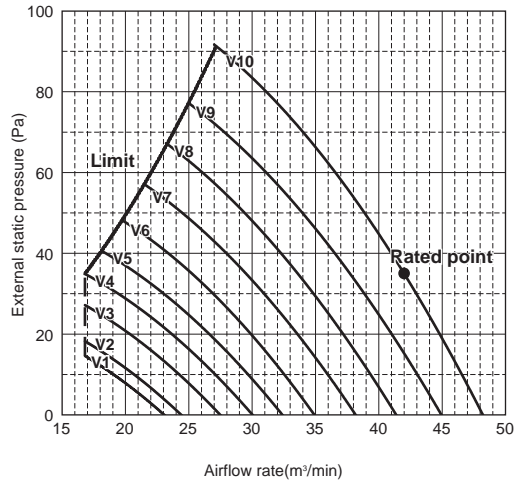

PEFY-P125VMA(L)-E

(External static pressure 100Pa) 220-240V 50/60Hz

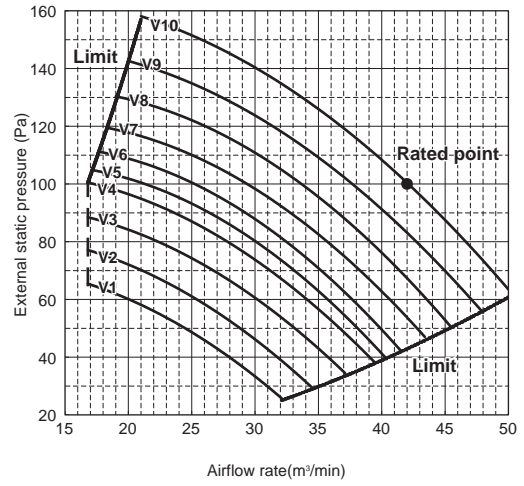

PEFY-P125VMA(L)-E

(External static pressure 50Pa) 220-240V 50/60Hz

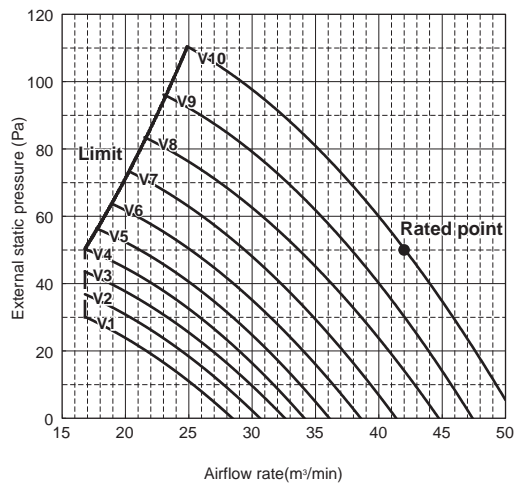

PEFY-P125VMA(L)-E

(External static pressure 150Pa) 220-240V 50/60Hz

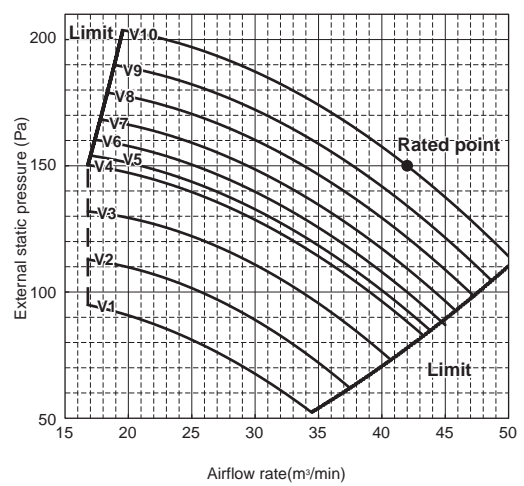

PEFY-P125VMA(L)-E

(External static pressure 70Pa) 220-240V 50/60Hz

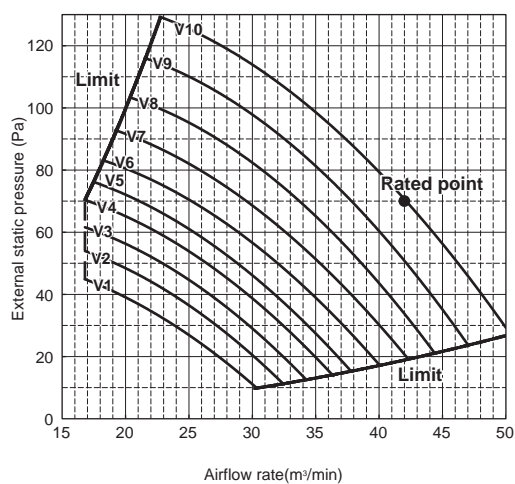

PEFY-P140VMA(L)-E

(External static pressure 35Pa) 220-240V 50/60Hz

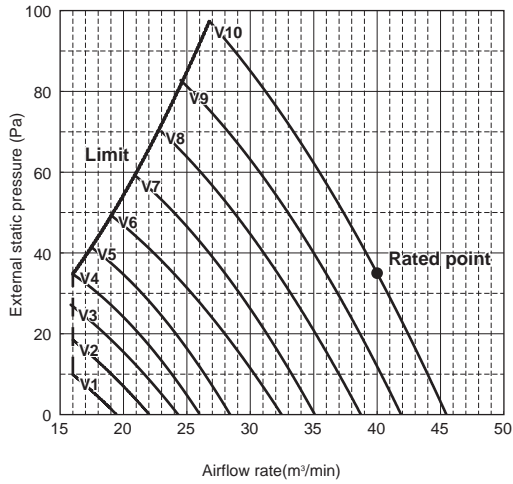

PEFY-P140VMA(L)-E

(External static pressure 100Pa) 220-240V 50/60Hz

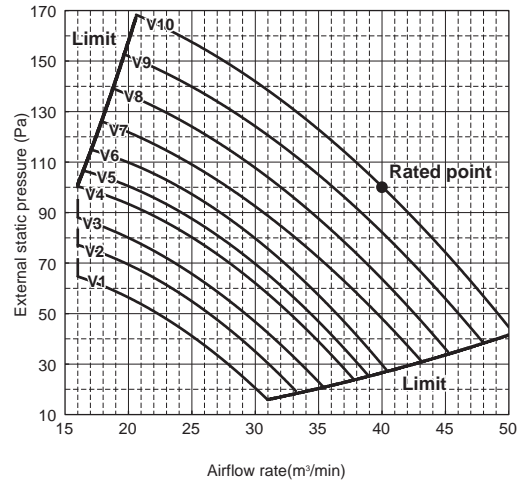

PEFY-P140VMA(L)-E

(External static pressure 50Pa) 220-240V 50/60Hz

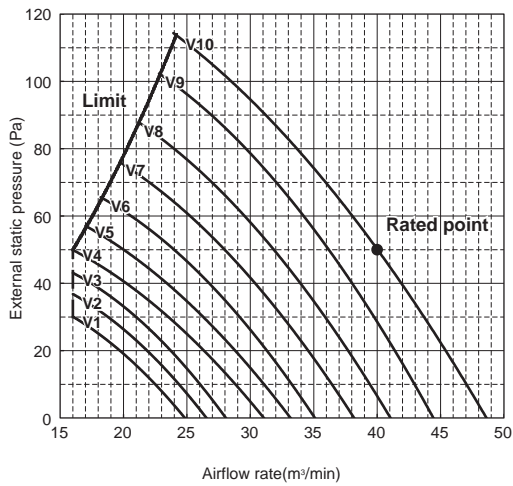

PEFY-P140VMA(L)-E

(External static pressure 150Pa) 220-240V 50/60Hz

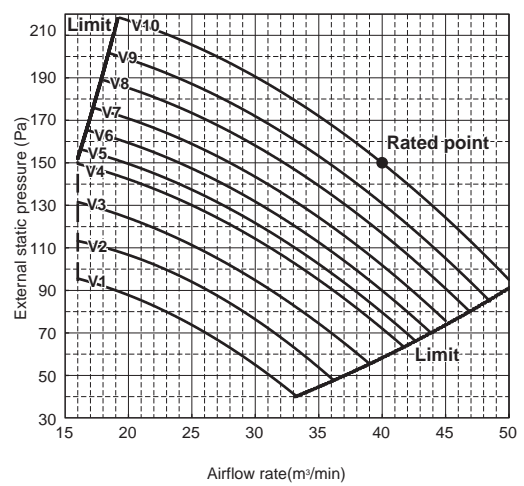

PEFY-P140VMA(L)-E

(External static pressure 70Pa) 220-240V 50/60Hz

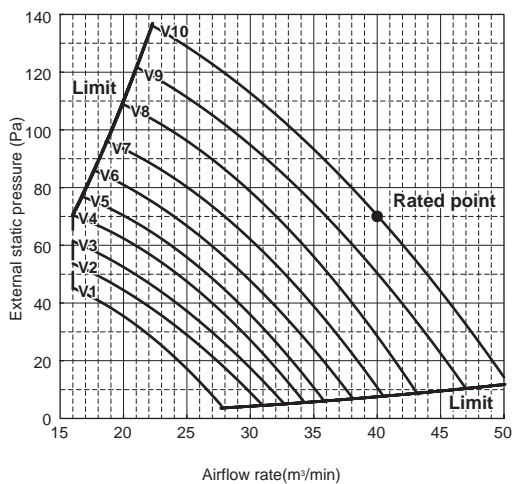

4. Restrictions

Damper system controller setting will be prioritized. Set function on a damper system controller.

Also, settings and error codes set by a remote controller will not be reflected to the damper system controller.

Signal priority: Damper System remote controller > (analog input) > ME or MA remote controller

*** Analog input: only air volume control will be effected**

Function	Model	Restrictions	Cause / status
Operation mode	PEFY *1	If there are cooling/heating simultaneous operation set from damper system controller in a system of Y series outdoor unit + multiple indoor unit, damper system remote controller will display operation mode but indoor fan may stop.	Indoor unit fan will stop when a different mode from outdoor unit operation mode is selected.
	PEFY *1	Operation mode cannot be controlled with M-NET system controller.	If an operation mode is prohibited, operation mode will be displayed, but indoor unit will operate in FAN mode.
Analog input	PEAD	Do not combine level input of indoor unit ON/OFF and IT transmission.	Level input is prioritized and damper system controller input will be invalid.
Error	PEAD	Transmission error cannot be detected when the IT transmission line is cutoff or the connector is not plugged in.	After the IT transmission line cut is fixed or the connector is plugged in, CN105 will automatically recover. If indoor units cannot be controlled from damper system remote controller, check the IT transmission line or the connector.
	PEAD *1	Indoor unit error code will not be displayed on damper system remote controller.	Indoor unit error will be notified by CN105 transmission. To check error code when in service, setting of MA or ME remote controller is recommended.
Prohibition	PEAD	ON/OFF control from damper system remote controller is not available when ON/OFF operation is prohibited from system remote controller.	Because operation prohibition will be prioritized, setting at damper system controller will be invalid. Do not combine ON/OFF prohibition and IT transmission.
Model	PEAD PEFY	Damper system setting is not available for models PEAD-RP35, 50JA(L), PEFY-P20, 25, 32, 40, 50VMA(L)-E.	For these models, air volume will not change with damper system setting.
Damper specification	PEAD *2	Use bypass damper to prevent rapid change in external static pressure. If bypass damper is not available, set a delay timer circuit which starts the damper in 1 minute after receiving damper system input to indoor unit.	In heating, to protect the unit, unit may stop due to high pressure error. When bypass damper is not used, as shown in the below figure, operation range will be limited depending on inlet temperature.

*1 Check operation. No restrictions in functions when 0-10V analog input is connected on its own.

*2 Refer to the below diagram of operation temperature range when bypass damper is not available and when there is no damper delay operation.

Operation temperature range:

To protect unit, there are restrictions when bypass damper is not available and when there is no damper delay operation for 1 minute. The restriction will depend on piping length and air inlet temperature.

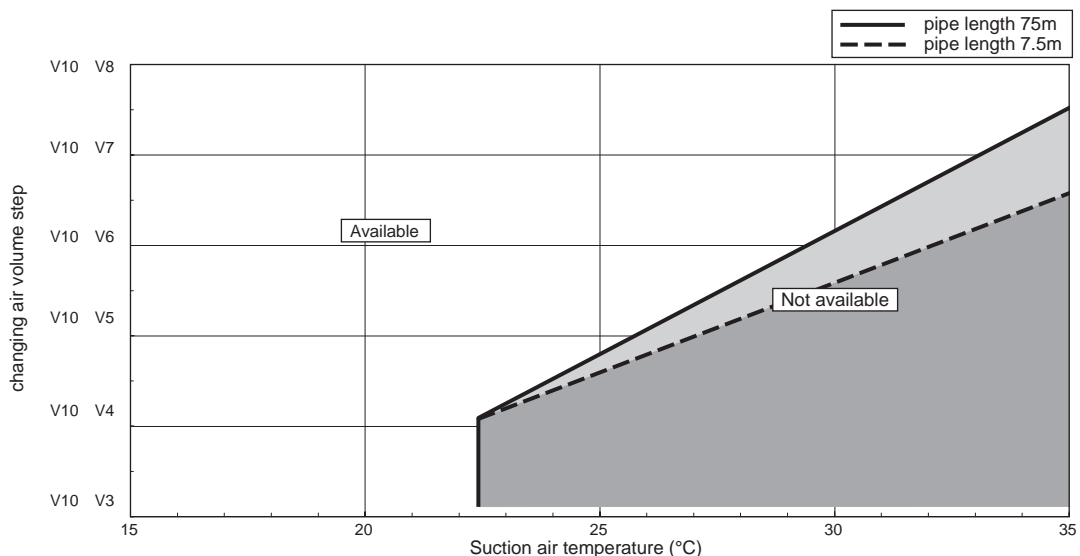

5. Wiring

Conduct electrical wiring in the following order.

Wiring must be done with the power OFF.

(1) Take off the cover by removing 3 screws from the controller box.

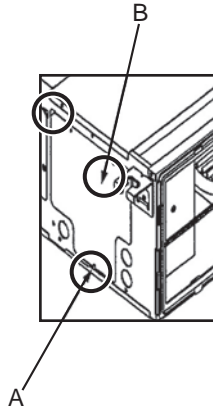

A : Screw holding cover (1pc)

B : Cover

(2) Bore knockout hole for wiring.

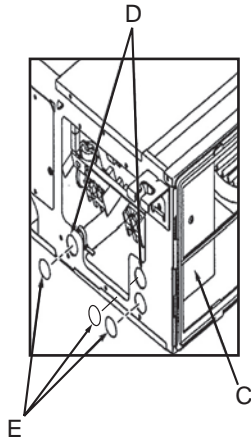

C : Terminal box

D : Knockout hole

E : Remove

(3) Run wiring CN105 and CN2A through a knockout hole.

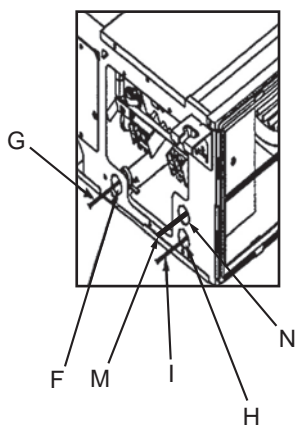

F : Use PG Bushing to keep the weight of the cable and force from being applied to the power supply terminal connector. Use a cable tie to secure the cable.

G : Power source wiring

H : Use ordinary bushing

I : Transmission wiring

M : CN2A(0-10V Analog Input), CN105 wiring

N : Use ordinary bushing

(4) Plug in connector CN105 (red) and CN2A (black) to the indoor controller board. Supply connectors to CN2A and CN105 on site.

- ①CN105 (RED)
- ②CN2A (BLACK) 0-10V analog input

①CN105 (RED)

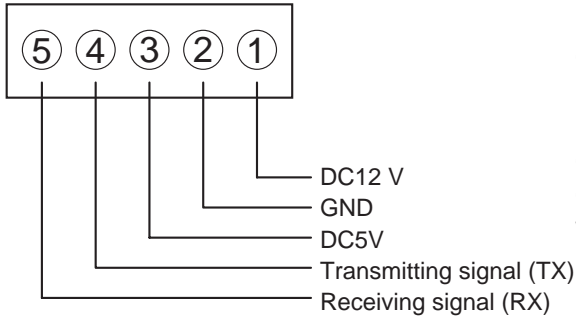

Specification: Indoor unit controller board side
Connector housingB05B-PARK-1

Specification: Connector side (supplied on site)
Connector housingPAP-05V-R
ContactSPHD-002T-P0.5
WiringAWG22 ~ 26

②CN2A (BLACK) Analog input 0 ~ 10V

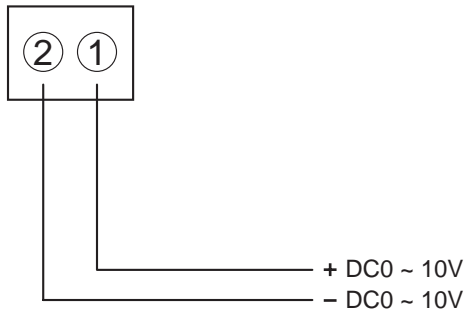

Specification: Indoor unit controller board side
Connector housingB02B-XAKK-1

Specification: Connector side (supplied on site)
Connector housingXAP-02V-1-K
ContactS-XA-001T-P0.6
WiringAWG22 ~ 26

■PEAD-RP60,71,100,125,140JA(L)

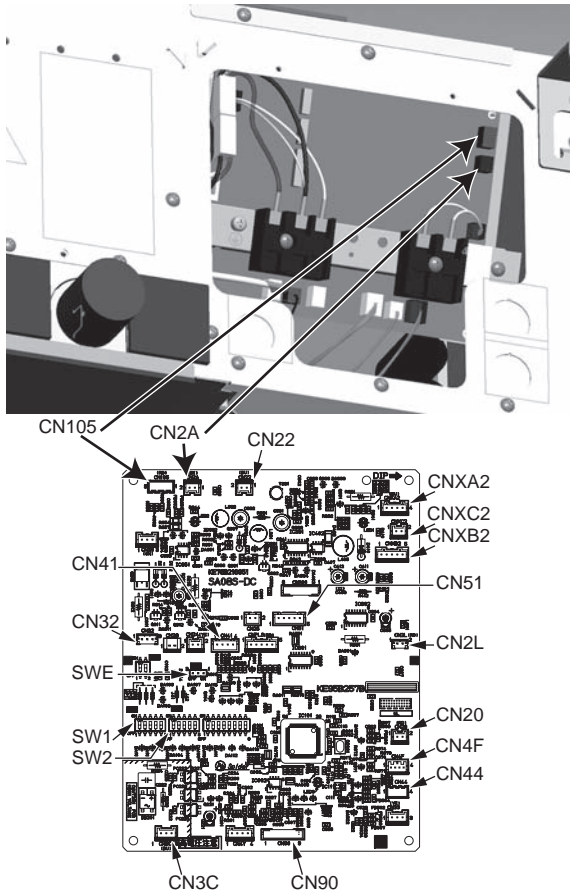

■PEFY-P63,71,80,100,125,140VMA(L)-E

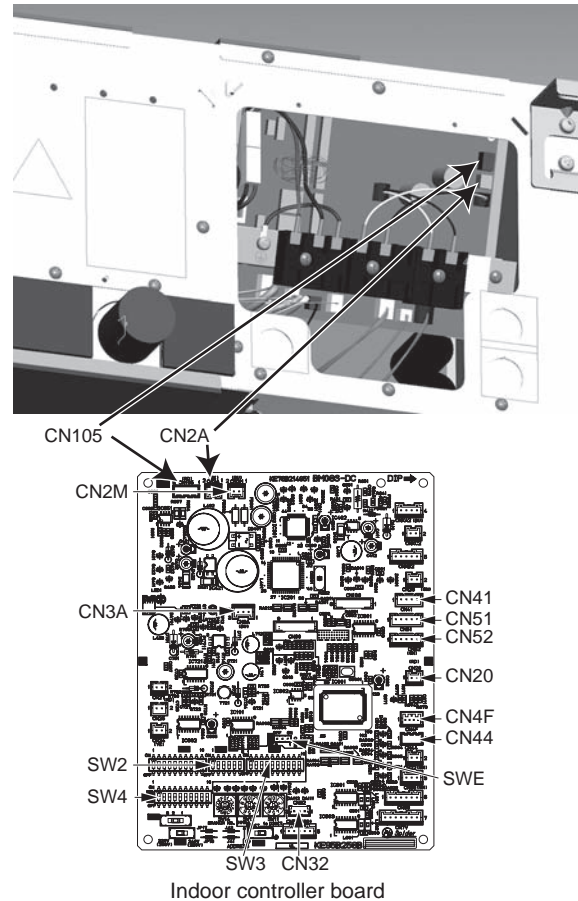

6. Function settings

Set power supply switching, external static pressure setting, and damper system switching. Setting must be done with the power OFF.

External static pressure must be at the rated air volume when all the damper is full open.

6-1. Damper System switch setting

■PEAD-RP60,71,100,125,140JA(L)

0-10V analog input is valid by switching SW1-1 ON.

	With Damper System	Without Damper System
SW1-1	ON	OFF

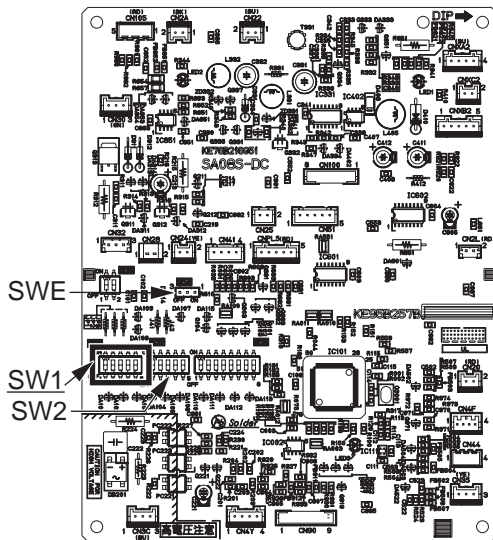

■PEFY-P63,71,80,100,125,140VMA(L)-E

0-10V analog input is valid by switching SW3-6 ON.

	With Damper System	Without Damper System
SW3-6	ON	OFF

(Initial setting OFF)

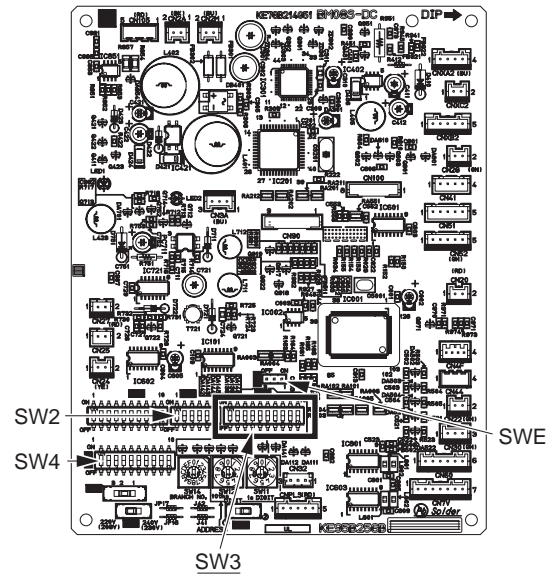

6-2. Changing the power voltage setting

■PEAD-RP60,71,100,125,140JA(L)

Change power voltage setting by function selection via the remote controller

Settings	Mode no.	Setting no.	Initial setting
240V	04	1	
220,230V		2	○

■PEFY-P63,71,80,100,125,140VMA(L)-E

Change power voltage setting by dip switch

Settings	SW5		Initial setting
220, 230V	220V	ON	
240V	240V	OFF	○

6-3. Selecting the external static pressure

■PEAD-RP60,71,100,125,140JA(L)

Change external static pressure setting by function selection via the remote controller

External static pressure	Setting no. of mode no.08	Setting no. of mode no.10	Initial setting
35Pa	2	1	
50Pa	3	1	○
70Pa	1	2	
100Pa	2	2	
150Pa	3	2	

■PEFY-P63,71,80,100,125,140VMA(L)-E

Change external static pressure setting by dip switch

External static pressure	Switch operation
35 Pa	
50 Pa	
70 Pa	
100 Pa	
150 Pa	

PRECAUTION:

External static pressure must be at the rated air volume when all the damper is full open.
 Set a bypass damper to secure minimum air volume with a minimum damper opening.
 (Refer to 3.Fan characteristic curves)

