

SERVICE MANUAL

Series PKA Wall Mounted R407C/R410A

 Indoor unit
 [Model names]

PKA-RP35GAL

PKA-RP50GAL

[Service Ref.]

**PKA-RP35GAL
PKA-RP50GAL**

Revision :

- RoHS PARTS LIST has been added.
- Please void OC330.

Series PKH

R407C

PKH-P35GALH

PKH-P50GALH

**PKH-P35GALH
PKH-P50GALH**

Note :

- This manual describes only service data of the indoor units.
 - RoHS compliant products have <G> mark on spec name plate.
- For servicing of RoHS compliant products, refer to the RoHS Parts List.

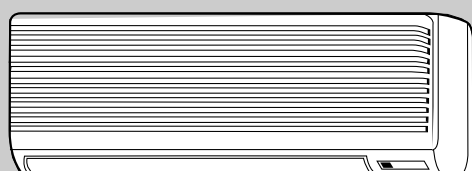

Indoor unit

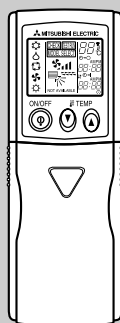
 Model name
 indication

Remote controller

CONTENTS

1. REFERENCE MANUAL	2
2. SAFETY PRECAUTION	3
3. PART NAMES AND FUNCTIONS	7
4. SPECIFICATIONS	9
5. NOISE CRITERION CURVES	11
6. OUTLINES AND DIMENSIONS	12
7. WIRING DIAGRAM	13
8. REFRIGERANT SYSTEM DIAGRAM	14
9. TROUBLE SHOOTING	15
10. DISASSEMBLY PROCEDURE	30
11. PARTS LIST	34
12. RoHS PARTS LIST	37

1-1. OUTDOOR UNIT'S SERVICE MANUAL

Service Ref.	Service Manual No.
PUHZ-RP35/50/60/71/100/125/140VHA ₍₁₎ PUHZ-RP100/125/140YHA ₍₁₎	OC334
PUHZ-RP71/100/125/140VHA ₍₁₎ -A	OC337
PUHZ-RP200/250YHA ₍₁₎	OC338
PUHZ-RP200/250YHA ₍₁₎ -A	OC339
PU(H)-P-VGAA.UK PU(H)-P-YGAA.UK	OC336
PUHZ-RP35/50/60/71/100/125/140VHA2 PUHZ-RP100/125/140YHA2	OC374
PU(H)-P71/100VHA.UK PU(H)-P71/100/125/140YHA.UK	OC379
PUHZ-P100/125/140VHA.UK	OC359

1-2. TECHNICAL DATA BOOK

Series (Outdoor unit)	Manual No.
PUHZ-RP.VHA(-A) PUHZ-RP.YHA(-A)	OCS01
PU(H)-P-VGAA.UK PU(H)-P-YGAA.UK	OCS02
PUHZ-RP.VHA2 PUHZ-RP.YHA2	OCS05
PUHZ-P.VHA	OCS06
PU(H)-P.VHA PU(H)-P.YHA	OCS07

CAUTIONS RELATED TO NEW REFRIGERANT

Cautions for units utilizing refrigerant R407C

Do not use the existing refrigerant piping.

The old refrigerant and lubricant in the existing piping contains a large amount of chlorine which may cause the lubricant deterioration of the new unit.

Use liquid refrigerant to seal the system.

If gas refrigerant is used to seal the system, the composition of the refrigerant in the cylinder will change and performance may drop.

Use "low residual oil piping"

If there is a large amount of residual oil (hydraulic oil, etc.) inside the piping and joints, deterioration of the lubricant will result.

Do not use a refrigerant other than R407C.

If another refrigerant (R22, etc.) is used, the chlorine in the refrigerant may cause the lubricant deterioration.

**Store the piping to be used during installation indoors with keep both ends sealed until just before brazing.
(Store elbows and other joints in a plastic bag.)**

If dust, dirt, or water enters the refrigerant cycle, deterioration of the oil and compressor trouble may result.

Use a vacuum pump with a reverse flow check valve.

The vacuum pump oil may flow back into the refrigerant cycle and cause the lubricant deterioration.

Use ESTER , ETHER or HAB as the lubricant to coat flares and flange connection parts.

If large amount of mineral oil enter, that can cause deterioration of refrigerant oil etc.

Ventilate the room if refrigerant leaks during operation. If refrigerant comes into contact with a flame, poisonous gases will be released.**[1] Cautions for service**

- After recovering the all refrigerant in the unit, proceed to working.
- Do not release refrigerant in the air.
- After completing the repair service, recharge the cycle with the specified amount of liquid refrigerant.

[2] Refrigerant recharging**(1) Refrigerant recharging process****① Direct charging from the cylinder.**

- R407C cylinder are available on the market has a syphon pipe.
- Leave the syphon pipe cylinder standing and recharge it.
(By liquid refrigerant)

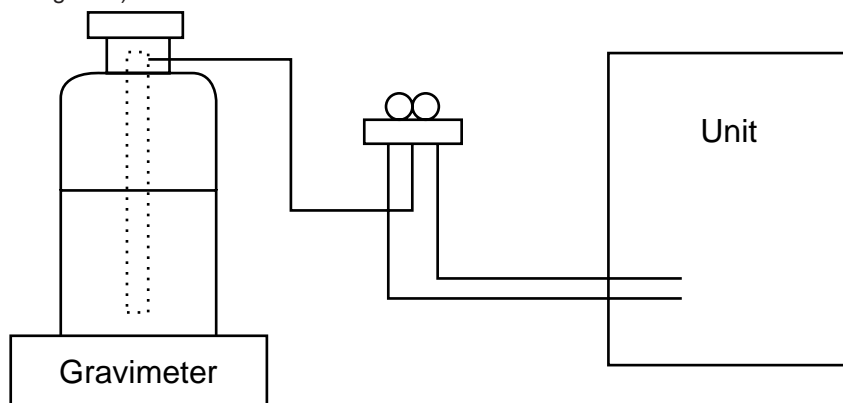
**(2) Recharge in refrigerant leakage case**

- After recovering the all refrigerant in the unit, proceed to working.
- Do not release the refrigerant in the air.
- After completing the repair service, recharge the cycle with the specified amount of liquid refrigerant.

[3] Service tools

Use the below service tools as exclusive tools for R407C refrigerant.

No.	Tool name	Specifications
①	Gauge manifold	·Only for R407C.
		·Use the existing fitting SPECIFICATIONS. (UNF7/16)
		·Use high-tension side pressure of 3.43MPa-G or over.
②	Charge hose	·Only for R407C.
		·Use pressure performance of 5.10MPa-G or over.
③	Electronic scale	
④	Gas leak detector	·Use the detector for R134a or R407C.
⑤	Adapter for reverse flow check.	·Attach on vacuum pump.
⑥	Refrigerant charge base.	
⑦	Refrigerant cylinder.	·For R407C ·Top of cylinder (Brown)
		·Cylinder with syphon
⑧	Refrigerant recovery equipment.	

CAUTIONS RELATED TO NEW REFRIGERANT

Cautions for units utilizing refrigerant R410A

Use new refrigerant pipes.

In case of using the existing pipes for R22, be careful with the followings.

- Change flare nut to the one provided with this product. Use a newly flared pipe.
- Avoid using thin pipes.

Make sure that the inside and outside of refrigerant piping is clean and it has no contamination such as sulfur hazardous for use, oxides, dirt, shaving particles, etc. In addition, use pipes with specified thickness.

Contamination inside refrigerant piping can cause deterioration of refrigerant oil etc.

Store the piping to be used during installation indoors and keep both ends of the piping sealed until just before brazing. (Leave elbow joints, etc. in their packaging.)

If dirt, dust or moisture enter into refrigerant cycle, that can cause deterioration of refrigerant oil or malfunction of compressor.

Use ester oil, ether oil or alkylbenzene oil (small amount) as the refrigerant oil applied to flares and flange connections.

If large amount of mineral oil enter, that can cause deterioration of refrigerant oil etc.

Charge refrigerant from liquid phase of gas cylinder.

If the refrigerant is charged from gas phase, composition change may occur in refrigerant and the efficiency will be lowered.

Do not use refrigerant other than R410A.

If other refrigerant (R22 etc.) is used, chlorine in refrigerant can cause deterioration of refrigerant oil etc.

Use a vacuum pump with a reverse flow check valve.

Vacuum pump oil may flow back into refrigerant cycle and that can cause deterioration of refrigerant oil etc.

Use the following tools specifically designed for use with R410A refrigerant.

The following tools are necessary to use R410A refrigerant.

Tools for R410A	
Gauge manifold	Flare tool
Charge hose	Size adjustment gauge
Gas leak detector	Vacuum pump adaptor
Torque wrench	Electronic refrigerant charging scale

Keep the tools with care.

If dirt, dust or moisture enter into refrigerant cycle, that can cause deterioration of refrigerant oil or malfunction of compressor.

Do not use a charging cylinder.

If a charging cylinder is used, the composition of refrigerant will change and the efficiency will be lowered.

Ventilate the room if refrigerant leaks during operation. If refrigerant comes into contact with a flame, poisonous gases will be released.

[1] Cautions for service

- (1) Perform service after collecting the refrigerant left in unit completely.
- (2) Do not release refrigerant in the air.
- (3) After completing service, charge the cycle with specified amount of refrigerant.
- (4) When performing service, install a filter drier simultaneously.
Be sure to use a filter drier for new refrigerant.

[2] Additional refrigerant charge

When charging directly from cylinder

- Check that cylinder for R410A on the market is syphon type.
- Charging should be performed with the cylinder of syphon stood vertically. (Refrigerant is charged from liquid phase.)

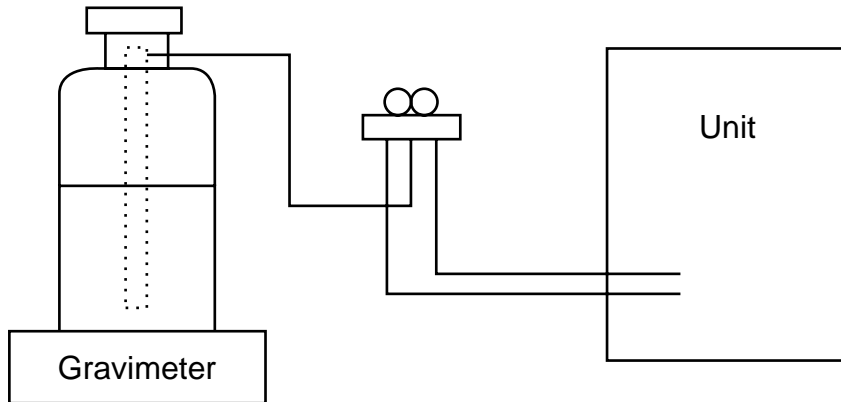

[3] Service tools

Use the below service tools as exclusive tools for R410A refrigerant.

No.		Specifications
①	Gauge manifold	·Only for R410A
		·Use the existing fitting specifications. (UNF1/2)
		·Use high-tension side pressure of 5.3MPa·G or over.
②	Charge hose	·Only for R410A
		·Use pressure performance of 5.09MPa·G or over.
③	Electronic scale	—
④	Gas leak detector	·Use the detector for R134a, R407C or R410A.
⑤	Adaptor for reverse flow check	·Attach on vacuum pump.
⑥	Refrigerant charge base	—
⑦	Refrigerant cylinder	·Only for R410A Top of cylinder (Pink)
		Cylinder with syphon
⑧	Refrigerant recovery equipment	—

3

PART NAMES AND FUNCTIONS

● Indoor Unit

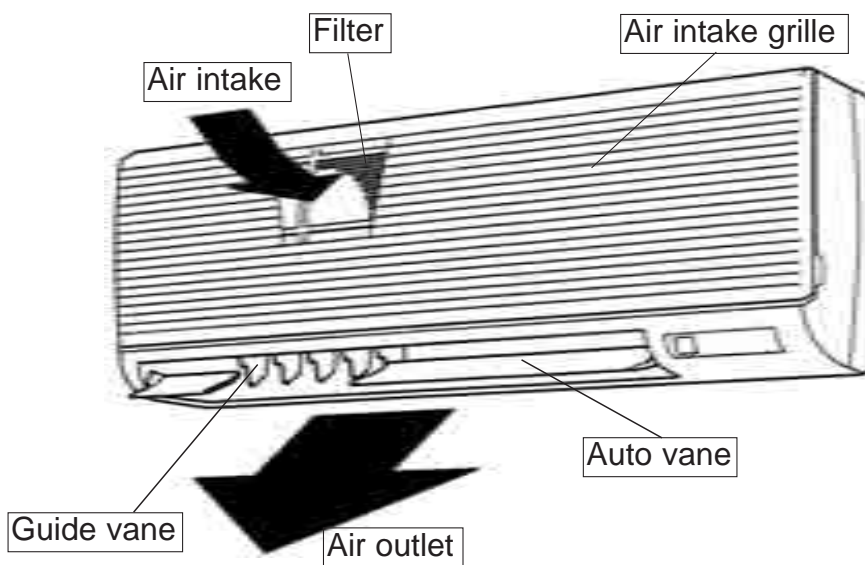

●Wireless remote controller

- When cover is open.

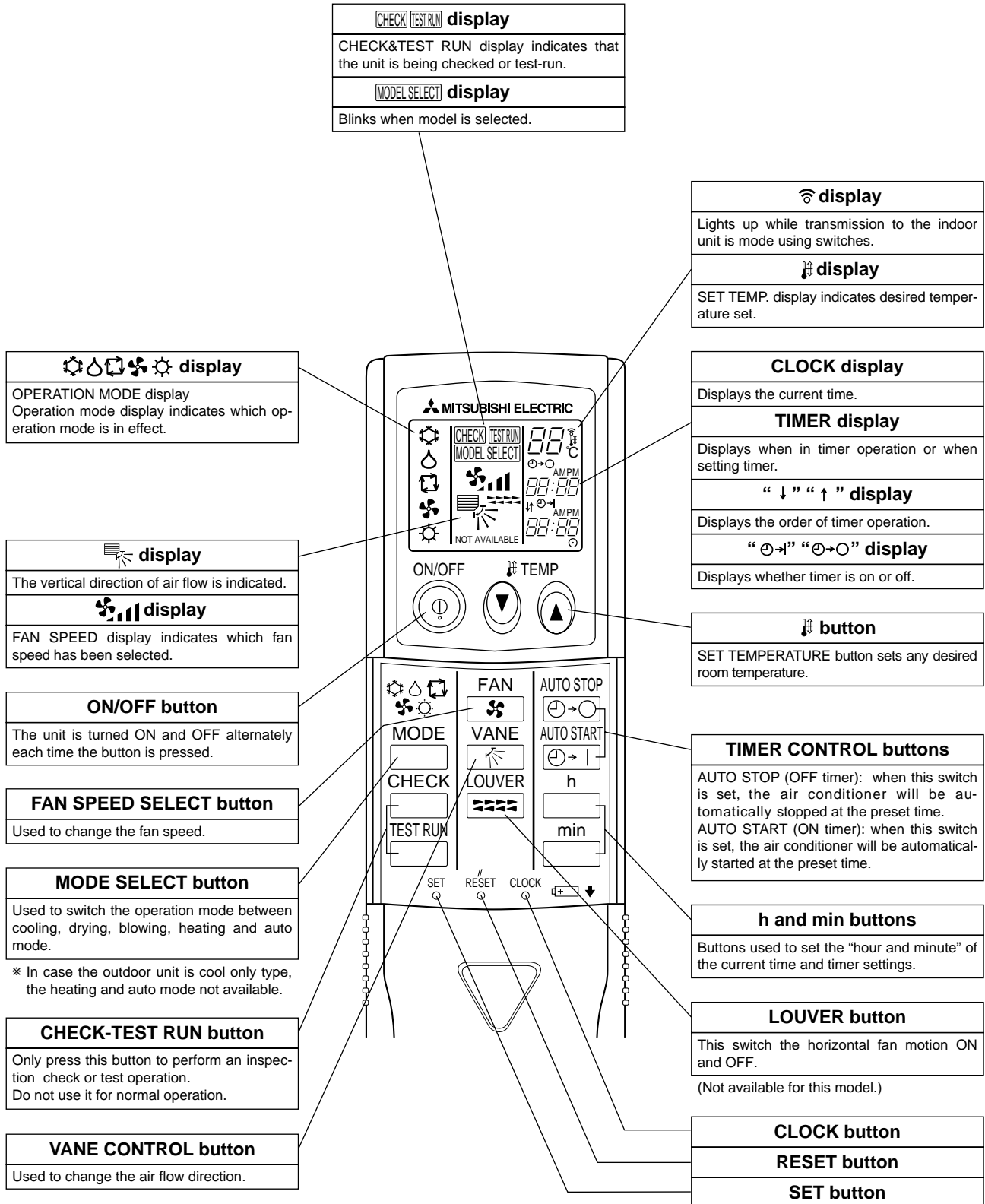

4

SPECIFICATIONS

Service Ref.			PKA-RP35GAL		
INDOOR UNIT	Mode		Cooling	Heating	
	Power supply(phase, cycle, voltage)		Single phase, 50Hz, 230V		
	Input	kW	0.07	0.07	
	Running current	A	0.33	0.33	
	Starting current	A	0.40	0.40	
	External finish		Munsell 0.70Y 8.59/0.97		
	Heat exchanger		Plate fin coil		
	Fan	Fan(drive) x No.		Line flow (direct) x 1	
		Fan motor output	kW	0.030	
		Airflow(Low-Medium2-Medium1-High)	m ³ /min(CFM)	9-10-11-12(320-355-390-425)	
		External static pressure	Pa(mmAq)	0(direct blow)	
	Operation control & Thermostat		Wireless remote controller & built-in		
	Noise level(Low-Medium2-Medium1-High)		dB		36-38-41-43
	Unit drain pipe O.D.		mm(in.)	20(13/16)	
	Dimensions	W	mm(in.)	990(39)	
D		mm(in.)	235(9-1/4)		
H		mm(in.)	340(13-3/8)		
Weight		kg(lbs)	16(35)		

Service Ref.			PKA-RP50GAL		
INDOOR UNIT	Mode		Cooling	Heating	
	Power supply(phase, cycle, voltage)		Single phase, 50Hz, 230V		
	Input	kW	0.07	0.07	
	Running current	A	0.33	0.33	
	Starting current	A	0.40	0.40	
	External finish		Munsell 0.70Y 8.59/0.97		
	Heat exchanger		Plate fin coil		
	Fan	Fan(drive) x No.		Line flow (direct) x 1	
		Fan motor output	kW	0.030	
		Airflow(Low-Medium2-Medium1-High)	m ³ /min(CFM)	9-10-11-12(320-355-390-425)	
		External static pressure	Pa(mmAq)	0(direct blow)	
	Operation control & Thermostat		Wireless remote controller & built-in		
	Noise level(Low-Medium2-Medium1-High)		dB		36-38-41-43
	Unit drain pipe O.D.		mm(in.)	20(13/16)	
	Dimensions	W	mm(in.)	990(39)	
D		mm(in.)	235(9-1/4)		
H		mm(in.)	340(13-3/8)		
Weight		kg(lbs)	16(35)		



Service Ref.			PKH-P35GALH	
Mode			Cooling	Heating
Power supply(phase, cycle,voltage)			Single phase, 50Hz, 230V	
	Input ※1	kW	0.07	0.07<0.73>
	Running current ※1	A	0.33	0.33<3.17>
	Starting current ※1	A	0.40	0.40<3.17>
External finish			Munsell 0.70Y8.59/0.97	
Heat exchanger			Plate fin coil	
INDOOR UNIT	Fan	Fan(drive) x No.	Line flow (direct) x 1	
		Fan motor output	0.030	
		Airflow(Low-Medium2-Medium1-High)	m ³ /min(CFM)	
		External static pressure	Pa(mmAq)	
Booster heater ※1			kW	
Operation control & Thermostat			Wireless remote controller & built-in	
Noise level(Low-Medium2-Medium1-High)			dB	
Unit drain pipe O.D.			mm(in.)	
Dimensions	W	mm(in.)	990(39)	
	D	mm(in.)	235(9-1/4)	
	H	mm(in.)	340(13-3/8)	
Weight			kg(lbs)	

※1 : < > Shows the only booster heater rating.

Service Ref.			PKH-P50GALH	
Mode			Cooling	Heating
Power supply(phase, cycle,voltage)			Single phase, 50Hz, 230V	
	Input ※1	kW	0.07	0.07<0.73>
	Running current ※1	A	0.33	0.33<3.17>
	Starting current ※1	A	0.40	0.40<3.17>
External finish			Munsell 0.70Y 8.59/0.97	
Heat exchanger			Plate fin coil	
INDOOR UNIT	Fan	Fan(drive) x No.	Line flow (direct) x 1	
		Fan motor output	0.030	
		Airflow(Low-Medium2-Medium1-High)	m ³ /min(CFM)	
		External static pressure	Pa(mmAq)	
Booster heater ※1			kW	
Operation control & Thermostat			Wireless remote controller & built-in	
Noise level(Low-Medium2-Medium1-High)			dB	
Unit drain pipe O.D.			mm(in.)	
Dimensions	W	mm(in.)	990(39)	
	D	mm(in.)	235(9-1/4)	
	H	mm(in.)	340(13-3/8)	
Weight			kg(lbs)	

※1 : < > Shows the only booster heater rating.

PKA-RP35GAL
PKA-RP50GAL
PKH-P35GALH
PKH-P50GALH

NOTCH	SPL(dB)	LINE
High	43	○—○
Medium1	41	△—△
Medium2	38	●—●
Low	36	▲—▲

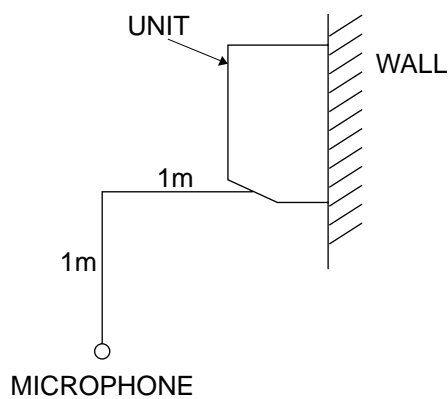
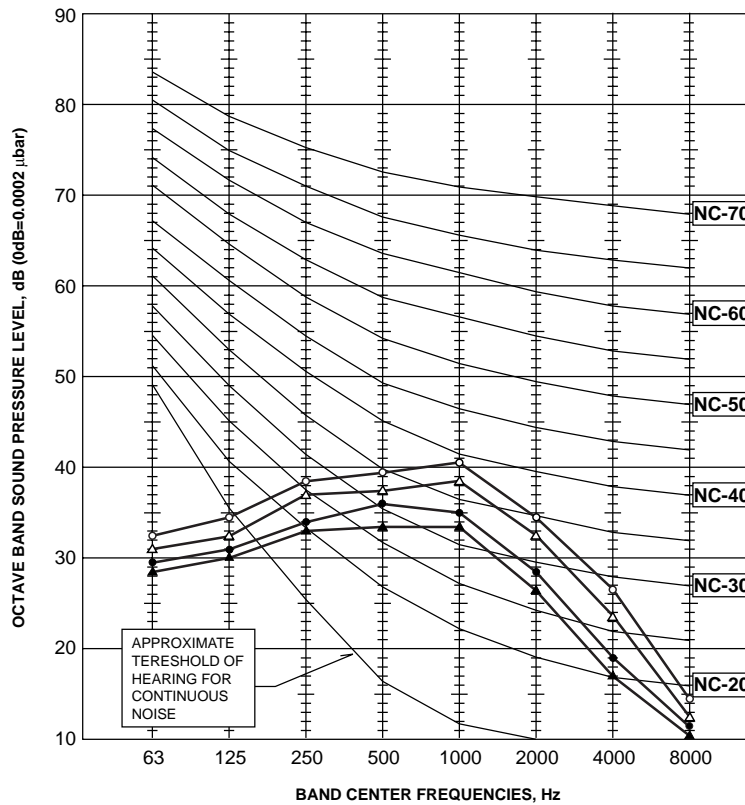

INDOOR UNIT

PKH-P35GALH PKH-P50GALH PKA-RP35GAL PKA-RP50GAL

Unit : mm

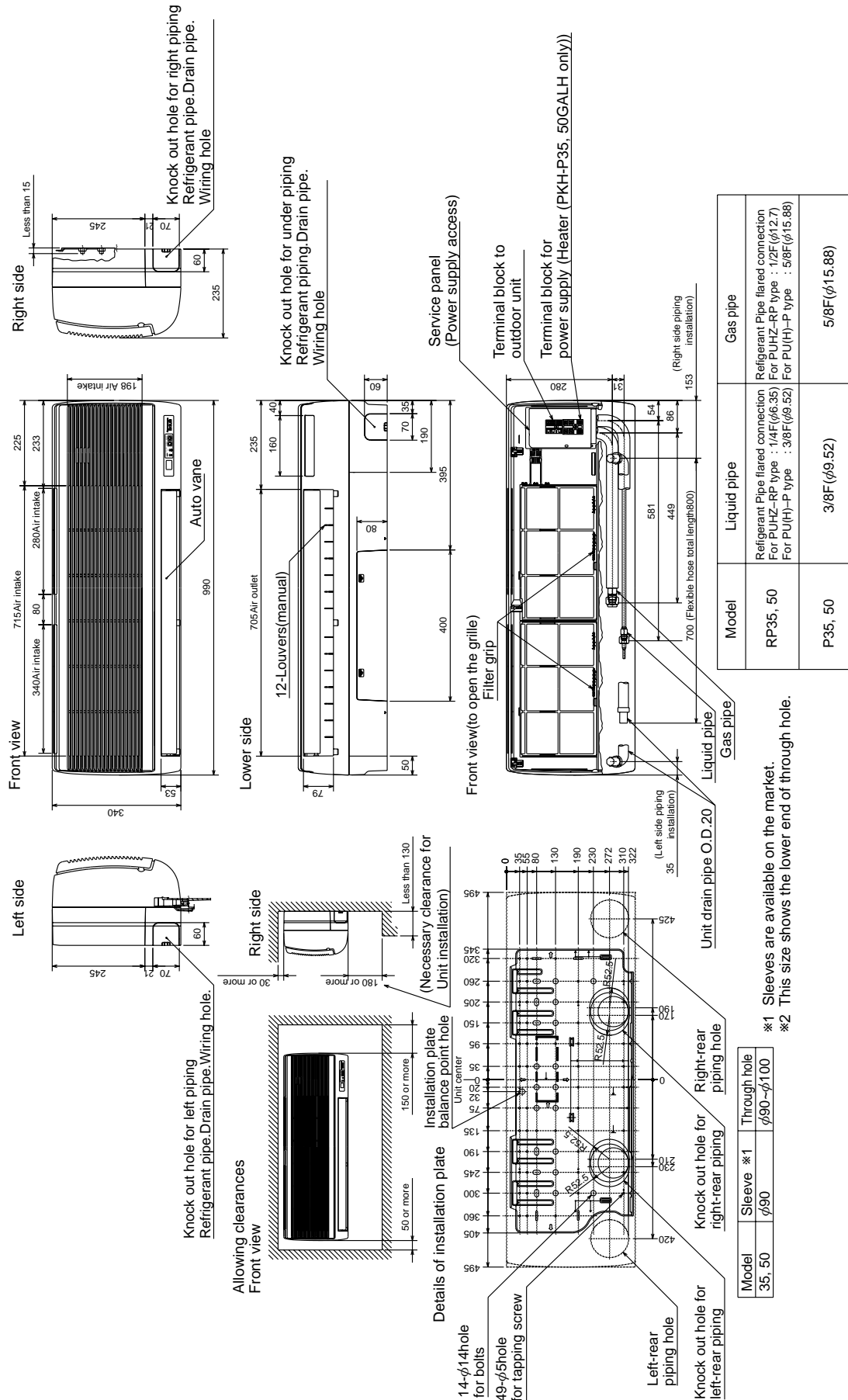

*1 Sleeves are available on the market.
 *2 This size shows the lower end of through hole.

7

WIRING DIAGRAM

PKH-P35GALH PKH-P50GALH PKA-RP35GAL PKA-RP50GAL

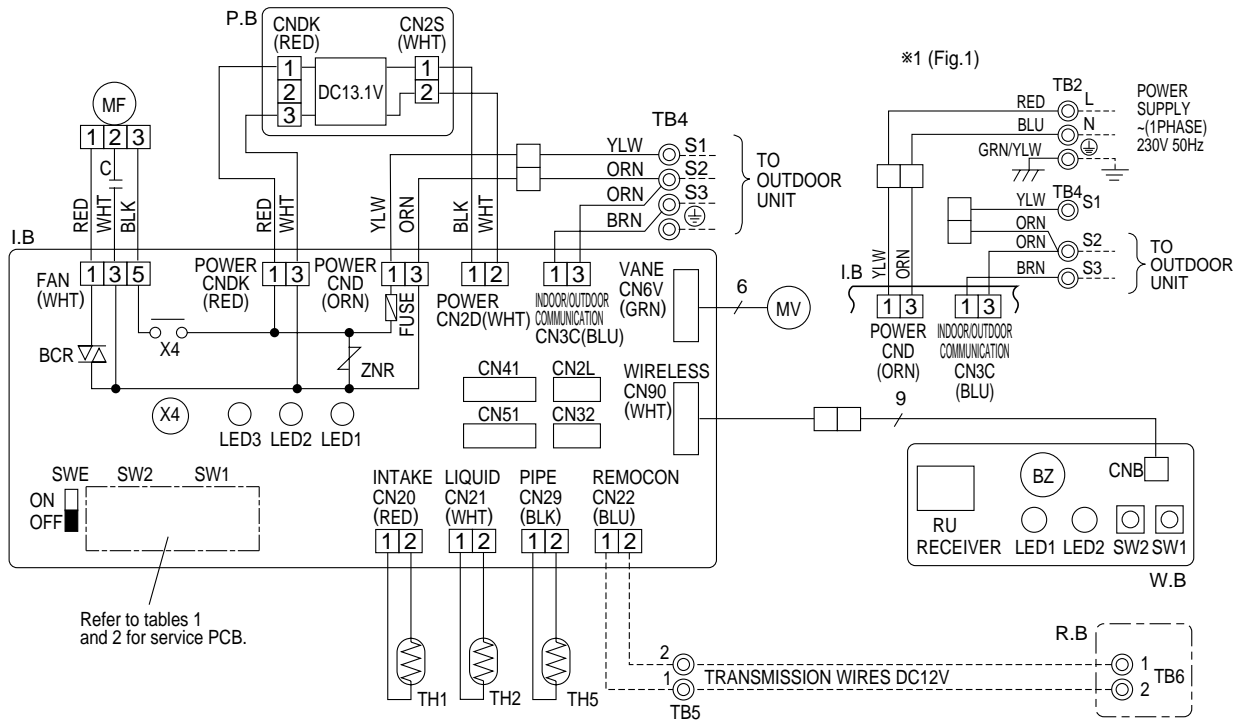

PKH-P35,50GALH models only

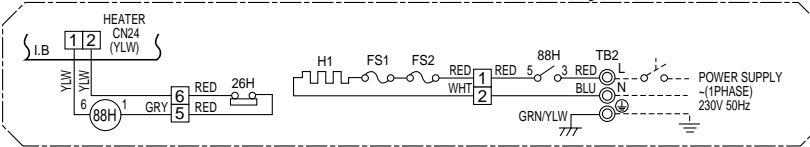

Please set the voltage using the remote controller.
For the setting method, please refer to the indoor unit Installation Manual.

SW1					SW2											
Service board					MODELS	Service board	MODELS	Service board								
1	2	3	4	5	PKA-RP35GAL	1	2	3	4	5	PKA-RP50GAL	1	2	3	4	5
ON	OFF	ON	OFF	ON	PKH-P35GALH	ON	OFF	ON	OFF	ON	PKH-P50GALH	ON	OFF	ON	OFF	ON

SYMBOL	NAME	SYMBOL	NAME	SYMBOL	NAME
P.B	INDOOR POWER BOARD	C	CAPACITOR <FAN MOTOR>	W.B	WIRELESS REMOTE CONTROLLER BOARD
I.B	INDOOR CONTROLLER BOARD	MF	FAN MOTOR	RU	RECEIVING UNIT
FUSE	FUSE (T6.3AL250V)	MV	VANE MOTOR	BZ	BUZZER
ZNR	VARIATOR	TB2	TERMINAL BLOCK (HEATER) *PKH-P.GALH models only or option for PKA-RP.GAL models.	LED1	LED <RUN INDICATOR>
CN2L	CONNECTOR <LOSSNAY>	TB4	TERMINAL BLOCK <INDOOR/ OUTDOOR CONNECTING LINE>	LED2	LED <HOT ADJUST>
CN32	CONNECTOR <REMOTE SWITCH>	TB5, TB6	TERMINAL BLOCK <REMOTE CONTROLLER TRANSMISSION LINE> <OPTION>	SW1	SWITCH (HEATING ON/ OFF)
CN41	CONNECTOR <HA TERMINAL-A>			SW2	SWITCH (COOLING ON/ OFF)
CN51	CONNECTOR <CENTRALLY CONTROL>			R.B	WIRED REMOTE CONTROLLER BOARD
SW1	SWITCH <MODEL SELECTION>*See Table 1.	TH1	ROOM TEMP.THERMISTOR <0°C / 15kΩ, 25°C / 5.4kΩ DETECT>	HEATER	
SW2	SWITCH <CAPACITY CODE>*See Table 2.	TH2	PIPE TEMP.THERMISTOR/ LIQUID <0°C / 15kΩ, 25°C / 5.4kΩ DETECT>	FS1	THERMAL FUSE <104°C 10A>
SWE	SWITCH <EMERGENCY OPERATION>	TH5	COND./ EVA.TEMP.THERMISTOR <0°C / 15kΩ, 25°C / 5.4kΩ DETECT>	FS2	THERMAL FUSE <84°C 10A>
X4	RELAY <FAN MOTOR>			H1	HEATER
BCR	FAN CONTROL ELEMENT			26H	HEATER THERMAL SWITCH
LED1	POWER SUPPLY <I.B>			88H	HEATER THERMAL SWITCH
LED2	POWER SUPPLY <R.B>				
LED3	TRANSMISSION <INDOOR-OUTDOOR>				

NOTES:

- Since the outdoor side electric wiring may change be sure to check the outdoor unit electric wiring for servicing.
- Indoor and outdoor connecting wires are made with polarities, make wiring matching terminal numbers (S1, S2, S3).
- Make sure that the main power supply of the booster heater is independent.
- Symbols used in wiring diagram above are, □□□□: Connector, ⊙: Terminal (block).
 - *1. When work to supply power separately to Indoor and Outdoor unit was applied, refer to Fig 1.
 - *2. For power supply system of this unit, refer to the caution label located near this diagram.

PKA-RP35GAL PKH-P35GALH
PKA-RP50GAL PKH-P50GALH

Unit : mm

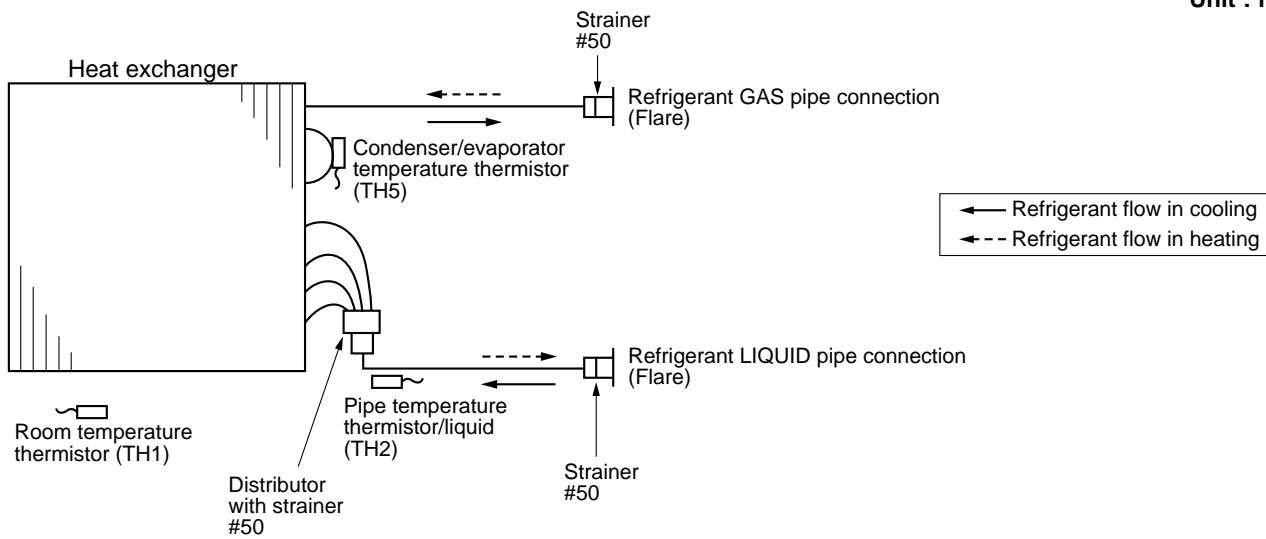

9-1. TROUBLESHOOTING

<Error code display by self-diagnosis and actions to be taken for service (summary)>

Present and past error codes are logged and displayed on the wired remote controller or controller board of outdoor unit. Actions to be taken for service and the inferior phenomenon reoccurrence at field are summarized in the table below. Check the contents below before investigating details.

Unit conditions at service	Error code	Actions to be taken for service (summary)
The inferior phenomenon is reoccurring.	Displayed	Judge what is wrong and take a corrective action according to "SELF-DIAGNOSIS ACTION TABLE" (9-3).
	Not displayed	Identify the cause of the inferior phenomenon and take a corrective action according to "TROUBLESHOOTING BY INFERIOR PHENOMENA" (9-4).
The inferior phenomenon is not reoccurring.	Logged	<ul style="list-style-type: none"> ①Consider the temporary defects such as the work of protection devices in the refrigerant circuit including compressor, poor connection of wiring, noise and etc. Re-check the symptom, and check the installation environment, refrigerant amount, weather when the inferior phenomenon occurred, and wiring related. ②Reset error code logs and restart the unit after finishing service. ③There is no abnormality in electrical components, controller boards, and remote controller.
	Not logged	<ul style="list-style-type: none"> ①Recheck the abnormal symptom. ②Identify the cause of the inferior phenomenon and take a corrective action according to "TROUBLESHOOTING BY INFERIOR PHENOMENA" (9-4). ③Continue to operate unit for the time being if the cause is not ascertained. ④There is no abnormality in electrical components, controller boards, remote controller etc.

9-2. MALFUNCTION-DIAGNOSIS METHOD BY REMOTE CONTROLLER



<In case of trouble during operation>

When a malfunction occurs to air conditioner, both indoor unit and outdoor unit will stop and operation lamp blinks to inform unusual stop.

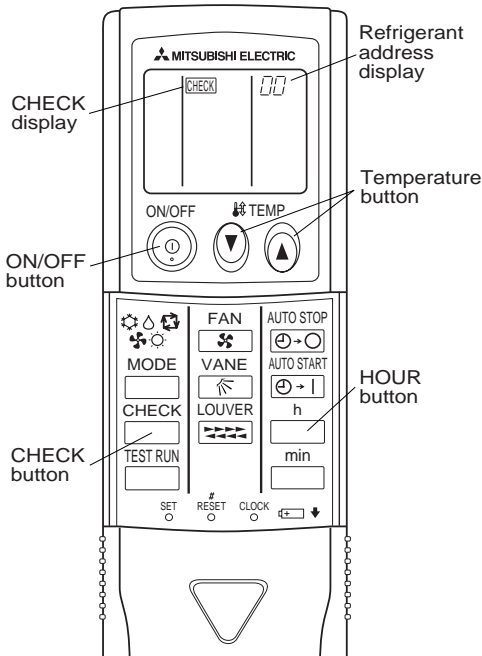
<Malfunction-diagnosis method at maintenance service>



[Procedure]

1. Press the CHECK button twice.
 - "CHECK" lights, and refrigerant address "00" flashes.
 - Check that the remote controller's display has stopped before continuing.
2. Press the temperature   buttons.
 - Select the refrigerant address of the indoor unit for the self-diagnosis.
 - Note: Set refrigerant address using the outdoor unit's DIP switch (SW1). (For more information, see the outdoor unit installation manual.)
3. Point the remote controller at the sensor on the indoor unit and press the HOUR button.
 - If an air conditioner error occurs, the indoor unit's sensor emits an intermittent buzzer sound, the operation light flashes, and the error code is output. (It takes 3 seconds at most for error code to appear.)
4. Point the remote controller at the sensor on the indoor unit and press the ON/OFF button.
 - The check mode is cancelled.

To be continued to the next page.

- Refer to the following tables for details on the check codes.

[Output pattern A]

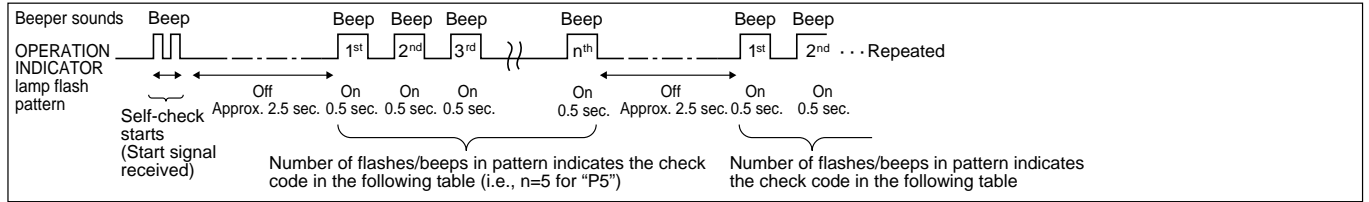

[Output pattern B]

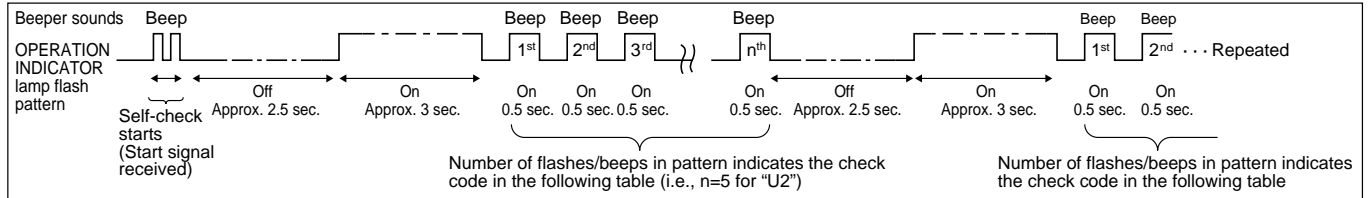

[Output pattern A] Errors detected by indoor unit

Wireless remote controller Beeper sounds/OPERATION INDICATOR lamp flashes (Number of times)	Wired remote controller ① Check code	Symptom	Remark
1	P1	Intake sensor error	
2	P2	Pipe (TH2) sensor error	
	P9	Pipe (TH5) sensor error	
3	E6, E7	Indoor/outdoor unit communication error	
4	P4	Drain sensor error	
5	P5	Drain pump error	
	PA	Forced compressor stop	
6	P6	Freezing/Overheating safeguard operation	
7	EE	Communication error between indoor and outdoor units	
8	P8	Pipe temperature error	
9	E4, E5	Remote controller signal receiving error	
10	-	-	
11	-	-	
12	Fb	Indoor unit control system error (memory error, etc.)	
-	E0, E3	Remote controller transmission error	
-	E1, E2	Remote controller control board error	

[Output pattern B] Errors detected by unit other than indoor unit (outdoor unit, etc.)

Wireless remote controller Beeper sounds/OPERATION INDICATOR lamp flashes (Number of times)	Wired remote controller ① Check code	Symptom	Remark
1	E9	Indoor/outdoor unit communication error (Transmitting error) (Outdoor unit)	For details, check the LED display of the outdoor controller board. As for outdoor unit, refer to outdoor unit's service manual.
2	UP	Compressor overcurrent interruption	
3	U3, U4	Open/short of outdoor unit thermistors	
4	UF	Compressor overcurrent interruption (When compressor locked)	
5	U2	Abnormal high discharging temperature /49C worked/ insufficient refrigerant	
6	U1, Ud	Abnormal high pressure (63H worked) /Overheating safeguard operation	
7	U5	Abnormal temperature of heat sink	
8	U8	Outdoor unit fan safeguard stop	
9	U6	Compressor overcurrent interruption/Abnormal of power module	
10	U7	Abnormality of super heat due to low discharge temperature	
11	U9, UH	Abnormality such as overvoltage or voltage shortage and abnormal synchronous signal to main circuit/Current sensor error	
12	-	-	
13	-	-	
14	Others	Other errors (Refer to the technical manual for the outdoor unit.)	

*1 If the beeper does not sound again after the initial two beeps to confirm the self-check start signal was received and the OPERATION INDICATOR lamp does not come on, there are no error records.

*2 If the beeper sounds three times continuously "beep, beep, beep (0.4 + 0.4 + 0.4 sec.)" after the initial two beeps to confirm the self-check start signal was received, the specified refrigerant address is incorrect.

- On wireless remote controller
- ② The continuous buzzer sounds from receiving section of indoor unit.
- ③ Blink of operation lamp
- On wired remote controller
- ① Check code displayed in the LCD.

• If the unit cannot be operated properly after the test run has been performed, refer to the following table to remove the cause.

Symptom		LED 1, 2 (PCB in outdoor unit)	Cause
Wired remote controller			
PLEASE WAIT	For about 2 minutes following power-on	After LED 1, 2 are lighted, LED 2 is turned off, then only LED 1 is lighted. (Correct operation)	• For about 2 minutes following power-on, operation of the remote controller is not possible due to system start-up. (Correct operation)
PLEASE WAIT → Error code	After about 2 minutes has expired following power-on	Only LED 1 is lighted. → LED 1, 2 blink.	• Connector for the outdoor unit's protection device is not connected. • Reverse or open phase wiring for the outdoor unit's power terminal block (L1, L2, L3)
Display messages do not appear even when operation switch is turned ON (operation lamp does not light up).		Only LED 1 is lighted. → LED 1 blinks twice, LED 2 blinks once.	• Incorrect wiring between indoor and outdoor units (incorrect polarity of S1, S2, S3) • Remote controller wire short

On the wireless remote controller with condition above, following phenomena takes place.

- No signals from the remote controller are accepted.
- Operation lamp is blinking.
- The buzzer makes a short piping sound.

Note:

Operation is not possible for about 30 seconds after cancellation of function selection. (Correct operation)

For description of each LED (LED1, 2, 3) provided on the indoor controller, refer to the following table.

LED1 (power for microcomputer)	Indicates whether control power is supplied. Make sure that this LED is always lit.
LED2 (power for remote controller)	Indicates whether power is supplied to the remote controller. This LED lights only in the case of the indoor unit which is connected to the outdoor unit refrigerant address "0".
LED3 (communication between indoor and outdoor units)	Indicates state of communication between the indoor and outdoor units. Make sure that this LED is always blinking.

Note: Refer to the manual of outdoor unit for the details of display such as F, U, and other E.

9-3. SELF-DIAGNOSIS ACTION TABLE

Error Code	Meaning of error code and detection method	Cause	Countermeasure
P1	<p>Abnormality of room temperature thermistor (TH1)</p> <p>① The unit is in three-minute resume prevention mode if short/open of thermistor is detected. Abnormal if the unit does not reset normally after three minutes. (The unit returns to normal operation, if it has normally reset.)</p> <p>② Constantly detected during cooling, drying, and heating operation. Short: 90°C or more Open: -40°C or less</p>	<p>① Defective thermistor characteristics.</p> <p>② Contact failure of connector (CN20) on the indoor controller board. (Insert failure)</p> <p>③ Breaking of wire or contact failure of thermistor wiring.</p> <p>④ Defective indoor controller board.</p>	<p>①-③ Check resistance value of thermistor. 0°C15.0kΩ 10°C9.6kΩ 20°C6.3kΩ 30°C4.3kΩ 40°C3.0kΩ</p> <p>If you put force on (draw or bend) the lead wire with measuring resistance value of thermistor breaking of wire or contact failure can be detected.</p> <p>② Check contact failure of connector (CN20) on the indoor controller board. Refer to 9-7. Turn the power on again and check restart after inserting connector again.</p> <p>④ Check room temperature display on remote controller. Replace indoor controller board if there is abnormal difference with actual room temperature.</p> <p>Turn the power off, and on again to operate after check.</p>
P2	<p>Abnormality of pipe temperature thermistor/Liquid (TH2)</p> <p>① The unit is in three-minute resume prevention mode if short/open of thermistor is detected. Abnormal if the unit does not reset normally after three minutes. (The unit returns to normal operation, if it has normally reset.)</p> <p>② Constantly detected during cooling, drying, and heating (except defrosting) operation. Short: 90°C or more Open: -40°C or less</p>	<p>① Defective thermistor characteristics.</p> <p>② Contact failure of connector (CN21) on the indoor controller board. (Insert failure)</p> <p>③ Breaking of wire or contact failure of thermistor wiring.</p> <p>④ Defective refrigerant circuit is causing thermistor temperature of 90°C or more or -40°C or less.</p> <p>⑤ Defective indoor controller board.</p>	<p>①-③ Check resistance value of thermistor. For characteristics, refer to (P1) above.</p> <p>② Check contact failure of connector (CN21) on the indoor controller board. Refer to 9-7. Turn the power on and check restart after inserting connector again.</p> <p>④ Check pipe <liquid> temperature with remote controller in test run mode. If pipe <liquid> temperature is exclusively low (in cooling mode) or high (in heating mode), refrigerant circuit may have defective.</p> <p>⑤ Check pipe <liquid> temperature with remote controller in test run mode. If there is exclusive difference with actual pipe <liquid> temperature, replace indoor controller board.</p> <p>Turn the power off, and on again to operate after check.</p>
P4	<p>Abnormality of drain sensor (DS)</p> <p>① Suspensive abnormality, if short/open of thermistor is detected for 30 seconds continuously. Turn off compressor and indoor fan.</p> <p>② Short/open is detected for 30 seconds continuously during suspensive abnormality. (The unit returns to normal operation, if it has normally reset.)</p> <p>③ Detect the following condition.</p> <ul style="list-style-type: none"> • During cooling and drying operation. • In case that pipe <liquid> temperature - room temperature <-10deg (Except defrosting) • When pipe <liquid> temperature or room temperature is short/open temperature. • During drain pump operation. 	<p>① Defective thermistor characteristics</p> <p>② Contact failure of connector (CN31) on the indoor controller board. (Insert failure).</p> <p>③ Breaking of wire or contact failure of drain sensor wiring.</p> <p>④ Defective indoor controller board.</p>	<p>①-③ Check resistance value of thermistor. 0°C6.0kΩ 10°C3.9kΩ 20°C2.6kΩ 30°C1.8kΩ 40°C1.3kΩ</p> <p>② Check contact failure of connector (CN31) on the indoor controller board. Refer to 9-7. Turn the power on again and check restart after inserting connector again.</p> <p>④ Replace indoor controller board if drain pump operates with the line of drain sensor connector CN31-① and ② is short-circuited, and abnormality reappears.</p> <p>Turn the power off, and on again to operate after check.</p>
P5	<p>Malfunction of drain pump (DP)</p> <p>① Suspensive abnormality, if thermistor of drain sensor is let heat itself and temperature rises slightly. Turn off compressor and indoor fan.</p> <p>② Drain pump is abnormal if the condition above is detected during suspensive abnormality.</p> <p>③ Constantly detected during drain pump operation.</p>	<p>① Malfunction of drain pump</p> <p>② Defective drain Clogged drain pump Clogged drain pipe</p> <p>③ Attached drop of water at the drain sensor</p> <ul style="list-style-type: none"> • Drops of drain trickles from lead wire. • Clogged filter is causing wave of drain. <p>④ Defective indoor controller board.</p>	<p>① Check if drain-up machine works.</p> <p>② Check drain function.</p> <p>③ Check the setting of lead wire of drain sensor and check clogs of the filter.</p> <p>④ Replace indoor controller board if drain pump operates with the line of drain sensor connector CN31-① and ② is short-circuited and abnormality reappears. Refer to 9-7.</p> <p>Turn the power off, and on again to operate after check.</p>

Error Code	Meaning of error code and detection method	Cause	Countermeasure
P6	<p>Freezing/overheating protection is working</p> <p>① Freezing protection (Cooling mode) The unit is in six-minute resume prevention mode if pipe <liquid or condenser/evaporator> temperature stays under -15°C for three minutes, three minutes after the compressor started. Abnormal if it stays under -15°C for three minutes again within 16 minutes after six-minute resume prevention mode. <Frost prevention mode> If pipe <liquid or condenser-evaporator> temperature is 2°C or below when 16 minutes has passed after compressor starts operating, unit will start operating in frost prevention mode which stops compressor operation. After that, when pipe <liquid or condenser/evaporator> temperature stays 10°C or more for 3 minutes, frost prevention mode will be released and compressor will restart its operation.</p> <p>② Overheating protection (Heating mode) The units is in six-minute resume prevention mode if pipe <condenser / evaporator> temperature is detected as over 70°C after the compressor started. Abnormal if the temperature of over 70°C is detected again within 10 minutes after six-minute resume prevention mode.</p>	<p>(Cooling or drying mode)</p> <p>① Clogged filter (reduced airflow) ② Short cycle of air path ③ Low-load (low temperature) operation beyond the tolerance range ④ Defective indoor fan motor • Fan motor is defective. • Indoor controller board is defective.</p> <p>⑤ Defective outdoor fan control ⑥ Overcharge of refrigerant ⑦ Defective refrigerant circuit (clogs)</p> <p>(Heating mode)</p> <p>① Clogged filter (reduced airflow) ② Short cycle of air path ③ Over-load (high temperature) operation beyond the tolerance range ④ Defective indoor fan motor • Fan motor is defective. • Indoor controller board is defective.</p> <p>⑤ Defective outdoor fan control ⑥ Overcharge of refrigerant ⑦ Defective refrigerant circuit (clogs) ⑧ Bypass circuit of outdoor unit is defective.</p>	<p>(Cooling or drying mode)</p> <p>① Check clogs of the filter. ② Remove shields.</p> <p>④ Measure the resistance of fan motor's winding. Measure the output voltage of fan's connector (FAN) on the indoor controller board. *The indoor controller board should be normal when voltage of AC 220~240V is detected while fan motor is connected. Refer to 9-7. ⑤ Check outdoor fan motor. ⑥⑦ Check operating condition of refrigerant circuit.</p> <p>(Heating mode)</p> <p>① Check clogs of the filter. ② Remove shields.</p> <p>④ Measure the resistance of fan motor's winding. Measure the output voltage of fan's connector (FAN) on the indoor controller board. *The indoor controller board should be normal when voltage of AC 220~240V is detected while fan motor is connected. Refer to 9-7. ⑤ Check outdoor fan motor. ⑥~⑧ Check operating condition of refrigerant circuit.</p>
P8	<p>Abnormality of pipe temperature <Cooling mode> Detected as abnormal when the pipe temperature is not in the cooling range 3 minutes later of compressor start and 6 minutes later of the liquid or condenser/evaporator pipe is out of cooling range. Note 1) It takes at least 9 min. to detect. Note 2) Abnormality P8 is not detected in drying mode. Cooling range : -3 deg \geq (TH-TH1) TH: Lower temperature between: liquid pipe temperature (TH2) and condenser/evaporator temperature (TH5) TH1: Intake temperature</p> <p><Heating mode> When 10 seconds have passed after the compressor starts operation and the hot adjustment mode has finished, the unit is detected as abnormal when condenser/evaporator pipe temperature is not in heating range within 20 minutes.</p> <p>Note 3) It takes at least 27 minutes to detect abnormality. Note 4) It excludes the period of defrosting (Detection restarts when defrosting mode is over) Heating range : 3 deg \leq (TH5-TH1)</p>	<p>① Slight temperature difference between indoor room temperature and pipe <liquid or condenser / evaporator> temperature thermistor • Shortage of refrigerant • Disconnected holder of pipe <liquid or condenser / evaporator> thermistor • Defective refrigerant circuit</p> <p>② Converse connection of extension pipe (on plural units connection) ③ Converse wiring of indoor/outdoor unit connecting wire (on plural units connection) ④ Defective detection of indoor room temperature and pipe <condenser / evaporator> temperature thermistor ⑤ Stop valve is not opened completely.</p>	<p>①~④ Check pipe <liquid or condenser / evaporator> temperature with room temperature display on remote controller and outdoor controller circuit board. Pipe <liquid or condenser / evaporator> temperature display is indicated by setting SW2 of outdoor controller circuit board as follows.</p> <p>(Conduct temperature check with outdoor controller circuit board after connecting 'A-Control Service Tool(PAC-SK52ST)')</p> <p>②③ Check converse connection of extension pipe or converse wiring of indoor/outdoor unit connecting wire.</p>



Error Code	Meaning of error code and detection method	Cause	Countermeasure
P9	<p>Abnormality of pipe temperature thermistor / Condenser-Evaporator (TH5)</p> <p>① The unit is in three-minute resume protection mode if short/open of thermistor is detected. Abnormal if the unit does not get back to normal within three minutes. (The unit returns to normal operation, if it has normally reset.)</p> <p>② Constantly detected during cooling, drying, and heating operation (except defrosting) Short: 90°C or more Open: -40°C or less</p>	<p>① Defective thermistor characteristics</p> <p>② Contact failure of connector (CN29) on the indoor controller board. (Insert failure)</p> <p>③ Breaking of wire or contact failure of thermistor wiring.</p> <p>④ Temperature of thermistor is 90°C or more or -40°C or less caused by defective refrigerant circuit.</p> <p>⑤ Defective indoor controller board.</p>	<p>①-③ Check resistance value of thermistor. For characteristics, refer to (P1) above.</p> <p>② Check contact failure of connector (CN29) on the indoor controller board. Refer to 9-7. Turn the power on and check restart after inserting connector again.</p> <p>④ Operate in test run mode and check pipe <condenser / evaporator> temperature with outdoor controller circuit board. If pipe <condenser / evaporator> temperature is exclusively low (in cooling mode) or high (in heating mode), refrigerant circuit may have defective.</p> <p>⑤ Operate in test run mode and check pipe <condenser / evaporator> temperature with outdoor control circuit board. If there is exclusive difference with actual pipe <condenser / evaporator> temperature replace indoor controller board. There is no abnormality if none of above comes within the unit. Turn the power off and on again to operate.</p> <p>(In case of checking pipe temperature with outdoor controller circuit board, be sure to connect A-control service tool (PAC-SK52ST).)</p>
E0 or E4	<p>Remote controller transmission error(E0)/signal receiving error(E4)</p> <p>① Abnormal if main or sub remote controller can not receive normally any transmission from indoor unit of refrigerant address "0" for three minutes. (Error code : E0)</p> <p>② Abnormal if sub remote controller could not receive for any signal for two minutes. (Error code: E0)</p> <p>① Abnormal if indoor controller board can not receive normally any data from remote controller board or from other indoor controller board for three minutes. (Error code: E4)</p> <p>② Indoor controller board cannot receive any signal from remote controller for two minutes. (Error code: E4)</p>	<p>① Contact failure at transmission wire of remote controller</p> <p>② All remote controllers are set as "sub" remote controller. In this case, E0 is displayed on remote controller, and E4 is displayed at LED (LED1, LED2) on the outdoor controller circuit board.</p> <p>③ Mis-wiring of remote controller.</p> <p>④ Defective transmitting receiving circuit of remote controller</p> <p>⑤ Defective transmitting receiving circuit of indoor controller board of refrigerant address "0".</p> <p>⑥ Noise has entered into the transmission wire of remote controller.</p>	<p>① Check disconnection or looseness of indoor unit or transmission wire of remote controller.</p> <p>② Set one of the remote controllers "main". If there is no problem with the action above.</p> <p>③ Check wiring of remote controller.</p> <ul style="list-style-type: none"> • Total wiring length: max.500m (Do not use cable × 3 or more) • The number of connecting indoor units: max.16units • The number of connecting remote controller: max.2units <p>When it is not the above-mentioned problem of</p> <p>①-③</p> <p>④ Diagnose remote controllers.</p> <p>a) When "RC OK" is displayed, Remote controllers have no problem. Put the power off, and on again to check. If abnormality generates again, replace indoor controller board.</p> <p>b) When "RC NG" is displayed, Replace remote controller.</p> <p>c) When "RC E3" is displayed,</p> <p>d) When "ERC 00-06" is displayed, [c),d)→Noise may be causing abnormality.]</p> <p>* If the unit is not normal after replacing indoor controller board in group control, indoor controller board of address "0" may be abnormal.</p>
E3 or E5	<p>Remote controller transmission error(E3)/signal receiving error(E5)</p> <p>① Abnormal if remote controller could not find blank of transmission path for six seconds and could not transmit. (Error code: E3)</p> <p>② Remote controller receives transmitted data at the same time, compares the data, and when detecting it, judges different data to be abnormal 30 continuous times. (Error code: E3)</p> <p>① Abnormal if indoor controller board could not find blank of transmission path. (Error code: E5)</p> <p>② Indoor controller board receives transmitted data at the same time, compares the data, and when detecting it, judges different data to be abnormal 30 continuous times. (Error code: E5)</p>	<p>① Two remote controller are set as "main." (In case of 2 remote controllers)</p> <p>② Remote controller is connected with two indoor units or more.</p> <p>③ Repetition of refrigerant address.</p> <p>④ Defective transmitting receiving circuit of remote controller.</p> <p>⑤ Defective transmitting receiving circuit of indoor controller board.</p> <p>⑥ Noise has entered into transmission wire of remote controller.</p>	<p>① Set a remote controller to main, and the other to sub.</p> <p>② Remote controller is connected with only one indoor unit.</p> <p>③ The address changes to a separate setting.</p> <p>④-⑥ Diagnose remote controller.</p> <p>a) When "RC OK" is displayed, remote controllers have no problem. Put the power off, and on again to check. When becoming abnormal again, replace indoor controller board.</p> <p>b) When "RC NG" is displayed, replace remote controller.</p> <p>c) When "RC E3" or "ERC 00-66" is displayed, noise may be causing abnormality.</p>



Error Code	Meaning of error code and detection method	Cause	Countermeasure
E6	Indoor/outdoor unit communication error (Signal receiving error) ① Abnormal if indoor controller board cannot receive any signal normally for six minutes after putting the power on. ② Abnormal if indoor controller board cannot receive any signal normally for three minutes. ③ Consider the unit abnormal under the following condition: When two or more indoor units are connected to one outdoor unit, indoor controller board cannot receive a signal for three minutes from outdoor controller circuit board, a signal which allows outdoor controller circuit board to transmit signals.	① Contact failure, short circuit or, mis-wiring (converse wiring) of indoor/outdoor unit connecting wire ② Defective transmitting receiving circuit of indoor controller board ③ Defective transmitting receiving circuit of indoor controller board ④ Noise has entered into indoor/outdoor unit connecting wire.	* Check LED display on the outdoor control circuit board. (Connect A-control service tool, PAC-SK52ST.) Refer to EA-EC item if LED displays EA-EC. ① Check disconnection or looseness of indoor/outdoor unit connecting wire of indoor unit or outdoor unit. Check all the units in case of twin triple indoor unit system. ②-④ Turn the power off, and on again to check. If abnormality generates again, replace indoor controller board or outdoor controller circuit board. * Other indoor controller board may have defective in case of twin triple indoor unit system.
E7	Indoor/outdoor unit communication error (Transmitting error) Abnormal if "1" receiving is detected 30 times continuously though indoor controller board has transmitted "0".	① Defective transmitting receiving circuit of indoor controller board ② Noise has entered into power supply. ③ Noise has entered into outdoor control wire.	①-③ Turn the power off, and on again to check. If abnormality generates again, replace indoor controller board.
Fb	Abnormality of indoor controller board Abnormal if data cannot be normally read from the nonvolatile memory of the indoor controller board.	① Defective indoor controller board.	① Replace indoor controller board.
E1 or E2	Abnormality of remote controller control board ① Abnormal if data cannot be normally read from the nonvolatile memory of the remote controller control board. (Error code: E1) ② Abnormal if the clock function of remote controller cannot be normally operated. (Error code: E2)	① Defective remote controller.	① Replace remote controller.
PA (2502) (2500)	Forced compressor stop (due to water leakage abnormality) ① When the intake temperature subtracted with liquid pipe temperature is less than -10°C, drain sensor is detected whether it is soaked in the water or not at the interval of 90 seconds. (Drain pump will start operating when the drain sensor is detected to be soaked in the water.) ② The unit has a water leakage abnormality when the following conditions, a and b, are satisfied while the above-mentioned detection is performed. a) The drain sensor is detected to be soaked in the water 10 times in a row. b) The intake temperature subtracted with liquid pipe temperature is detected to be less than -10°C for a total of 30 minutes. (When the drain sensor is detected to be NOT soaked in the water, the detection record of a and b will be cleared.) ③ The drain sensor detection is performed in operations other than cooling. (When the unit stops operating, during heating or fan operation, when the unit stops because of some abnormality) *Once the water leakage abnormality is detected, abnormality state will not be released until the main power is reset.	① Drain pump trouble ② Drain defective • Drain pump clogging • Drain pipe clogging ③ Open circuit of drain sensor side heater ④ Contact failure of drain sensor connector ⑤ Dew condensation on drain sensor • Drain water descends along lead wire. • Drain water waving due to filter clogging. ⑥ Extension piping connection difference at twin, triple, quadruple system. ⑦ Mis-wiring of indoor/ outdoor connecting at twin, triple, quadruple system. ⑧ Room temperature thermistor / liquid pipe temperature thermistor detection is defective.	① Check the drain pump. ② Please confirm whether water can be drained. ③ Confirm the resistance of the drain sensor. ④ Check the connector contact failure. ⑤ Check the drain sensor leadwire mounted. Check the filter clogging. ⑥ Check the piping connection. ⑦ Check the indoor/ outdoor connecting wires. ⑧ Check the room temperature display of remote controller. Check the indoor liquid pipe temperature display of outdoor controller board.

9-4. TROUBLESHOOTING BY INFERIOR PHENOMENA

Note: Refer to the manual of outdoor unit for the detail of remote controller.



Phenomena	Cause	Countermeasure
(1)LED2 on indoor controller board is off.	<ul style="list-style-type: none"> • When LED1 on indoor controller board is also off. <p>① Power supply of rated voltage is not supplied to outdoor unit.</p> <p>② Defective outdoor controller circuit board.</p> <p>③ Power supply of 220~240V is not supplied to indoor unit.</p> <p>④ Defective indoor power board.</p> <p>⑤ Defective indoor controller board.</p> <p>(For the separate indoor/outdoor unit power supply system)</p> <p>① Power supply of 220~240V AC is not supplied to indoor unit.</p> <p>② The connectors of the optional replacement kit are not used.</p> <p>③ Defective indoor controller board.</p> <p>④ Defective indoor power board.</p>	<p>① Check the voltage of outdoor power supply terminal block (L, N) or (L₃, N).</p> <ul style="list-style-type: none"> • When AC 220~240V is not detected. Check the power wiring to outdoor unit and the breaker. • When AC 220~240V is detected. —Check ② (below). <p>② Check the voltage between outdoor terminal block S1 and S2.</p> <ul style="list-style-type: none"> • When AC 220~240V is not detected. Check the fuse on outdoor controller circuit board. Check the wiring connection. • When AC 220~240V is detected. —Check ③ (below). <p>③ Check the voltage between indoor terminal block S1 and S2.</p> <ul style="list-style-type: none"> • When AC 220~240V is not detected. Check indoor/outdoor unit connecting wire for mis-wiring. • When AC 220~240V is detected. —Check ④ (below). <p>④ Check voltage output from CN2S on indoor power board (DC13.1V). Refer to 9-7-2.</p> <ul style="list-style-type: none"> • When no voltage is output. Check the wiring connection. • When output voltage is between DC12.5V and DC13.7V. —Check ⑤ (below). <p>⑤ Check the wiring connection between indoor controller board and indoor power board. Check the fuse on indoor controller board. If no problems are found, indoor controller board is defective.</p>
	<ul style="list-style-type: none"> • When LED1 on indoor controller board is lit. <p>① Mis-setting of refrigerant address for outdoor unit (There is no unit corresponding to refrigerant address "0".)</p>	<p>① Reconfirm the setting of refrigerant address for outdoor unit. Set the refrigerant address to "0". (For grouping control system under which 2 or more outdoor units are connected, set one of the units to "0".) Set refrigerant address using SW1 (3-6) on outdoor controller circuit board.</p>

Note: Refer to the manual of outdoor unit for the detail of remote controller.

Phenomena	Cause	Countermeasure
(2)LED2 on indoor controller board is blinking.	<ul style="list-style-type: none"> • When LED1 on indoor controller board is also blinking. Connection failure of indoor/outdoor unit connecting wire • When LED1 is lit. ① Mis-wiring of remote controller wires Under twin triple indoor unit system, 2 or more indoor units are wired together. ② Refrigerant address for outdoor unit is wrong or not set. Under grouping control system, there are some units whose refrigerant address is 0. ③ Short-cut of remote controller wires ④ Defective remote controller 	<p>Check indoor/outdoor unit connecting wire for connection failure.</p> <ul style="list-style-type: none"> ① Check the connection of remote controller wires in case of twin triple indoor unit system. When 2 or more indoor units are wired in one refrigerant system, connect remote controller wires to one of those units. ② Check the setting of refrigerant address in case of grouping control system. If there are some units whose refrigerant addresses are 0 in one group, set one of the units to 0 using SW1 (3-6) on outdoor controller circuit board. ③④ Remove remote controller wires and check LED2 on indoor controller board. <ul style="list-style-type: none"> • When LED2 is blinking, check the short-cut of remote controller wires. • When LED2 is lit, connect remote controller wires again and: if LED2 is blinking, remote controller is defective; if LED2 is lit, connection failure of remote controller terminal block etc. has returned to normal.
(3)Upward/downward vane performance failure	<ul style="list-style-type: none"> ① The vane is not downward during defrosting and heat preparation and when the thermostat is OFF in HEAT mode. (Working of COOL protection function) ② Vane motor does not rotate. <ul style="list-style-type: none"> • Defective vane motor • Breaking of wire or connection failure of connector • Up/down vane setting is "No vanes". ③ Upward/downward vane does not work. <ul style="list-style-type: none"> • The vane is set to fixed position. 	<ul style="list-style-type: none"> ① Normal operation (The vane is set to horizontal regardless of remote control.) ② Check ② (left). <ul style="list-style-type: none"> • Check the vane motor. (Refer to "How to check the parts".) • Check for breaking of wire or connection failure of connector. • Check "Up/down vane setting". (Unit function selection by remote controller). ③ Normal operation (Each connector on vane motor side is disconnected.)
(4)Receiver for wireless remote controller	<ul style="list-style-type: none"> ① Weak batteries of wireless remote controller. ② Contact failure of connector (CNB) on wireless remote controller board. (Insert failure) ③ Contact failure of connector (CN90) on indoor controller board. (Insert failure) ④ Contact failure of connector between wireless remote controller board and indoor controller board. 	<ul style="list-style-type: none"> ① Replace batteries of wireless remote controller. ②~④ Check contact failure of each connector. If no problems are found of connector, replace indoor controller board. When the same trouble occurs even if indoor controller board is replaced, replace wireless remote controller board.

9-5. EMERGENCY OPERATION

9-5-1. When wireless remote controller troubles or its battery is exhausted

- Emergency operation is available in such a case using emergency operation switch equipped next to the receiver of indoor unit.
 - To start operation
 - Cooling Operation.....Press  (Cooling) switch.
 - Heating Operation.....Press  (Heating) switch.
- ※When the unit starts operating, the power lamp is lit.

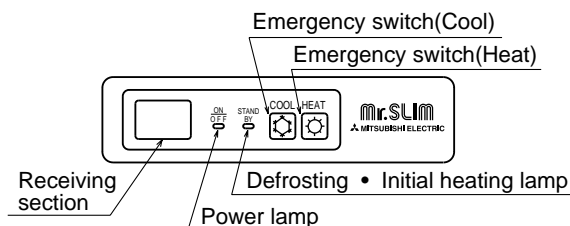

※Emergency operation will be performed as follows.

Mode	Cooling	Heating
Set temperature	24°C	24°C
Fan speed	High	High
Airflow direction	Horizontal (30deg)	Downward (70deg)

- To stop operation
 - Press either emergency operation switch (cooling/heating).

9-5-2. When wired remote controller or indoor unit micro computer troubles

- If there is not any other wrong when trouble occurs, emergency operation starts as the indoor controller board switch (SWE) is set to ON.
During the emergency operation the indoor unit is as follows;
 - Indoor fan high speed operation
- When emergency operating for COOL or HEAT, setting of the switch (SWE) in the indoor controller board and outdoor unit emergency operation are necessary.
- Check items and notices as the emergency operation
 - Emergency operation cannot be used as follows;
 - When the outdoor unit is something wrong.
 - When the indoor fan is something wrong.
 - When drain over flow protected operation is detected during self-diagnosis. (Error code : P5)
 - Emergency operation will be serial operation by the power supply ON/OFF.
ON/OFF or temperature, etc. adjustment is not operated by the remote controller.
 - Do not operate for a long time as cold air is blown when the outdoor unit starts defrosting operation during heat emergency operation.
 - Cool emergency operation must be within 10 hours at most. It may cause heat exchanger frosting in the indoor unit.
 - After completing the emergency operation, return the switch setting, etc. in former state.
 - Since vane does not work at emergency operation, position the vane manually and slowly.

9-6. HOW TO CHECK THE PARTS

PKH-P35GALH, PKH-P50GALH

PKA-RP35GAL, PKA-RP50GAL

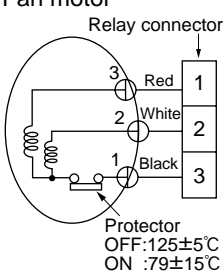
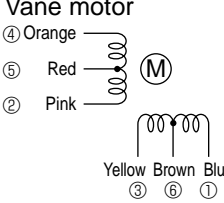
Parts name	Check points									
Room temperature thermistor (TH1) Pipe temperature thermistor (TH2) Condenser/evaporator temperature thermistor (TH5)	Disconnect the connector then measure the resistance using a tester. (Surrounding temperature 10°C ~30°C)									
	<table border="1"> <thead> <tr> <th>Normal</th> <th>Abnormal</th> </tr> </thead> <tbody> <tr> <td>4.3kΩ~9.6kΩ</td> <td>Open or short</td> </tr> </tbody> </table> (Refer to <Thermistor Characteristic graph> for a detail.)	Normal	Abnormal	4.3kΩ~9.6kΩ	Open or short					
Normal	Abnormal									
4.3kΩ~9.6kΩ	Open or short									
Fan motor 	Measure the resistance between the terminals using a tester. (Winding temperature 20°C)									
	<table border="1"> <thead> <tr> <th>Motor terminal or Relay connector</th> <th>Normal</th> <th>Abnormal</th> </tr> </thead> <tbody> <tr> <td>Red-Black</td> <td>120.5Ω</td> <td rowspan="2">Open or short</td> </tr> <tr> <td>White-Black</td> <td>111.3Ω</td> </tr> </tbody> </table>	Motor terminal or Relay connector	Normal	Abnormal	Red-Black	120.5Ω	Open or short	White-Black	111.3Ω	
Motor terminal or Relay connector	Normal	Abnormal								
Red-Black	120.5Ω	Open or short								
White-Black	111.3Ω									
Vane motor 	Measure the resistance between the terminals using a tester. (Surrounding temperature 20°C ~30°C)									
	<table border="1"> <thead> <tr> <th>Connector</th> <th>Normal</th> <th>Abnormal</th> </tr> </thead> <tbody> <tr> <td>Brown-Yellow</td> <td rowspan="4">186~214Ω</td> <td rowspan="4">Open or short</td> </tr> <tr> <td>Brown-Blue</td> </tr> <tr> <td>Red-Orange</td> </tr> <tr> <td>Red-Pink</td> </tr> </tbody> </table>	Connector	Normal	Abnormal	Brown-Yellow	186~214Ω	Open or short	Brown-Blue	Red-Orange	Red-Pink
Connector	Normal	Abnormal								
Brown-Yellow	186~214Ω	Open or short								
Brown-Blue										
Red-Orange										
Red-Pink										
Heater (Only PKH)	Measure the resistance of each heater element by using a tester.									
	<table border="1"> <thead> <tr> <th>Normal</th> <th>Abnormal</th> </tr> </thead> <tbody> <tr> <td>72Ω 800W 240V</td> <td>Open or short</td> </tr> </tbody> </table>	Normal	Abnormal	72Ω 800W 240V	Open or short					
Normal	Abnormal									
72Ω 800W 240V	Open or short									
Contactor (for heater) (Only PKH)	Measure the resistance between the terminals using a tester.									
	<table border="1"> <thead> <tr> <th>Normal</th> <th>Abnormal</th> </tr> </thead> <tbody> <tr> <td>6 (88H) 1 160Ω</td> <td>Open or short</td> </tr> </tbody> </table>	Normal	Abnormal	6 (88H) 1 160Ω	Open or short					
Normal	Abnormal									
6 (88H) 1 160Ω	Open or short									

<Thermistor Characteristic graph>

Thermistor for lower temperature

Room temperature thermistor(TH1)
Pipe temperature thermistor(TH2)
Condenser/evaporator temperature thermistor(TH5)

Thermistor $R_0=15k\Omega \pm 3\%$

Fixed number of $B=3480 \pm 2\%$

$$R_t = 15 \exp \left\{ 3480 \left(\frac{1}{273+t} - \frac{1}{273} \right) \right\}$$

0°C	15kΩ
10°C	9.6kΩ
20°C	6.3kΩ
25°C	5.4kΩ
30°C	4.3kΩ
40°C	3.0kΩ

< Thermistor for lower temperature >

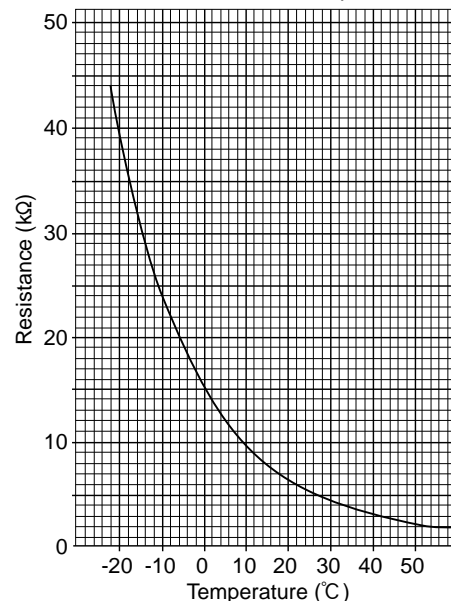

9-7. TEST POINT DIAGRAM

9-7-1. Indoor controller board PKA-RP35GAL PKH-P35GALH PKA-RP50GAL PKH-P50GALH

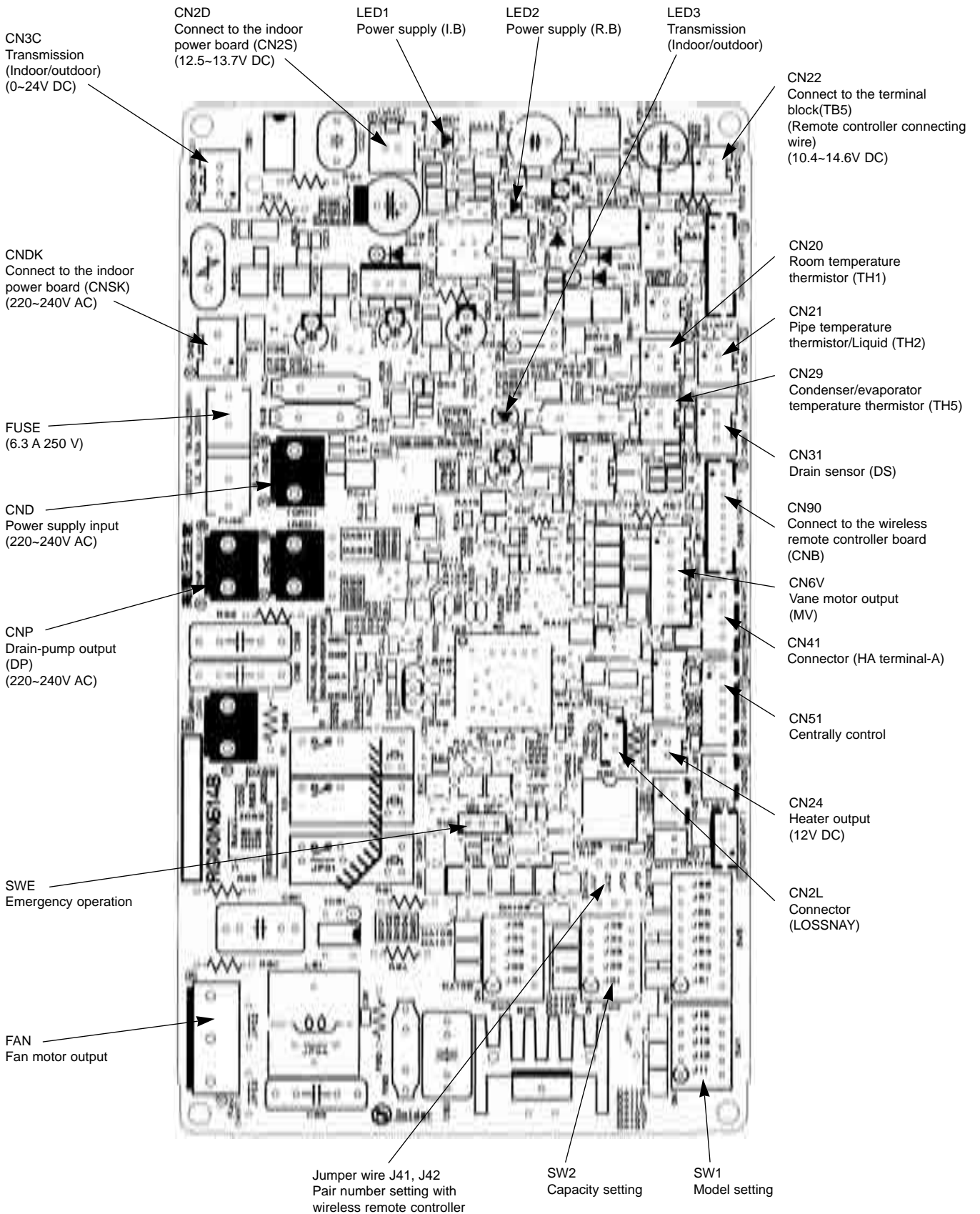

9-7-2. Indoor power board

PKA-RP35GAL PKH-P35GALH

PKA-RP50GAL PKH-P50GALH

CN2S

Connect to the indoor controller board (CN2D)
Between ① to ③ 12.6-13.7V DC (Pin① (+))

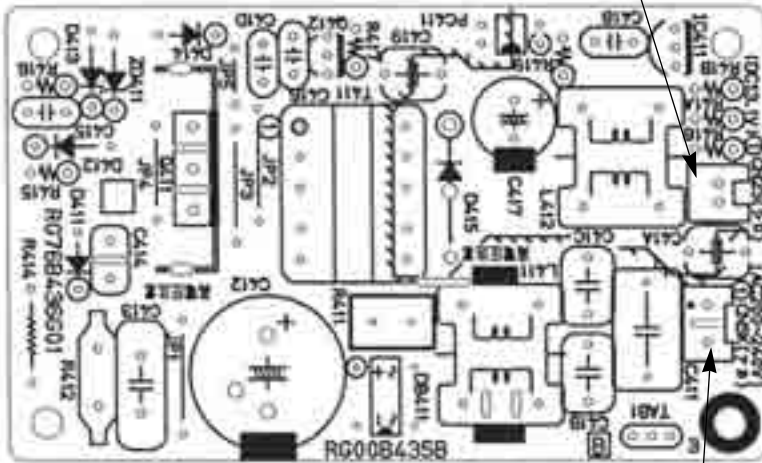

CNSK

Connect to the indoor controller board
(CNDK)
Between ① to ③ 220-240V AC







9-8. FUNCTIONS OF DIP SWITCH AND JUMPER WIRE

Each function is controlled by the dip switch and the jumper wire on control p.c. board.

SW1 and SW2 are equipped only for service parts.

Model setting and capacity setting are memorized in the nonvolatile memory of the control p.c. board of the unit.

(Marks in the table below) Jumper wire (○ : Short × : Open)

Jumper wire	Functions	Setting by the dip switch and jumper wire	Remarks																	
SW1	Model settings	For service board 																		
SW2	Capacity settings	<table border="1"> <thead> <tr> <th>Models</th> <th>Service board</th> </tr> </thead> <tbody> <tr> <td>PKA-RP35GAL PKH-P35GALH</td> <td></td> </tr> <tr> <td>PKA-RP50GAL PKH-P50GALH</td> <td></td> </tr> </tbody> </table>	Models	Service board	PKA-RP35GAL PKH-P35GALH		PKA-RP50GAL PKH-P50GALH													
Models	Service board																			
PKA-RP35GAL PKH-P35GALH																				
PKA-RP50GAL PKH-P50GALH																				
J41 J42	Pair number setting with wireless remote controller	<table border="1"> <thead> <tr> <th rowspan="2">Wireless remote controller setting</th> <th colspan="2">Control PCB setting</th> </tr> <tr> <th>J41</th> <th>J42</th> </tr> </thead> <tbody> <tr> <td>0</td> <td>○</td> <td>○</td> </tr> <tr> <td>1</td> <td>×</td> <td>○</td> </tr> <tr> <td>2</td> <td>○</td> <td>×</td> </tr> <tr> <td>3 ~ 9</td> <td>×</td> <td>×</td> </tr> </tbody> </table>	Wireless remote controller setting	Control PCB setting		J41	J42	0	○	○	1	×	○	2	○	×	3 ~ 9	×	×	<p><Settings at time of factory shipment> Wireless remote controller: 0 Control PCB: ○ (for both J41 and J42) Four pair number settings are supported. The pair number settings of the wireless remote controller and indoor control PCB (J41/J42) are given in the table on the left. ('×' in the table indicates the jumper line is disconnected.)</p>
Wireless remote controller setting	Control PCB setting																			
	J41	J42																		
0	○	○																		
1	×	○																		
2	○	×																		
3 ~ 9	×	×																		
JP1	Unit type setting	<table border="1"> <thead> <tr> <th>Model</th> <th>JP1</th> </tr> </thead> <tbody> <tr> <td>Without TH5</td> <td>○</td> </tr> <tr> <td>With TH5</td> <td>×</td> </tr> </tbody> </table>	Model	JP1	Without TH5	○	With TH5	×	There is no jumper (JP1) because these models have the cond./eva. temperature thermistor (TH5).											
Model	JP1																			
Without TH5	○																			
With TH5	×																			
JP3	Indoor controller board type setting	<table border="1"> <thead> <tr> <th>Indoor controller board type</th> <th>JP3</th> </tr> </thead> <tbody> <tr> <td>Factory shipment</td> <td>×</td> </tr> <tr> <td>Service parts</td> <td>○</td> </tr> </tbody> </table>	Indoor controller board type	JP3	Factory shipment	×	Service parts	○												
Indoor controller board type	JP3																			
Factory shipment	×																			
Service parts	○																			

**PKH-P35GALH, PKH-P50GALH
PKA-RP35GAL, PKA-RP50GAL**

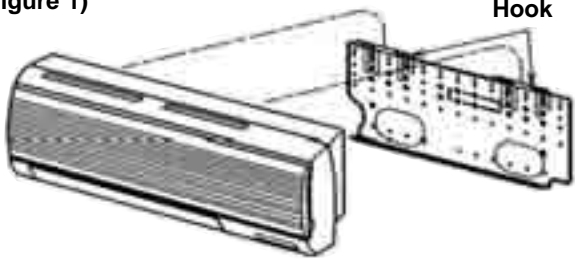
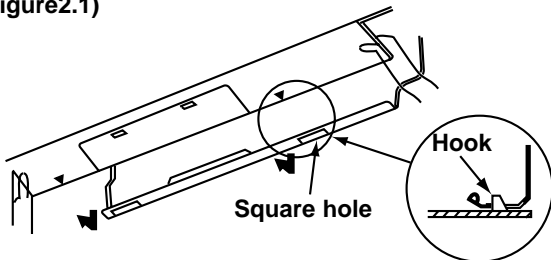
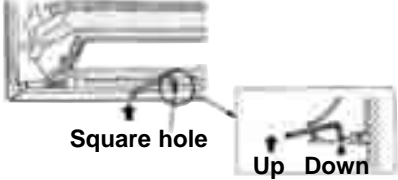
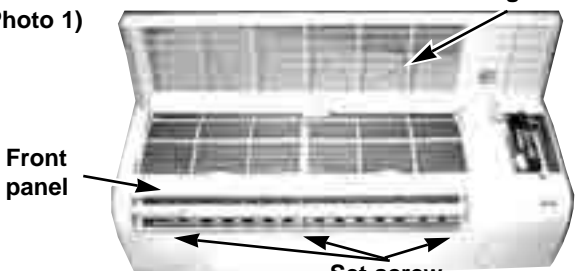
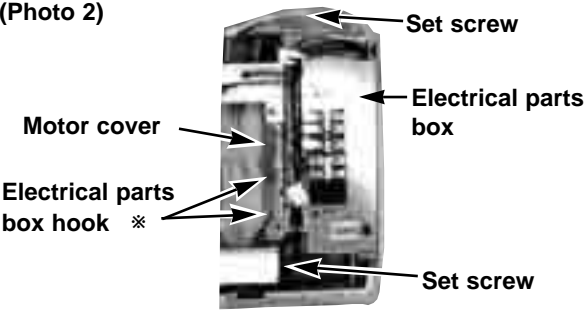
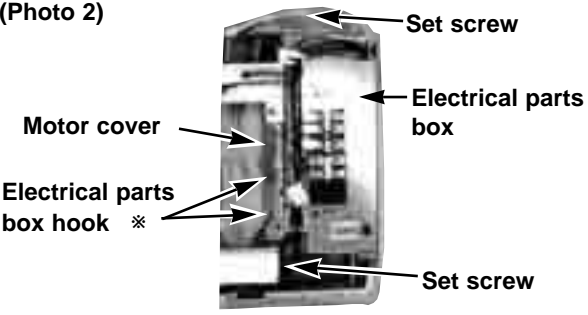
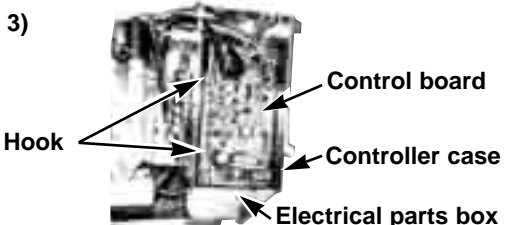
OPERATION PROCEDURE	PHOTOS & ILLUSTRATION
<p>1. REMOVE THE LOWER SIDE OF THE INDOOR UNIT FROM THE INSTALLATION PLATE.</p> <p>(1) Remove the left / right corner box of the indoor unit.</p> <p>(2) Hold and pull down the lower and both ends of the indoor unit, and remove the ▼ section from the square hole. (Refer to the figure 2.1)</p> <p>Or remove the front panel and push the ▼ section down by using hexagonal wrench ,etc. from the front side. (Refer to the figure 2.2).</p> <p>(3) Unhook the top of the indoor unit from the back plate catch.</p>	<p>(Figure 1)</p>  <p>Hook</p> <p>(Figure2.1)</p>  <p>Square hole</p> <p>Hook</p>
<p>(Figure 2.2)</p>  <p>Square hole</p> <p>Up Down</p> <p>2. REMOVING THE FRONT PANEL.</p> <p>(1) Open the front grille.</p> <p>(2) Remove the terminal block cover with a screw.</p> <p>(3) Remove the screw 3caps then remove the set 3screws.</p> <p>(4) After removing the lower side of the front panel a little, remove it as pulling toward upper.</p>	<p>(Figure 3)</p>  <p>Terminal block cover</p> <p>(Photo 1)</p>  <p>Front grille</p> <p>Front panel</p> <p>Set screw</p>
<p>3. REMOVING THE INDOOR CONTROLLER BOARD.</p> <p>(1) Remove the terminal block cover.</p> <p>(2) Remove the front panel. (see the photo 1)</p> <p>(3) Remove the electrical parts box(2screws).</p> <p>(4) Remove the electrical parts box cover(1screw).</p> <p>(5) Disconnect the connector on the controller board and remove the controller board by Pulling up the hook of the controller case.</p> <p>※ To smooth works, hang the side hooks of the electrical parts box on the hook of the motor cover. (see the photo 3)</p>	<p>(Photo 2)</p>  <p>Set screw</p> <p>Motor cover</p> <p>Electrical parts box</p> <p>Electrical parts box hook ※</p> <p>Set screw</p> <p>(Photo 3)</p>  <p>Hook</p> <p>Control board</p> <p>Controller case</p> <p>Electrical parts box</p>

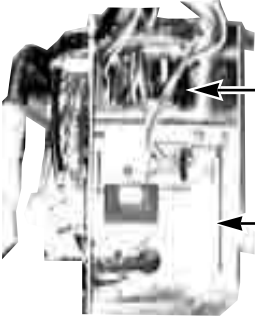
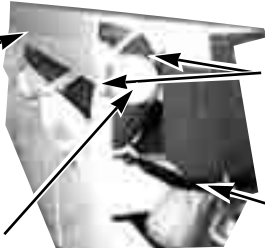
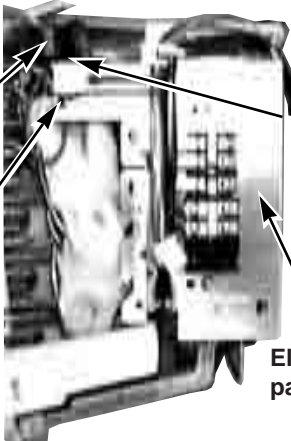
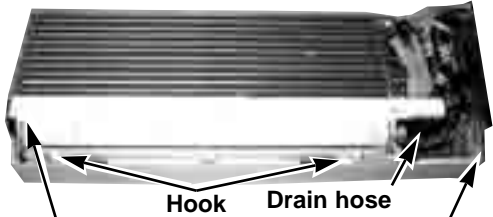
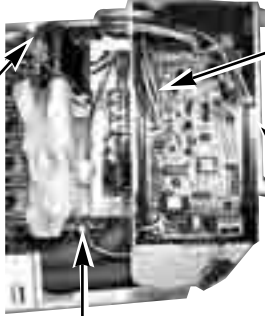

OPERATION PROCEDURE	PHOTOS & ILLUSTRATION
<p>4. REMOVING THE POWER BOARD</p> <ol style="list-style-type: none"> (1) Remove the front panel.(see the photo 1) (2) Remove the electrical parts box(2screws).(see the photo 2) (3) Disconnect the whole connector in the control board. (4) After lifting the controller case with pressing it's convex section, remove the controller case and the control board simultaneously.(see the photo 3) (5) Disconnect the connector in the power board. (6) Remove the power board. 	<p>(Photo 4)</p>  <p>Power board</p> <p>Electrical parts box</p>
<p>5. REMOVING THE VANE MOTOR</p> <ol style="list-style-type: none"> (1) Disconnect the connector CN6V on the indoor controller board. (2) Remove the 2screws of the vane motor, disconnect the lead wire and remove the vane motor from the shaft. 	<p>(Photo 5)</p>  <p>Nozzle assemble</p> <p>Set screws</p> <p>Lead wire</p> <p>Vane motor</p>
<p>6. REMOVING THE THERMISTOR</p> <ol style="list-style-type: none"> (1) Removing the room temperature thermistor TH1. <ol style="list-style-type: none"> ①Disconnect the connector CN20<red> on the indoor controller board. ②Remove the room temperature thermistor from the holder. (2) Removing the pipe temperature thermistor TH2. <ol style="list-style-type: none"> ①Disconnect the connector CN21<white> on the controller board. ②Remove the pipe temperature thermistor with set to the pipe. (3) Removing the indoor coil temperature thermistor TH5. <ol style="list-style-type: none"> ①Disconnect the connector CN29<black> on the indoor controller board. ②Remove the gas pipe thermistor with set to the pipe. 	<p>(Photo 6)</p>  <p>Pipe temperature thermistor (TH2)</p> <p>Room temperature thermistor (TH1)</p> <p>Condenser /evaporator temperature thermistor (TH5)</p> <p>Electrical parts box</p>
<p>7. REMOVING THE NOZZLE ASSEMBLY</p> <ol style="list-style-type: none"> (1) Disconnect the connector CN6V on the controller board. (2) Disconnect the lead wire of the vane motor. (3) Remove the corner cover. (4) Pull the drain hose out from the nozzle assemble. (5) Unhook the hook of the lower nozzle assemble and pull the nozzle assemble toward you,then remove the nozzle assemble by sliding it down. 	<p>(Photo 7)</p>  <p>Hook</p> <p>Drain hose</p> <p>Nozzle assemble</p> <p>Corner cover</p>
<p>8. REMOVING THE ELECTRICAL PARTS BOX</p> <ol style="list-style-type: none"> (1) Remove the terminal block cover. (2) Disconnect the connector <yellow> of the wireless remote controller board. (3) Remove the front panel.(see the photo 1) (4) Disconnect the vane motor connector. (5) Disconnect the fan motor connector from the fan motor. (6) Disconnect the connector <yellow> of the heater. (only PKH). (7) Remove the liquid(TH2) / gas(TH5) pipe thermistors.(see the photo 6) (8) Remove the electrical parts box (2screws). 	<p>(Photo 8)</p>  <p>Vane motor connector</p> <p>Pipe temperature thermistor</p> <p>Fan motor connector</p> <p>Electrical parts box</p>

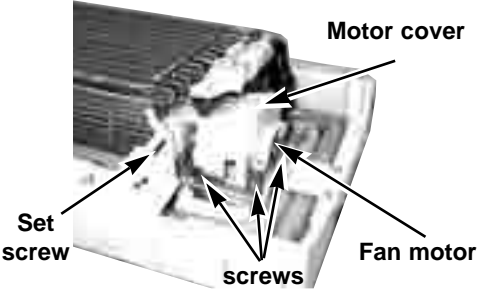
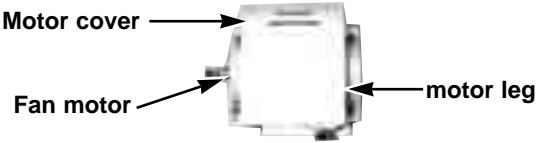
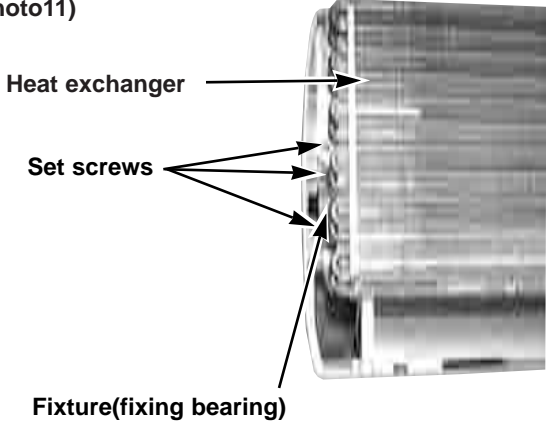
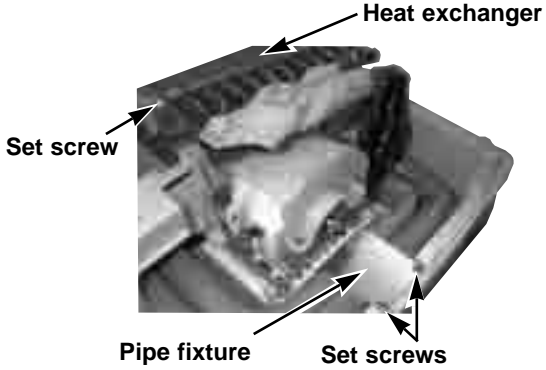
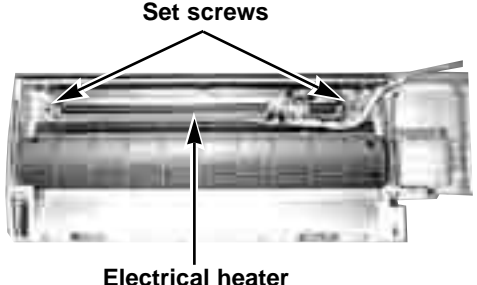

OPERATION PROCEDURE	PHOTOS & ILLUSTRATION
<p>9. REMOVING THE FAN MOTOR.</p> <ol style="list-style-type: none">(1) Remove the terminal block cover.(2) Disconnect the connector <yellow> of the wireless remote controller board.(3) Remove the front panel.(see the photo 1)(4) Remove the electrical parts box.(see the photo 8)(5) Remove the nozzle assemble.(see the photo 7)(6) Remove the fan motor leg fixing 3screws.(7) Unscrew the set screws using by alankey and remove it by sliding the fan motor to right.(8) Remove the 4screws and remove the motor cover from the fan motor leg.	<p>(Photo 9)</p>  <p>(Photo 10)</p> 
<p>10. REMOVING THE LINE FLOW FAN</p> <ol style="list-style-type: none">(1) Remove the terminal block cover.(2) Remove the front panel.(see the photo 1)(3) Remove the electrical parts box.(see the photo 8)(4) Remove the nozzle assembly.(see the photo 7)(5) Remove the fan motor.(see the photo 9)(6) Remove the pipe fixture with 2screws.(see the photo12)(7) Remove the left / right screws of the heat exchanger and pull the left-hand side up.(8) Remove the 2screws by sliding it toward you remove the fixture(fixing bearing). <p>※ The fan motor is removable first , when the fan removing is hard.</p> <p>※ When resetting the fan to the fan motor. Locate and fix the shaft after installing the fan.</p>	<p>(Photo11)</p> 
<p>11. REMOVING THE HEAT EXCHANGER</p> <ol style="list-style-type: none">(1) Remove the terminal block cover.(2) Disconnect the connector <yellow> of the wireless remote controller board.(3) Remove the front panel.(see the photo 1)(4) Remove the electrical parts box.(see the photo 8)(5) Remove the corner box.(6) Remove the nozzle assemble.(see the photo 7)(7) Remove the 2screws and the pipe fixture.(8) Remove the 2screws and heat exchanger.	<p>(Photo 12)</p> 
<p>12. REMOVING ELECTRICAL HEATER (PKH-P35/50GALH only)</p> <ol style="list-style-type: none">(1) Remove the terminal block cover.(2) Disconnect the connector <yellow> for the wireless remote controller.(3) Remove the front panel.(see the photo 1)(4) Remove the electrical parts box.(see the photo 8)(5) Remove the nozzle assembly.(see the photo 7)(6) Remove the heat exchanger.(see the photo 12)(7) Remove the 2screws and electrical heater.	<p>(Photo 13)</p> 

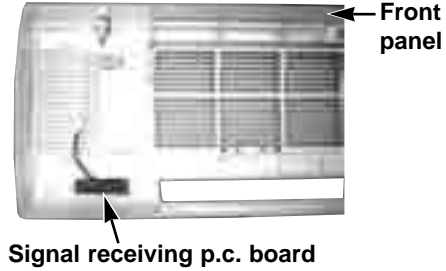

OPERATION PROCEDURE	PHOTOS & ILLUSTRATION
<p>13. REMOVING the SIGNAL RECEIVING P.C. BOARD</p> <ol style="list-style-type: none">(1) Remove the terminal block cover.(2) Disconnect the connector <yellow> for the wireless remote controller.(3) Remove the front panel.(see the photo 1)(4) Remove the 2screws and signal receiving p.c. board cover.(5) Remove the signal receiving p.c. board.	<p>(Photo 14)</p>  <p>(Photo 15)</p> 

ELECTRICAL PARTS

PKH-P35GALH, PKA-RP35GAL

PKH-P50GALH, PKA-RP50GAL

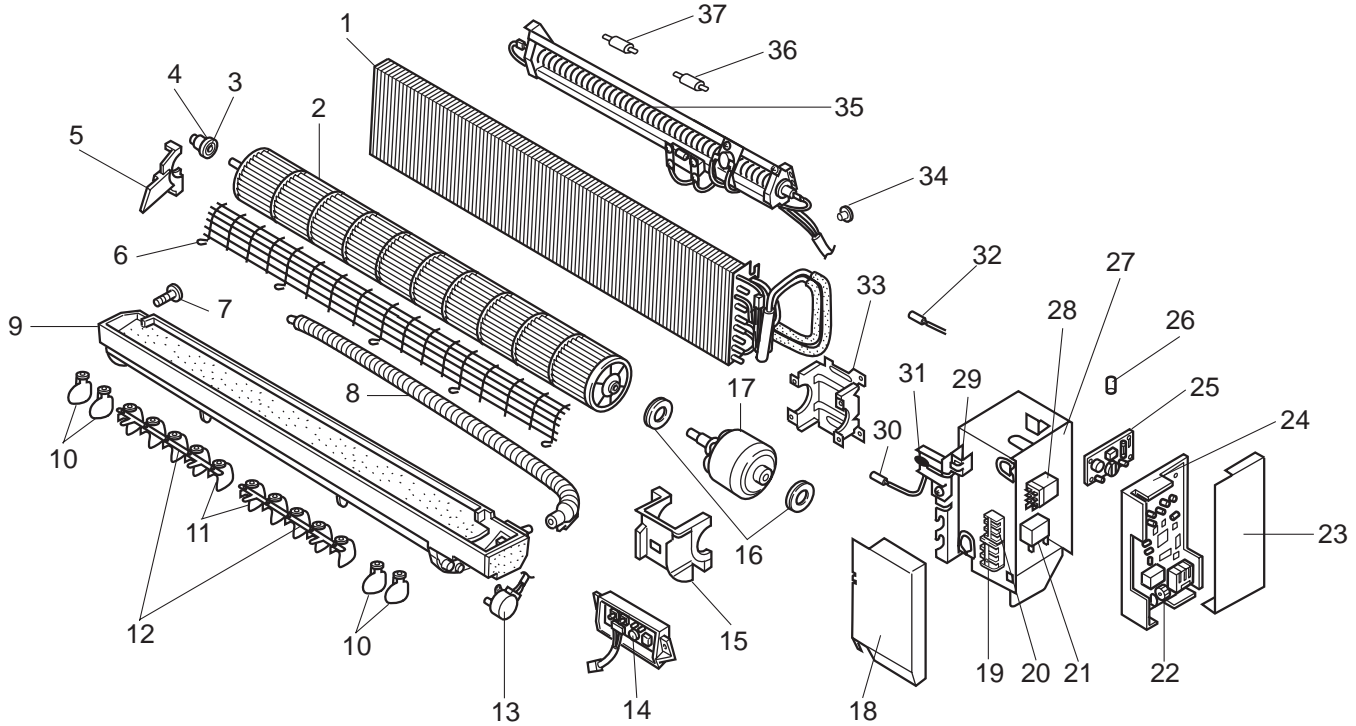

No.	Parts No.	Parts Name	Specifications	PKH-	PKA-	Remarks (Drawing No.)	Wiring Diagram Symbol	Recom- mended Q'ty	Price	
				P35 / P50 GALH	RP35 / RP50 GAL				Unit	Amount
1	R01 E48 480	HEAT EXCHANGER		1						
	T7W E56 480	HEAT EXCHANGER			1					
2	R01 09Y 114	LINE FLOW FAN		1						
	R01 07Y 114	LINE FLOW FAN			1					
3	R01 07Y 102	BEARING MOUNT		1	1					
4	R01 005 103	SLEEVE BEARING		1	1					
5	R01 07Y 106	BEARING SUPPORT		1	1					
6	T7W A00 675	FAN GUARD		1	1					
7	R01 07Y 524	DRAIN PLUG		1	1					
8	R01 07Y 527	DRAIN HOSE		1	1					
9	R01 07Y 530	NOZZLE		1	1					
10	R01 09Y 038	GUIDE VANE		4	4					
11	R01 07Y 038	GUIDE VANE		10	10					
12	R01 07Y 059	ARM		2	2					
13	R01 E04 223	VANE MOTOR		1	1		MV			
14	R01 E03 317	WIRELESS ADAPTER CONTROLLER BOARD		1	1		W.B			
15	R01 07Y 135	MOTOR COVER		1	1					
16	R01 07Y 105	RUBBER MOUNT		2	2					
17	T7W A01 762	FAN MOTOR	PM4V30-K	1	1		MF			

To be continued on the next page.

From the preceding page.

Part numbers that is circled is not shown in the figure.

No.	Parts No.	Parts Name	Specifications	PKH-	PKA-	Remarks (Drawing No.)	Wiring Diagram Symbol	Recom- mended Q'ty	Price	
				P35 / P50 GALH	RP35 / RP50 GAL				Unit	Amount
18	—	TERMINAL COVER		1	1	(BG02V195H10)				
19	T7W A14 716	TERMINAL BLOCK	3P(L, N, ⊕)	1			TB2			
20	T7W E23 716	TERMINAL BLOCK	3P(S1, S2, S3)	1	1		TB4			
21	R01 588 255	CAPACITOR	2.0 μ F ×440V	1	1		C			
22	T7W E40 310	INDOOR CONTROLLER BOARD		1	1		I.B			
23	—	CONTROLLER COVER		1	1	(BG02V194G01)				
24	—	CONTROLLER CASE		1	1	(BG25B573H06)				
25	R01 E02 313	POWER BOARD		1	1		P.B			
26	R01 E02 239	FUSE	250V 6.3A	1	1		FUSE			
27	—	ELECTRICAL PARTS COVER		1	1	(BG00V196G41)				
28	R01 71G 215	HEATER CONTACTOR		1			88H			
29	—	SENSOR HOLDER		1	1	(RG25C546H06)				
30	R01 E58 202	CONDENSER / EVAPORATOR TEMPERATURE THERMISTOR		1	1		TH5			
31	T7W E05 202	ROOM TEMPERATURE THERMISTOR		1	1		TH1			
32	R01 E02 202	PIPE TEMPERATUER THERMISTOR		1	1		TH2			
33	R01 07Y 130	MOTOR SUPPORT		1	1					
34	R01 64K 700	HEATER THERMAL SWITCH	60°C OFF 40°C ON	1			26H			
35	T7W E13 300	HEATER ELEMENT	800W	1			H1			
36	R01 986 706	THERMAL FUSE	104°C 10A	1			FS1			
37	R01 208 706	THERMAL FUSE	84°C 10A	1			FS2			
③8	R01 20J 303	INSULATOR		1						

STRUCTURAL PARTS
PKH-P35GALH, PKA-RP35GAL
PKH-P50GALH, PKA-RP50GAL

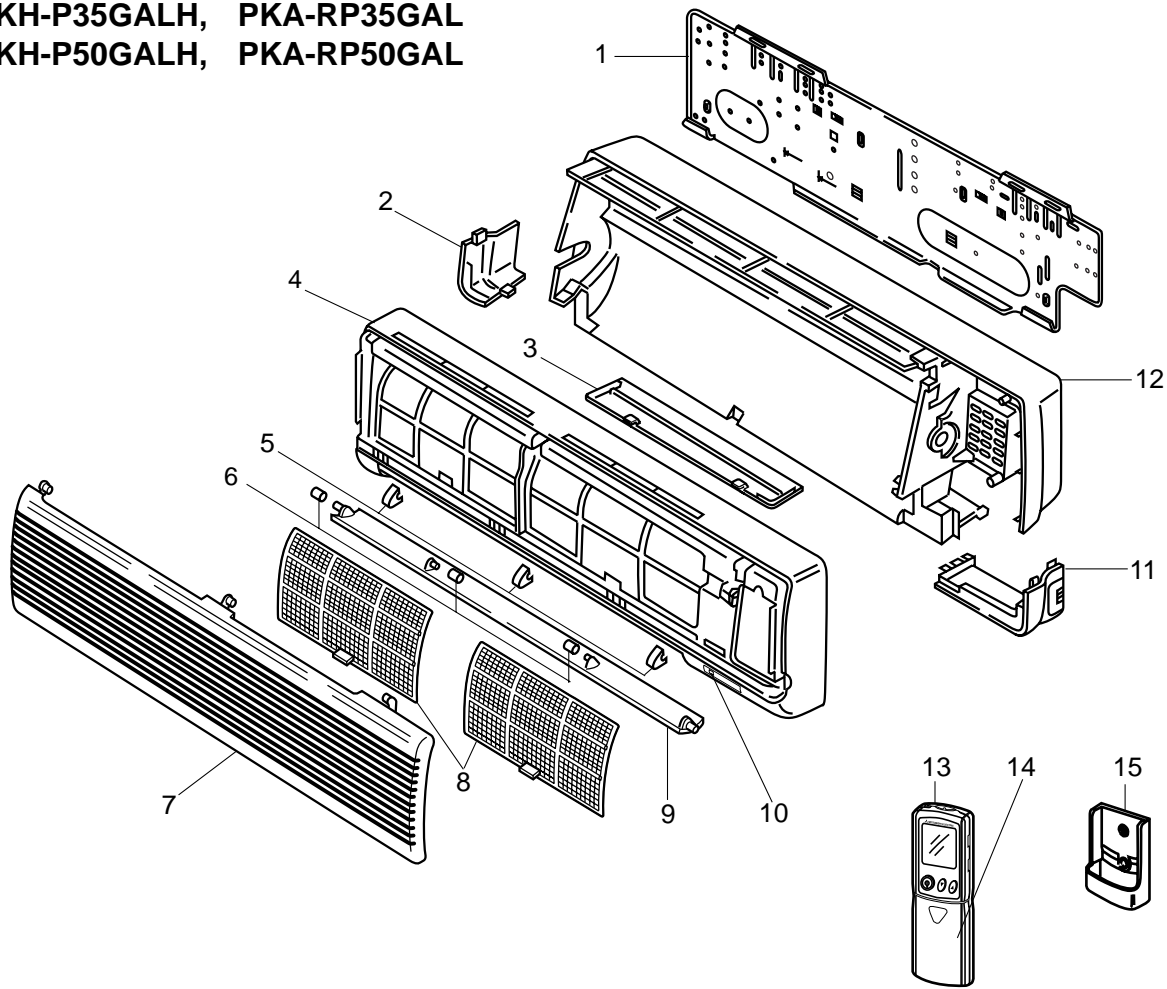

No.	Parts No.	Parts Name	Specifications	PKH-	PKA-	Remarks (Drawing No.)	Wiring Diagram Symbol	Recom- mended Q'ty	Price	
				P35 / P50 GALH	RP35 / RP50 GAL				Unit	Amount
1	R01 07Y 808	BACK PLATE		1	1					
2	R01 09Y 658	CORNER COVER		1	1					
3	R01 07Y 623	UNDER COVER		1	1					
4	R01 89Y 651	FRONT PANEL		1	1					
5	R01 07Y 096	SCREW CAP		3	3					
6	R01 07Y 092	VANE SLEEVE		1	1					
7	R01 07Y 691	FRONT GRILLE		1	1					
8	R01 A16 500	AIR FILTER		2	2					
9	R01 07Y 002	AUTO VANE		1	1					
10	R01 24K 658	RECEIVING UNIT		1	1		RU			
11	R01 07Y 658	CORNER COVER		1	1					
12	R01 09Y 635	BOX ASSEMBLY		1						
	R01 07Y 635	BOX ASSEMBLY			1					
13	T7W E06 714	WIRELESS REMOTE CONTROLLER		1	1					
14	R01 E01 049	WIRELESS REMOTE CONTROLLER DOOR		1	1					
15	R01 E00 075	WIRELESS REMOTE CONTROLLER HOLDER		1	1					

STRUCTURAL PARTS

PKH-P35GALH, PKA-RP35GAL

PKH-P50GALH, PKA-RP50GAL

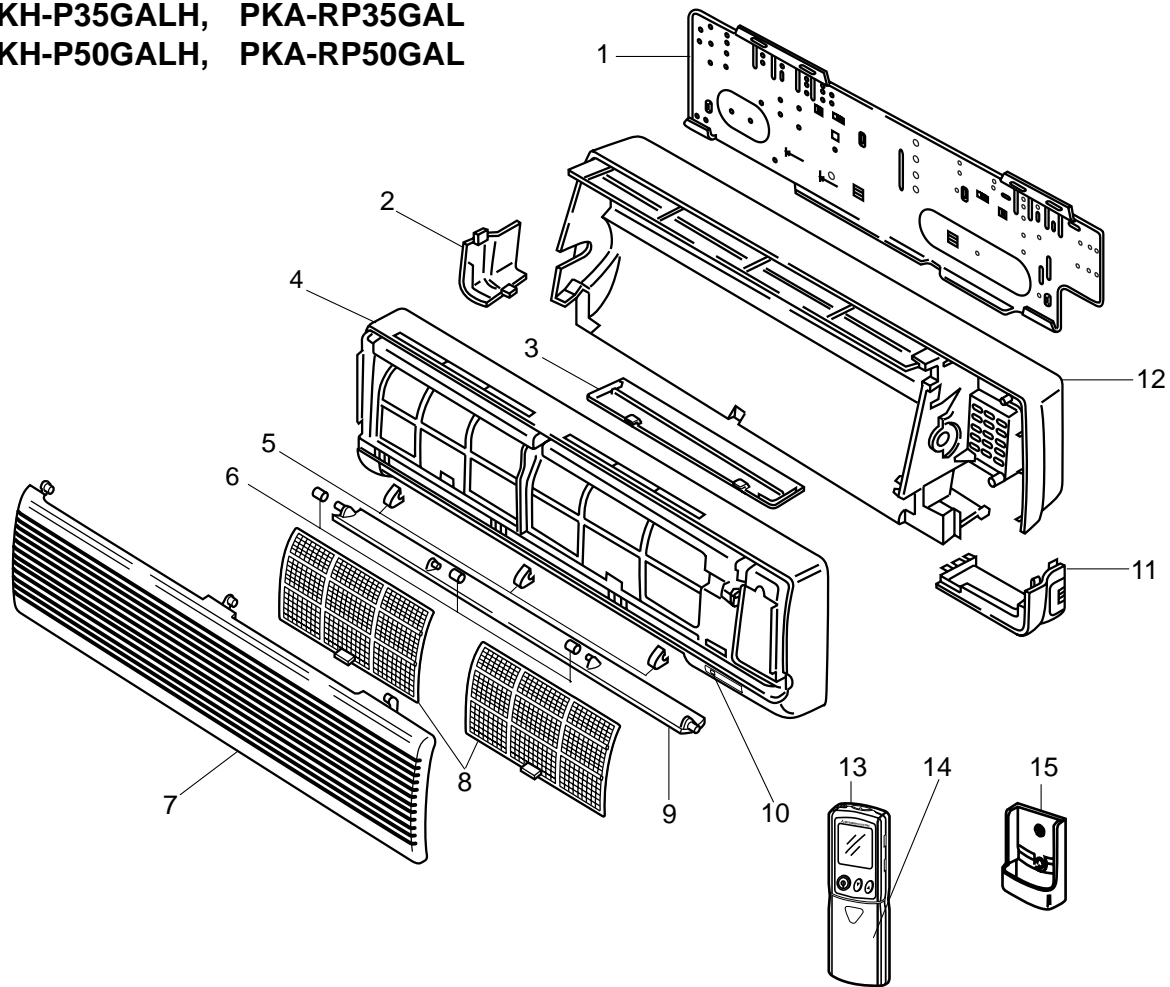

No.	RoHS	Parts No.	Parts Name	Specifications	PKH-	PKA-	Remarks (Drawing No.)	Wiring Diagram Symbol	Recom- mended Q'ty	Price	
					P35 / P50 GALH	RP35 / RP50 GAL				Unit	Amount
1	G	R01 08Y 808	BACK PLATE		1	1					
2	G	R01 10Y 658	CORNER COVER (R)		1	1					
3	G	R01 08Y 623	UNDER COVER		1	1					
4	G	R01 E05 651	FRONT PANEL		1	1					
5	G	R01 08Y 096	SCREW CAP		3	3					
6	G	R01 08Y 092	VANE SLEEVE		1	1					
7	G	R01 08Y 691	FRONT GRILLE		1	1					
8	G	R01 A16 500	AIR FILTER		2	2					
9	G	R01 08Y 002	AUTO VANE		1	1					
10	G	R01 E18 658	RECEIVING UNIT		1	1		RU			
11	G	R01 08Y 658	CORNER COVER (L)		1	1					
12	G	R01 10Y 635	BOX ASSEMBLY		1						
	G	R01 08Y 635	BOX ASSEMBLY			1					
13	G	T7W E10 714	WIRELESS REMOTE CONTROLLER		1	1					
14	G	R01 E03 049	WIRELESS REMOTE CONTROLLER DOOR		1	1					
15	G	R01 E00 075	WIRELESS REMOTE CONTROLLER HOLDER		1	1					

ELECTRICAL PARTS
PKH-P35GALH, PKA-RP35GAL
PKH-P50GALH, PKA-RP50GAL

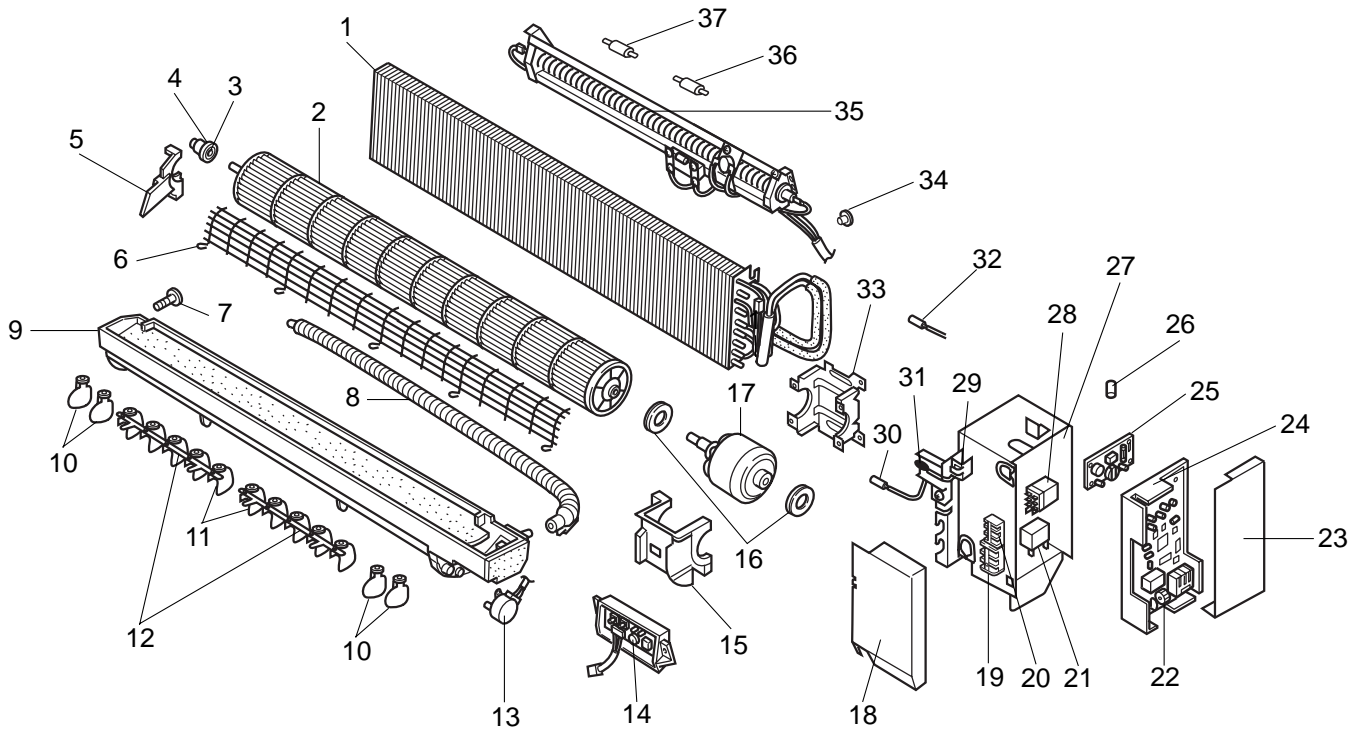

No.	RoHS	Parts No.	Parts Name	Specifications	PKH-	PKA-	Remarks (Drawing No.)	Wiring Diagram Symbol	Recom- mended Q'ty	Price	
					P35 / P50 GALH	RP35 / RP50 GAL				Unit	Amount
1	G	R01 E70 480	HEAT EXCHANGER		1						
	G	T7W H36 480	HEAT EXCHANGER			1					
2	G	R01 E21 114	LINE FLOW FAN		1						
	G	R01 E22 114	LINE FLOW FAN			1					
3	G	R01 08Y 102	BEARING MOUNT		1	1					
4	G	R01 E04 103	SLEEVE BEARING		1	1					
5	G	R01 08Y 106	BEARING SUPPORT		1	1					
6	G	T7W A01 675	FAN GUARD		1	1					
7	G	R01 08Y 524	DRAIN PLUG		1	1					
8	G	R01 08Y 527	DRAIN HOSE		1	1					
9	G	R01 08Y 530	NOZZLE		1	1					
10	G	R01 10Y 038	GUIDE VANE		4	4					
11	G	R01 08Y 038	GUIDE VANE		10	10					
12	G	R01 08Y 059	ARM		2	2					
13	G	R01 E14 223	VANE MOTOR		1	1		MV			
14	G	R01 E06 317	WIRELESS ADAPTER CONTROLLER BOARD		1	1		W.B			
15	G	R01 08Y 135	MOTOR COVER		1	1					
16	G	R01 08Y 105	RUBBER MOUNT		2	2					
17	G	T7W A02 762	FAN MOTOR	PM4V30-K	1	1		MF			

To be continued on the next page.

From the preceding page.

Part numbers that is circled is not shown in the figure.

No.	RoHS	Parts No.	Parts Name	Specifications	PKH-	PKA-	Remarks (Drawing No.)	Wiring Diagram Symbol	Recom- mended Q'ty	Price	
					P35 / P50 GALH	RP35 / RP50 GAL				Unit	Amount
18	G	—	TERMINAL COVER		1	1	(BG02V195H10)				
19	G	T7W E32 716	TERMINAL BLOCK	3P(L, N, ⊕)	1			TB2			
20	G	R01 E20 246	TERMINAL BLOCK	3P(S1, S2, S3)	1	1		TB4			
21	G	R01 E13 255	CAPACITOR	2.0 μ F X440V	1	1		C			
22	G	T7W E50 310	INDOOR CONTROLLER BOARD		1	1		I.B			
23	G	—	CONTROLLER COVER		1	1	(BG02V194G01)				
24	G	—	CONTROLLER CASE		1	1	(BG25B573H06)				
25	G	R01 E38 313	POWER BOARD		1	1		P.B			
26	G	R01 E06 239	FUSE	250V 6.3A	1	1		FUSE			
27	G	—	ELECTRICAL PARTS COVER		1	1	(BG00V196G47)				
28	G	R01 E03 215	HEATER CONTACTOR		1			88H			
29	G	—	SENSOR HOLDER		1	1	(RG25C546H06)				
30	G	R01 H05 202	CONDENSER / EVAPORATOR TEMPERATURE THERMISTOR		1	1		TH5			
31	G	R01 H08 202	ROOM TEMPERATURE THERMISTOR		1	1		TH1			
32	G	R01 H11 202	PIPE TEMPERATUER THERMISTOR		1	1		TH2			
33	G	R01 08Y 130	MOTOR SUPPORT		1	1					
34	G	R01 E11 700	HEATER THERMAL SWITCH	60°C OFF 40°C ON	1			26H			
35	G	T7W E18 300	HEATER ELEMENT	800W	1			H1			
36	G	R01 E00 706	THERMAL FUSE	104°C 10A	1			FS1			
37	G	R01 E01 706	THERMAL FUSE	84°C 10A	1			FS2			
38	G	R01 31J 303	INSULATOR		1						

Mr. SLIM™

 **MITSUBISHI ELECTRIC CORPORATION**

HEAD OFFICE : TOKYO BLDG., 2-7-3, MARUNOUCHI, CHIYODA-KU, TOKYO 100-8310, JAPAN